



INSTRUCTION MANUAL

Multi Language
Manual
QR code



TOUCH SWITCHES & SOCKETS
(GLASS SERIES)

Sockets Installation:

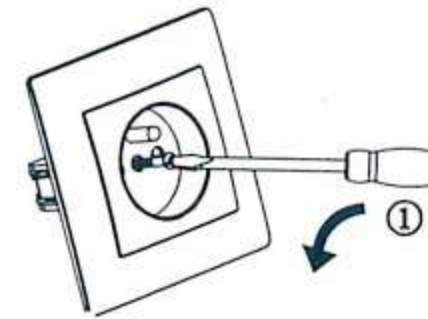

2 pin socket with earth
step:1



step:2

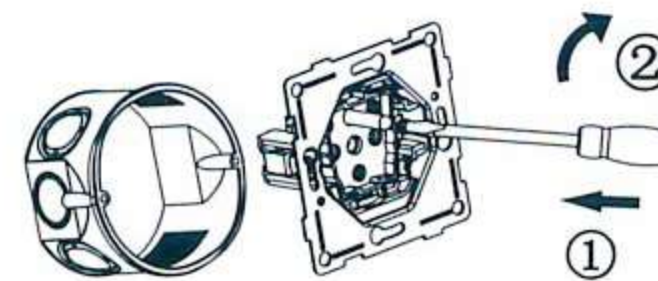

step:3

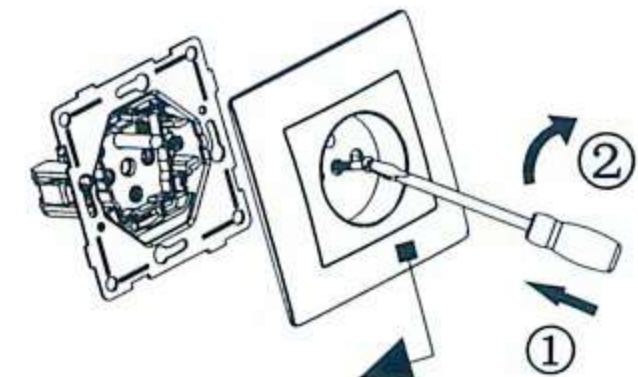

step:4

TOUCH SWITCHES INSTALLATION ..

The Touch Switches is designed to be recessed installation, which need to be installed with the embedded box in the Wall. The following wire method is suitable for the Touch Switches with 1gang/2gang. These switches can be directly replaced with any mechanical switch..

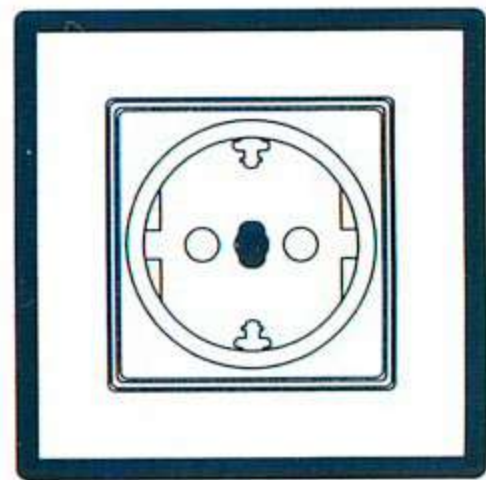

16A 250V
2 pin socket

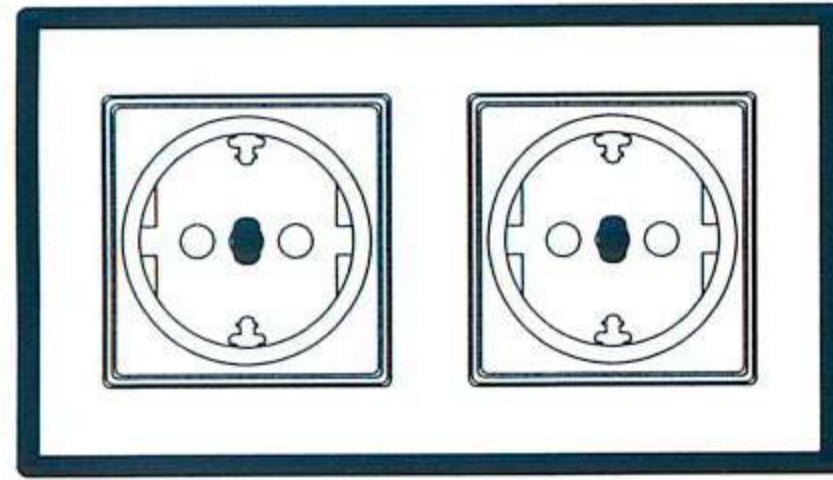

16A 250V
Double 2 pin socket

One way switch

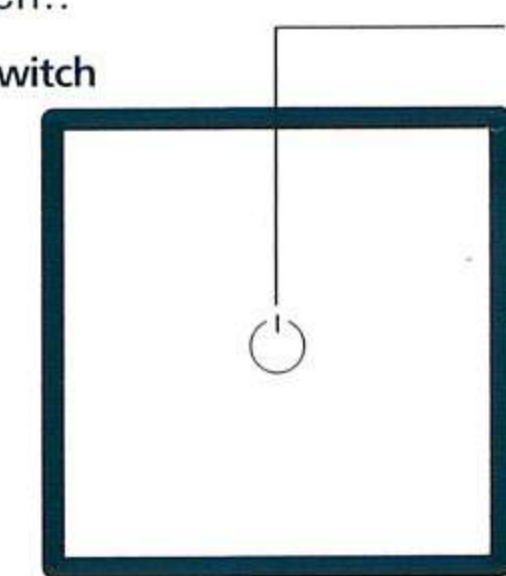

Live lines connect to L-IN

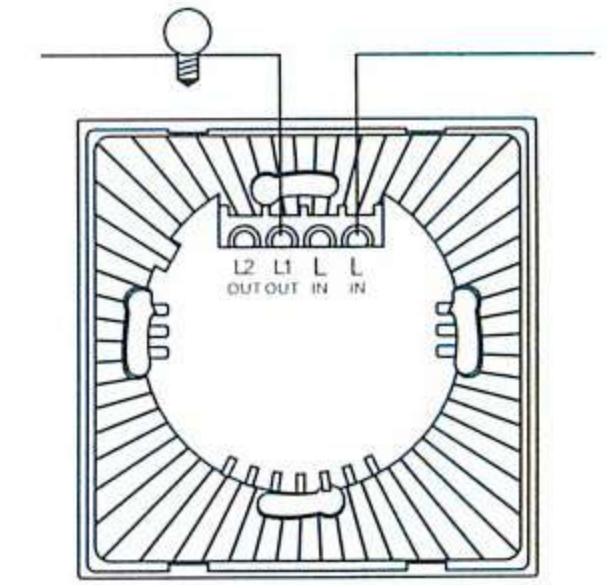

Loading lamps connect to L-out

Two ways switch

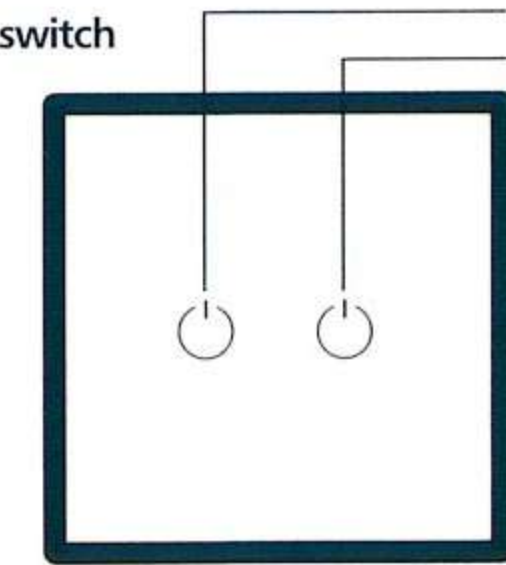

Live lines connect to L-IN Loading lamps connect to L1, L2 Separately

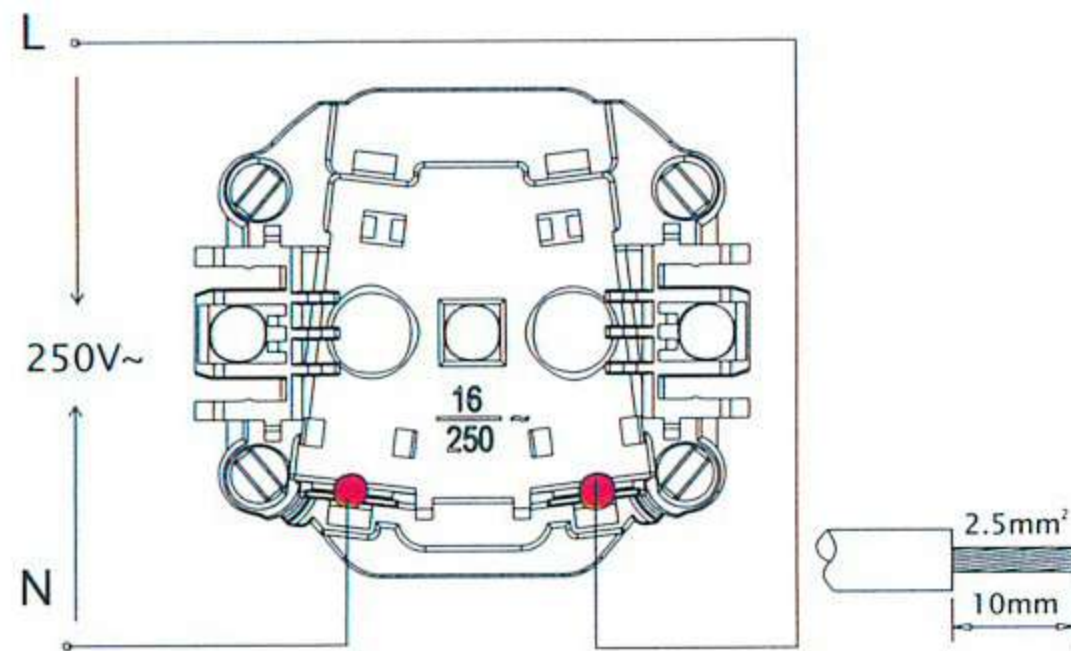
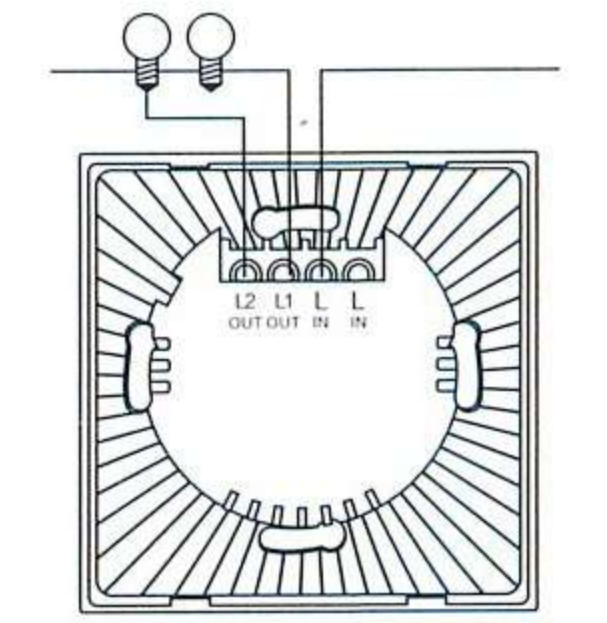

Doorbell switch

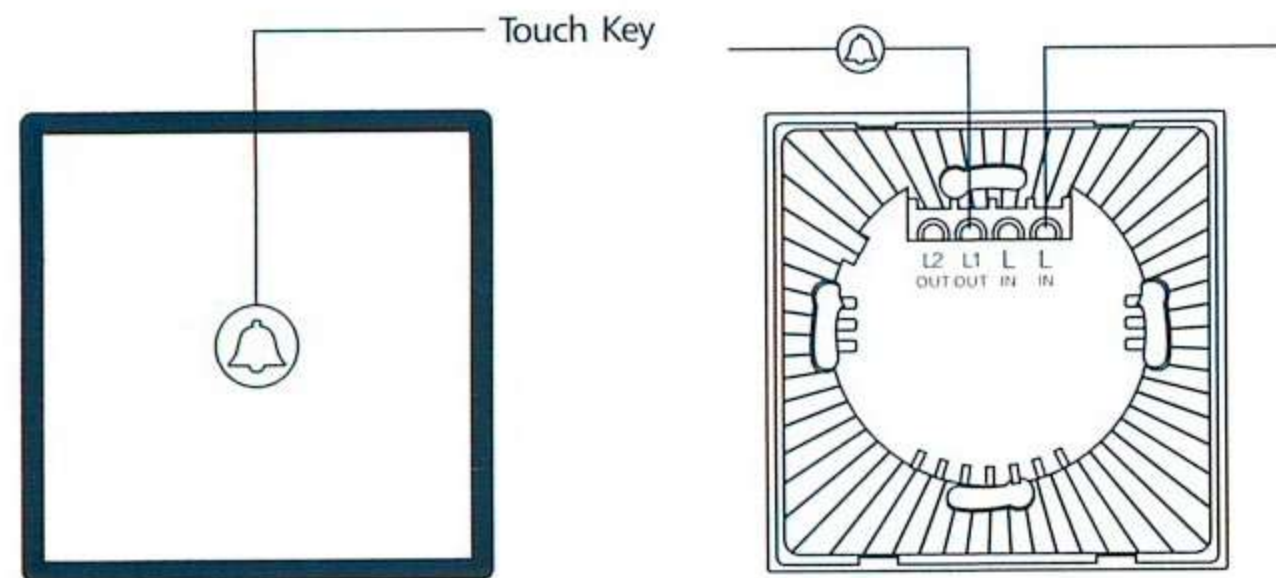

Live lines connect to L-IN

Loading lamps connect to L-out

⚠ Caution

This switch is strictly prohibited from being installed with electricity. After installation, the surface panel should be fixed before power ON. After power ON, the switch's Intelligent Processors will start self-checking and make Environment adaptation, as well Parameter initialization within 15 seconds. Please do not touch the switch during this time. After power ON for 15 seconds, the self-checking initialization is finished, and the switch can be formally used.

1、 Rated operational voltage: 220-240VAC. operating frequency: 50/60Hz.
The performance tolerance: -15%~+10% 187-264V.

2、 Loading Power:

Single Circuit :

Resistive load (incandescent bulbs) maximum is 1000W,
capacitive load (Electronic ballast fluorescent lamp--Energy saving lamps /LED lamps etc.)
and Inductive load (Transformer-magnetic driven load, motor) maximum is 500W;
minimum is 5W.

Double Circuits:

Total resistive load maximum is 2000W, each Circuit \leq 1000W,
Capacitive load and inductive load maximum is 500W; minimum is 5W.

Triple Circuits:

Total resistive load maximum is 2000W, each Circuit \leq 1000W,
(total load of triple Circuit \leq 2000W) ,
Capacitive load and Inductive load of each Circuit maximum is 500w
(total load of Triple Circuits \leq 1000W) ; each Circuit minimum is 5W.

3、 Working Environment: Working Temperature: 0°C-40°C

Relative Humidity : 10% -93% (Non-Condensing)

4、 Product Dimension: 86 x86mm

This product complies with the requirements of
GB16915.2(IEC60669-2-1),

TUV CE standard, and SII standard

In case of few low power LED lamps (less than 5W) or other light sources are not compatible with this switch, or when the switch control the magnetic ballast fluorescent lamp, the fluorescent lamps have Flicking phenomenon or has the phenomenon that fluorescent lamps turn off automatically after switch on, the adapter parts provided by the manufacturer shall be connected in parallel at both ends of the lamp (both L and N wires of the lamps)the adapter parts are provided by the manufacturer for free)

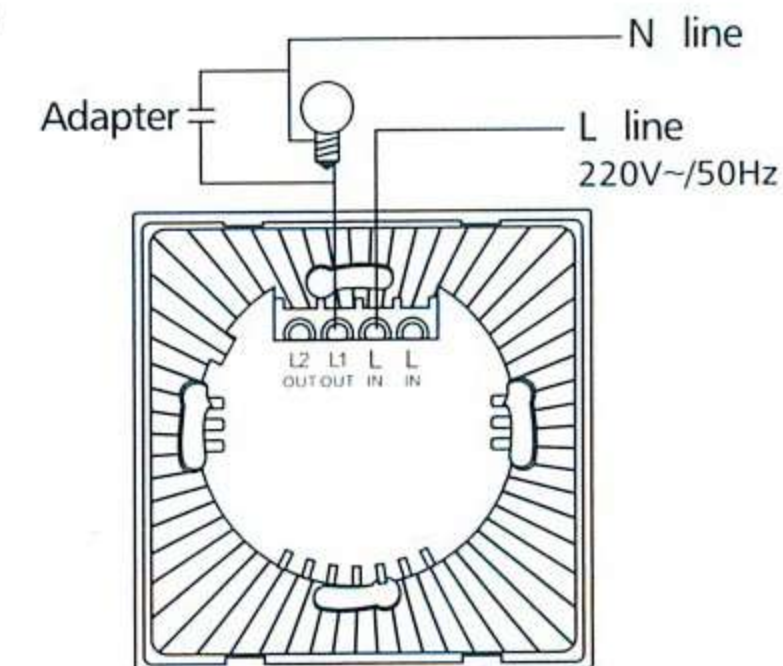

1. Switches' Backlight instruction

The Touch screen switches are with backlight indication, it will be convenient for the users to find the switches easily when the light is off at night. The backlight indication is LED in two colors, it is blue when the switch is off (Keep the backlight as low as possible when it is switch off) , and red when it is on.

2. Cautions

- ①.Do not mix different loads in the same circuit , Do not connect to the same circuit with a mechanical switch
- ②.It is normal if you feel warm when you touch the surface glass panel during the working condition of the switch .
In order to optimizing the best operation performance, the main power supply should be free from any noise and strong interference, especially should be free from the peak voltage of over 425V and other high-frequency noises.
- ③.Before debugging, please be sure there is no short circuit in the line to avoid the switch in damage caused by short circuit.
- ④.Before the insulation test of the circuit, please remove the touch screen switch from the circuit. Otherwise, it is easy to cause the failure or damage of the product.
- ⑤.Please use standard embedded box when installing the product. Do not use metal embedded box because it may affect the remote distance or cause electric shock hazard..
- ⑥.The distance between the switch and the load(lamp or any others controlled by this switch shall be more than 0.5m, to avoid the interference caused by the load.

3. Common fault diagnosis

Should you have problems when you are using the touch screen switches, please follow the bellow steps to check:

- ①.Touch screen switch has no function and cannot switch lamps:
Maybe there is no electricity, please power ON the switch after checking;
Maybe it is self-check error or the self-check is not successful , please power OFF the switch and then power ON the switch for 15 seconds to operate.
Maybe Input and output lines are not properly connected, Please reloaded after checking.
Maybe the connected load is the fluorescent lamp driven by Magnetic ballast or some low power LED lamps, then the switch cannot control the load(lamps), please install the adapter parts provided by the manufacturer and test again.

②.The lamp turned on after switch ON, it is because the lamp power is too small, please replace it to be higher power lamp(higher than 5W), or install the adapter parts provided by the manufacturer.

If not, maybe the power supply voltage is too low, the lowest working voltage shall be guaranteed after inspection

Maybe the switch is damaged.

③.It is normal phenomenon if cannot switch on the lamp immediately after power ON or when power recalling. It needs about 15 seconds for self-test initialization after power ON. It can be normal use after 15 seconds.

④.One Circuit of the multiway switch cannot work;

Maybe the Circuit that cannot be operated is not loaded or the load is damaged;
Maybe the switch is damage.

⑤.Can not remote the controller;

Maybe the code is not matched with the switch, please make the registration as per the code operation instructions;

Maybe there is Strong electromagnetic interference. The switch should be used where the EMI is weak

Maybe the battery of remote controller is not installed or the battery power is low. Please check or replace the same type of battery;

Maybe the remote distance is too far and beyond the remote effective distance.

⑥.Occasional remote control malfunction;

Maybe there are short bursts of intense electromagnetic interference.

⑦.The switch will turn ON or OFF automatically and fail to touch controlling ;

Maybe it is because the distance between the switch and the capacitance type sensitive electromagnetic compatibility is too short, and the lamps cause Intense electromagnetic interference to the switch. Maybe the switch is damage.

4. Warranty

①.Under the normal condition , the manufacturer provides the Main part of this Switch (except the surface panel) for replacement within the 5 years warranty period, and offers the Quality assurance of lifetime maintenance beyond the 5 years warranty period.

②.The following situations are not covered by warranty:

- (1).Damage caused by man-made or external factors such as water ingress.
- (2)The users have disassembled or refitted the main part of the product by themselves.
- (3)The product is used by exceeding the product's technical parameter.
- (4)Loss due to force majeure, such as earthquake or fire etc.



Multi Language
Manual
QR code



1 Gang 2 way switch(VT-5121)

