



APPLICATION FOR EMC DIRECTIVE

On Behalf of

V-TAC EXPORTS LIMITED

LED LINEAR LIGHT - TRUNKING

Trade Name: 

Model: VT-4549D, VT-4550D, VT-4551D

Prepared For : **V-TAC EXPORTS LIMITED**
ROOM NO.301, KANM ON BUILDING 176A QUEENS ROAD

Prepared By : **TMC Testing Services (Shenzhen) Co., Ltd.**

5/F, Building E, Guanghao Industrial Park, Yunfeng Road, Longhua District, Shenzhen, Guangdong, P.R. China

Tel: +86-755- 86642861

Web: www.tmc-lab.com

E-mail: Cert@tmc-lab.com

Date of Test: July 18-19, 2017

Date of Report: August 8, 2017

Report Number: TMC170804109-E

TABLE OF CONTENTS

TEST REPORT DECLARATION.....	5
1. TEST RESULTS SUMMARY.....	6
2. GENERAL INFORMATION.....	7
2.1. Report information.....	7
2.2. Measurement Uncertainty.....	7
3. PRODUCT DESCRIPTION.....	8
3.1. EUT Description.....	8
3.2. Block Diagram of EUT Configuration.....	8
3.3. Operating Condition of EUT.....	8
3.4. Test Conditions.....	8
3.5. Modifications.....	8
3.6. Abbreviations.....	9
3.7. Performance Criterion.....	9
4. TEST EQUIPMENT USED.....	10
4.1. For Conducted Emission Test.....	10
4.2. For Magnetic Test (In Shielding Room).....	10
4.3. For Harmonic / Flicker Test.....	10
4.4. For Electrostatic Discharge Immunity Test.....	10
4.5. For RF Strength Susceptibility Test.....	10
4.6. For Electrical Fast Transient/Burst Immunity Test.....	10
4.7. For Surge Test.....	10
4.8. For Injected Currents Susceptibility Test.....	11
4.9. For Magnetic Field Immunity Test.....	11
4.10. For Voltage Dips and Interruptions Test.....	11
5 RADIATED EMISSION TEST.....	12
5.1 Test Standard.....	12
5.1 Radiated Emission Limit.....	12
5.2 EUT Configuration on Test.....	12
5.3 Operating Condition of EUT.....	13
5.4 Test Procedure.....	13
5.5 Test Results.....	13
6. POWER LINE CONDUCTED EMISSION TEST.....	14
6.1. Block Diagram of Test Setup.....	14
6.2. Test Standard.....	14
6.3. Power Line Conducted Emission Limit.....	14
6.4. EUT Configuration on Test.....	14
6.5. Operating Condition of EUT.....	15
6.6. Test Procedure.....	15
6.7. Test Result.....	15
7. MAGNETIC TEST.....	16
7.1. Block Diagram of Test Setup.....	16
7.2. Test Standard.....	16
7.3. Magnetic Field Emission Limits.....	16
7.4. EUT Configuration on Test.....	16
7.5. Operating Condition of EUT.....	16
7.6. Test Procedure.....	17

7.7. Test Results	17
8. HARMONIC CURRENT EMISSION TEST	18
8.1. Block Diagram of Test Setup	18
8.2. Test Standard.....	18
8.3. Operating Condition of EUT	18
8.4. Test Procedure.....	18
8.5. Test Results	18
9. VOLTAGE FLUCTUATIONS & FLICKER TEST.....	19
9.1. Block Diagram of Test Setup	19
9.2. Test Standard.....	19
9.3. Operating Condition of EUT	19
9.4. Test Data.....	19
9.5. Test Results	19
10. ELECTROSTATIC DISCHARGE TEST.....	20
10.1. Block Diagram of ESD Test Setup.....	20
10.2. Test Standard.....	20
10.3. Severity Levels and Performance Criterion.....	20
10.4. EUT Configuration on Test.....	20
10.5. Operating Condition of EUT	21
10.6. Test Procedure.....	21
10.7. Test Results	21
11. RF FIELD STRENGTH SUSCEPTIBILITY TEST.....	23
11.1. R/S Test Setup	23
11.2. Test Standard.....	23
11.3. Severity Levels and Performance Criterion.....	23
11.4. EUT Configuration on Test.....	23
11.5. Operating Condition of EUT	24
11.6. Test Procedure.....	24
11.7. Test Results	24
12. ELECTRICAL FAST TRANSIENT/BURST TEST.....	26
12.1. EFT Test Setup	26
12.2. Test Standard.....	26
12.3. Severity Levels and Performance Criterion.....	26
12.4. EUT Configuration on Test.....	26
12.5. Operating Condition of EUT	26
12.6. Test Procedure.....	27
12.7. Test Results	27
13. SURGE TEST.....	29
13.1. Surge Test Setup.....	29
13.2. Test Standard.....	29
13.3. Severity Levels and Performance Criterion.....	29
13.4. EUT Configuration on Test.....	29
13.5. Operating Condition of EUT	29
13.6. Test Procedure.....	29
13.7. Test Results	30
14. INJECTED CURRENTS SUSCEPTIBILITY TEST	32
14.1. Block Diagram of Test AC Mains Setup.....	32
14.2. Test Standard.....	32
14.3. Severity Levels and Performance Criterion.....	32
14.4. EUT Configuration on Test.....	32
14.5. Operating Condition of EUT	32

14.6. Test Procedure	32
14.7. Test Results	33
15. MAGNETIC FIELD IMMUNITY TEST	35
15.1. Block Diagram of Test Setup	35
15.2. Test Standard	35
15.3. Severity Levels and Performance Criterion	35
15.4. EUT Configuration on Test	35
15.5. Operating Condition of EUT	36
15.6. Test Procedure	36
15.7. Test Results	36
16. VOLTAGE DIPS AND INTERRUPTIONS TEST	38
16.1. Voltage Dips and Interruptions Test Setup	38
16.2. Test Standard	38
16.3. Severity Levels and Performance Criterion	38
16.4. EUT Configuration on Test	38
16.5. Operating Condition of EUT	38
16.6. Test Procedure	39
16.7. Test Result	39

TEST REPORT DECLARATION

Applicant	V-TAC EXPORTS LIMITED
Address	ROOM NO.301, KANM ON BUILDING 176A QUEENS ROAD
EUT Description	: LED LINEAR LIGHT - TRUNKING
Model Number	: VT-4549D, VT-4550D, VT-4551D

Test Standards:

- EN 55015:2013
- EN 61547:2009
- EN 61000-3-2:2014
- EN 61000-3-3:2013

The EUT described above is tested by TMC Testing Services (Shenzhen) Co., Ltd. EMC Laboratory to determine the maximum emissions from the EUT and ensure the EUT to be compliance with the immunity requirements of the EUT. TMC Testing Services (Shenzhen) Co., Ltd. EMC Laboratory is assumed full responsibility for the accuracy of the test results. Also, this report shows that the EUT technically complies with the 2014/30/EU directive and its amendment requirements.

The test report is valid for above tested sample only and shall not be reproduced in part without written approval of the laboratory.

All test results and data in the report are from the report TMC170717101-E. This report is just a copy report; the EUT is as same as tested in TMC170717101-E.

Prepared by :

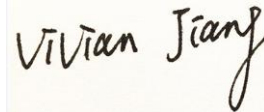

Vivian Jiang/ Assistant

Reviewer :



Mike Mo/ Supervisor

Approved & Authorized Signer :

Lemon/ Manager

1. TEST RESULTS SUMMARY

Table 1 Test Results Summary

Test Items	Test Results
Conducted emission test	PASS
Radiated Emission	PASS
Magnetic test	PASS
Harmonic Current	PASS
Voltage Fluctuation and Flicker	PASS
Electrostatic Discharge Test	PASS
RF Field Strength susceptibility Test	PASS
Electrical Fast Transient/Burst Test	PASS
Surge Test	PASS
Injected currents susceptibility test	PASS
Voltage dips and interruptions test	PASS

2. GENERAL INFORMATION

2.1. Report information

- 2.1.1. This report is not a certificate of quality; it only applies to the sample of the specific product/equipment given at the time of its testing. The results are not used to indicate or imply that they are applicable to the similar items. In addition, such results must not be used to indicate or imply that TMC approves, recommends or endorses the manufacture, supplier or use of such product/equipment, or that TMC in any way guarantees the later performance of the product/equipment.
- 2.1.2. The sample/s mentioned in this report is/are supplied by Applicant, TMC therefore assumes no responsibility for the accuracy of information on the brand name, model number, origin of manufacture or any information supplied.
- 2.1.3. Additional copies of the report are available to the Applicant at an additional fee. No third party can obtain a copy of this report through TMC, unless the applicant has authorized TMC in writing to do so.

2.2. Measurement Uncertainty

Available upon request.

3. PRODUCT DESCRIPTION

3.1. EUT Description

Description	:	LED LINEAR LIGHT - TRUNKING
Applicant	:	V-TAC EXPORTS LIMITED ROOM NO.301, KANM ON BUILDING 176A QUEENS ROAD
Manufacturer	:	V-TAC EXPORTS LIMITED ROOM NO.301, KANM ON BUILDING 176A QUEENS ROAD
Model Number	:	VT-4549D

3.2. Block Diagram of EUT Configuration



3.3. Operating Condition of EUT

Test mode 1: Lighting

3.4. Test Conditions

Temperature: 23-26°C

Relative Humidity: 55-68 %

3.5. Modifications

No modification was made.

3.6. Abbreviations

AC	Alternating Current
AMN	Artificial Mains Network
DC	Direct Current
EM	ElectroMagnetic
EMC	ElectroMagnetic Compatibility
EUT	Equipment Under Test
IF	Intermediate Frequency
RF	Radio Frequency
rms	root mean square
EMI	Electromagnetic Interference
EMS	Electromagnetic Susceptibility

3.7. Performance Criterion

Criterion A: The equipment shall continue to operate as intended without operator intervention. No degradation of performance or loss of function is allowed below a performance level specified by the manufacturer when the equipment is used as intended.

Criterion B: After the test, the equipment shall continue to operate as intended without operator intervention. No degradation of performance or loss of function is allowed, after the application of the phenomena below a performance level specified by the manufacturer, when the equipment is used as intended.

Criterion C: Loss of function is allowed, provided the function is self-recoverable, or can be restored by the operation of the controls by the user in accordance with the manufacturer's instructions.

4. TEST EQUIPMENT USED

4.1. For Conducted Emission Test

Item	Equipment	Manufacturer	Model No.	Serial No.	Last Cal.	Cal. Interval
1.	Test Receiver	Rohde & Schwarz	ESHS30	828985/018	April 20, 17	1 Year
2.	Pulse Limiter	Rohde & Schwarz	ESH3-Z2	100006	April 20, 17	1 Year
3.	L.I.S.N.	Rohde & Schwarz	ESH2-Z5	834549/005	April 20, 17	1 Year
4.	Voltage Probe	Schwarzbeck	TK9416	N/A	April 20, 17	1 Year
5.	Coaxial Switch	Anritsu	MP59B	6100214550	April 20, 17	1 Year

4.2. For Magnetic Test (In Shielding Room)

Item	Equipment	Manufacturer	Model No.	Serial No.	Last Cal.	Cal. Interval
1.	Test Receiver	Rohde & Schwarz	ESHS20	836600/006	April 20, 17	1 Year
2.	Triple-loop Antenna	Rohde & Schwarz	HM020	843885/002	April 20, 17	1 Year
3.	RF Cable	MIYAZAKI	5D-2W	Tri-loop Cable	April 20, 17	1/2 Year
4.	Coaxial Switch	Anritsu	MP59B	M73989	April 20, 17	1/2 Year

4.3. For Harmonic / Flicker Test

Item	Equipment	Manufacturer	Model No.	Serial No.	Last Cal.	Cal. Interval
1.	Power Frequency test system	HAEFELY	PHF555	080419-03	April 20, 17	1 Year

4.4. For Electrostatic Discharge Immunity Test

Item	Equipment	Manufacturer	Model No.	Serial No.	Last Cal.	Cal. Interval
1.	ESD Tester	HAEFELY	PESD1600	H708159	April 20, 17	1 Year

4.5. For RF Strength Susceptibility Test

Item	Equipment	Manufacturer	Model No.	Serial No.	Last Cal.	Cal. Interval
1.	Signal Generator	HP	8648A	3633A02081	April 20, 17	1 Year
2.	Amplifier	A&R	500A100	17034	NCR	NCR
3.	Amplifier	A&R	100W/1000M1	17028	NCR	NCR
4.	Isotropic Field Monitor	A&R	FM2000	16829	NCR	NCR
5.	Isotropic Field Probe	A&R	FLW220100	16755	April 20, 17	1 Year
6.	Biconic Antenna	EMCO	3108	9507-2534	NCR	NCR
7.	Log-periodic Antenna	A&R	AT1080	16812	NCR	NCR
8.	PC	N/A	486DX2	N/A	N/A	N/A

4.6. For Electrical Fast Transient/Burst Immunity Test

Item	Equipment	Manufacturer	Model No.	Serial No.	Last Cal.	Cal. Interval
1.	Burst Tester	HAEFELY	PEFT 4010	080981-16	April 20, 17	1 Year

4.7. For Surge Test

Item	Equipment	Manufacturer	Model No.	Serial No.	Last Cal.	Cal. Interval
1.	Surge Tester	HAEFELY	PSURGE4.1	080107-04	April 20, 17	1 Year

4.8. For Injected Currents Susceptibility Test

Item	Equipment	Manufacturer	Model No.	Serial No.	Last Cal.	Cal. Interval
1.	Simulator	EMTEST	CWS 500C	0900-12	April 20, 17	1 Year
2.	CDN	EMTEST	CDN-M2	510010010010	April 20, 17	1 Year
3.	VDN	EMTEST	CDN-M3	0900-11	April 20, 17	1 Year
4.	Injection Clamp	EMTEST	F-2031-23MM	368	April 20, 17	1 Year
5.	Attenuator	EMTEST	ATT6	0010222A	April 20, 17	1 Year

4.9. For Magnetic Field Immunity Test

Item	Equipment	Manufacturer	Model No.	Serial No.	Last Cal.	Cal. Interval
1.	Magnetic Field Tester	HEAFELY	MAG100	250040.1	April 20, 17	1 Year

4.10. For Voltage Dips and Interruptions Test

Item	Equipment	Manufacturer	Model No.	Serial No.	Last Cal.	Cal. Interval
2.	Dips Tester	HEAFELY	Pline1610	083732-18	April 20, 17	1 Year

5 RADIATED EMISSION TEST

Open Site Setup Diagram

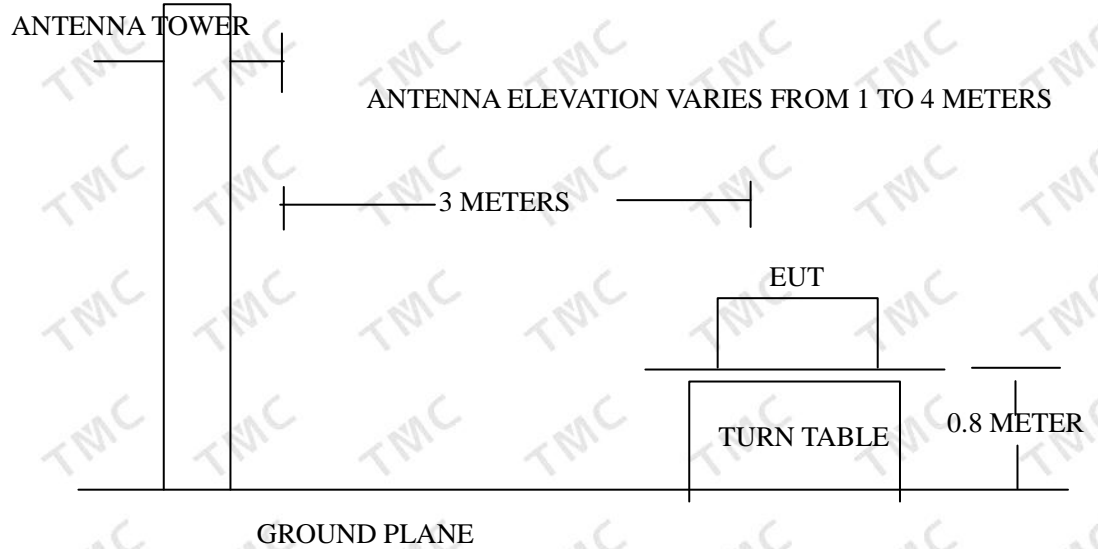

5.1 Test Standard

EN 55015:2013

5.1 Radiated Emission Limit

All emanations from a Class B computing devices or system, including any network of conductors and apparatus connected thereto, shall not exceed the level of field strengths specified below:

FREQUENCY (MHz)	DISTANCE (Meters)	FIELD STRENGTHS LIMITS (dB μ V/m)
30 ~ 230	3	40
230 ~ 1000	3	47

Note:(1) The tighter limit shall apply at the edge between two frequency bands.

(2) Distance refers to the distance in meters between the measuring instruments antenna and the closed point of any part of the EUT.

FREQUENCY (GHz)	DISTANCE (Meters)	Average limit (dB μ V/m)	Peak limit (dB μ V/m)
1 ~ 3	3	50	70
3 ~ 6	3	54	74

Note :The lower limit applies at the transition frequency.

5.2 EUT Configuration on Test

The EN55015 Class B regulations test method must be used to find the maximum emission during radiated emission test.

5.3 Operating Condition of EUT

- 5.3.1 Setup the EUT as shown on Section 5.1.
- 5.3.2 Turn on the power of all equipments.
- 5.3.3 Let the EUT work in test mode and measure it.

5.4 Test Procedure

The EUT is placed on a turn table which is 0.8 meter above ground. The turn table can rotate 360 degrees to determine the position of the maximum emission level. The EUT is set 3 meters away from the receiving antenna which is mounted on a antenna tower. The antenna can move up and down between 1 to 4 meters to find out the maximum emission level. Broadband antenna (calibrated by dipole antenna) are used as a receiving antenna. Both horizontal and vertical polarization of the antenna are set on test.

The bandwidth setting on the test receiver (R&S TEST RECEIVER ESCS20) is 120 KHz.

The EUT is tested in Anechoic Chamber. and all the scanning waveform is put in

Appendix I.

5.5 Test Results

PASS.

6. POWER LINE CONDUCTED EMISSION TEST

6.1. Block Diagram of Test Setup

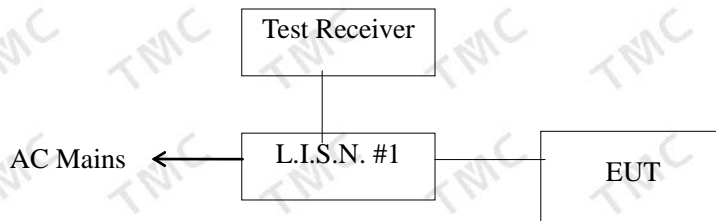

6.2. Test Standard

EN 55015:2013

6.3. Power Line Conducted Emission Limit

Frequency	At mains terminals (dB μ V)	
	Quasi-peak Level	Average Level
9KHz ~ 50KHz	110	--
50KHz ~ 150KHz	90 ~ 80*	--
150KHz ~ 0.5MHz	66 ~ 56*	56 ~ 46*
0.5MHz ~ 2.51MHz	56	46
2.51MHz ~ 3.0MHz	73	63
3.0MHz ~ 5.0MHz	56	46
5.0MHz ~ 30MHz	60	50

1. At the transition frequency the lower limit applies.
2. * decreasing linearly with logarithm of the frequency.

6.4. EUT Configuration on Test

The following equipments are installed on conducted emission test to meet EN55015 requirement and operating in a manner, which tends to maximize its emission characteristics in a normal application.

6.4.1. EUT information

Model Number: VT-4549D

Manufacturer: V-TAC EXPORTS LIMITED

6.5. Operating Condition of EUT

- 6.5.1. Setup the EUT and simulators as shown in Section 3.2.
- 6.5.2. Turn on the power of all equipments.
- 6.5.3. Let the EUT work in test modes (EUT WORKING) and test it.

6.6. Test Procedure

The EUT is put on the table which is 0.8 meter high above the ground and connected to the AC mains through a Line Impedance Stabilization Network (L.I.S.N.). This provided a 50ohm coupling impedance for the tested equipments. Both sides of AC line are checked to find out the maximum conducted emission according to the EN55015 regulations during conducted emission test. And the voltage probe had been used for the load terminals test according to the EN55015 standard.

The bandwidth of the test receiver (R&S ESHS20) is set at 10KHz. in 150KHz~30MHz and 200Hz bandwidth in 9KHz~150KHz.

The frequency range from 9KHz to 30MHz is checked.

All the test results are listed in Section 6.7. and all the scanning waveform is put in **Appendix II.**

6.7. Test Result

PASS

7. MAGNETIC TEST

7.1. Block Diagram of Test Setup

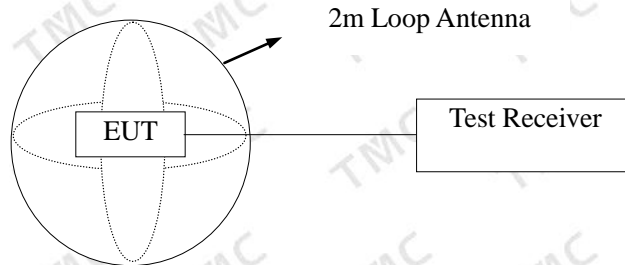

(EUT: LED LINEAR LIGHT - TRUNKING)

7.2. Test Standard

EN 55015:2013

7.3. Magnetic Field Emission Limits

Frequency	Limits for loop diameter (dB μ A)
	2m
9KHz ~ 70KHz	88
70KHz ~ 150KHz	88 ~ 58*
150KHz ~ 2.2MHz	58 ~ 26*
2.2MHz ~ 3.0MHz	58
3.0MHz ~ 30MHz	22

1. At the transition frequency the lower limit applies.
2. * decreasing linearly with logarithm of the frequency.

7.4. EUT Configuration on Test

The configuration of the EUT is same as Section 3.2..

7.5. Operating Condition of EUT

- 7.5.1. Setup the EUT as shown in Section 6.1.
- 7.5.2. Turn on the power of all equipments.
- 7.5.3. Let the EUT work in test mode (ON) and test it.

7.6. Test Procedure

The EUT is placed on a wood table in the center of a loop antenna. The induced current in the loop antenna is measured by means of a current probe and the test receiver. Three field components is checked by means of a coax switch.

The frequency range from 9KHz to 30MHz is investigated. The receiver is measured with the quasi-peak detector. For frequency band 9KHz to 150KHz, the bandwidth of the field strength meter (R&S test receiver ESHS20) is set at 200Hz. For frequency band 150KHz to 30MHz, the bandwidth is set at 10KHz.

All the test results are listed in Section 7.7.

7.7. Test Results

PASS.

The frequency range from 9KHz to 30MHz is investigated.

As the peak value is too low against the limit, so the Quasi-peak value has been omitted.

8. HARMONIC CURRENT EMISSION TEST

8.1. Block Diagram of Test Setup

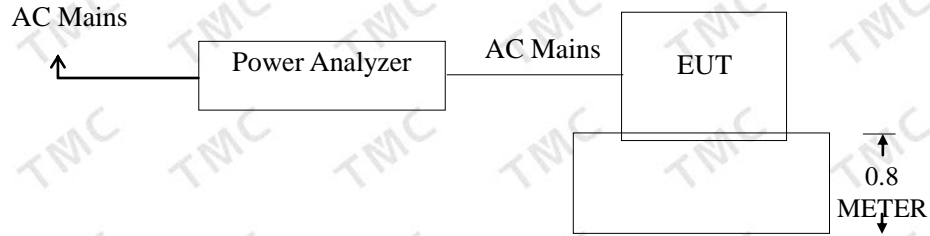

(EUT: LED LINEAR LIGHT - TRUNKING)

8.2. Test Standard

EN61000-3-2:2014

8.3. Operating Condition of EUT

- 8.3.1. Setup the EUT as shown in Section 5.1.
- 8.3.2. Turn on the power of all equipments.
- 8.3.3. Let the EUT work in test mode (ON) and test it.

8.4. Test Procedure

The power cord of the EUT is connected to the output of the test system. Turn on the Power of the EUT and use the test system to test the harmonic current level.

8.5. Test Results

Pass

9. VOLTAGE FLUCTUATIONS & FLICKER TEST

9.1. Block Diagram of Test Setup

Same as Section 7.1..

9.2. Test Standard

EN 61000-3-3:2013

9.3. Operating Condition of EUT

Same as Section 7.3.. The power cord of the EUT is connected to the output of the test system. Turn on the power of the EUT and use the test system to test the harmonic current level.

Flicker Test Limit

Test items	Limits
Pst	1.0
dc	3.3%
dmax	4.0%
dt	Not exceed 3.3% for 500ms

9.4. Test Data

Flicker test Data

Model No.:VT-4549D		
Test Mode: 1		
Items	Reading	Limit
dmax	0.00	4.0%
dc	0.00	3.3%
dt	0.00	Not exceed 3.3% for 500ms
Pst	0.001	1.0

9.5. Test Results

PASS.

10. ELECTROSTATIC DISCHARGE TEST

10.1. Block Diagram of ESD Test Setup

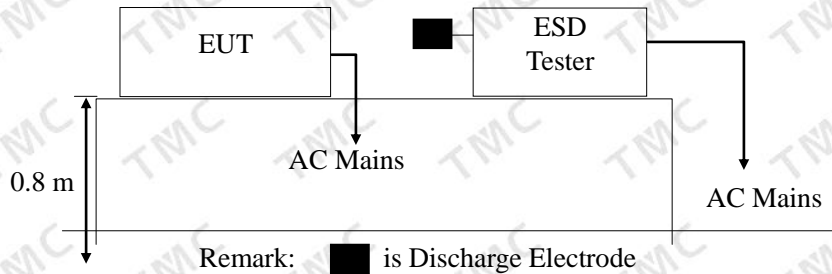

10.2. Test Standard

EN 61547:2009 (EN61000-4-2:2009)
Severity Level 3 for Air Discharge at 8KV
Severity Level 2 for Contact Discharge at 4KV

10.3. Severity Levels and Performance Criterion

10.3.1. Severity level

Level	Test Voltage Contact Discharge (KV)	Test Voltage Air Discharge (KV)
1.	2	2
2.	4	4
3.	6	8
4.	8	15
X.	Special	Special

10.3.2. Performance criterion: B

10.4. EUT Configuration on Test

The configuration of EUT are listed in Section 3.2.

10.5. Operating Condition of EUT

- 10.5.1. Setup the EUT as shown in Section 9.1.
- 10.5.2. Turn on the power of all equipments.
- 10.5.3. Let the EUT work in test mode (full load) and test it.

10.6. Test Procedure

10.6.1. Air Discharge:

This test is done on a non-conductive surfaces. The round discharge tip of the discharge electrode shall be approached as fast as possible to touch the EUT.

After each discharge, the discharge electrode shall be removed from the EUT.

The generator is then re-triggered for a new single discharge and repeated 10 Jasesones for each pre-selected test point. This procedure shall be repeated until all the air discharge completed.

10.6.2. Contact Discharge:

All the procedure shall be same as Section 9.6.1. except that the tip of the discharge electrode shall touch the EUT before the discharge switch is operated.

10.6.3. Indirect discharge for horizontal coupling plane

At least 20 single discharges shall be applied to the horizontal coupling plane, at points on each side of the EUT. The discharge electrode positions vertically at a distance of 0.1m from the EUT and with the discharge electrode touching the coupling plane.

10.6.4. Indirect discharge for vertical coupling plane

At least 20 single discharge shall be applied to the center of one vertical edge of the coupling plane. The coupling plane, of dimensions 0.5m X 0.5m, is placed parallel to, and positioned at a distance of 0.1m from the EUT. Discharges shall be applied to the coupling plane, with this plane in sufficient different positions that the four faces of the EUT are completely illuminated.

10.7. Test Results

PASS.

Please refer to the following page.

Electrostatic Discharge Test Results

TMC Testing Services (Shenzhen) Co., Ltd.

<i>Applicant</i> : V-TAC EXPORTS LIMITED	<i>Test Date</i> : July 19, 2017	
<i>EUT</i> : LED LINEAR LIGHT - TRUNKING	<i>Temperature</i> : 22 °C	
<i>M/N</i> : VT-4549D	<i>Humidity</i> : 50%	
<i>Power Supply</i> : AC230V,50Hz	<i>Test Mode</i> : Lighting	
<i>Test Engineer</i> : Jason		
<i>Air Discharge:</i> ±8KV <i>For each point positive 10 Jasesones and negative 10 Jasesones discharge.</i>		
<i>Contact Discharge:</i> ±4KV		
<i>Location</i>	<i>Kind</i> A-Air Discharge C-Contact Discharge	<i>Result</i>
<i>LED</i> <i>10 points</i>	A	PASS
<i>Slots</i> <i>10 points</i>	A	PASS
<i>Metal Part</i> <i>10 points</i>	C	PASS
<i>HCP</i> <i>10 points</i>	C	PASS
<i>VCP of Front</i> <i>10 points</i>	C	PASS
<i>VCP of Rear</i> <i>10 points</i>	C	PASS
<i>VCP of Left</i> <i>10 points</i>	C	PASS
<i>VCP of Right</i> <i>10 points</i>	C	PASS

Discharge should be considered on Contact and Air and Horizontal Coupling Plane (HCP) and Vertical Coupling Plane (VCP).

11. RF FIELD STRENGTH SUSCEPTIBILITY TEST

11.1. R/S Test Setup

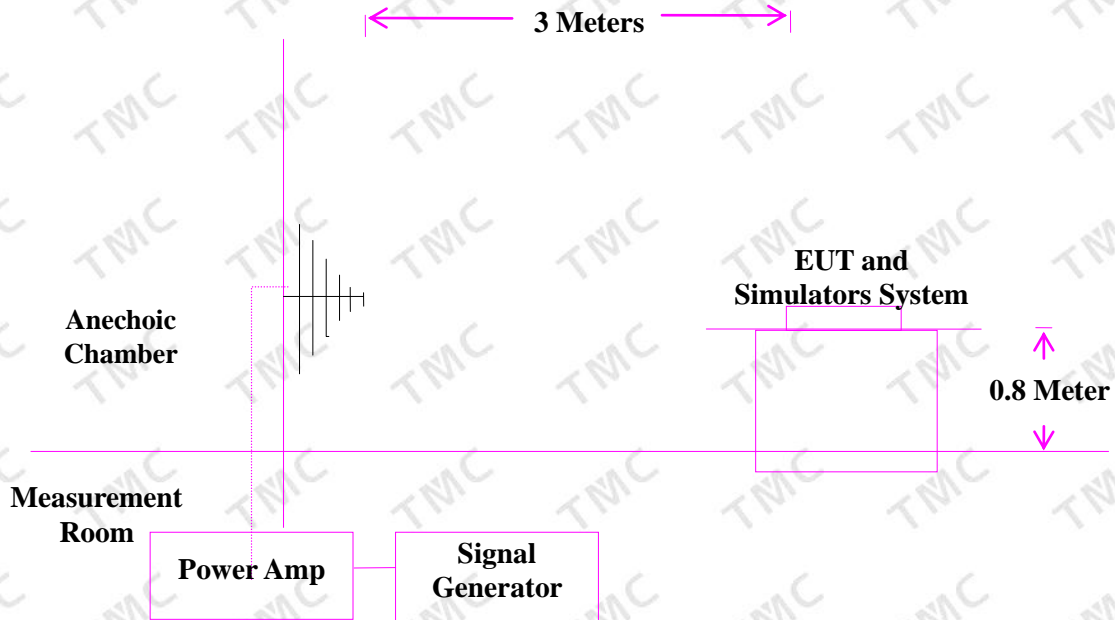

11.2. Test Standard

EN 61547:2009 (EN61000-4-3:2006+A1:2008+A2:2010)
Severity Level 2 at 3V / m

11.3. Severity Levels and Performance Criterion

11.3.1. Severity level

Level	Field Strength V/m
1.	1
2.	3
3.	10
X.	Special

11.3.2. Performance criterion : A

11.4. EUT Configuration on Test

The configuration of EUT are listed in Section 3.2.

11.5. Operating Condition of EUT

Setup the EUT as shown in Section 10.1.. The operating condition of EUT are listed in section 3.3.

11.6. Test Procedure

The EUT and its simulators are placed on a turn table which is 0.8 meter above the ground. The EUT is set 3 meters away from the transmitting antenna which is mounted on an antenna tower. Both horizontal and vertical polarization of the antenna are set on test. Each of the four sides of EUT must be faced this transmitting antenna and measured individually.

In order to judge the EUT performance, a CCD camera is used to monitor the EUT.

All the scanning conditions are as follows :

Condition of Test	Remarks
Fielded Strength	3 V/m (Severity Level 2)
Radiated Signal	Modulated
Scanning Frequency	80 - 1000 MHz
Sweeping Jassone of radiated	0.0015 decade/s
Dwell Jassone	1 Sec.

11.7. Test Results

PASS.

Please refer to the following page.

RF Field Strength Susceptibility Test Results

TMC Testing Services (Shenzhen) Co., Ltd.

<i>Applicant</i> : V-TAC EXPORTS LIMITED	<i>Test Date</i> : July 19, 2017	
<i>EUT</i> : LED LINEAR LIGHT - TRUNKING	<i>Temperature</i> : 22 °C	
<i>M/N</i> : VT-4549D	<i>Humidity</i> : 50 %	
<i>Power Supply</i> : AC230V,50Hz	<i>Test Mode</i> : Lighting	
<i>Test Engineer</i> : George	<i>Frequency Range</i> : 80 MHz to 1000 MHz	
<i>Modulation:</i> <input checked="" type="checkbox"/> AM <input type="checkbox"/> Pulse <input type="checkbox"/> none 1 KHz 80%		
<i>Criterion</i> : A		
<i>Frequency Rang</i> : 80-1000		
<i>Steps</i>	<i>1%</i>	<i>1%</i>
	<i>Horizontal</i>	<i>Vertical</i>
<i>Front</i>	<i>Pass</i>	<i>Pass</i>
<i>Right</i>	<i>Pass</i>	<i>Pass</i>
<i>Rear</i>	<i>Pass</i>	<i>Pass</i>
<i>Left</i>	<i>Pass</i>	<i>Pass</i>

12. ELECTRICAL FAST TRANSIENT/BURST TEST

12.1. EFT Test Setup

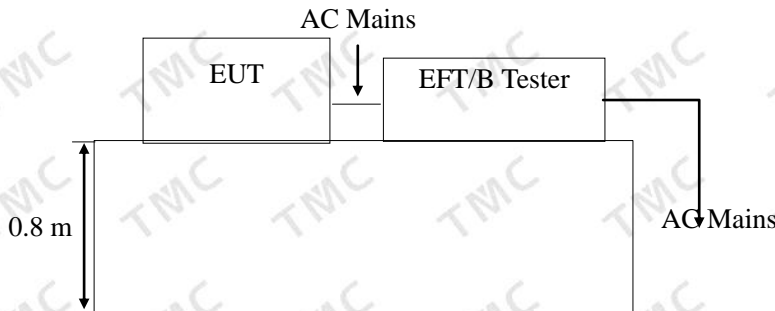

12.2. Test Standard

EN 61547:2009 (EN61000-4-4:2012)
Severity Level 2 at 1KV

12.3. Severity Levels and Performance Criterion

12.3.1. Severity level

Open Circuit Output Test Voltage $\pm 10\%$		
Level	On Power Supply Lines	On I/O (Input/Output) Signal data and control lines
1.	0.5 KV	0.25 KV
2.	1 KV	0.5 KV
3.	2 KV	1 KV
4.	4 KV	2 KV
X	Special	Special

12.3.2. Performance criterion : B

12.4. EUT Configuration on Test

The configuration of EUT are listed in Section 3.2..

12.5. Operating Condition of EUT

Setup the EUT as shown in Section 11.1.. The operating condition of EUT are listed in section 3.3.

12.6. Test Procedure

The EUT is put on the table which is 0.8 meter high above the ground. This reference ground plane shall project beyond the EUT by at least 0.1m on all sides and the minimum distance between the EUT and all other conductive structure, except the ground plane beneath the EUT, shall be more than 0.5m.

12.6.1. For input and output AC power ports:

The EUT is connected to the power mains by using a coupling device which couples the EFT interference signal to AC power lines. Both polarities of the test voltage should be applied during compliance test and the duration of the test is 2 mins.

12.6.2. For signal lines and control lines ports:

It's necessary to test.

12.6.3. For DC output line ports:

It's unnecessary to test.

12.7. Test Results

PASS.

Please refer to the following page.

Electrical Fast Transient/Burst Test Results

TMC Testing Services (Shenzhen) Co., Ltd.

<i>Applicant</i> : V-TAC EXPORTS LIMITED		<i>Test Date</i> : July 19, 2017							
<i>EUT</i> : LED LINEAR LIGHT - TRUNKING		<i>Temperature</i> : 22 °C							
<i>M/N</i> : VT-4549D		<i>Humidity</i> : 50 %							
<i>Power Supply</i> : AC230V,50Hz		<i>Test Mode</i> : Lighting							
<i>Test Engineer</i> : Kelly									
<i>Inject Place</i> : AC Mains									
<i>Inject Line</i>	<i>Voltage KV</i>	<i>Inject Jaseone(s)</i>	<i>Inject Method</i>	<i>Results</i>	<i>Inject Line</i>	<i>Voltage KV</i>	<i>Inject Jaseone(s)</i>	<i>Inject Method</i>	<i>Results</i>
L	±1	120	Direct	PASS					
N	±1	120	Direct	PASS					
L N	±1	120	Direct	PASS					

13. SURGE TEST

13.1. Surge Test Setup

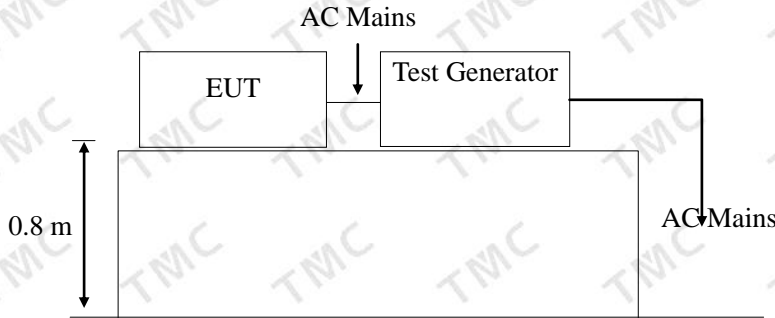

13.2. Test Standard

EN 61547:2009 (EN61000-4-5:2006)
Severity Level 2 for Line to Neutral at 1.0KV

13.3. Severity Levels and Performance Criterion

13.3.1. Severity level

Severity Level	Open-Circuit Test Voltage KV
1	6.5
2	7.0
3	8.0
4	4.0
*	Special

Performance criterion : C

13.4. EUT Configuration on Test

The configuration of EUT are listed in Section 3.2.

13.5. Operating Condition of EUT

- 13.5.1. Setup the EUT as shown in Section 12.1..
- 13.5.2. Turn on the power of all equipments.
- 13.5.3. Let the EUT work in test mode (Full load) and test it.

13.6. Test Procedure

- 1) Set up the EUT and test generator as shown on Section 12.1

- 2) For line to line coupling mode, provide a 0.5KV 1.2/50us voltage surge (at open-circuit condition) and 8/20us current surge to EUT selected points.
- 3) At least 5 positive and 5 negative (polarity) tests with a maximum 1/min repetition rate are conducted during test.
- 4) Different phase angles are done individually.
- 5) Record the EUT operating situation during compliance test and decide the EUT immunity criterion for above each test.

13.7. Test Results

PASS.

Please refer to the following page.

Surge Immunity Test Results

TMC Testing Services (Shenzhen) Co., Ltd.

<i>Applicant</i> : V-TAC EXPORTS LIMITED				<i>Test Date</i> : July 19, 2017	
<i>EUT</i> : LED LINEAR LIGHT - TRUNKING				<i>Temperature</i> : 22 °C	
<i>M/N</i> : VT-4549D				<i>Humidity</i> : 50 %	
<i>Power Supply</i> : AC230V,50Hz				<i>Test Mode</i> : Lighting	
<i>Test Engineer</i> : Kelly					
<i>Location</i>	<i>Polarity</i>	<i>Phase Angle</i>	<i>No of Pulse</i>	<i>Pulse Voltage (KV)</i>	<i>Result</i>
L-N	+	0	5	1.0	PASS
	+	90	5	1.0	PASS
	+	180	5	1.0	PASS
	+	270	5	1.0	PASS
	-	0	5	1.0	PASS
	-	90	5	1.0	PASS
	-	180	5	1.0	PASS
	-	270	5	1.0	PASS

14. INJECTED CURRENTS SUSCEPTIBILITY TEST

14.1. Block Diagram of Test AC Mains Setup

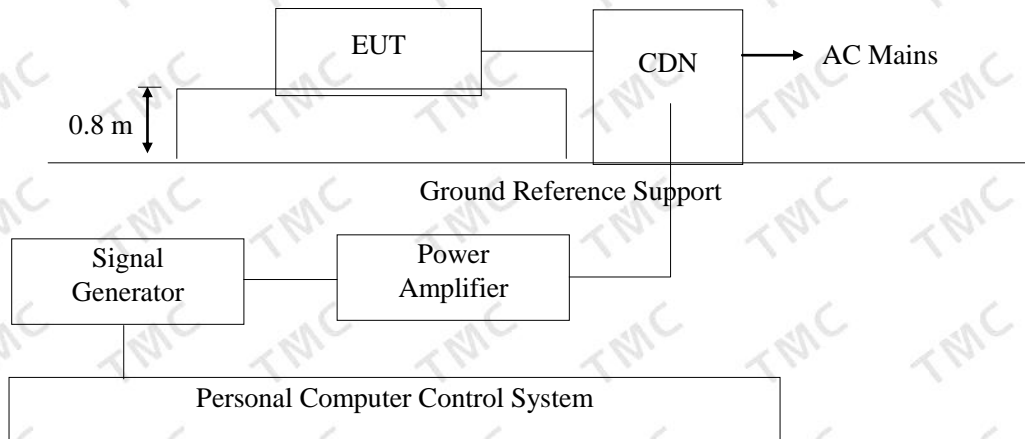

14.2. Test Standard

EN 61547:2009 (EN61000-4-6:2014)
Severity Level 2 at 3 V (rms), 0.15MHz ~ 80MHz

14.3. Severity Levels and Performance Criterion

14.3.1. Severity level

Level	Field Strength V/m
1.	1
2.	3
3.	10
X	Special

14.3.2. Performance criterion: A

14.4. EUT Configuration on Test

The configuration of EUT are listed in Section 3.2.

14.5. Operating Condition of EUT

Setup the EUT as shown in Section 13.1.. The operating condition of EUT are listed in section 3.3.

14.6. Test Procedure

- 1) Set up the EUT, CDN and test generators as shown on Section 13.1.

- 2) Let the EUT work in test mode and test it.
- 3) The EUT are placed on an insulating support 0.8m high above a ground reference plane. CDN (coupling and decoupling device) is placed on the ground plane about 0.3m from EUT. Cables between CDN and EUT are as short as possible, and their height above the ground reference plane shall be between 30 and 50 mm (where possible).
- 4) The disturbance signal described below is injected to EUT through CDN.
- 5) The EUT operates within its operational mode(s) under intended climatic conditions after power on.
- 6) The frequency range is swept from 150KHz to 80MHz using 3V signal level, and with the disturbance signal 80% amplitude modulated with a 1KHz sine wave.
- 7) The rate of sweep shall not exceed 1.5×10^{-3} decades/s. Where the frequency is swept incrementally, the step size shall not exceed 1% of the start and thereafter 1% of the preceding frequency value.
- 8) Recording the EUT operating situation during compliance testing and decide the EUT immunity criterion.

14.7. Test Results

PASS.

Please refer to the following page.

Injected Currents Susceptibility Test Results

TMC Testing Services (Shenzhen) Co., Ltd.

<i>Applicant</i> : V-TAC EXPORTS LIMITED		<i>Test Date</i> : July 19, 2017		
<i>EUT</i> : LED LINEAR LIGHT - TRUNKING		<i>Temperature</i> : 22 °C		
<i>M/N</i> : VT-4549D		<i>Humidity</i> : 50 %		
<i>Power Supply</i> : AC230V,50Hz		<i>Test Mode</i> : Lighting		
<i>Test Engineer</i> : Kelly				
Frequency Range (MHz)	Injected Position	Strength	Criterion	Result
0.15 ~ 20	AC Line	3V(rms), Unmodulated	A	PASS
20 ~ 80	AC Line	3V(rms), Unmodulated	A	PASS
<i>Remark</i> : 1. Modulation Signal:1KHz 80% AM 2. Standard Applied : EN61000-4-6:1996		<i>Note</i> :		

15. MAGNETIC FIELD IMMUNITY TEST

15.1. Block Diagram of Test Setup

15.1.1. Block Diagram of the EUT

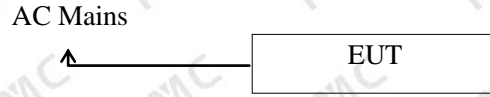

(EUT: LED LINEAR LIGHT - TRUNKING)

15.1.2. Block Diagram of Test Setup

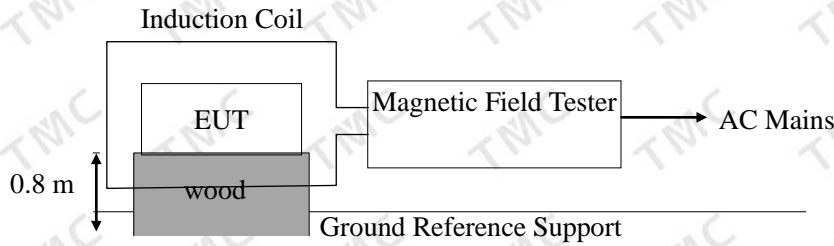

15.2. Test Standard

EN61547: 2009 (EN61000-4-8: 2010)

Severity Level 2 at 3A/m

15.3. Severity Levels and Performance Criterion

15.3.1. Severity level

Level	Magnetic Field Strength A/m
1.	1
1.	3
2.	10
3.	30
4.	100
X.	Special

15.3.2. Performance criterion: A

15.4. EUT Configuration on Test

The configuration of EUT are listed in Section 3.2.

15.5. Operating Condition of EUT

- 15.5.1. Setup the EUT as shown in Section 14.1
- 15.5.2. Turn on the power of all equipments.
- 15.5.3. Let the EUT work in test mode (ON) and test it.

15.6. Test Procedure

The EUT shall be subjected to the test magnetic field by using the induction coil of standard dimensions (1m*1m) and shown in Section 14.1. The induction coil shall then be rotated by 90° in order to expose the EUT to the test field with different orientations.

15.7. Test Results

PASS.

Please refer to the following page.

Magnetic Field Immunity Test Results

TMC Testing Services (Shenzhen) Co., Ltd.

<i>Applicant: V-TAC EXPORTS LIMITED</i>		<i>Test Date : July 19, 2017</i>		
<i>EUT : LED LINEAR LIGHT - TRUNKING</i>		<i>Temperature : 26 °C</i>		
<i>M/N : VT-4549D</i>		<i>Humidity : 60 %</i>		
<i>Power Supply : AC230V,50Hz</i>		<i>Test Engineer : Kelly</i>		
<i>Test Model: Lighting</i>				
<i>Test Level</i>	<i>Testing Duration</i>	<i>Coil Orientation</i>	<i>Criterion</i>	<i>Result</i>
<i>3A/M</i>	<i>5 mins</i>	<i>Horizontal</i>	<i>A</i>	<i>PASS</i>
<i>3A/M</i>	<i>5 mins</i>	<i>Vertical</i>	<i>A</i>	<i>PASS</i>
<i>Remark:</i>		<i>Test Equipment : Magnetic Field Tester MAG100</i>		

16. VOLTAGE DIPS AND INTERRUPTIONS TEST

16.1. Voltage Dips and Interruptions Test Setup

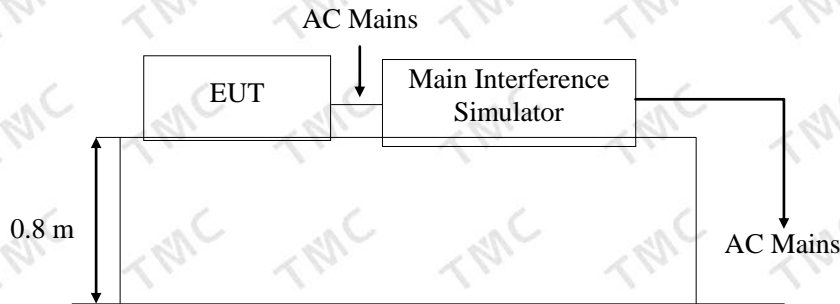

Remark: Combination wave generator and decoupling network are included in test generator.

16.2. Test Standard

EN 61547:2009 (EN61000-4-11:2004)

16.3. Severity Levels and Performance Criterion

16.3.1. Severity level

Test Level %U _T	Voltage dip and short interruptions %U _T	Duration (in period)
0	100	250p
40	60	5p
70	30	0.5p

16.3.2. Performance criterion : C & B

16.4. EUT Configuration on Test

The configuration of EUT are listed in Section 3.2.

16.5. Operating Condition of EUT

16.5.1. Setup the EUT as shown in Section 15.1..

16.5.2. Turn on the power of all equipments.

16.5.3. Let the EUT work in test mode (SPEAKERS Playing) and test it.

16.6. Test Procedure

- 1) Set up the EUT and test generator as shown on Section 15.1.
- 2) The interruptions is introduced at selected phase angles with specified duration.
- 3) Record any degradation of performance.

16.7. Test Result

PASS.

Please refer to the following page.

Voltage Dips And Interruptions Test Results

TMC Testing Services (Shenzhen) Co., Ltd.

Applicant: <i>V-TAC EXPORTS LIMITED</i>			Test Date : <i>July 19, 2017</i>		
EUT : <i>LED LINEAR LIGHT - TRUNKING</i>			Temperature : <i>26 °C</i>		
M/N : <i>VT-4549D</i>			Humidity : <i>64 %</i>		
Power Supply : <i>AC230V,50Hz</i>			Test Engineer : <i>Kelly</i>		
Test Model: <u><i>Lighting</i></u>					
Test Level <i>% U_T</i>	Voltage Dips & Short Interruptions <i>% U_T</i>	Duration (in period)	Phase Angle	Criterion	Result
<i>70</i>	<i>30</i>	<i>10P</i>	<i>90°</i>	<i>C</i>	<i>PASS</i>
<i>0</i>	<i>100</i>	<i>0.5P</i>	<i>180°</i>	<i>B</i>	<i>PASS</i>
Remark: <i>U_T is the rated voltage for the equipment.</i>			Test Equipment : <i>Main Interference Simulator (HEAFELY PLINE1610)</i>		

APPENDIX I

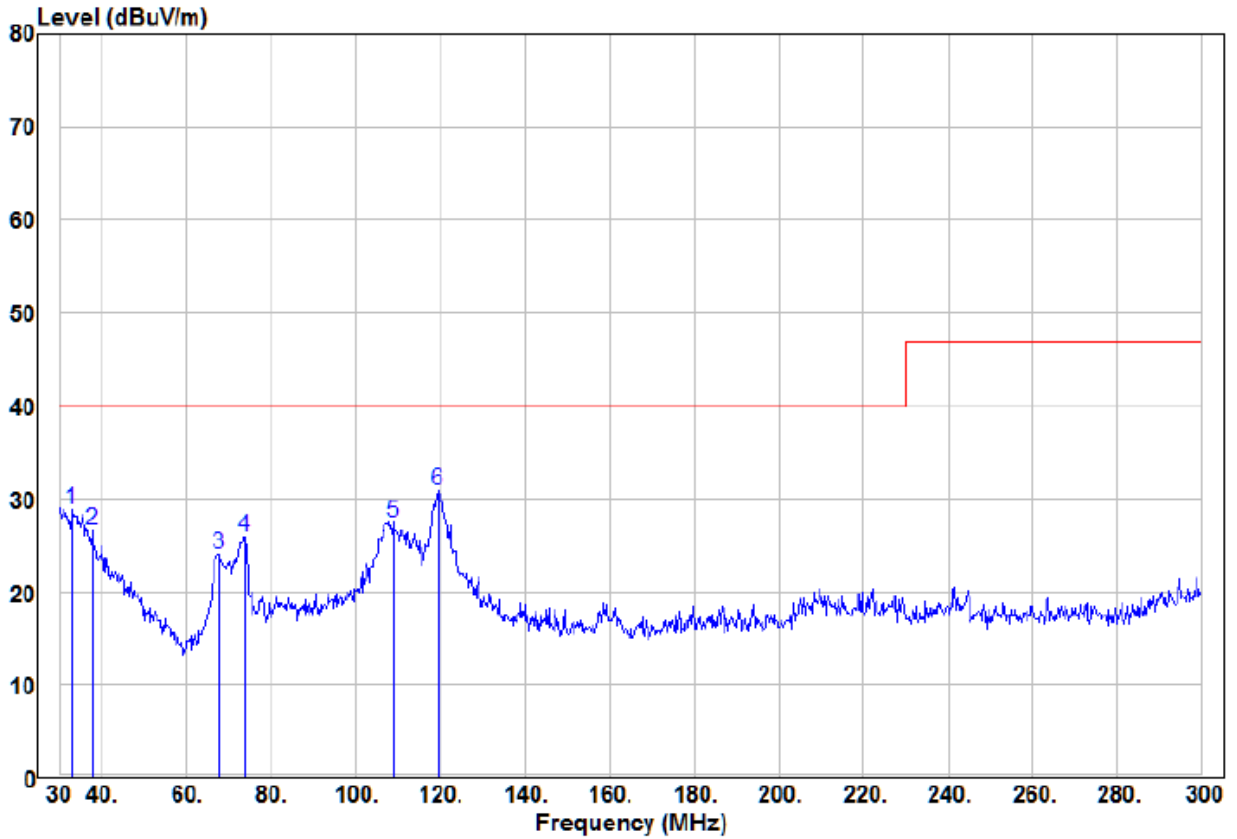

Site : chamber
 Condition: 3m HL562 BELOW 1GHZ VERTICAL
 Setup : LED LINEAR LIGHT - TRUNKING
 Mode :
 Memo :

	Read Freq	Level	Factor	Level	Limit	Over	Remark	Pol/Phase
	MHZ	dBuV	dB/m	dBuV/m	dBuV/m	dB		
1	32.97	10.18	18.67	28.85	40.00	-11.15	Peak	VERTICAL
2	37.56	9.95	16.71	26.66	40.00	-13.34	Peak	VERTICAL
3	67.53	16.80	7.33	24.13	40.00	-15.87	Peak	VERTICAL
4	73.74	17.23	8.74	25.97	40.00	-14.03	Peak	VERTICAL
5	108.84	17.25	10.30	27.55	40.00	-12.45	Peak	VERTICAL
6 pp	119.37	20.20	10.67	30.87	40.00	-9.13	Peak	VERTICAL

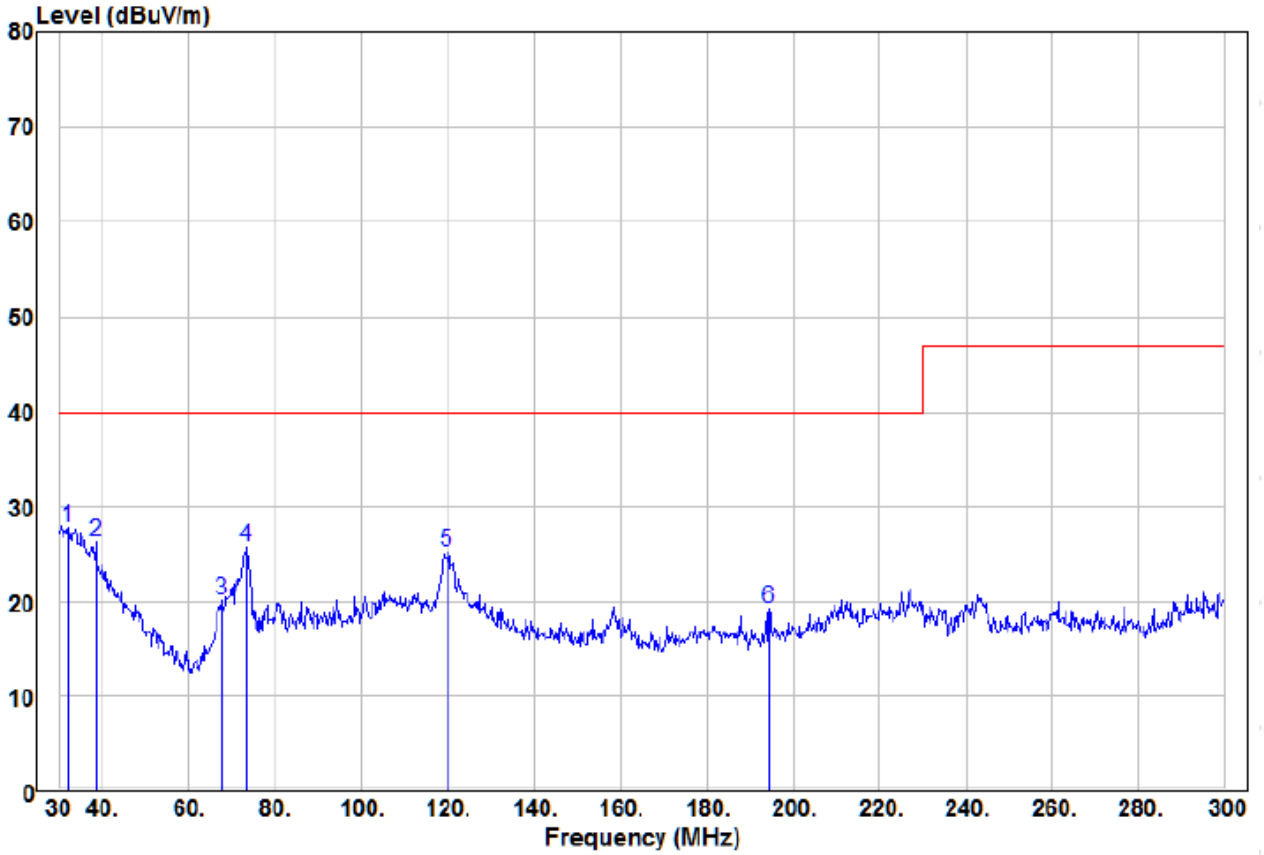

✓ site : chamber
 Condition: 3m HL562 BELOW 1GHZ HORIZONTAL
 eut : LED LINEAR LIGHT - TRUNKING
 mode :
 memo :

	Read Freq	Read Level	Factor	Level	Limit Line	Over Limit	Remark	Pol/Phase	
	MHz	dBuV	dB/m	dBuV/m	dBuV/m	dB			
1	pp	32.16	9.10	18.74	27.84	40.00	-12.16	Peak	HORIZONTAL
2		38.37	10.18	16.14	26.32	40.00	-13.68	Peak	HORIZONTAL
3		67.53	12.88	7.33	20.21	40.00	-19.79	Peak	HORIZONTAL
4		73.20	17.21	8.64	25.85	40.00	-14.15	Peak	HORIZONTAL
5		119.91	14.54	10.70	25.24	40.00	-14.76	Peak	HORIZONTAL
6		194.43	11.07	8.16	19.23	40.00	-20.77	Peak	HORIZONTAL

APPENDIX II

Conducted Emission Measurement

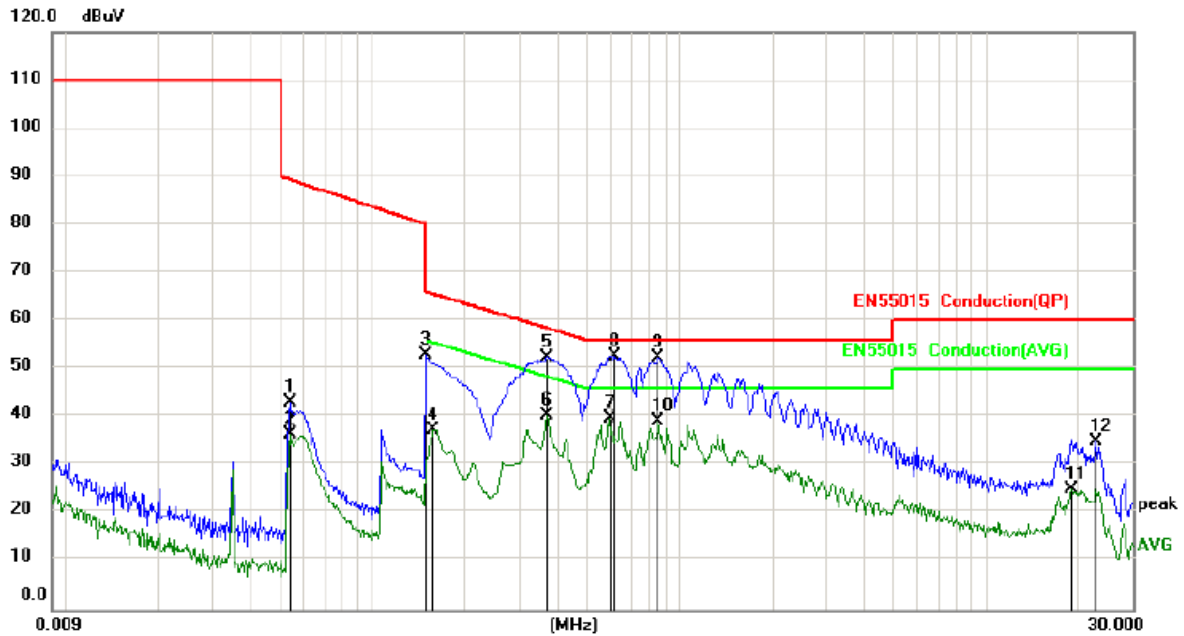

Site: Phase: **L1** Temperature: 25
 Limit: EN55015 Conduction(QP) Power: AC 230V/50Hz Humidity: 54 %
 EUT: LED LINEAR LIGHT - TRUNKING
 M/N: VT-4549D
 Mode:
 Note:

No.	Mk.	Freq. MHz	Reading Level dBuV	Correct Factor dB	Measure- ment dBuV	Limit dBuV	Over dB	Detector	Comment
1		0.0539	33.24	9.73	42.97	89.32	-46.35	peak	
2		0.0539	26.68	9.73	36.41	64.50	-28.09	AVG	
3		0.1500	43.12	9.73	52.85	66.00	-13.15	peak	
4		0.1580	27.58	9.73	37.31	55.57	-18.26	AVG	
5		0.3700	42.76	9.74	52.50	58.50	-6.00	peak	
6		0.3700	30.59	9.74	40.33	48.50	-8.17	AVG	
7		0.5901	29.95	9.74	39.69	46.00	-6.31	AVG	
8	*	0.6181	42.95	9.74	52.69	56.00	-3.31	peak	
9		0.8581	42.71	9.75	52.46	56.00	-3.54	peak	
10		0.8581	29.41	9.75	39.16	46.00	-6.84	AVG	
11		18.9980	15.32	9.88	25.20	50.00	-24.80	AVG	
12		22.9341	25.01	9.87	34.88	60.00	-25.12	peak	

Conducted Emission Measurement

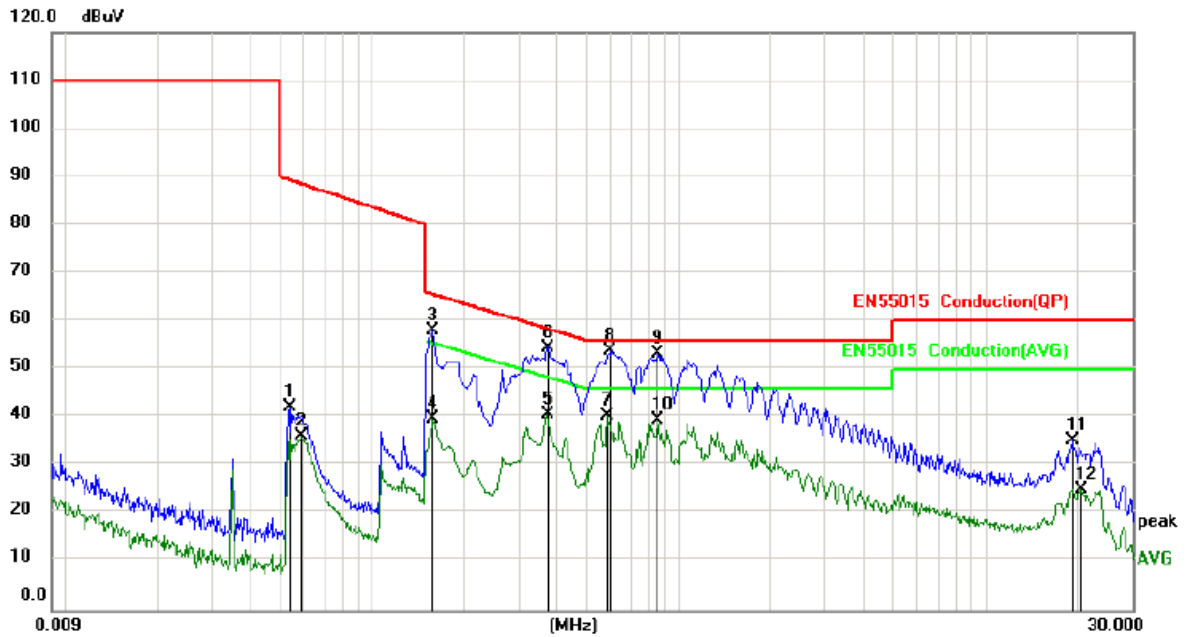

Site: Phase: **N** Temperature: 25
 Limit: EN55015 Conduction(QP) Power: AC 230V/50Hz Humidity: 54 %
 EUT: LED LINEAR LIGHT - TRUNKING
 M/N: VT-4549D
 Mode:
 Note:

No.	Mk.	Freq. MHz	Reading Level dBuV	Correct Factor dB	Measure- ment dBuV	Limit dBuV	Over dB	Detector	Comment
1		0.0537	32.46	9.76	42.22	89.35	-47.13	peak	
2		0.0587	26.28	9.77	36.05	63.79	-27.74	AVG	
3		0.1581	48.25	9.79	58.04	65.56	-7.52	peak	
4		0.1581	29.84	9.79	39.63	55.56	-15.93	AVG	
5		0.3701	30.83	9.80	40.63	48.50	-7.87	AVG	
6		0.3741	44.80	9.80	54.60	58.41	-3.81	peak	
7		0.5861	30.46	9.80	40.26	46.00	-5.74	AVG	
8	*	0.5981	43.99	9.80	53.79	56.00	-2.21	peak	
9		0.8581	43.43	9.81	53.24	56.00	-2.76	peak	
10		0.8581	29.67	9.81	39.48	46.00	-6.52	AVG	
11		19.2021	25.46	9.88	35.34	60.00	-24.66	peak	
12		20.5421	15.29	9.89	25.18	50.00	-24.82	AVG	

APPENDIX III

Photo 1 General appearance of the EUT



Photo 2 General appearance of the EUT

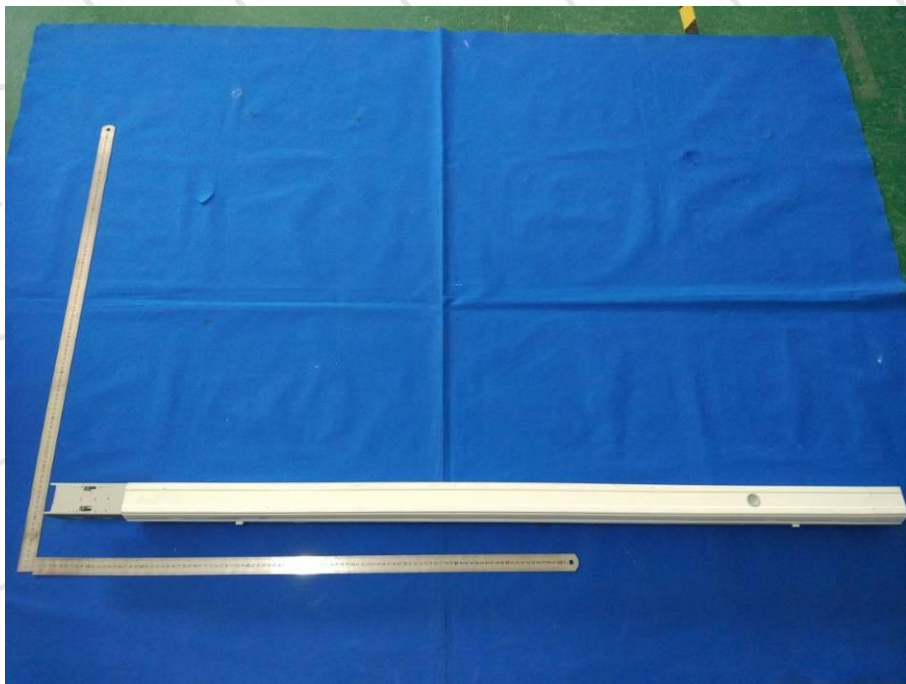

Photo 3 General appearance of the EUT

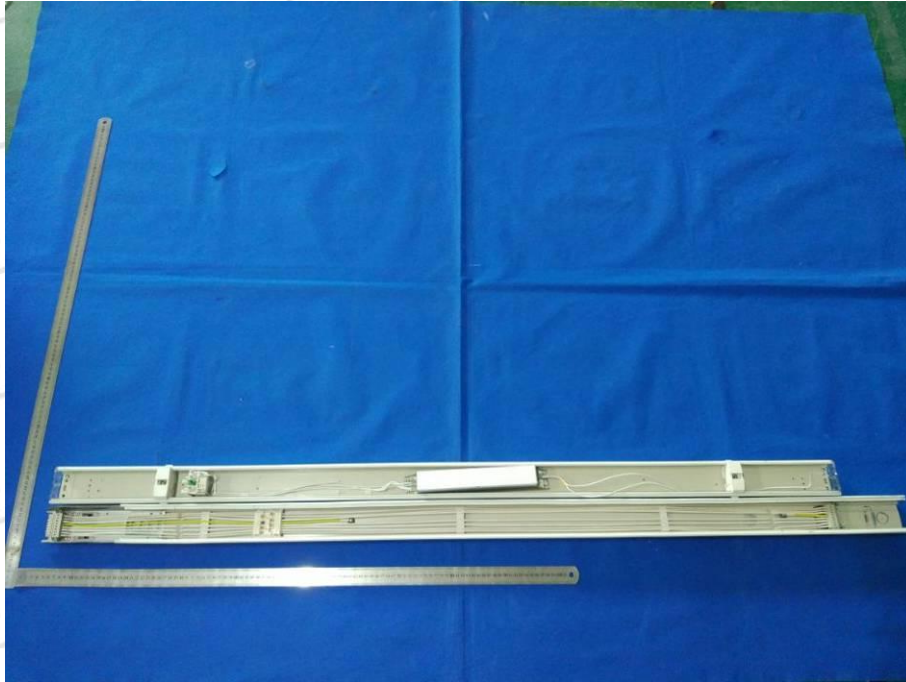

Photo 4 General appearance of the EUT

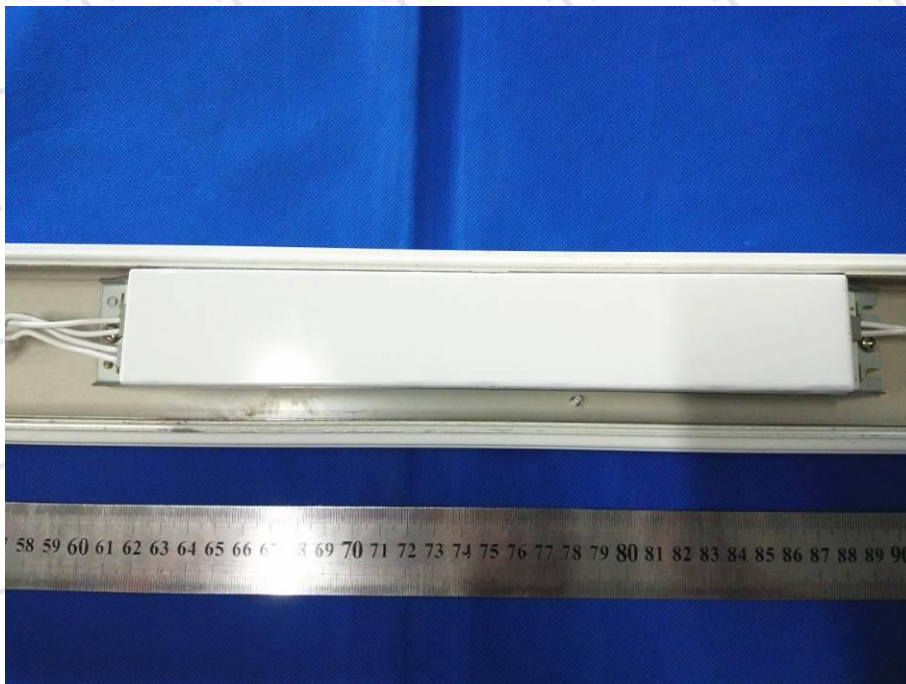

Photo 5 General appearance of the EUT

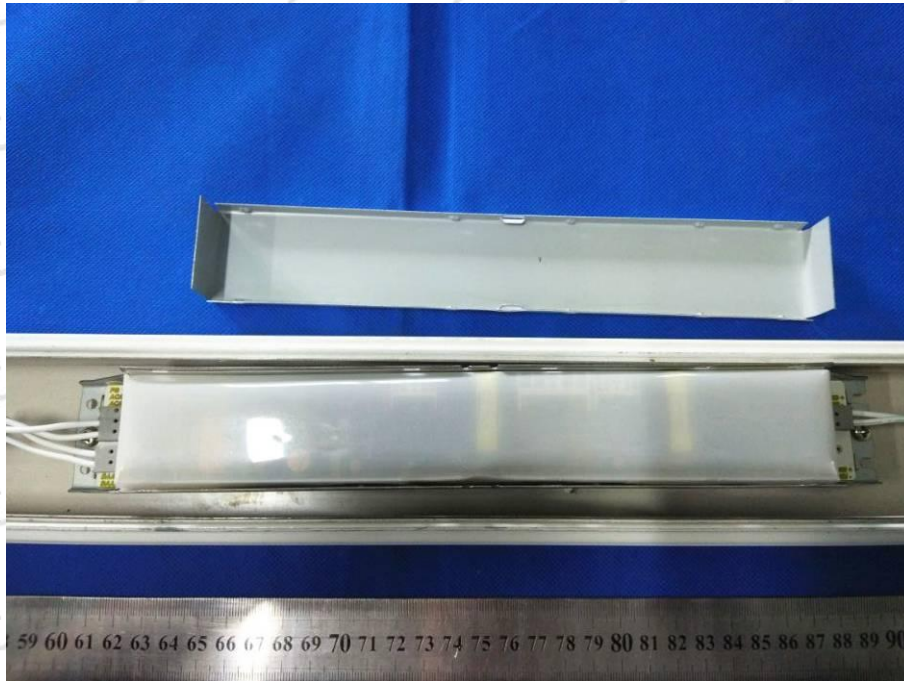

Photo 6 General appearance of the EUT

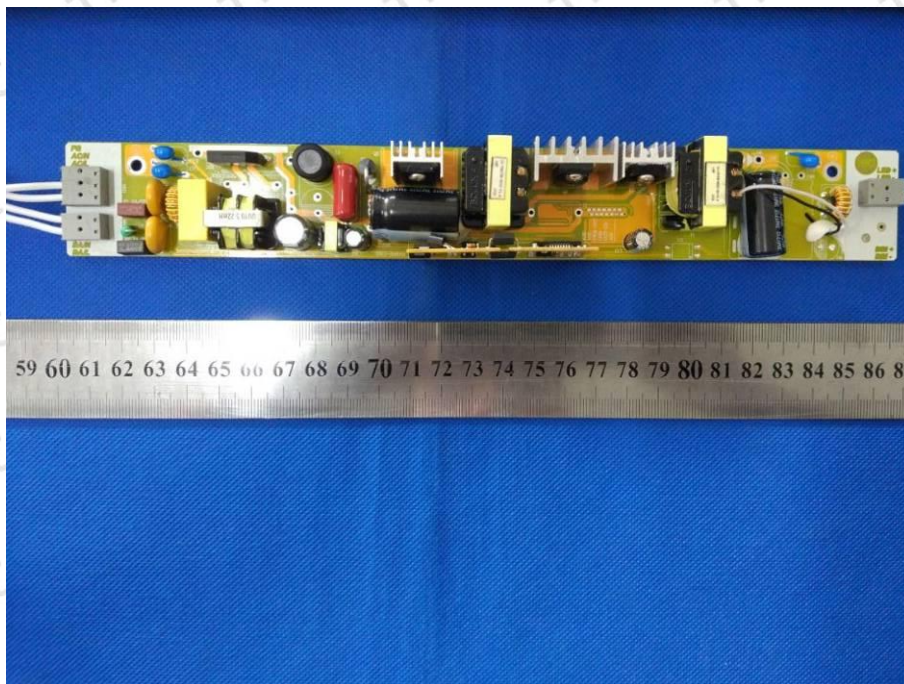

Photo 7 General appearance of the EUT

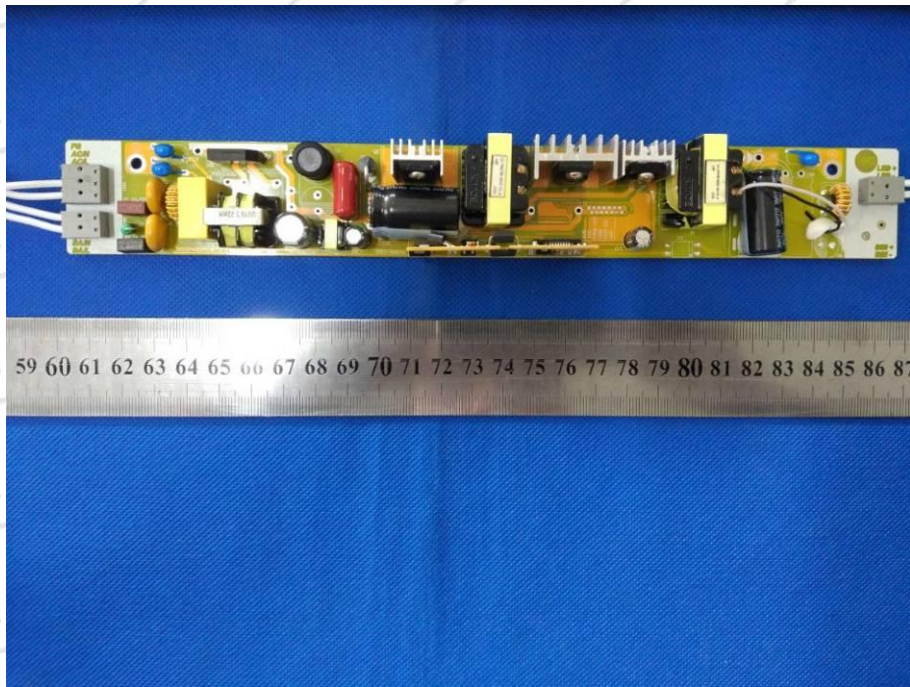

Photo 8 General appearance of the EUT

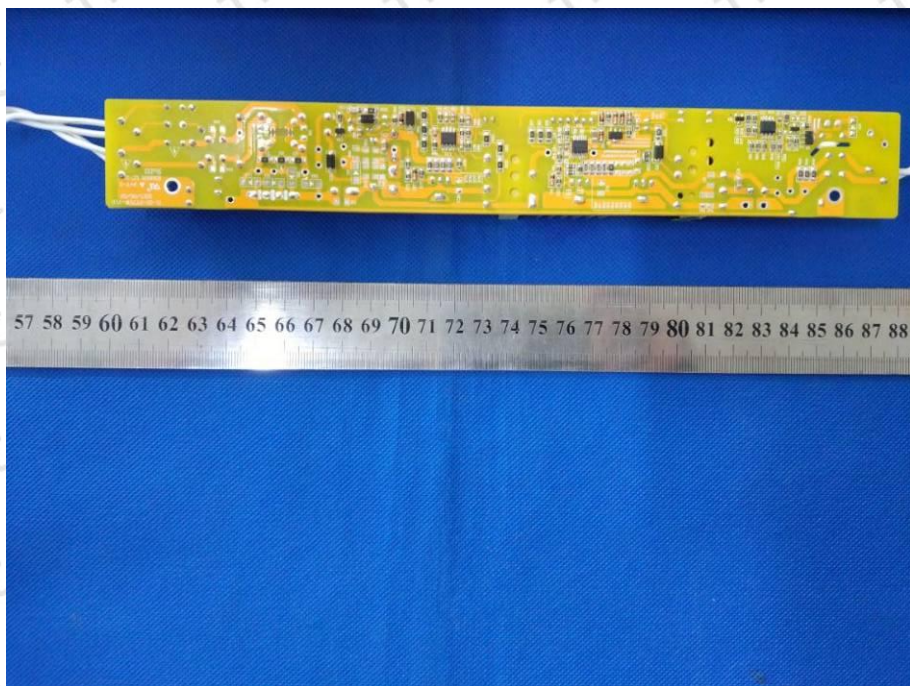

Photo 9 General appearance of the additional model

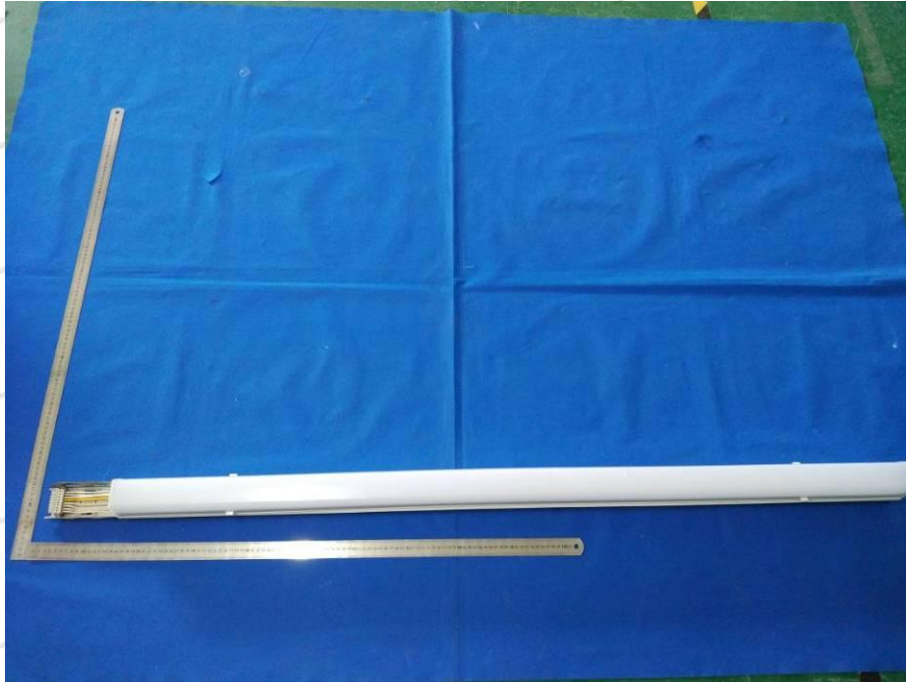

Photo10 Radiated Emission Test

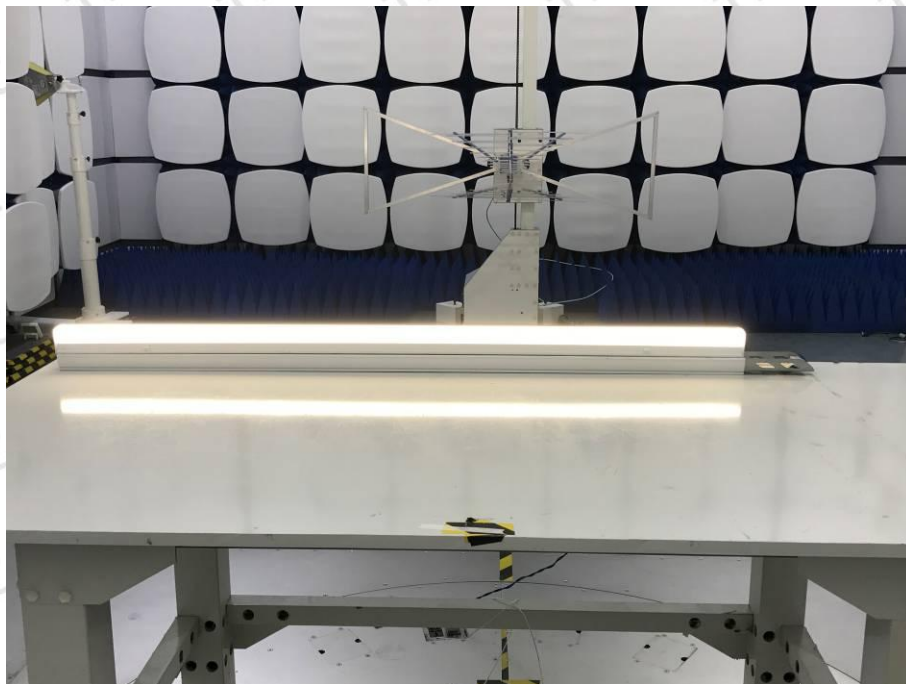

Photo 11 Conducted Emission Test



END OF REPORT