



EMC TEST REPORT

For

V-TAC EXPORTS LIMITED

LED PENDANT

Test Model: VT-101-2D

Additional Models : please refer to Model list

Prepared for : V-TAC EXPORTS LIMITED
Address : ROOM 301, KAM ON BUILDING, 176A QUEENS ROAD
CENTRAL, CENTRAL, HONGKONG

Prepared by : Shenzhen Southern LCS Compliance Testing Laboratory Ltd.
Address : 101-201, No.39 Building, Xialang Industrial Zone, Heshuikou
Community, Matian Street, Guangming District, Shenzhen, China

Tel : (+86)755-29871520
Fax : (+86)755-29871521
Web : www.LCS-cert.com
Mail : webmaster@LCS-cert.com

Date of receipt of test sample : February 07, 2023
Number of tested samples : 1
Serial number : Prototype
Date of Test : February 07, 2023 - March 15, 2023
Date of Report : August 04, 2023



**EMC TEST REPORT****EN IEC 55015:2019+A11:2020**

Emission - Electrical lighting and similar equipment

EN 61547:2009

Equipment for general lighting purposes - EMC immunity requirements

Report Reference No.....: LCSB070723023E

Date of Issue.....: August 04, 2023

Testing Laboratory Name.....: Shenzhen Southern LCS Compliance Testing Laboratory Ltd.

Address.....: 101-201, No.39 Building,Xialang Industrial Zone, Heshuikou Community, Matian Street,Guangming District, Shenzhen, China.

Testing Procedure.....: Full application of Harmonised standards
Partial application of Harmonised standards
Other standard testing method **Applicant's Name.....: V-TAC EXPORTS LIMITED**

Address.....: ROOM 301, KAM ON BUILDING, 176A QUEENS ROAD CENTRAL, CENTRAL, HONGKONG

Test Specification:Standard.....: EN IEC 55015:2019+A11:2020
EN IEC 61000-3-2:2019+A1:2021
EN 61000-3-3:2013+A1:2019+A2:2021
EN 61547:2009

Test Report Form No.....: SLCSEMC-2.3

TRF Originator.....: Shenzhen Southern LCS Compliance Testing Laboratory Ltd.

Master TRF.....: Dated 2016-08

Shenzhen Southern LCS Compliance Testing Laboratory Ltd. All rights reserved.

This publication may be reproduced in whole or in part for non-commercial purposes as long as the Shenzhen Southern LCS Compliance Testing Laboratory Ltd. is acknowledged as copyright owner and source of the material. Shenzhen Southern LCS Compliance Testing Laboratory Ltd. takes no responsibility for and will not assume liability for damages resulting from the reader's interpretation of the reproduced material due to its placement and context.

Equipment Under Test.....: LED PENDANT

Trademark.....: N/A

Test Model/Type.....: VT-101-2D

Rating.....: 230V~, 50Hz, 113W

Results: PASS**Compiled by:**

Amy Liu / Engineer

Supervised by:

Kris Mai / Technique Director

Approved by:

Dm Gu / Manager



Shenzhen Southern LCS Compliance Testing Laboratory Ltd.

101-201, No. 39 Building, Xialang Industrial Zone, Heshuikou Community, Matian Street, Guangming District, Shenzhen, China.

Tel: +(86) 0755-82591330 | E-mail: webmaster@lcs-cert.com | Web: www.lcs-cert.com.

Scan code to check authenticity.



EMC - TEST REPORT

Test Report No.....: LCSB070723023E

Applicant.....:	V-TAC EXPORTS LIMITED
Address.....:	ROOM 301, KAM ON BUILDING, 176A QUEENS ROAD CENTRAL, CENTRAL, HONGKONG
Telephone.....:	/
Fax.....:	/

Manufacturer.....:	V-TAC EXPORTS LIMITED
Address.....:	ROOM 301, KAM ON BUILDING, 176A QUEENS ROAD CENTRAL, CENTRAL, HONGKONG
Telephone.....:	/
Fax.....:	/

Factory.....:	V-TAC EXPORTS LIMITED
Address.....:	ROOM 301, KAM ON BUILDING, 176A QUEENS ROAD CENTRAL, CENTRAL, HONGKONG
Telephone.....:	/
Fax.....:	/

The applicant and manufacturer information, product name, model, trademark and other information in this report are all provided by the applicant, and this laboratory is not responsible for verifying its authenticity.

The test report merely corresponds to the test sample.
It is not permitted to copy extracts of these test result without the written permission of the test laboratory.





ENVIRONMENTAL CONDITIONS

The climatic conditions during the test are within the limits specified by the manufacturer for the operation of the EUT and the test equipment. the climatic conditions during the test were in the following Limits:

Ambient temperature	15°C - 30°C
Relative Humidity air	30% - 60%
Atmospheric pressure	86 kPa - 106 kPa

Climate values will be recorded and recorded separately if specifically required in the base standard or application product/product series standard.

POSSIBLE TEST CASE VERDICTS

Test cases does not apply to test object	N/A
Test object does meet requirement	P(Pass) / PASS
Test object does not meet requirement	F(Fail) / FAIL
Not measured	N/M

DEFINITION OF SYMBOLS USED IN THIS TEST REPORT

<input checked="" type="checkbox"/>	Indicate that the conditions, standards or equipment listed is applicable to this report / test / EUT.
<input type="checkbox"/>	Indicate that the conditions, standards or equipment listed is not applicable to this report / test / EUT.

REVISION HISTORY

Revision	Issue Date	Revision Content	Revised by
000	August 04, 2023	Initial Issue	-

Remark:

Declared by applicant, applicant and manufacturer change from

“Name: Dasher Lighting Technology Co., Ltd.”

“Address: No.9 Yongxing north RD., Henglan Town, Zhongshan City, Guangdong Province 528400, China”

to

“Name: V-TAC EXPORTS LIMITED”

“Address: ROOM 301, KAM ON BUILDING, 176A QUEENS ROAD CENTRAL, CENTRAL, HONGKONG”

See page 6~7 for model list.

Note: Original Test Report “LCSB020723019E” dated March 15, 2023. This revised test report is based on the test raw-data of original test report, after information review and verification, no additional tests were considered necessary.



Shenzhen Southern LCS Compliance Testing Laboratory Ltd.

101-201, No. 39 Building, Xialang Industrial Zone, Heshuikou Community, Matian Street, Guangming District, Shenzhen, China.

Tel: +(86) 0755-82591330 | E-mail: webmaster@lcs-cert.com | Web: www.lcs-cert.com.

Scan code to check authenticity.



TABLE OF CONTENTS

- 1. GENERAL INFORMATION 6**
 - 1.1. General Description of The Item(s) 6
 - 1.2. Operating Mode(s) Used of Tests 9
 - 1.3. Support / Auxiliary Equipment for The EUT 9
 - 1.4. Description of Test Facility 9
- 2. STATEMENT OF THE MEASUREMENT UNCERTAINTY 10**
- 3. MEASURING DEVICES AND TEST EQUIPMENT 11**
- 4. VERDICT SUMMARY SECTION 13**
 - 4.1. Standard(s) 13
 - 4.2. Overview of Results 14
- 5. EMISSION TESTS 15**
 - 5.1. Conducted Disturbance 15
 - 5.2. Radiated Disturbance (9KHz - 30MHz) 17
 - 5.3. Radiated Disturbance (30MHz - 1GHz) 18
 - 5.4. Harmonic Current 19
 - 5.5. Voltage Fluctuations & Flicker 20
- 6. IMMUNITY TESTS 21**
 - 6.1. Performance Criteria 21
 - 6.2. Electrostatic Discharge 22
 - 6.3. Radio-Frequency Electromagnetic Fields 23
 - 6.4. Electrical Fast Transient / Burst 24
 - 6.5. Injected Currents (Radio-Frequency Common Mode) 25
 - 6.6. Surge 26
 - 6.7. Voltage Dips and Short Interruptions 27
- ANNEX A - TEST RESULTS 28**
- ANNEX B - TEST PHOTOS 44**
- ANNEX C - EXTERNAL AND INTERNAL PHOTOS OF THE EUT 49**





1. GENERAL INFORMATION

1.1. GENERAL DESCRIPTION OF THE ITEM(S)

Equipment Under Test	LED PENDANT
Test Model/Type	VT-101-2D
Additional Models/Type	See Model list
Description of Model difference	See Model list
Rating	See Model list
Non-restricted ELV lamps	<input type="checkbox"/> Yes <input checked="" type="checkbox"/> No



**General product information:**

- All models of drives use the same circuit and PCB layout.
- All models have similar appearance and structure except power.
- This report after information review and verification, the model "VT-101-2D" were chosen as the representative model to perform all the tests.

Model List:

Model	Rating
VT-101-2D	230V~, 50Hz, 113W
VT-82-3D	230V~, 50Hz, 86W
VT-7925	230V~, 50Hz, 50W
VT-7914	230V~, 50Hz, 48W
VT-7769	230V~, 50Hz, 12W
VT-7768	
VT-7788	
VT-7765	
VT-7906	
VT-7917	
VT-7755	230V~, 50Hz, 48W
VT-7793	
VT-7760	
VT-7762	
VT-7758	
VT-7908	
VT-7909	
VT-7911	
VT-7916	
VT-7919	
VT-7920	
VT-7921	
VT-7923	
VT-7924	
VT-7925	
VT-7926	
VT-7757	230V~, 50Hz, 38W
VT-7915	
VT-7927	
VT-7761	
VT-7907	
VT-7792	230V~, 50Hz, 20W
VT-7769	
VT-7763	
VT-7790	230V~, 50Hz, 24W
VT-7789	
VT-7791	
VT-7782	
VT-7784	
VT-7785	
VT-7758	230V~, 50Hz, 43W
VT-7764	
VT-7756	
VT-7767	230V~, 50Hz, 14W



Shenzhen Southern LCS Compliance Testing Laboratory Ltd.

101-201, No. 39 Building, Xialang Industrial Zone, Heshuikou Community, Matian Street, Guangming District, Shenzhen, China.

Tel: +(86) 0755-82591330 | E-mail: webmaster@lcs-cert.com | Web: www.lcs-cert.com.

Scan code to check authenticity.



VT-7787 VT-7781 VT-7786 VT-7779	
VT-7766	230V~, 50Hz, 30W
VT-WXYZ VT-GB-LC VT-AEF-SQ W=0,1,2.....9,X=0,1,2.....9,Y=0,1,2.....9,Z=0,1,2.....9 G=0,1,2.....9,B=0,1,2.....9, L=0,1,2.....9, C=A,B,C.....Z,A=0,1,2.....9, E=0,1,2.....9 F=,1,2...,9,S=0,1,2,....9, Q=A,B,C,....Z. VT-WXYZ, VT-GB-LC, VT-AEF-SQ stands for pendant lamp and ceiling lamp,VT stands for company brand. WXYZ, GB,LC,AEF,SQ stands for item number.	





1.2. OPERATING MODE(S) USED OF TESTS

During the tests, the following operating mode(s) has(have) been used.

Operating Mode	Operating Mode description	Used for testing	
		Emission	Immunity
1	Lighting on mode	<input checked="" type="checkbox"/>	<input checked="" type="checkbox"/>
2	Maximum light	<input type="checkbox"/>	<input type="checkbox"/>
3	Minimum light	<input type="checkbox"/>	<input type="checkbox"/>
4	Full load	<input type="checkbox"/>	<input type="checkbox"/>

1.3. SUPPORT / AUXILIARY EQUIPMENT FOR THE EUT

EUT has been tested using the following auxiliary equipment :

Auxeq	Model/Type	Manufacturer	Supplied by
--			

1.4. DESCRIPTION OF TEST FACILITY

Test Location 1	Shenzhen Southern LCS Compliance Testing Laboratory Ltd. 101-201, No.39 Building,Xialang Industrial Zone, Heshuikou Community, Matian Street, Guangming District, Shenzhen, China. CNAS Registration Number is L10160.
Test Location 2	Shenzhen LCS Compliance Testing Laboratory Ltd. 101, 201 Building A and 301 Building C, Juji Industrial Park, Yabianxueziwei, Shajing Street, Baoan District, Shenzhen, Guangdong, China. NVLAP Accreditation Code is 600167-0. CNAS Registration Number is L4595.
Date of receipt of test item	February 07, 2023
Date(s) of performance of test	February 07, 2023 - March 15, 2023

Note: Radio-Frequency Electromagnetic Field (RS) Test Subcontract to Shenzhen LCS Compliance Testing Laboratory Ltd for Testing.





2. STATEMENT OF THE MEASUREMENT UNCERTAINTY

The data and results referenced in this document are true and accurate. the reader is cautioned that there may be errors within the calibration limits of the equipment and facilities. the measurement uncertainty was calculated for all measurements listed in this test report acc. to CISPR 16 - 4 "Specification for radio disturbance and immunity measuring apparatus and methods - Part 4: Uncertainty in EMC Measurements" and is documented in the LCS quality system acc. to DIN EN ISO/IEC 17025. Furthermore, component and process variability of devices similar to that tested may result in additional deviation. the manufacturer has the sole responsibility of continued compliance of the device.

Measurement	Uncertainty (U_{lab})	Uncertainty (U_{cisp})
Conducted disturbance (9kHz - 150kHz)	± 1.40 dB	± 4.0 dB
Conducted disturbance (150kHz - 30MHz)	± 2.80 dB	± 3.6 dB
Magnetic field disturbance (9kHz - 150kHz)	± 3.46 dB	-
Magnetic field disturbance (150kHz - 30MHz)		
Radiated disturbance (9kHz - 30MHz)	± 3.12 dB	N/A
Radiated disturbance (30MHz - 200MHz)	± 4.66 dB	± 5.2 dB
Radiated disturbance (200MHz - 1GHz)	± 4.64 dB	± 5.0 dB

Supplementary information:

The reported expanded uncertainty of measurement is stated as the standard uncertainty of measurement multiplied by the coverage factor of $k=2$, which for a normal distribution corresponds to a coverage probability of approximately 95%.





3. MEASURING DEVICES AND TEST EQUIPMENT

CONDUCTED DISTURBANCE						
Item	Test equipment	Manufacturer	Model No.	Serial No.	Cal Date	Due Date
1	EMI Test Receiver	R&S	ESCI	101142	2022-05-05	2023-05-04
2	10dB Attenuator	SCHWARZBECK	VTSD9561-F	9561-F159	2022-05-05	2023-05-04
3	Artificial Mains Network	SCHWARZBECK	NSLK8127	8127716	2022-05-05	2023-05-04
4	EMI Test Software	EZ	EZ_EMG	N/A	/	/
5	Impedance Stabilization Network	SCHWARZBECK	NTFM 8158	NTFM8158#120	2022-05-05	2023-05-04
6	Voltage Probe	SCHWARZBECK	KT 9420	9420401	2022-05-05	2023-05-04
7	No. 1 shielded Room	CHENGYU	843	/	2020-06-16	2023-06-16

RADIATED DISTURBANCE (9KHz - 30MHz)						
Item	Test equipment	Manufacturer	Model No.	Serial No.	Cal Date	Due Date
1	EMI Test Receiver	R&S	ESCI	101142	2022-05-05	2023-05-04
2	Triple-loop Antenna	EVERFINE	LLA-2	9161	2022-05-05	2023-05-04
3	EMI Test Software	EZ	EZ_EMG	N/A	/	/
4	No. 1 shielded Room	CHENGYU	843	/	2020-06-16	2023-06-16

RADIATED DISTURBANCE (above 30MHz)						
Item	Test equipment	Manufacturer	Model No.	Serial No.	Cal Date	Due Date
1	3m Semi Anechoic Chamber	SIDT FRANKONIA	SAC-3M	03CH03-HY	2021-06-15	2024-06-15
2	EMI Test Receiver	R&S	ESCI3	101010	2022-05-05	2023-05-04
3	Log-periodic Antenna	SCHWARZBECK	VULB9163	5094	2022-05-08	2025-05-07
4	Coupling Decoupling Network	SCHWARZBECK	CDNE M2	00251	2022-10-13	2023-10-12
5	Coupling Decoupling Network	SCHWARZBECK	CDNE M3	00248	2022-10-13	2023-10-12
6	EMI Test Software	EZ	EZ_EMG	N/A	/	/
7	Controller system	KGS	M4U450	/	/	/

HARMONIC CURRENT & FLICKER						
Item	Test equipment	Manufacturer	Model No.	Serial No.	Cal Date	Due Date
1	Harmonic Current and Flicker Test System	HTEC	AC2000A	/	2022-05-05	2023-05-04
2	Linear Variable Frequency Power Supply	HTEC	HHF-5010	/	2022-05-05	2023-05-04

ELECTROSTATIC DISCHARGE						
Item	Test equipment	Manufacturer	Model No.	Serial No.	Cal Date	Due Date
1	ESD Simulator	TESEQ	NSG 437	1615	2022-03-21	2023-03-21

ELECTRICAL FAST TRANSIENT / BURST						
Item	Test equipment	Manufacturer	Model No.	Serial No.	Cal Date	Due Date
1	Electrical Fast Transient Generator	HTEC	HEFT51	162201	2022-05-05	2023-05-04



Shenzhen Southern LCS Compliance Testing Laboratory Ltd.

101-201, No. 39 Building, Xialang Industrial Zone, Heshuikou Community, Matian Street, Guangming District, Shenzhen, China.

Tel: +(86) 0755-82591330 | E-mail: webmaster@lcs-cert.com | Web: www.lcs-cert.com.

Scan code to check authenticity.



2	Coupling Clamp	HTEC	H3C	163701	2022-05-05	2023-05-04
---	----------------	------	-----	--------	------------	------------

SURGE

Item	Test equipment	Manufacturer	Model No.	Serial No.	Cal Date	Due Date
1	Surge Generator	3CTEST	SG5006G	EC5581070	2022-05-05	2023-05-04
2	Coupling / decoupling Network	3CTEST	SGN-5010G	EC5591033	2022-05-05	2023-05-04

INJECTED CURRENTS (RADIO-FREQUENCY COMMON MODE)

Item	Test equipment	Manufacturer	Model No.	Serial No.	Cal Date	Due Date
1	Conducted Susceptibility Generator	HTEC	CDG6000	126A140012016	2022-05-05	2023-05-04
2	Coupling Network	HTEC	CDN-M2+M3	A22/0382/2016	2022-05-05	2023-05-04
3	Attenuator 6dB	HTEC	ATT6	HA1601	2022-05-05	2023-05-04
4	Electromagnetic clamp	LUTHI	EM101	35535	2022-05-05	2023-05-04

POWER FREQUENCY MAGNETIC FIELD

Item	Test equipment	Manufacturer	Model No.	Serial No.	Cal Date	Due Date
1	Power Frequency Mag-Field Generator System	HTEC	HPFMF100	100-2400	2022-05-05	2023-05-04

VOLTAGE DIPS AND SHORT INTERRUPTIONS

Item	Test equipment	Manufacturer	Model No.	Serial No.	Cal Date	Due Date
1	Voltage Dips and up Generator	HTEC	HPFS161P	162202	2022-05-05	2023-05-04

RADIO-FREQUENCY ELECTROMAGNETIC FIELDS

Item	Test equipment	Manufacturer	Model No.	Serial No.	Cal Date	Due Date
1	ESG Vector Signal Generator	Agilent	E4438C	MY42081396	2022-06-06	2023-06-05
2	RF POWER AMPLIFIER	OPHIR	5225R	1052	2022-06-16	2023-06-15
3	RF POWER AMPLIFIER	OPHIR	5273F	1019	2022-06-16	2023-06-15
4	Stacked Broadband Log Periodic Antenna	SCHWARZBECK	STLP 9128	9128ES-145	2022-06-19	2023-06-18
5	Stacked Mikrowellen Log.-Per Antenna	SCHWARZBECK	STLP 9149	9149-484	2022-06-19	2023-06-18
6	Electric field probe	Narda S.TS./PMM	EP601	611WX80208	2022-06-06	2023-06-05



Shenzhen Southern LCS Compliance Testing Laboratory Ltd.

101-201, No. 39 Building, Xialang Industrial Zone, Heshuikou Community, Matian Street, Guangming District, Shenzhen, China.

Tel: +(86) 0755-82591330 | E-mail: webmaster@lcs-cert.com | Web: www.lcs-cert.com.

Scan code to check authenticity.



4. VERDICT SUMMARY SECTION

This chapter present an overview of the standards and results. Refer the next chapter for details of measured test results and applied test levels.

4.1. STANDARD(S)

EN IEC 55015:2019+A11:2020 - Limits and methods of measurement of radio disturbance characteristics of electrical lighting and similar equipment.

EN 61547:2009 - Equipment for general lighting purposes — EMC immunity requirements.

EN IEC 61000-3-2:2019+A1:2021 - Electromagnetic compatibility (EMC) Part 3-2: Limits for harmonic current emissions (equipment input current ≤ 16 A per phase).

EN 61000-3-3:2013+A1:2019+A2:2021 - Electromagnetic compatibility (EMC) Part 3-3: Limits for voltage changes, voltage fluctuations and flicker in public low-voltage supply systems, for equipment with rated current ≤ 16 A per phase and not subject to conditional connection.



Shenzhen Southern LCS Compliance Testing Laboratory Ltd.

101-201, No. 39 Building, Xialang Industrial Zone, Heshuikou Community, Matian Street, Guangming District, Shenzhen, China.

Tel: +(86) 0755-82591330 | E-mail: webmaster@lcs-cert.com | Web: www.lcs-cert.com.

Scan code to check authenticity.

**4.2. OVERVIEW OF RESULTS**

EMISSION TESTS - EN IEC 55015, EN IEC 61000-3-2, EN 61000-3-3		
Requirement - Test case	Limit	Verdict
Conducted Disturbance - electric power supply	Table 1, Table 4	PASS
Conducted Disturbance - wired network ports at other than power supply	Table 2, Table 3	N/A
Conducted Disturbance - local wired ports at other than electrical power supply interface of ELV lamp	Table 5, Table 6	N/A
Assessment of the enclosure port	---	---
Radiated Disturbance in the frequency range 9 kHz to 30 MHz	Table 8, Table 9	PASS
Radiated Disturbance in the frequency range 30 MHz to 1 GHz	Table 10	PASS
Harmonic Current	Clause 7	PASS
Voltage Fluctuations and Flicker ²	Clause 5	N/A
IMMUNITY TESTS - EN 61547		
Requirement - Test case	Basic Standard(s)	Verdict
Electrostatic Discharge	IEC/EN 61000-4-2	PASS
Radio-Frequency Electromagnetic Fields	IEC/EN 61000-4-3	PASS
Electrical Fast Transient / Burst	IEC/EN 61000-4-4	PASS
Surge	IEC/EN 61000-4-5	PASS
Injected Currents (Radio-Frequency Common Mode)	IEC/EN 61000-4-6	PASS
Power Frequency Magnetic Field ¹	IEC/EN 61000-4-8	N/A
Voltage Dips and Short Interruptions	IEC/EN 61000-4-11	PASS

Supplementary information:

- 1) Only need to be applied to equipment containing components susceptible to magnetic fields.
- 2) According to EN 61000-3-3:2013+A1:2019+A2:2021 Clause A.2, Incandescent lamp luminaires with ratings less than or equal to 1000W and discharge and LED lamp luminaires with ratings less than or equal to 600W, are deemed to comply with the standard and are not required to be tested.



Shenzhen Southern LCS Compliance Testing Laboratory Ltd.

101-201, No. 39 Building, Xialang Industrial Zone, Heshuikou Community, Matian Street, Guangming District, Shenzhen, China.

Tel: +(86) 0755-82591330 | E-mail: webmaster@lcs-cert.com | Web: www.lcs-cert.com.

Scan code to check authenticity.



5. EMISSION TESTS

5.1. CONDUCTED DISTURBANCE

Standard	EN IEC 55015:2019+A11:2020
Basic Standard(s)	EN 55016-2-1

Disturbance voltage limits at the electric power supply interface

Frequency range [MHz]	Limit: Quasi-peak [dB(μV)]	Limit: Average[dB(μV)]	IF BW
0,009 - 0,05	110	N/A	200 Hz
0,05 - 0,15	90 - 80	N/A	200 Hz
0,15 - 0,5	66 - 56	56 - 46	9 kHz
0,5 - 5,0	56	46	9 kHz
5,0 - 30	60	50	9 kHz

- 1) At the transition frequency, the lower limit applies.
- 2) The limit decreases linearly with the logarithm of the frequency in the ranges 50 kHz to 150 kHz and 150 kHz to 0,5 MHz.
- 3) If the EUT is non-restricted ELV lamps, the limits add 26dB.

Disturbance voltage limits at wired network interfaces other than power supply

Frequency range [MHz]	Limit: Quasi-peak [dB(μV)]	Limit: Average[dB(μV)]	IF BW
0,15 - 5,0	84 - 74	74 - 64	9 kHz
5,0 - 30	74	64	9 kHz

- 1) The limits decrease linearly with the logarithm of the frequency in the range 0.15 MHz to 0.5 MHz.
- 2) The disturbance voltage limits are derived for use with an artificial asymmetrical network (AAN) which presents a common mode (asymmetric mode) impedance of 150 Ω to the measured interface.

Disturbance current limits at wired network interfaces other than power supply

Frequency range [MHz]	Limit: Quasi-peak [dB(μA)]	Limit: Average[dB(μA)]	IF BW
0,15 - 5,0	40 - 30	30 - 20	9 kHz
5,0 - 30	30	20	9 kHz

- 1) The limits decrease linearly with the logarithm of the frequency in the range 0.15MHz to 0.5 MHz.

Disturbance voltage limits at local wired ports: local wired ports other than electrical power supply interface of ELV lamp

Frequency range [MHz]	Limit: Quasi-peak [dB(μV)]	Limit: Average[dB(μV)]	IF BW
0,15 - 5,0	80	70	9 kHz
5,0 - 30	74	64	9 kHz

- 1) At the transition frequency, the lower limit applies.



Test configuration

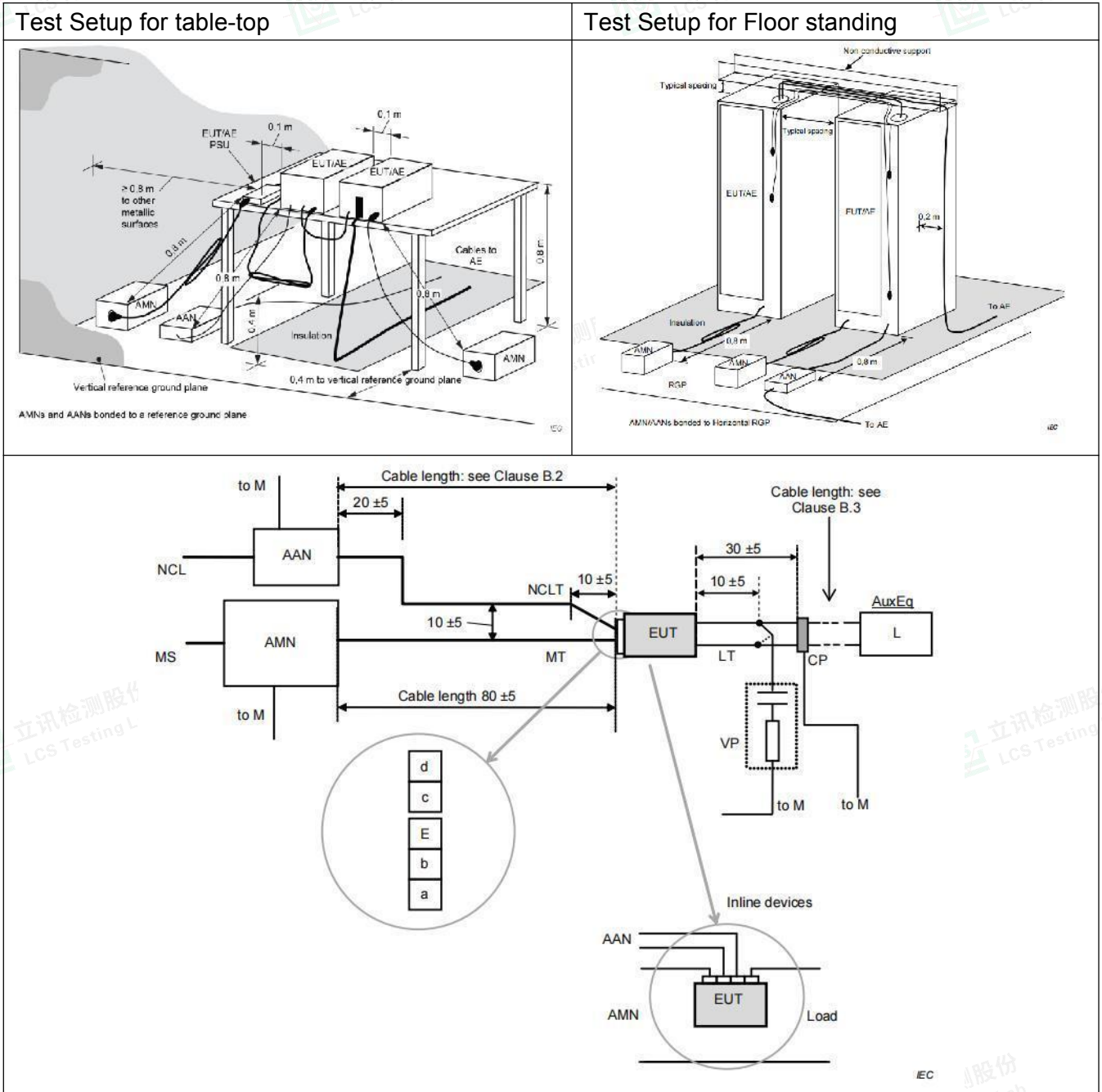

Test Procedure Description

For Table-top, EUT shall be placed at $(0,8 \pm 0,05)$ m above the reference plane of the test site selected for measurement. for Floor standing, EUT shall be placed at $(0,12 \pm 0,04)$ m above the reference plane of the test site selected for measurement. and connected to the AC mains through artificial mains network (LISN). EUT is powered by V-type artificial power network, and the distance from LISN or ANN is 0,8m. the part of the EUT power cord exceeding 0,8m folds in parallel to form a 0,3-0,4 m eights harness.

Test Results refer to Annex A.1



5.2. RADIATED DISTURBANCE (9KHz - 30MHz)

Standard	EN IEC 55015:2019+A11:2020
Basic Standard(s)	EN 55016-2-3
Test method	Large Loop Antenna (LLA)

LLAS Radiated disturbance limits (2m)

Frequency range [MHz]	Limit: Quasi-peak [dB(μA)]	IF BW
0,009 - 0,07	88	200 Hz
0,07 - 0,15	88 - 58	200 Hz
0,15 - 3,0	58 - 22	9 kHz
3,0 - 30	22	9 kHz

- 1) At the transition frequency the lower limit applies.
- 2) Decreasing linearly with logarithm of the frequency.

Test configuration

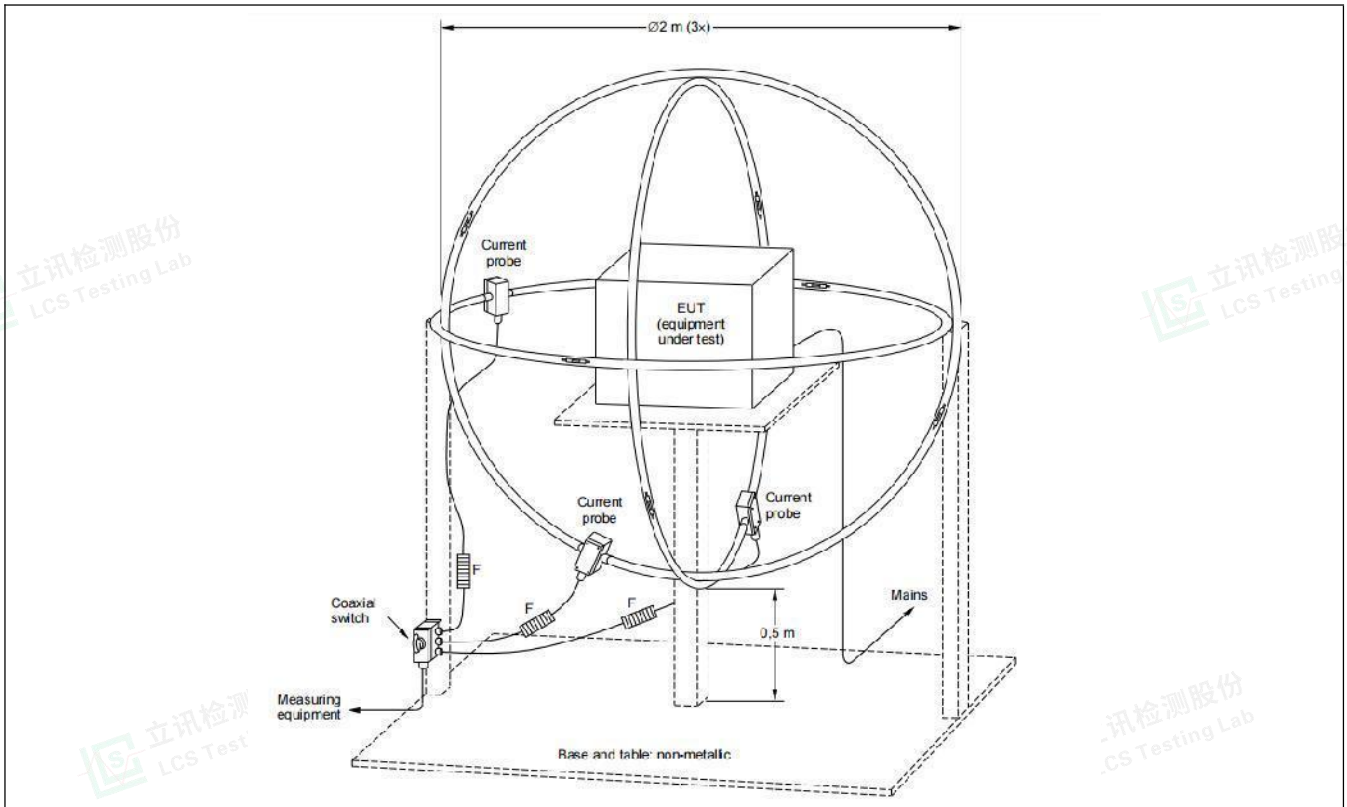

Test Procedure Description

The EUT is placed on a wood table in the center of a loop antenna. the induced current in the loop antenna is measured by means of a current probe and the test receiver. Three field components are checked by means of a coaxial switch.

Test Results refer to Annex A.2



5.3. RADIATED DISTURBANCE (30MHz - 1GHz)

Standard	EN IEC 55015:2019+A11:2020
Basic Standard(s)	EN 55016-2-3
Test method	Semi Anechoic Chamber (SAC)

SAC Radiated disturbance limit

Frequency range [MHz]	Limit: Quasi-peak [dB(μV/m)]		IF BW
	3 m distance	10 m distance	
30 - 230	40	30	120 KHz
230 - 1000	47	37	120 KHz

- 1) At the transition frequency, the lower limit applies.
- 2) Distance refers to the distance in meters between the measuring instrument antenna geometric center and the closed point of any part of the EUT.

Test configuration

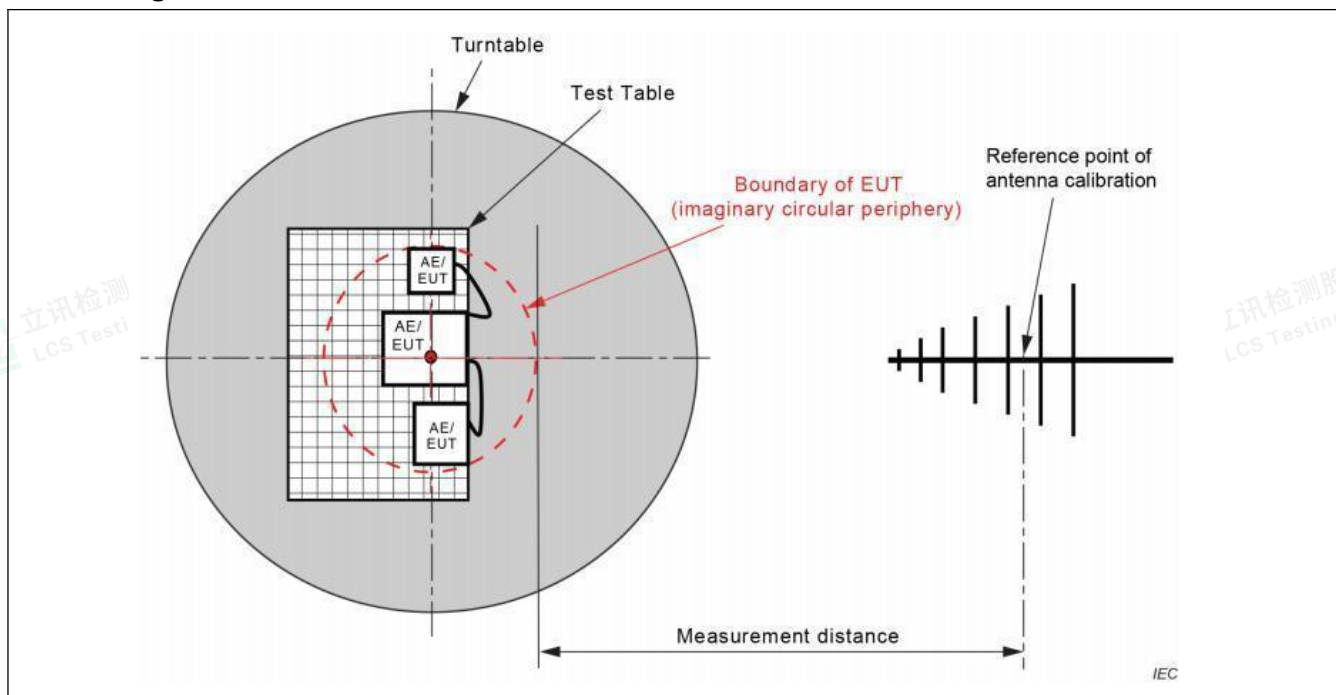

Test Procedure Description

The radiated disturbance test was conducted in a 3m Semi Anechoic Chamber and conforming to CISPR 16-2-3. the EUT is placed on a turntable, which is 0.8 meter high above the ground. the turntable can rotate 360 degrees to determine the position of the maximum emission level. the EUT is set 3 meters away from the receiving antenna, which is mounted on an antenna tower. the antenna can be moved up and down from 1 to 4 meters to find out the maximum emission level. Log-periodic Antenna (calibrated by Dipole antenna) is used as a receiving antenna. both horizontal and vertical polarization of the antenna is set on test.

Test Results refer to Annex A.3





5.4. HARMONIC CURRENT

Standard	EN IEC 61000-3-2:2019+A1:2021	
Exclusions (For these categories of equipment, limits are not specified in the EN IEC 61000-3-2)	<input type="checkbox"/>	Systems with nominal voltages less than 220V _{AC} (line-to-neutral)
	<input type="checkbox"/>	Lighting equipment with rated power < 5 W
	<input type="checkbox"/>	Equipment with rated power of ≤ 75 W (other than lighting equipment)
	<input type="checkbox"/>	Professional equipment with a total rated power >1kW
	<input type="checkbox"/>	Symmetrically controlled heating elements with rated power ≤ 200 W
	<input type="checkbox"/>	Independent dimmers for incandescent lamps with rated power ≤ 1kW

Classification		
<input type="checkbox"/>	Class A	All equipment not specified as belonging to Class B, C or D
<input type="checkbox"/>	Class B	Portable tools
<input checked="" type="checkbox"/>	Class C	<input checked="" type="checkbox"/> Lighting equipment with active input power > 25W
		<input type="checkbox"/> Lighting equipment with active input power ≥ 5W and ≤ 25W
		<input type="checkbox"/> Table 3, column 2 (Power-related limits)
		<input type="checkbox"/> 3rd harmonic ≤ 86%, 5th harmonic ≤ 61% and waveform conditions
<input type="checkbox"/>	Class D	Personal computers, television receivers, refrigerators and freezers having one or more variable-speed drives to control compressor

Test configuration

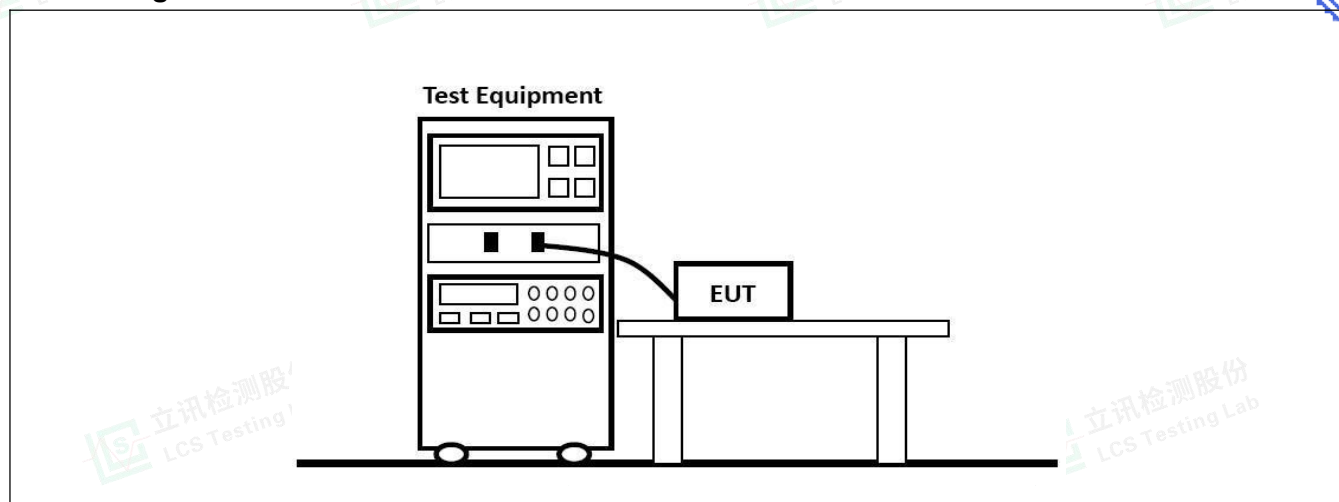

Test Results refer to Annex A.4





5.5. VOLTAGE FLUCTUATIONS & FLICKER

Standard	EN 61000-3-3:2013+A1:2019+A2:2021
----------	-----------------------------------

Limit

P _{st} (Short term flicker)	<input type="checkbox"/>	≤ 1	<input checked="" type="checkbox"/>	Not applicable
P _{lt} (Long-term flicker)	<input type="checkbox"/>	≤ 0,65	<input checked="" type="checkbox"/>	Not applicable
T _{max} (Accumulated time)	<input type="checkbox"/>	≤ 500 ms	<input checked="" type="checkbox"/>	Not applicable
d _c (Relative voltage change)	<input type="checkbox"/>	≤ 3.3%	<input checked="" type="checkbox"/>	Not applicable
d _{max} (Max.voltage change)	<input type="checkbox"/>	≤ 4%	<input type="checkbox"/>	≤ 6%
	<input type="checkbox"/>	≤ 7%	<input checked="" type="checkbox"/>	Not applicable

Test configuration

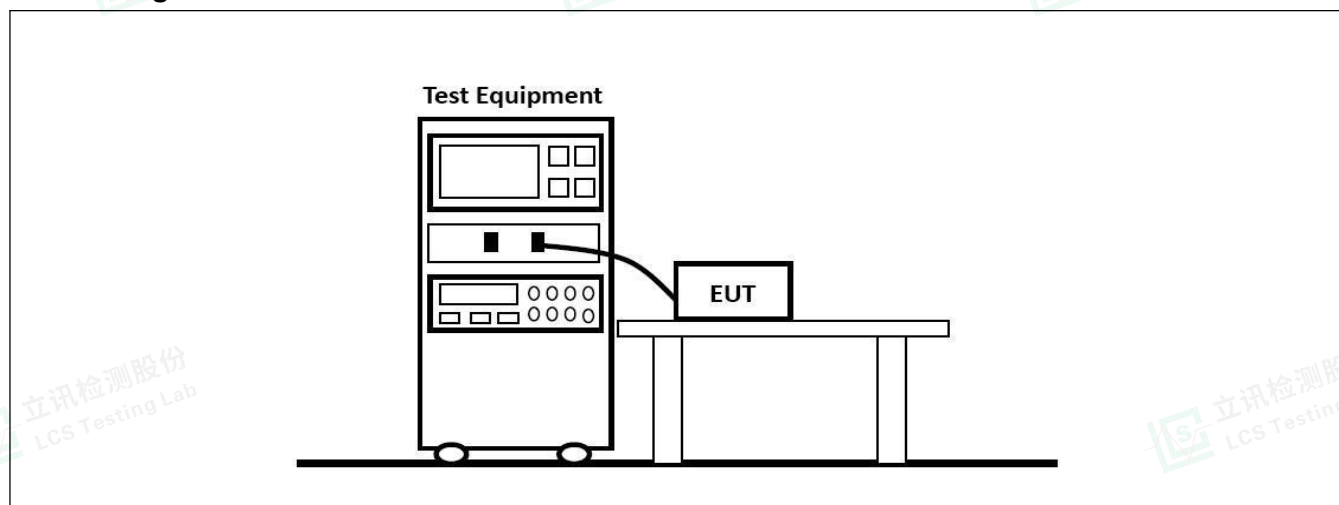



6. IMMUNITY TESTS

6.1. PERFORMANCE CRITERIA

Standard	EN 61547:2009
----------	---------------

The performance of lighting equipment shall be assessed by monitoring:

- the luminous intensity of the luminaire or of the lamp(s).
- the functioning of the control in the case of equipment which includes a regulating control or concerns the regulating control itself.
- the functioning of the starting device, if any.

Performance criterion A: during the test, no change of the luminous intensity shall be observed and the regulating control, if any, shall operate during the test as intended.

Performance criterion B: during the test, the luminous intensity may change to any value. after the test, the luminous intensity shall be restored to its initial value within 1 min. regulating controls need not function during the test, but after the test, the mode of the control shall be the same as before the test provided that during the test no mode changing commands were given.

Performance criterion C: during and after the test, any change of the luminous intensity is allowed and the lamp(s) may be extinguished. after the test, within 30 min, all functions shall return to normal, if necessary by temporary interruption of the mains supply and / or operating the regulating control.

Electronic lighting equipment		Tests and performance criteria							
		5.2 (ESD)	5.3 (RS)	5.4 (PFMF)	5.5 (EFT)	5.6 (CS)	5.7 (Surge)	5.8 (Dips)	5.9 (Interruption)
<input type="checkbox"/>	Self-ballasted lamps	B	A	B	B	A	C	C	B
<input type="checkbox"/>	Independent auxiliaries	B	A	B	B	A	C	C	B ¹
<input checked="" type="checkbox"/>	Luminaire including active electronic components	B	A	B	B	A	C	C	B ¹
<input type="checkbox"/>	Luminaire for emergency lighting	B ²	A	B	B ²	A	B ²	See ³	See ³

Supplementary information:

- 1) For ballasts where the lamp is not able to restart within 1 min, due to the physical constraints of the lamp, performance criterion C applies.
- 2) Luminaires for emergency lighting shall be tested in both the normal and emergency mode of operation.
- 3) These tests do not apply as they are covered by the test in IEC 60598-2-22.
- 4) For emergency luminaires designed to operate in high-risk task areas, after the test, the luminous intensity shall be restored to its initial value within 0,5 s.



6.2. ELECTROSTATIC DISCHARGE

Electrostatic discharge (ESD) is the result of accumulated static electricity from a person or object, for example, walking on a synthetic carpet. ESD can indirectly affect the operation of equipment or damage its electronic components through direct discharge or coupling. Both effects were simulated during the test. Contact discharge is the preferred test method. Twenty discharges (10 with positive and 10 with negative polarity) shall be applied on each accessible metallic part of the enclosure (terminals are excluded). Air discharges shall be used where contact discharges cannot be applied. Discharges shall be applied on the horizontal or vertical coupling planes.

Requirements

Standard	EN 61547:2009							
Basic standard	EN 61000-4-2							
Port under test	Enclosure							
Contact discharge	<input checked="" type="checkbox"/>	± 2 kV	<input checked="" type="checkbox"/>	± 4 kV	<input type="checkbox"/>	±8 kV	<input type="checkbox"/>	±15 kV
Air discharge	<input checked="" type="checkbox"/>	± 2 kV	<input checked="" type="checkbox"/>	± 4 kV	<input checked="" type="checkbox"/>	±8 kV	<input type="checkbox"/>	±15 kV
Number of discharges	≥ 10 per polarity with ≥ 1 sec interval							

Test configuration

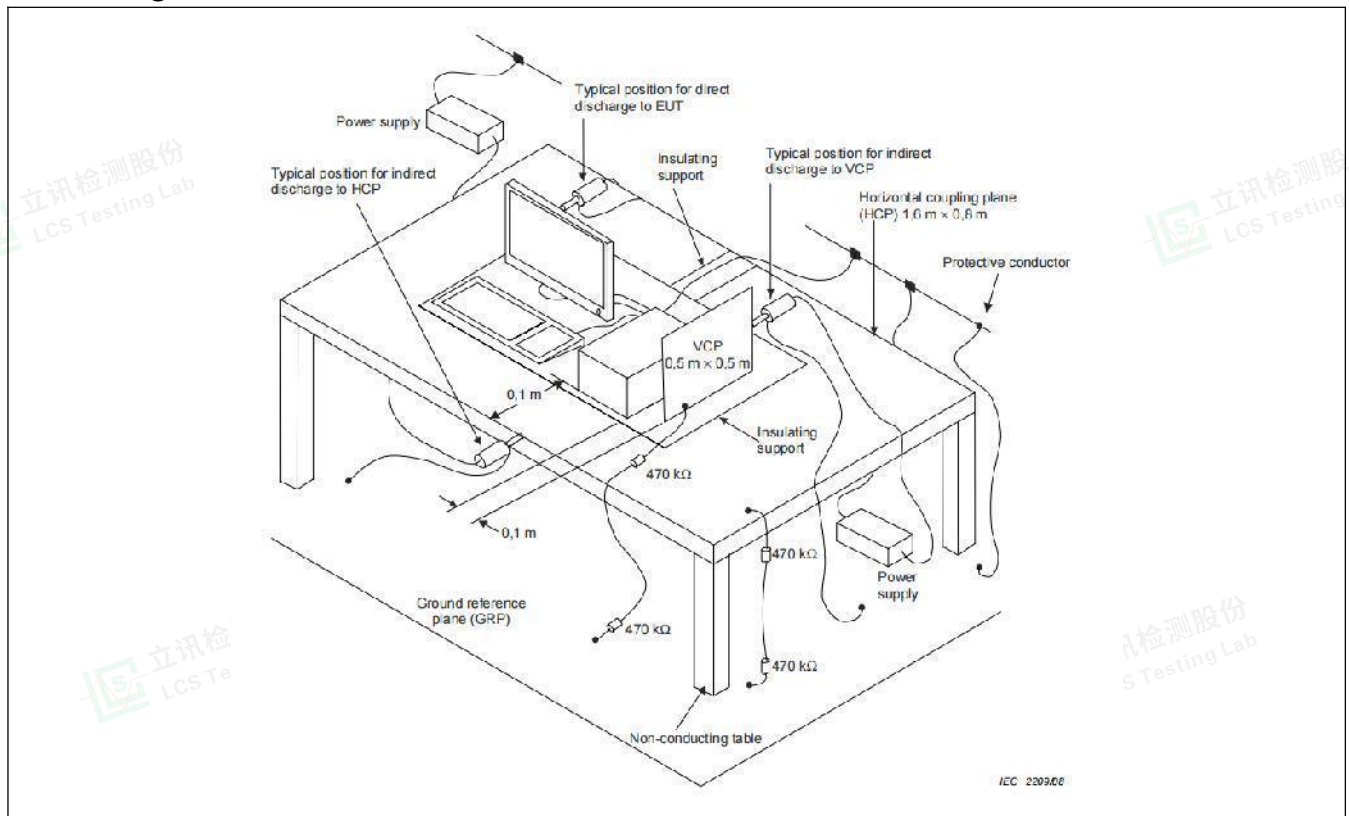

Test Results refer to Annex A.5



6.3. RADIO-FREQUENCY ELECTROMAGNETIC FIELDS

During the test it is verified if the EUT has sufficient immunity against radiated electromagnetic fields.

The test was carried out in a half-wave anechoic chamber with absorbent material attached to a reflective ground plane. Before the test, the test field strength needs to be calibrated. during the calibration, the corresponding relationship between the target field strength and the forward power applied to the transmitting antenna is established. during the test, except for EUT, the indoor layout is consistent with the calibration.

The EUT and its simulators are placed on a turn table which is 0,8 meter above ground. EUT is set 3 meter away from the transmitting antenna which is mounted on an antenna tower. both horizontal and vertical polarization of the antenna are set on test. each of the four sides of EUT must be faced this transmitting antenna and measured individually. in order to judge the EUT performance, a CCD camera is used to monitor EUT screen.

Requirements

Standard	EN 61547:2009			
Basic standard	EN 61000-4-3			
Port under test	Enclosure			
Frequency range	Test level	Modulation	Dwell time	Step size
80 - 1000 MHz	3 V/m	1 kHz, 80 % AM	≥ 0,5 s	≤ 1%

Test configuration

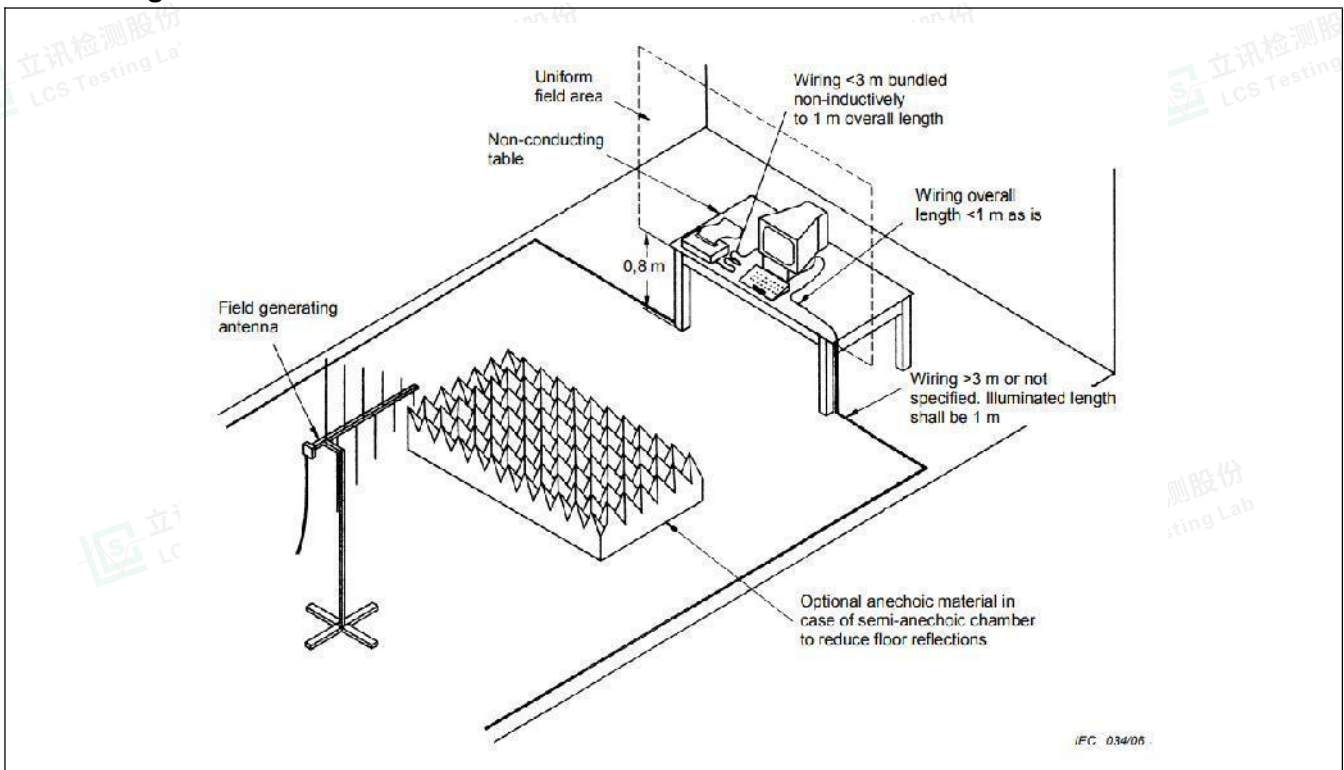

Test Results refer to Annex A.5



6.4. ELECTRICAL FAST TRANSIENT / BURST

The EFT immunity test simulates the disturbances by caused of very short transient bursts.

The EUT is put on the Insulating support which is 0.1 meter high above the ground reference plane. the minimum distance between EUT and all other conductive structure, except the ground plane beneath the EUT, shall be more than 0.5 m. both polarities of the test voltage should be applied during test, fast transients are carried out with a minimum duration of 2 min with a positive polarity and a minimum of 2 min with a negative polarity.

Requirements

Standard	EN 61547:2009			
Basic standard	EN 61000-4-4			
Pulse characteristics	5/50 ns			
Port under test	Test level	Repetition frequency	Duration	
<input checked="" type="checkbox"/> AC input / output power	± 1000 V	5 kHz	2 min / polarity	
<input type="checkbox"/> DC input / output power ²	± 500 V	5 kHz	2 min / polarity	
<input type="checkbox"/> Signal / Control port ^{1 3}	± 500 V	5 kHz	2 min / polarity	

- 1) Only applicable to ports interfacing with cables whose whose total length may exceed 3 m.
- 2) Not applicable to equipment not connected to the mains while in use.
- 3) Change of state commands are not applied during the test.

Test configuration

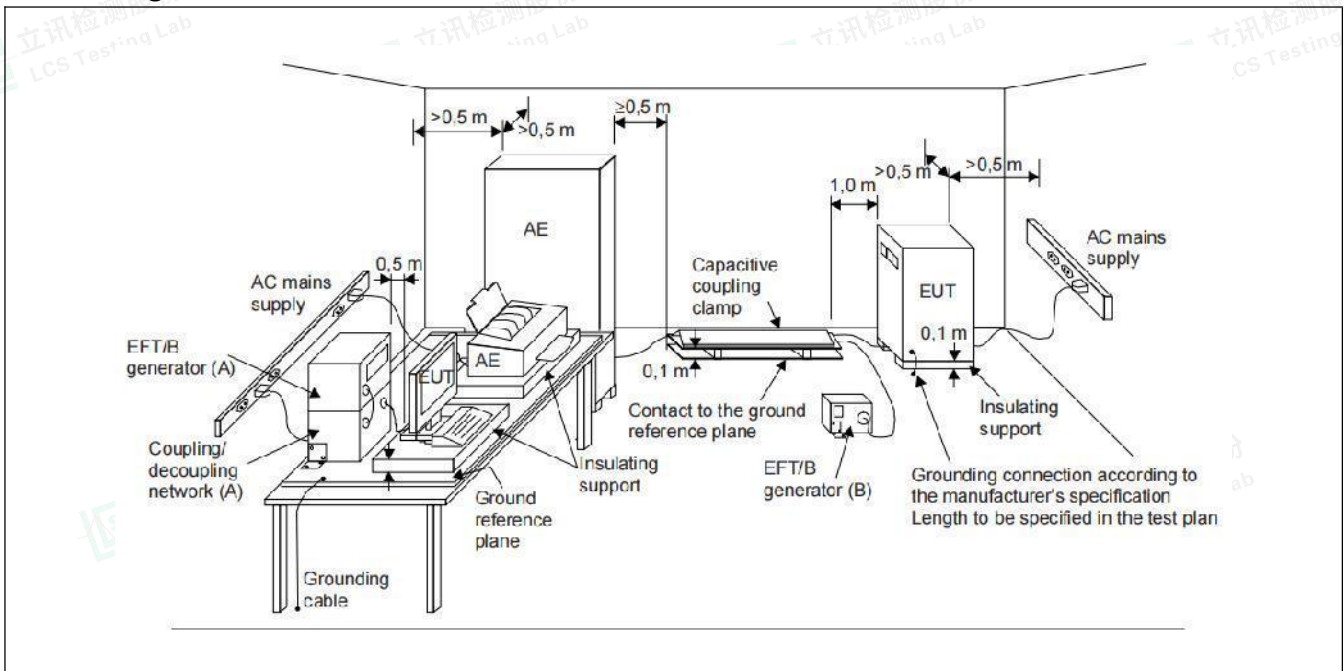

Test Results refer to Annex A.5



6.5. INJECTED CURRENTS (RADIO-FREQUENCY COMMON MODE)

During the test the immunity of the EUT for conducted electromagnetic fields is checked .

The equipment to be tested is placed on an insulating support of $0,1\text{ m} \pm 0,05\text{ m}$ height above a reference ground plane. a non conductive roller / caster in the range of $0,1\text{ m} \pm 0,05\text{ m}$ above the reference ground plane can be used as an alternative to an insulating support. all cables exiting the EUT shall be supported at a height of at least 30 mm above the reference ground plane. The coupling and decoupling devices shall be placed on the reference ground plane, making direct contact with it at a distance of 0,1 m to 0,3 m from the EUT.

Requirements

Standard	EN 61547:2009				
Basic standard	EN 61000-4-6				
Frequency range	0,15 - 80 MHz				
Port under test	Test level	Modulation	Dwell time	Step size	
<input checked="" type="checkbox"/> AC input / output power	3 V	1 kHz, 80 % AM	$\geq 0,5\text{ s}$	$\leq 1\%$	
<input type="checkbox"/> DC input / output power ¹	3 V	1 kHz, 80 % AM	$\geq 0,5\text{ s}$	$\leq 1\%$	
<input type="checkbox"/> Signal / Control port ²	3 V	1 kHz, 80 % AM	$\geq 0,5\text{ s}$	$\leq 1\%$	

1) Not applicable to equipment not connected to the mains while in use.
 2) Only applicable to ports interfacing with cables whose whose total length may exceed 3 m.

Test configuration

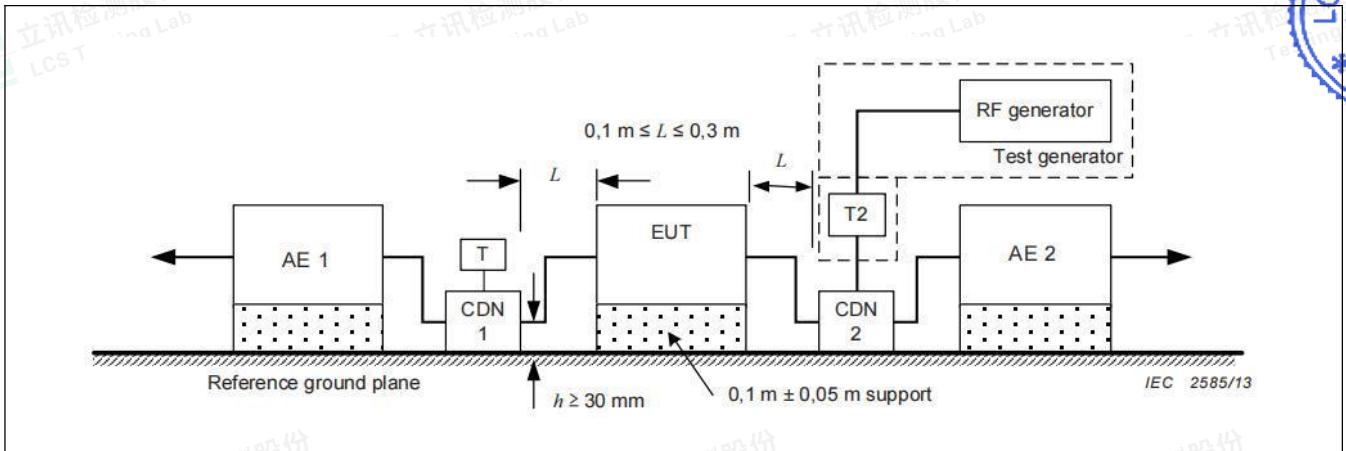

Test Results refer to Annex A.5



6.6. SURGE

The surge immunity test simulates unidirectional surges caused by overvoltages from switching and lightning transients.

The surge is applied to the EUT power supply terminal via the capacitive coupling network, to the EUT power supply provide a 1,0 kV 1,2/50us voltage surge (at open-circuit condition), at least 5 positive and 5 negative tests with 1 min or less repetition rate are conducted during test. and phase angles is 90° and 270°.

Requirements

Standard		EN 61547:2009			
Basic standard		EN 61000-4-5			
Pulse wave-shape		1,2/50 μs			
Repetition rate		1 per minute or faster			
Number of pulses		5 pulses (at each polarity and phase angles)			
Classification		Port under test	Test Level	Coupling	Phase angle
☒	Luminaires and independent auxiliaries Input power >25W	AC input power	+ 1 kV	line - line	90°
			- 1 kV	line - line	270°
		AC input power	+ 2 kV	line - ground	90°
			- 2 kV	line - ground	270°
☐	Luminaires and independent auxiliaries Input power ≤25W	AC input power	+ 0,5 kV	line - line	90°
			- 0,5 kV	line - line	270°
		AC input power	+ 1 kV	line - ground	90°
			- 1 kV	line - ground	270°
☐	Self-ballasted lamps and semi-luminaires	AC input power	+ 0,5 kV	line - line	90°
			- 0,5 kV	line - line	270°
		AC input power	+ 1 kV	line - ground	90°
			- 1 kV	line - ground	270°

1) In addition to the specified test level, all lower test levels as detailed in EN 61000-4-5 should also be satisfied.

Test configuration

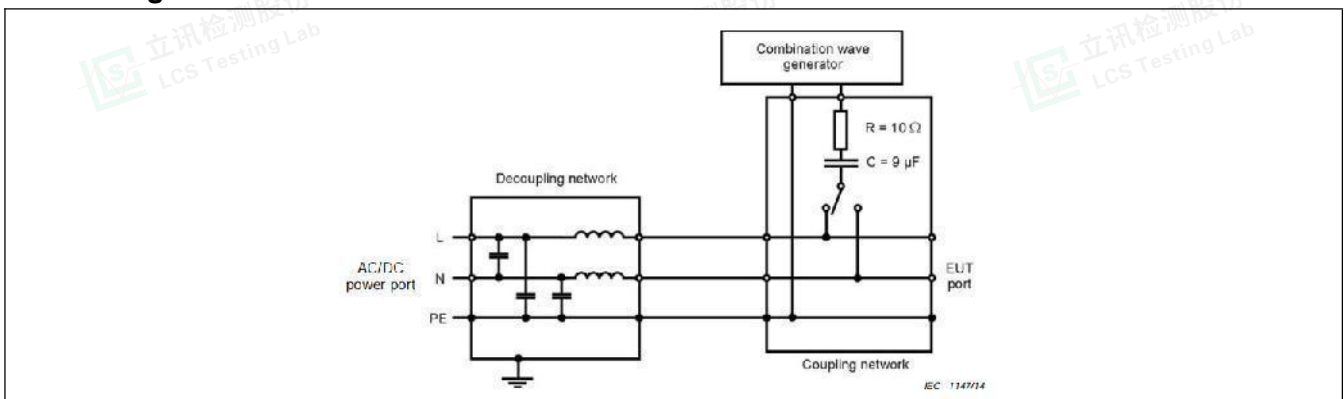

Test Results refer to Annex A.5



6.7. VOLTAGE DIPS AND SHORT INTERRUPTIONS

The surge immunity test simulates Voltage dips and short interruptions occur due to faults in a (public or non-public) network or in installations by sudden changes of large loads.

The EUT shall be connected to the test generator for testing using the shortest power cable specified by the EUT manufacturer and, if no cable length is specified, the shortest cable suitable for the EUT, each representative mode of operation shall be tested. for short interruptions to use 0° for one of the phases.

Requirements

Standard	EN 61547:2009		
Basic standard	EN 61000-4-11		
# of dips / interruptions	3 dips / interruptions for each test level and phase angle		
Intervals between events	≥ 10 s		
Port under test	Test level ¹	Number of periods (cycles)	
		50Hz	60Hz
AC input power	70% of U _{NOM}	10	12
	0% of U _{NOM}	0,5	0,5

- 1) Where the equipment has a rated voltage range the following shall apply:
- If the voltage range does not exceed 20 % of the lower voltage specified for the rated voltage range, a single voltage within that range may be specified as a basis for the test level specification.
 - in all other cases, the test procedure shall be applied for both the lowest and highest voltages declared in the voltage range.

Test configuration

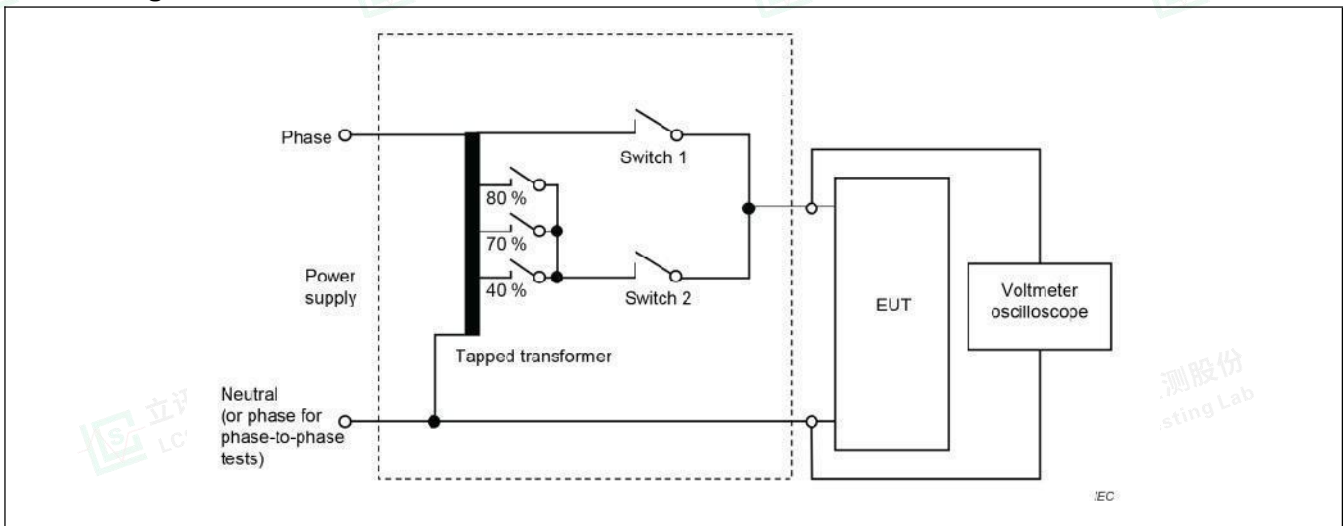

Test Results refer to Annex A.5





ANNEX A - TEST RESULTS

A.1. CONDUCTED DISTURBANCE TEST RESULTS

Environmental Conditions	24.5°C, 52% RH
Model	VT-101-2D
Operating mode	Mode 1 (worst case)
Test voltage	AC 230V,50Hz
Test engineer	Zom Zhang
Pol	Line

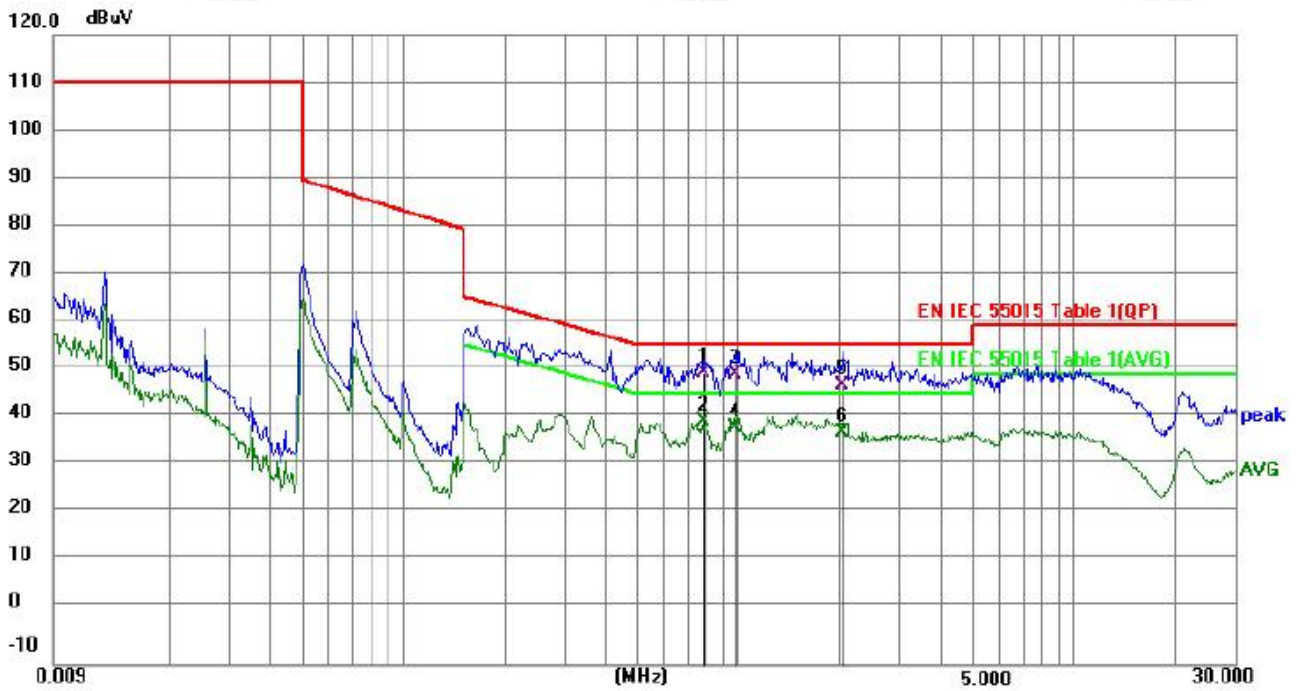

No.	Mk.	Freq. MHz	Reading Level dB	Correct Factor dB	Measure- ment dBuV	Limit dBuV	Over dB	Detector	Comment
1	*	0.7865	39.21	10.94	50.15	56.00	-5.85	QP	
2		0.7865	29.17	10.94	40.11	46.00	-5.89	AVG	
3		0.9821	39.00	10.96	49.96	56.00	-6.04	QP	
4		0.9821	27.94	10.96	38.90	46.00	-7.10	AVG	
5		2.0223	36.66	10.94	47.60	56.00	-8.40	QP	
6		2.0223	27.06	10.94	38.00	46.00	-8.00	AVG	





Environmental Conditions	24.5°C, 52% RH
Model	VT-101-2D
Operating mode	Mode 1 (worst case)
Test voltage	AC 230V,50Hz
Test engineer	Zom Zhang
Pol	Neutral

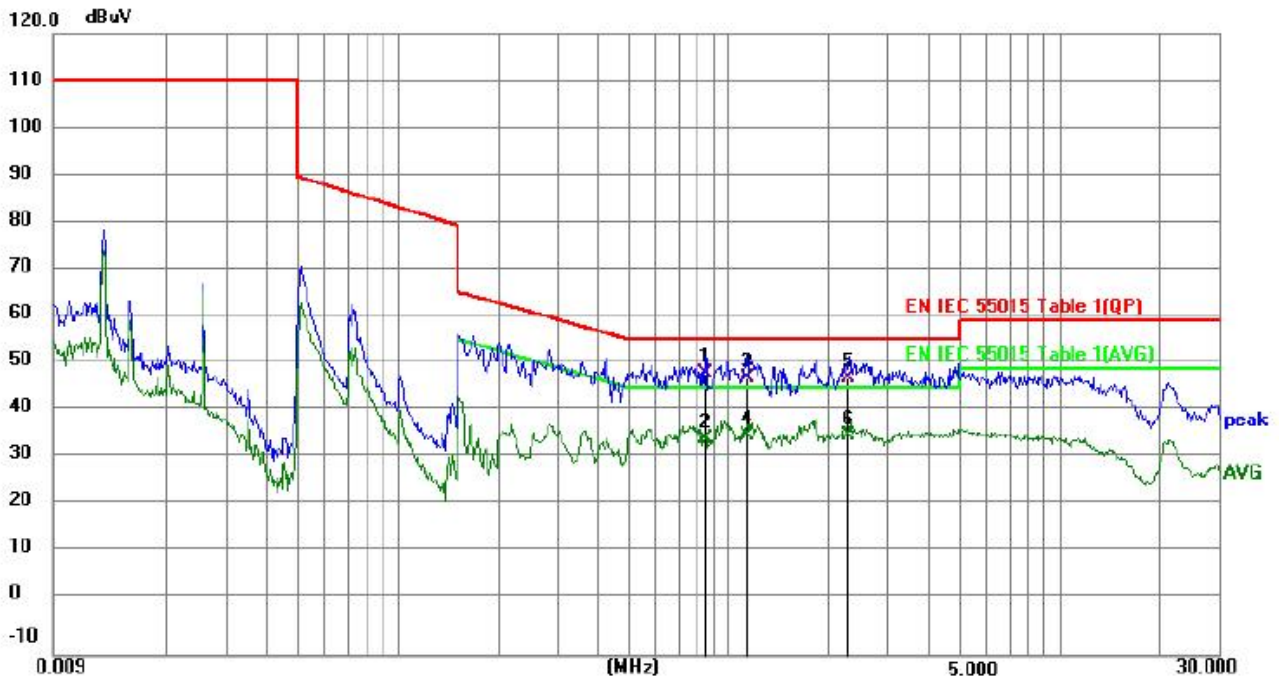

No.	Mk.	Freq. MHz	Reading Level	Correct Factor dB	Measure- ment dBuV	Limit dBuV	Over dB	Detector	Comment
1	*	0.8430	37.96	10.94	48.90	56.00	-7.10	QP	
2		0.8430	24.56	10.94	35.50	46.00	-10.50	AVG	
3		1.1310	36.92	10.96	47.88	56.00	-8.12	QP	
4		1.1310	25.14	10.96	36.10	46.00	-9.90	AVG	
5		2.3044	36.95	10.95	47.90	56.00	-8.10	QP	
6		2.3044	24.96	10.95	35.91	46.00	-10.09	AVG	





A.2. RADIATED DISTURBANCE TEST RESULTS (9kHz - 30MHz)

Environmental Conditions	24.5°C, 52% RH
Model	VT-101-2D
Operating mode	Mode 1 (worst case)
Test voltage	AC 230V,50Hz
Test engineer	Zom Zhang
Pol	X

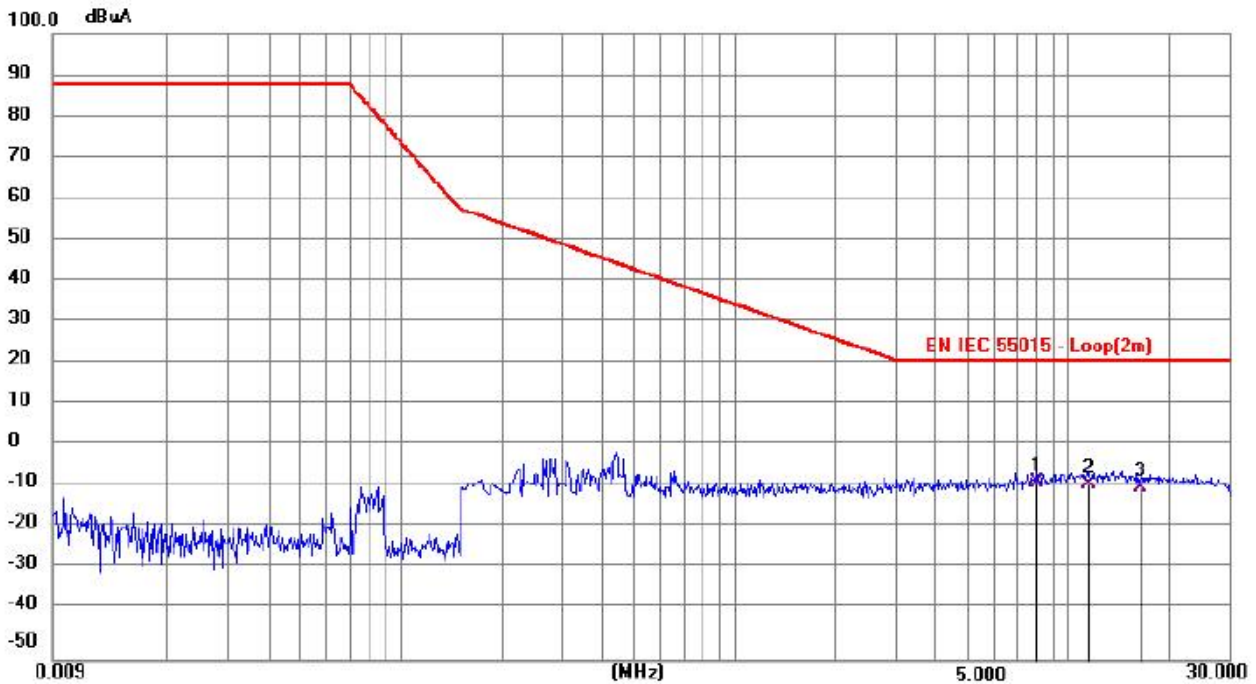

No.	Mk.	Freq. MHz	Reading Level dBuV	Correct Factor dB	Measure- ment dBuA	Limit dBuA	Over dB	Detector	Comment
1	*	8.0024	-32.70	25.20	-7.50	22.00	-29.50	QP	
2		11.4180	-34.01	26.06	-7.95	22.00	-29.95	QP	
3		16.3590	-34.05	25.56	-8.49	22.00	-30.49	QP	





Environmental Conditions	24.5°C, 52% RH
Model	VT-101-2D
Operating mode	Mode 1 (worst case)
Test voltage	AC 230V,50Hz
Test engineer	Zom Zhang
Pol	Y

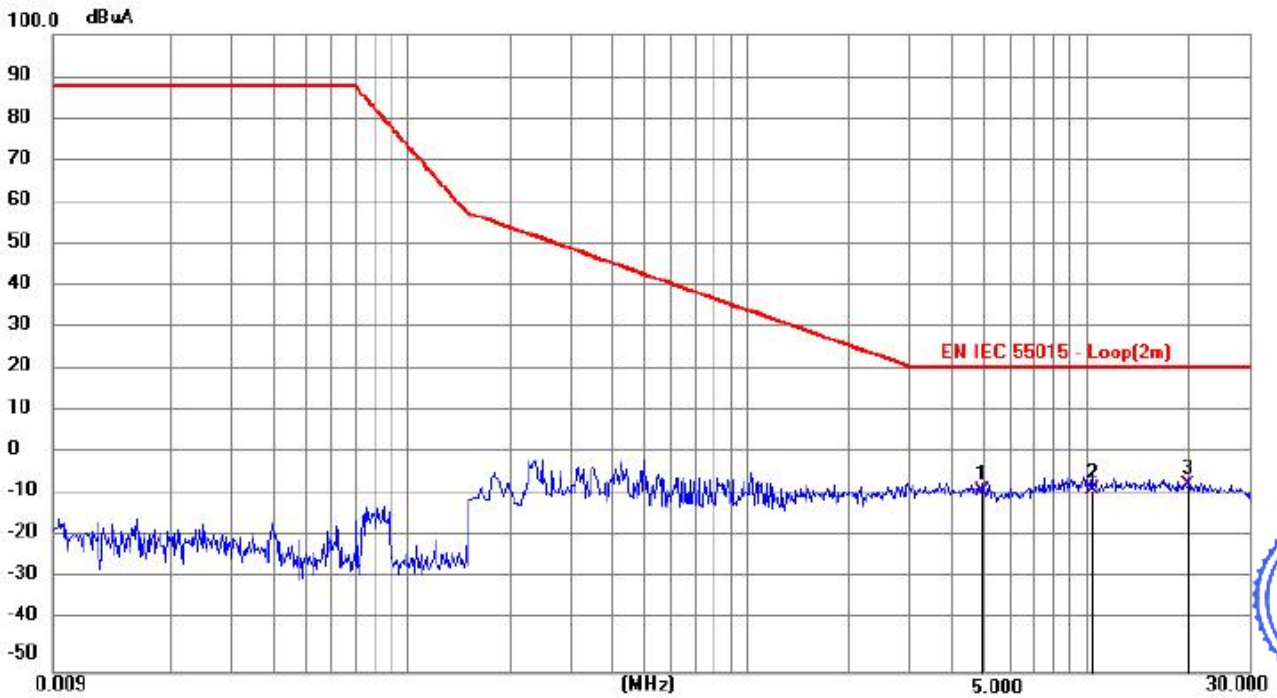

No.	Mk.	Freq. MHz	Reading Level dBuV	Correct Factor dB	Measure- ment dBuA	Limit dBuA	Over dB	Detector	Comment
1		4.9245	-33.16	25.64	-7.52	22.00	-29.52	QP	
2		10.3605	-33.31	26.37	-6.94	22.00	-28.94	QP	
3	*	19.8690	-31.61	25.61	-6.00	22.00	-28.00	QP	





Environmental Conditions	24.5°C, 52% RH
Model	VT-101-2D
Operating mode	Mode 1 (worst case)
Test voltage	AC 230V,50Hz
Test engineer	Zom Zhang
Pol	Z



No.	Mk.	Freq. MHz	Reading Level dBuV	Correct Factor dB	Measure- ment dBuA	Limit dBuA	Over dB	Detector	Comment
1		9.2624	-35.55	26.70	-8.85	22.00	-30.85	QP	
2	*	15.4815	-34.39	26.34	-8.05	22.00	-30.05	QP	
3		24.1395	-33.00	24.81	-8.19	22.00	-30.19	QP	





A.3. RADIATED DISTURBANCE TEST RESULTS (30MHz - 1GHz)

Environmental Conditions	24.0°C, 51% RH
Model	VT-101-2D
Operating mode	Mode 1 (worst case)
Test voltage	AC 230V,50Hz
Test engineer	Zom Zhang
Pol	Vertical



No.	Mk.	Freq.	Reading Level	Correct Factor	Measurement	Limit	Margin	Antenna Height	Table Degree	
		MHz	dBuV	dB/m	dBuV/m	dBuV/m	dB	cm	degree	Comment
1	*	30.8941	22.30	10.54	32.84	40.00	-7.16	QP		
2		39.9417	20.13	11.99	32.12	40.00	-7.88	QP		
3		66.1211	14.77	10.89	25.66	40.00	-14.34	QP		





Environmental Conditions	24.0°C, 51% RH
Model	VT-101-2D
Operating mode	Mode 1 (worst case)
Test voltage	AC 230V,50Hz
Test engineer	Zom Zhang
Pol	Horizontal



No.	Mk.	Freq. MHz	Reading Level dBuV	Correct Factor dB/m	Measure- ment dBuV/m	Limit dBuV/m	Margin dB	Detector	Antenna Height cm	Table Degree	Comment
1		115.7256	14.33	11.75	26.08	40.00	-13.92	QP			
2	*	176.7328	15.37	10.88	26.25	40.00	-13.75	QP			
3		222.2672	14.05	11.75	25.80	40.00	-14.20	QP			





A.4. HARMONIC CURRENT TEST RESULTS

Model	VT-101-2D
Operating mode	Mode 1
Test voltage	AC 230V,50Hz
Test engineer	Zom Zhang

Test Result: **Pass** Source qualification(Power On Load): **Idle - Pass**

Current & voltage waveforms

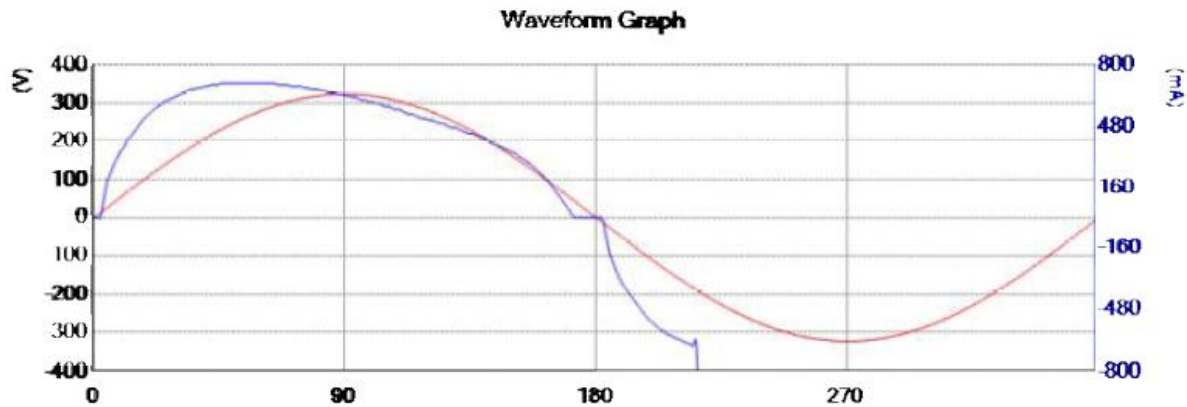

Harmonics and Class C limit line (>25W)

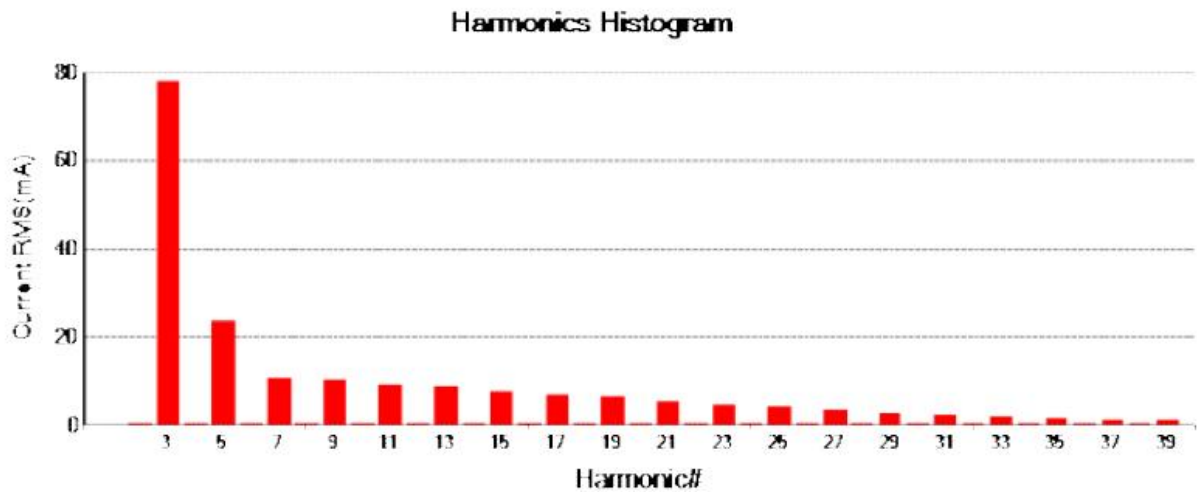



Model	VT-101-2D
Operating mode	Mode 1
Test voltage	AC 230V,50Hz
Test engineer	Zom Zhang

Test Result: **Pass**Source qualification(Power On Load): **Idle - Pass**

THC(mA): 85.350

I - THD(%): 17.2

POHC(mA):10.200

POHC Limit(mA):47.102

Parameter values during test:

V_RMS (Volts): 229.6

Frequency(Hz): 50.0

I_RMS(mA): 506.7

Crest Factor: 1.322

Power (Watts): 112.5

Power Factor: 0.967

Harm#	Harms(filtered) (mA)	Limit (mA)	Harms(avg) (mA)	100%Limit	Harms(max) (mA)	150%Limit	Status
L_Fund	496.500						
2	0.170	9.930	0.200	2.014	0.290	1.947	Pass
3	78.020	134.055	78.600	58.633	79.250	39.412	Pass
4	0.060	-	0.100	-	0.130	-	N/A
5	23.730	49.650	24.000	48.338	24.470	32.857	Pass
6	0.060	-	0.100	-	0.130	-	N/A
7	10.870	34.755	10.900	31.362	10.960	21.023	Pass
8	0.040	-	0.100	-	0.130	-	N/A
9	10.340	24.825	10.200	41.088	10.340	27.768	Pass
10	0.110	-	0.100	-	0.130	-	N/A
11	9.480	14.895	9.300	62.437	9.480	42.430	Pass
12	0.040	-	0.000	-	0.060	-	N/A
13	8.900	14.895	8.800	59.080	8.920	39.924	Pass
14	0.040	-	0.000	-	0.060	-	N/A
15	7.770	14.895	7.800	52.367	7.820	35.001	Pass
16	0.060	-	0.100	-	0.080	-	N/A
17	6.760	14.895	6.800	45.653	6.900	30.883	Pass
18	0.040	-	0.000	-	0.060	-	N/A
19	6.150	14.895	6.200	41.625	6.240	27.929	Pass
20	0.040	-	0.000	-	0.060	-	N/A
21	5.250	14.895	5.300	35.582	5.390	24.124	Pass
22	0.040	-	0.000	-	0.040	-	N/A
23	4.510	14.895	4.600	30.883	4.690	20.991	Pass
24	0.040	-	0.000	-	0.040	-	N/A
25	3.930	14.895	4.000	26.855	4.200	18.798	Pass
26	0.040	-	0.000	-	0.060	-	N/A
27	3.210	14.895	3.300	22.155	3.500	15.665	Pass
28	0.020	-	0.000	-	0.060	-	N/A
29	2.620	14.895	2.700	18.127	2.870	12.845	Pass
30	0.020	-	0.000	-	0.060	-	N/A
31	2.130	14.895	2.200	14.770	2.330	10.429	Pass
32	0.020	-	0.000	-	0.060	-	N/A
33	1.820	14.895	1.900	12.756	1.970	8.817	Pass
34	0.040	-	0.000	-	0.040	-	N/A
35	1.520	14.895	1.600	10.742	1.610	7.206	Pass
36	0.020	-	0.000	-	0.040	-	N/A
37	1.250	14.895	1.300	8.728	1.300	5.819	Pass
38	0.040	-	0.000	-	0.060	-	N/A
39	1.160	14.895	1.100	7.385	1.160	5.192	Pass
40	0.020	-	0.000	-	0.040	-	N/A

Note: All harmonics are below the minimum limits and are ignored.



Shenzhen Southern LCS Compliance Testing Laboratory Ltd.

101-201, No. 39 Building, Xialang Industrial Zone, Heshuikou Community, Matian Street, Guangming District, Shenzhen, China.

Tel: +(86) 0755-82591330 | E-mail: webmaster@lcs-cert.com | Web: www.lcs-cert.com.

Scan code to check authenticity.



Model	VT-101-2D
Operating mode	Mode 1
Test voltage	AC 230V,50Hz
Test engineer	Zom Zhang

Source qualification(Power On Load): **Pass**

Measurements are compliant with IEC/EN61000-3-2 Ed. 4 & IEC/EN61000-4-7 Ed. 2.1

	Nominal	Measured		Deviation	Allowed Deviation	Result
		Low	High			
Supply Voltage	230	229.33	229.61	0.67	4.6	Pass
Supply Frequency	50	50.0	50.0	0.0	0.25	Pass
Crest Phase	90.0	89.0	89.3	1.0	87 - 93	Pass
Crest Factor	1.414	1.414	1.415	0.001	1.40 - 1.42	Pass
Fundamental Voltage	229.43	-	-	-	-	-

Harm#	Harmonics Voltage	Harmonic Ratio	Limit	Result
2	0.070	0.055	0.200	Pass
3	0.130	0.060	0.900	Pass
4	0.040	0.031	0.200	Pass
5	0.010	0.025	0.400	Pass
6	0.010	0.018	0.200	Pass
7	0.010	0.012	0.300	Pass
8	0.010	0.008	0.200	Pass
9	0.000	0.008	0.200	Pass
10	0.020	0.013	0.100	Pass
11	0.030	0.013	0.100	Pass
12	0.000	0.003	0.100	Pass
13	0.020	0.008	0.100	Pass
14	0.000	0.003	0.100	Pass
15	0.000	0.003	0.100	Pass
16	0.000	0.005	0.100	Pass
17	0.010	0.005	0.100	Pass
18	0.000	0.000	0.100	Pass
19	0.000	0.003	0.100	Pass
20	0.000	0.000	0.100	Pass
21	0.010	0.003	0.100	Pass
22	0.000	0.000	0.100	Pass
23	0.000	0.003	0.100	Pass
24	0.000	0.000	0.100	Pass
25	0.000	0.003	0.100	Pass
26	0.000	0.000	0.100	Pass
27	0.000	0.003	0.100	Pass
28	0.000	0.000	0.100	Pass
29	0.000	0.003	0.100	Pass
30	0.000	0.000	0.100	Pass
31	0.000	0.003	0.100	Pass
32	0.000	0.000	0.100	Pass
33	0.000	0.000	0.100	Pass
34	0.000	0.000	0.100	Pass
35	0.000	0.000	0.100	Pass
36	0.000	0.000	0.100	Pass
37	0.000	0.000	0.100	Pass
38	0.000	0.000	0.100	Pass
39	0.000	0.000	0.100	Pass
40	0.000	0.000	0.100	Pass



**A.5. IMMUNITY TEST RESULTS**

ELECTROSTATIC DISCHARGE IMMUNITY TEST RESULTS					
Standard	<input checked="" type="checkbox"/> EN 61547:2009		<input checked="" type="checkbox"/> EN 61000-4-2		
EUT	LED PENDANT	Temperature	24.1°C		
M/N	VT-101-2D	Humidity	51%		
Test Mode	Mode 1	Pressure	1008mbar		
Input voltage	AC 230V,50Hz	Test Results	Pass		
Test engineer	Zom Zhang				
Discharge Mode	Test Points	Test Voltage (kV) & polarity	Number of discharges/polarity	Discharge interval (s)	Performance Criteria
Contact Discharge	Conductive surfaces	± 2&4	10	1	B
Air Discharge	Insulating surfaces	± 2&4&8	10	1	B
VCP	-	± 4	10	1	B
HCP	-	± 4	10	1	B



Shenzhen Southern LCS Compliance Testing Laboratory Ltd.

101-201, No. 39 Building, Xialang Industrial Zone, Heshuikou Community, Matian Street, Guangming District, Shenzhen, China.

Tel: +(86) 0755-82591330 | E-mail: webmaster@lcs-cert.com | Web: www.lcs-cert.com.

Scan code to check authenticity.

**RADIO-FREQUENCY ELECTROMAGNETIC FIELD IMMUNITY TEST RESULTS**

Standard	<input checked="" type="checkbox"/> EN 61547:2009		<input checked="" type="checkbox"/> EN 61000-4-3	
EUT	LED PENDANT	Temperature	22.7°C	
M/N	VT-101-2D	Humidity	52%	
Test Mode	Mode 1	Pressure	1008mbar	
Input voltage	AC 230V,50Hz	Test engineer	Baron.wen	
Modulation	1 kHz, 80 % AM	Test Results	Pass	
Steps	1%			
Angle of EUT	Antenna polarization	Frequency Range	Test Level	Performance Criteria
0°	Vertical Horizontal	80 - 1000 MHz	3 V/m	A
90°	Vertical Horizontal	80 - 1000 MHz	3 V/m	A
180°	Vertical Horizontal	80 - 1000 MHz	3 V/m	A
270°	Vertical Horizontal	80 - 1000 MHz	3 V/m	A

Note :



Shenzhen Southern LCS Compliance Testing Laboratory Ltd.

101-201, No. 39 Building, Xialang Industrial Zone, Heshuikou Community, Matian Street, Guangming District, Shenzhen, China.

Tel: +(86) 0755-82591330 | E-mail: webmaster@lcs-cert.com | Web: www.lcs-cert.com.

Scan code to check authenticity.



ELECTRICAL FAST TRANSIENT/BURST IMMUNITY TEST RESULTS

Standard	<input checked="" type="checkbox"/> EN 61547:2009		<input checked="" type="checkbox"/> EN 61000-4-4	
EUT	LED PENDANT	Temperature	23.9°C	
M/N	VT-101-2D	Humidity	56%	
Test Mode	Mode 1	Pressure	1008mbar	
Input voltage	AC 230V,50Hz	Test Results	Pass	
Test engineer	Zom Zhang			
Port under test	Test Level & polarity	Repetition Frequency	Test duration / polarity	Performance Criteria
AC Input / Output Power	± 1 kV	5 kHz	2min	B
DC Input / Output Power				
Signal / Control Port				

Note:





INJECTED CURRENTS (RADIO-FREQUENCY COMMON MODE) TEST RESULTS

Standard	<input checked="" type="checkbox"/> EN 61547:2009		<input checked="" type="checkbox"/> EN 61000-4-6	
EUT	LED PENDANT	Temperature	23.9°C	
M/N	VT-101-2D	Humidity	56%	
Test Mode	Mode 1	Pressure	1008mbar	
Input voltage	AC 230V,50Hz	Test Results	Pass	
Frequency range	0,15 - 80 MHz	Test engineer	Zom Zhang	
Port under test	Test Level	Coupling method	Dwell time	Performance Criteria
AC Input / Output Power	3 V	CDN	3 seconds	A
DC Input / Output Power				
Signal / Control Port				

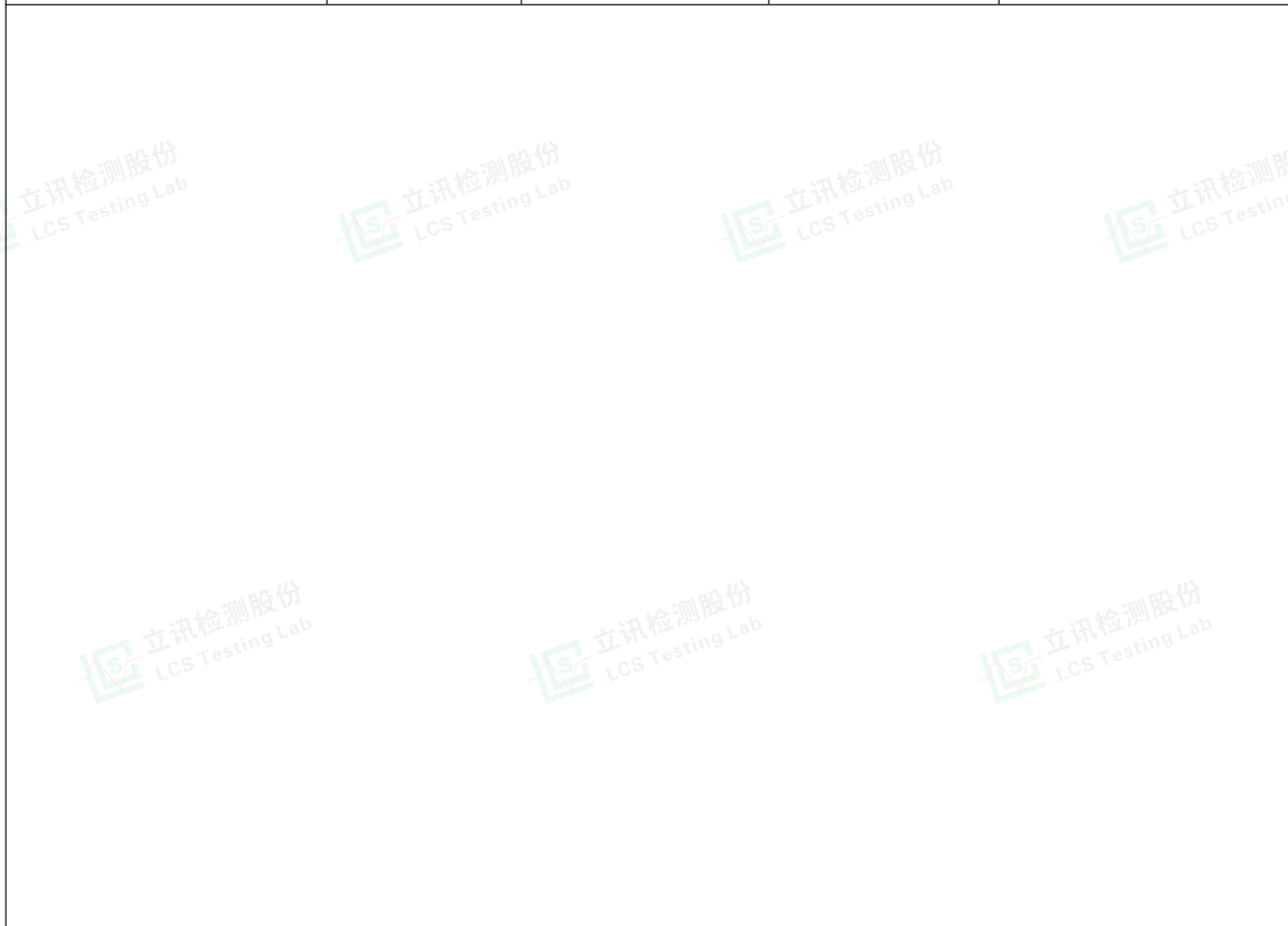

**SURGE IMMUNITY TEST RESULTS**

Standard	<input checked="" type="checkbox"/> EN 61547:2009		<input checked="" type="checkbox"/> EN 61000-4-5			
EUT	LED PENDANT		Temperature	23.9°C		
M/N	VT-101-2D		Humidity	56%		
Test Mode	Mode 1		Pressure	1008mbar		
Input voltage	AC 230V,50Hz		Test Results	Pass		
Test engineer	Zom Zhang					
Port under test	Coupling	Test Level & polarity(kV)	Phase angle (°)	Number of surges	Repetition rate(s)	Performance criteria
AC Input power	L - N	+ 1	90	5	60	C
		- 1	270	5	60	C
AC Input power	L - PE	+ 2	90	5	60	C
		- 2	270	5	60	C
AC Input power	N - PE	+ 2	90	5	60	C
		- 2	270	5	60	C
AC Input power	L&N - PE	+ 2	90	5	60	C
		- 2	270	5	60	C

Note:



Shenzhen Southern LCS Compliance Testing Laboratory Ltd.

101-201, No. 39 Building, Xialang Industrial Zone, Heshuikou Community, Matian Street, Guangming District, Shenzhen, China.

Tel: +(86) 0755-82591330 | E-mail: webmaster@lcs-cert.com | Web: www.lcs-cert.com.

Scan code to check authenticity.



VOLTAGE DIPS AND SHORT INTERRUPTIONS IMMUNITY TEST RESULTS

Standard	<input checked="" type="checkbox"/> EN 61547:2009		<input checked="" type="checkbox"/> EN 61000-4-11		
EUT	LED PENDANT		Temperature	23.9°C	
M/N	VT-101-2D		Humidity	56%	
Test Mode	Mode 1		Pressure	1008mbar	
Input voltage	AC 230V,50Hz		Test Results	Pass	
Test engineer	Zom Zhang				
U _{NOM} (Vac)	Test Level (% U _{NOM})	Number of periods		Phase angle (°)	Performance criteria
		50Hz	60Hz		
230	70	10	12	0, 90, 180, 270	C
230	0	0,5	0,5	0	B

Note:



ANNEX B - TEST PHOTOS

B.1. Conducted Disturbance at electric power supply

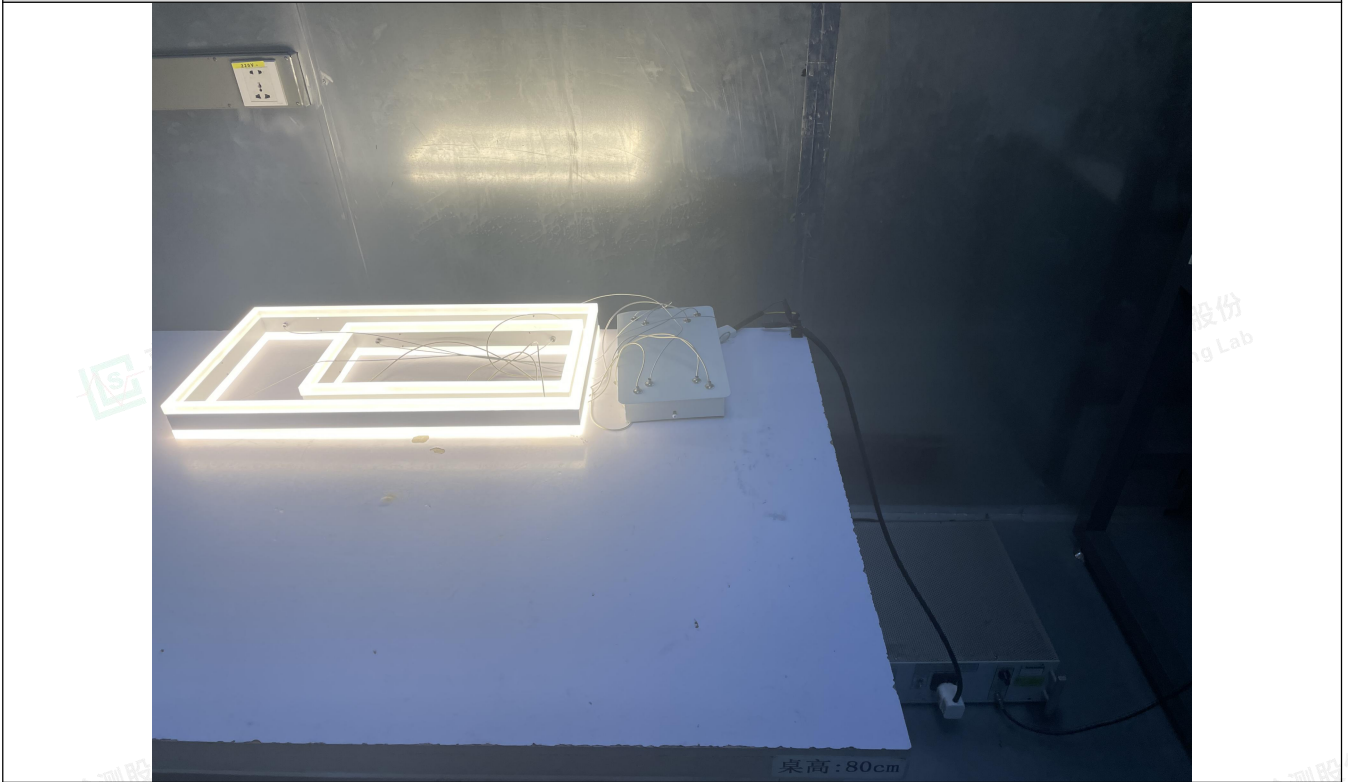

B.2. Radiated Disturbance (9kHz - 30MHz)

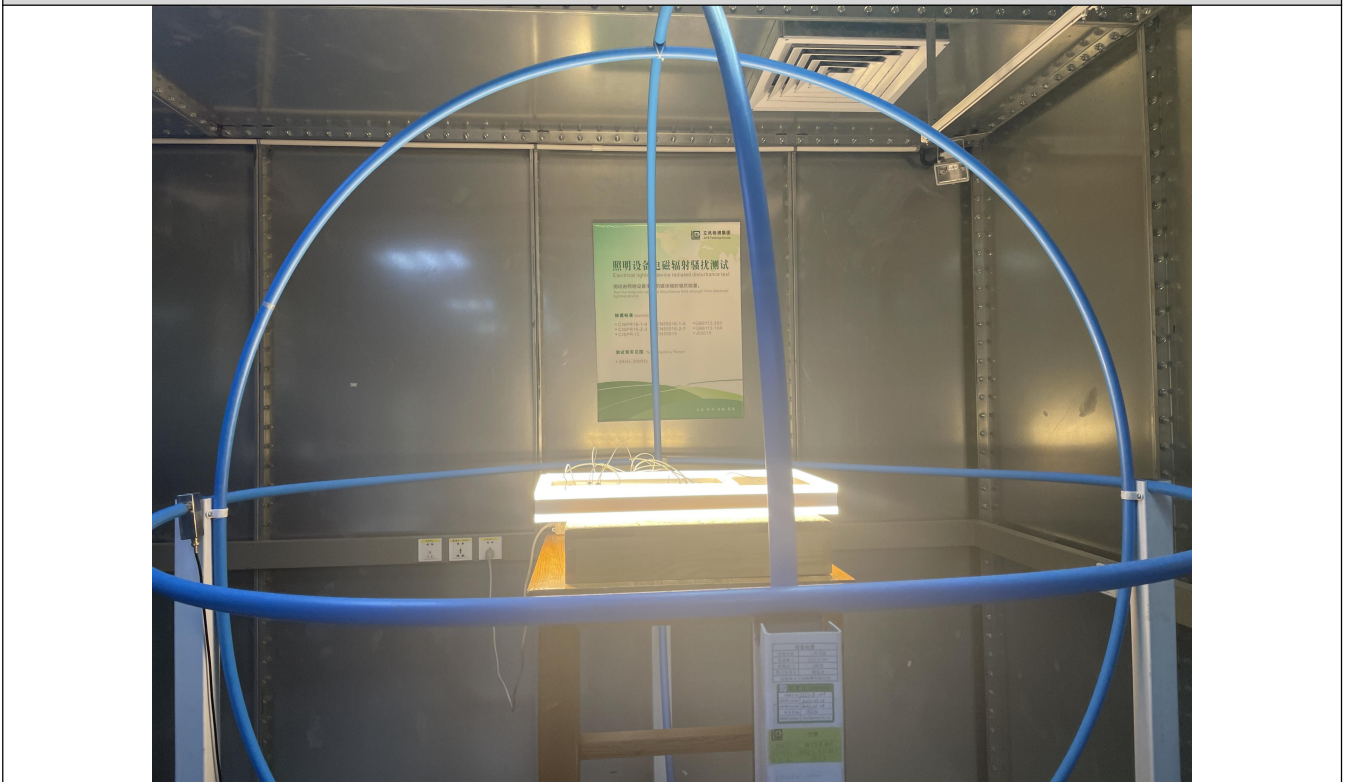

B.3. Radiated Disturbance (30MHz to 1GHz)

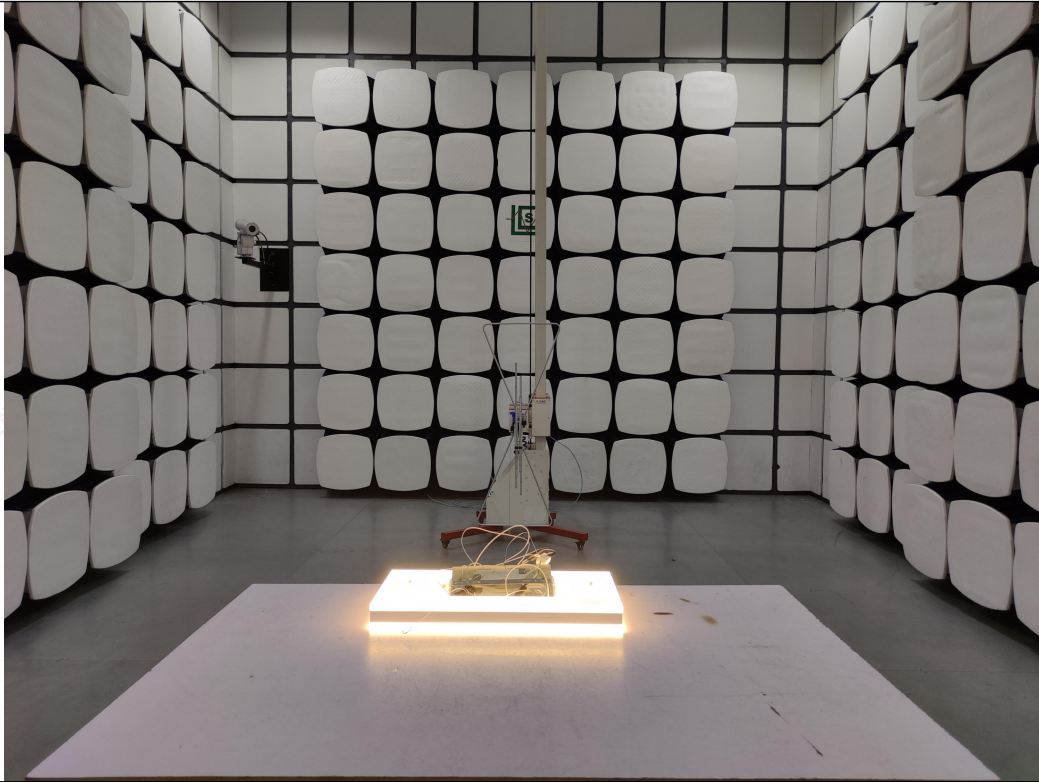

B.4. Harmonic Current

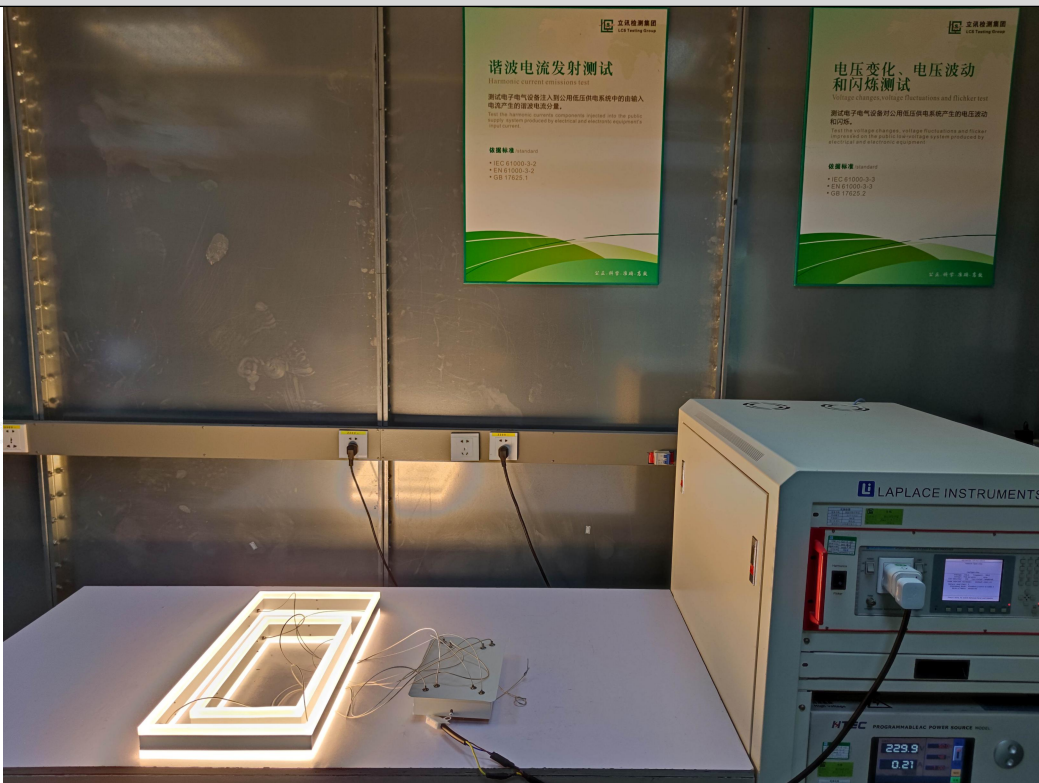



B.5. Electrostatic Discharge



B.6. Electrical Fast Transient / Burst

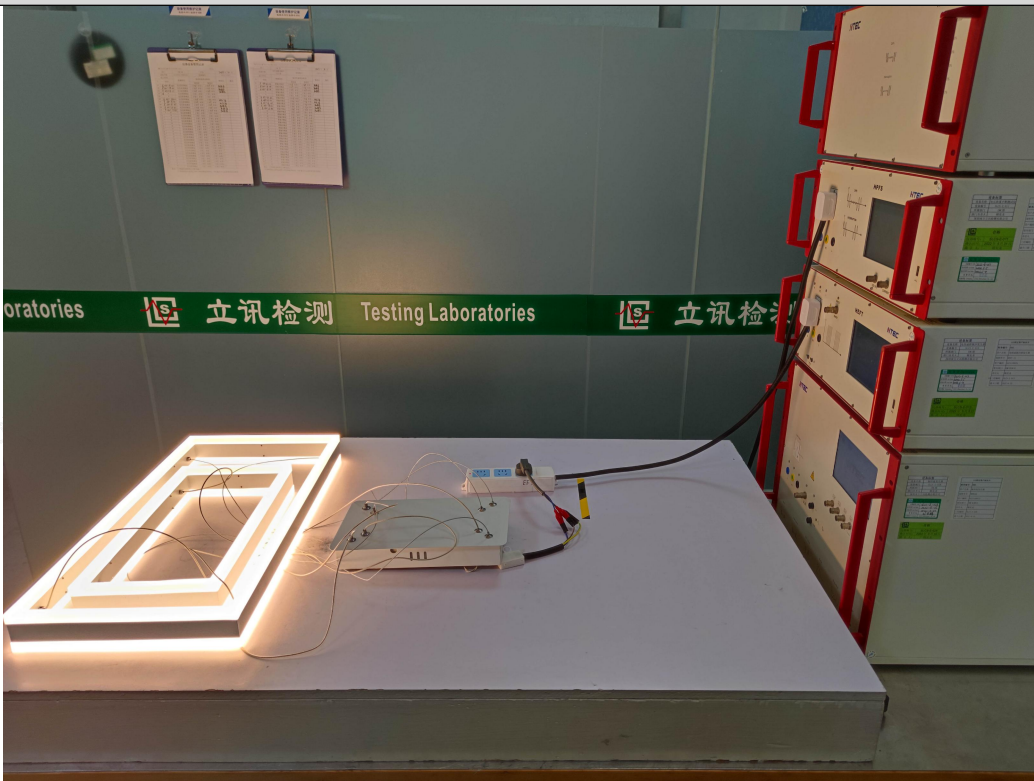

B.7. Injected Currents (Radio-Frequency Common Mode)

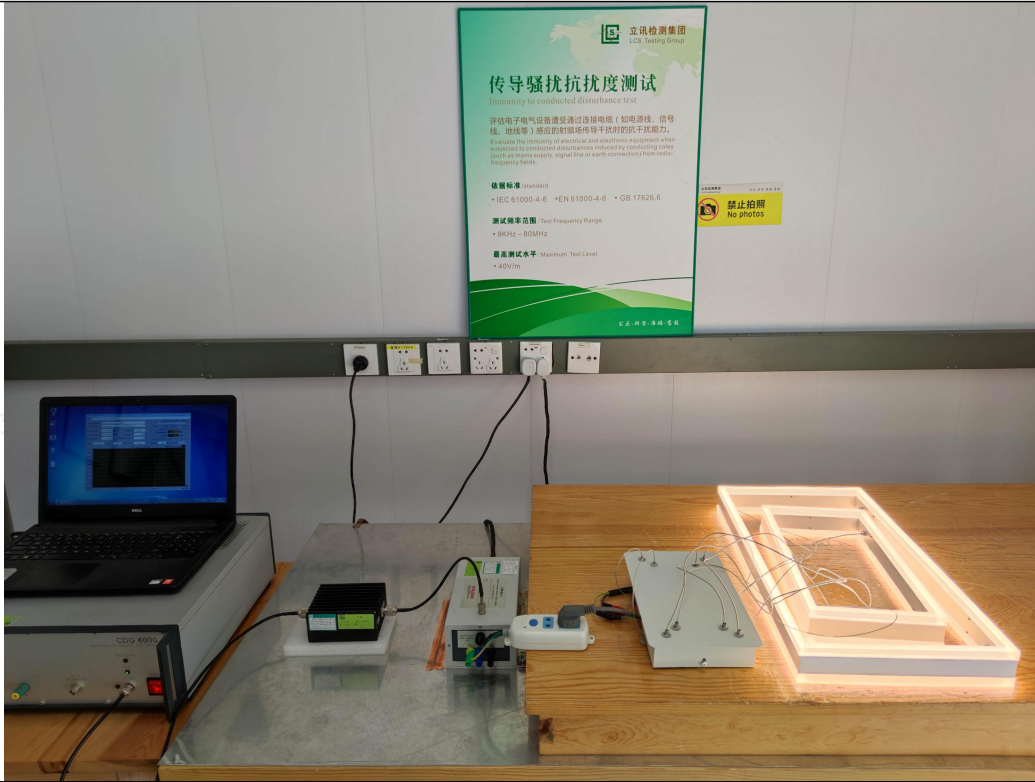

B.8. Surge

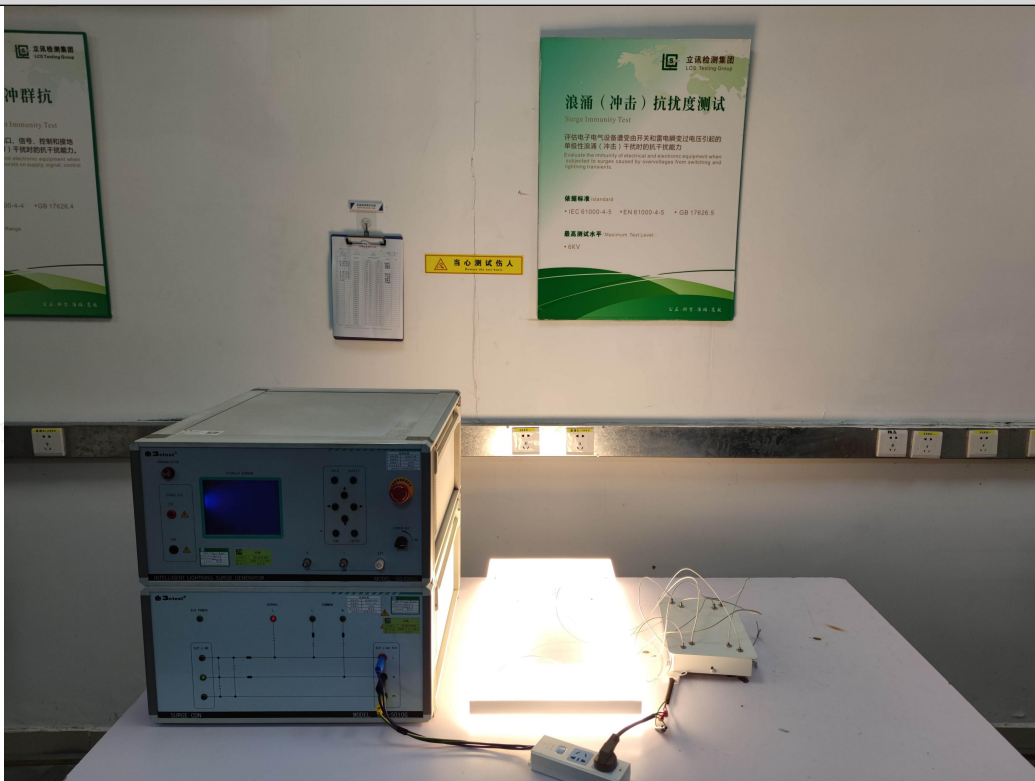



B.9. Voltage Dips and Short Interruptions

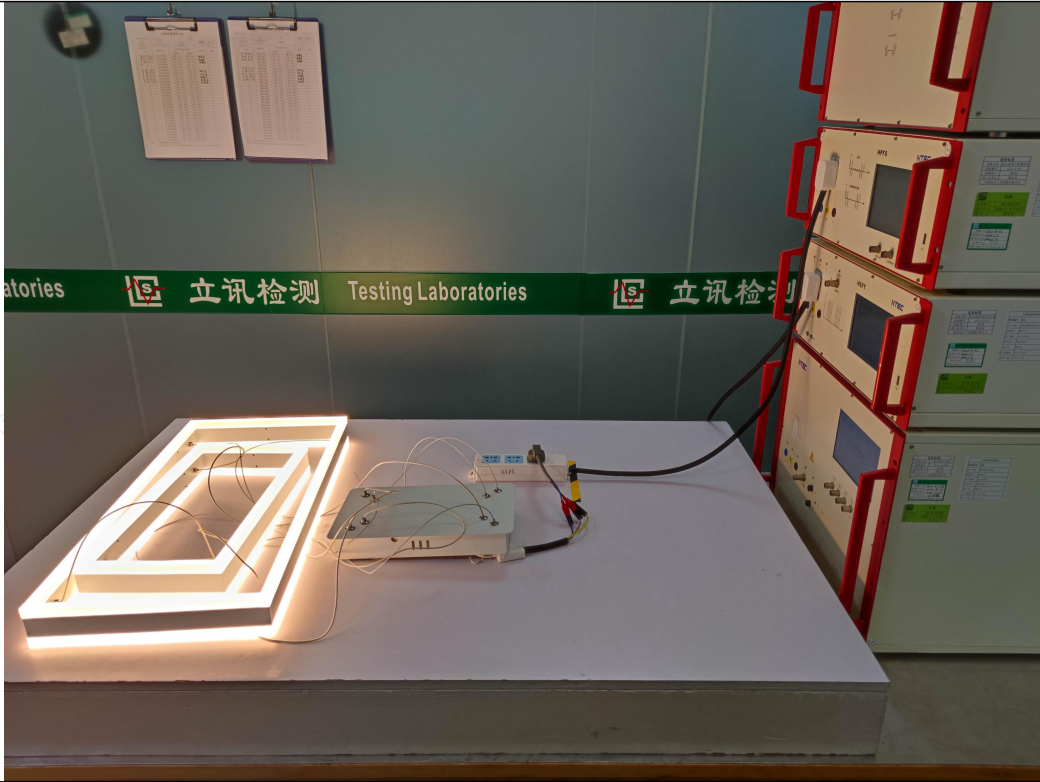

立讯检测股份
LCS Testing Lab

立讯检测股份
LCS Testing Lab

立讯检测股份
LCS Testing Lab

立讯检测股份
LCS Testing Lab

立讯检测股份
LCS Testing Lab

立讯检测股份
LCS Testing Lab

立讯检测股份
LCS Testing Lab



ANNEX C - EXTERNAL AND INTERNAL PHOTOS OF THE EUT

The photographs show the equipment under test.

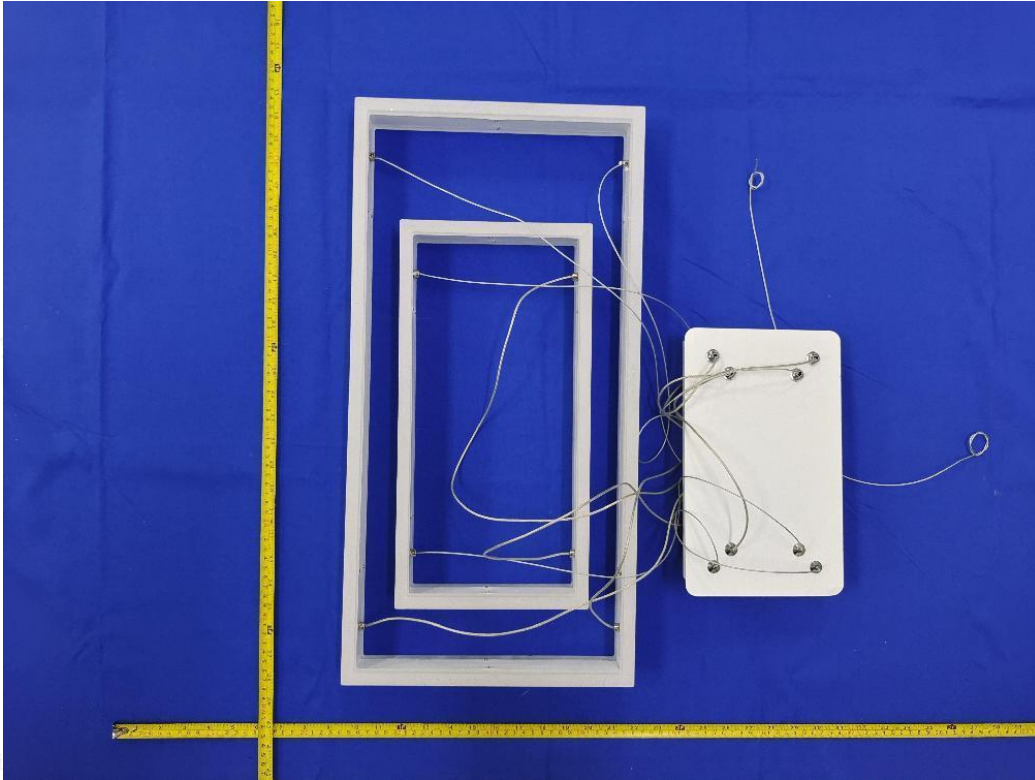

Figure. 1 (VT-101-2D)

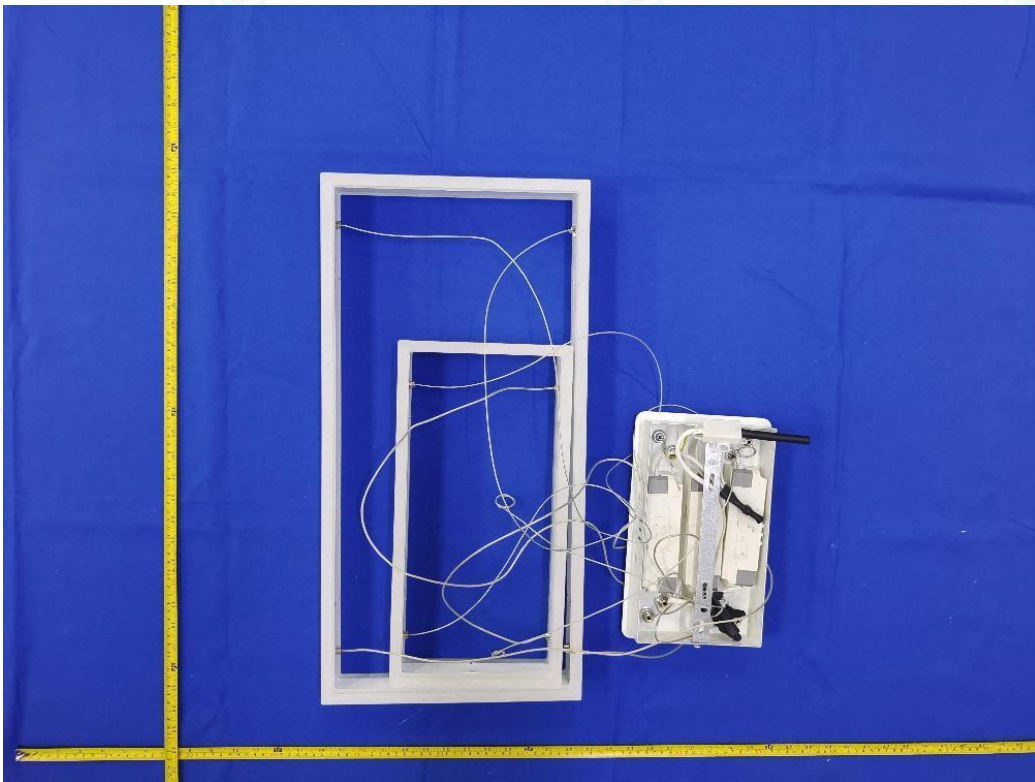

Figure. 2 (VT-101-2D)



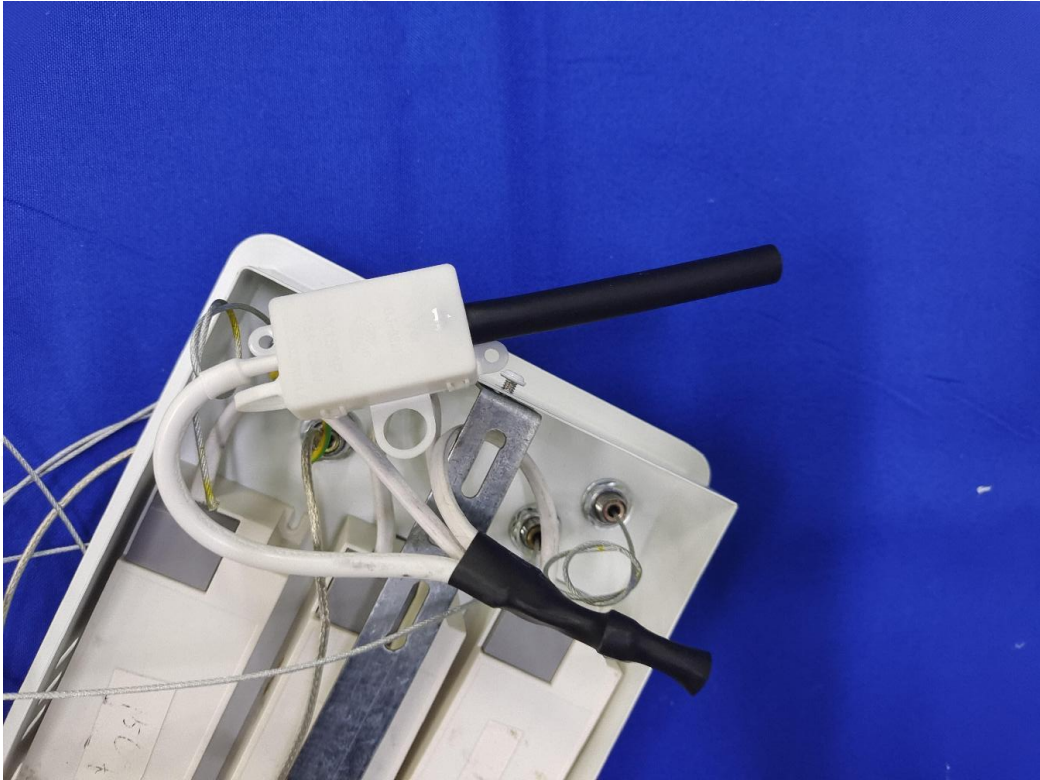

Figure. 3

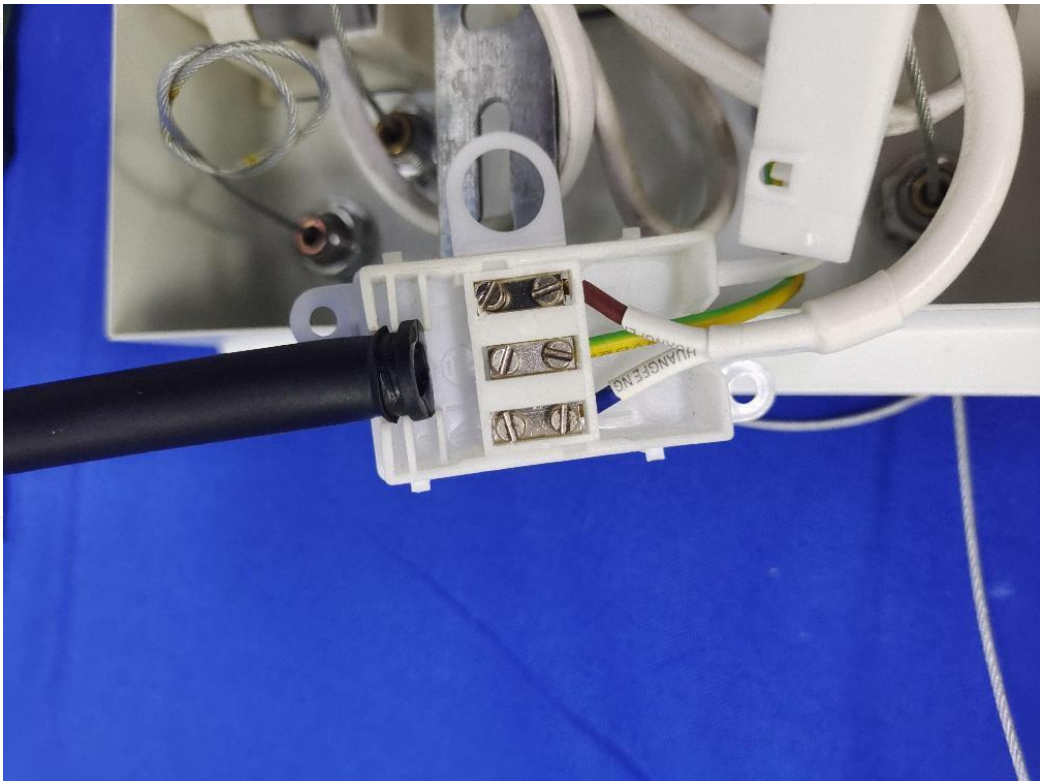

Figure. 4





Figure. 5

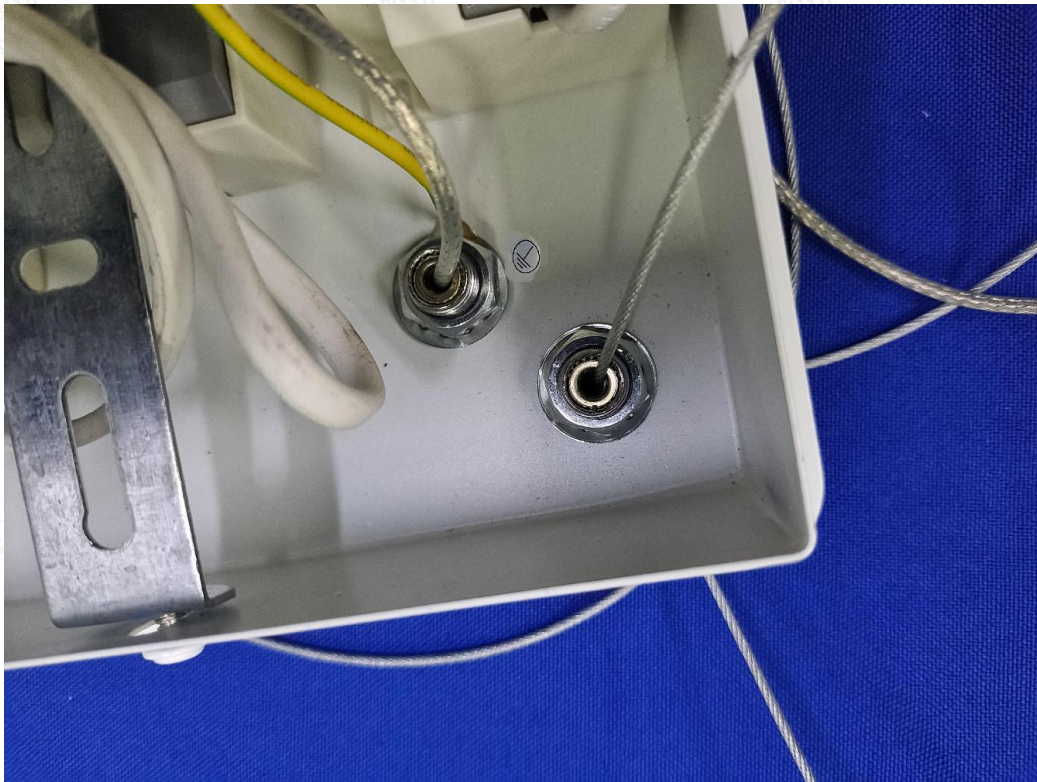

Figure. 6



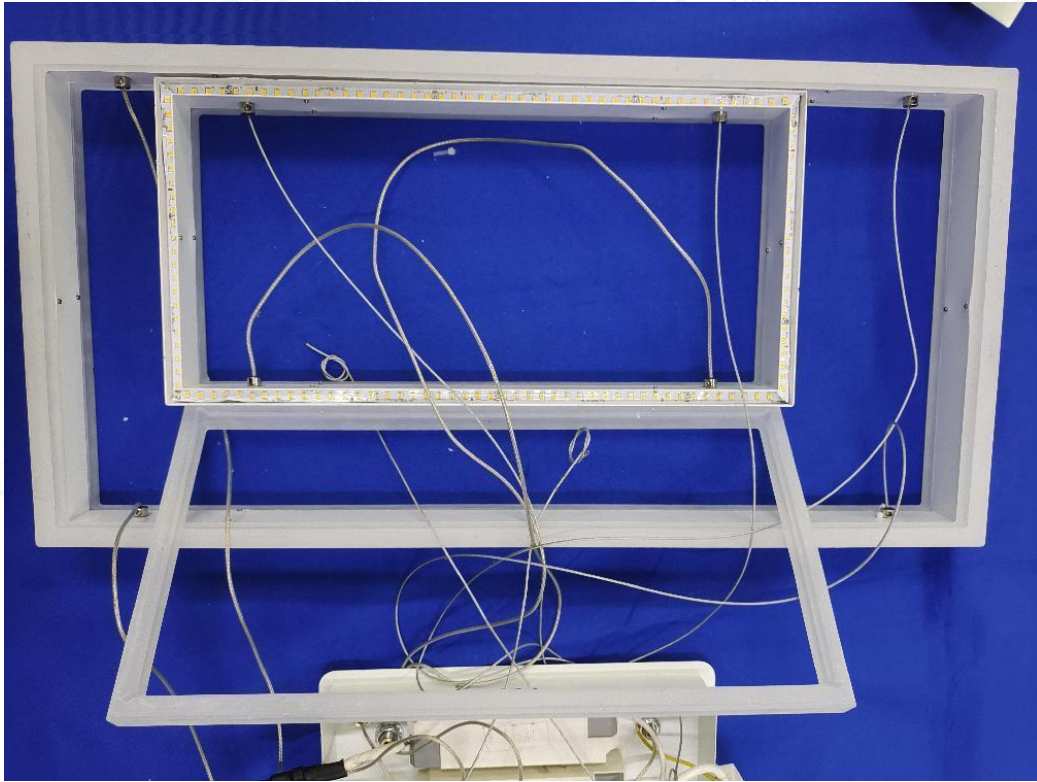

Figure. 7

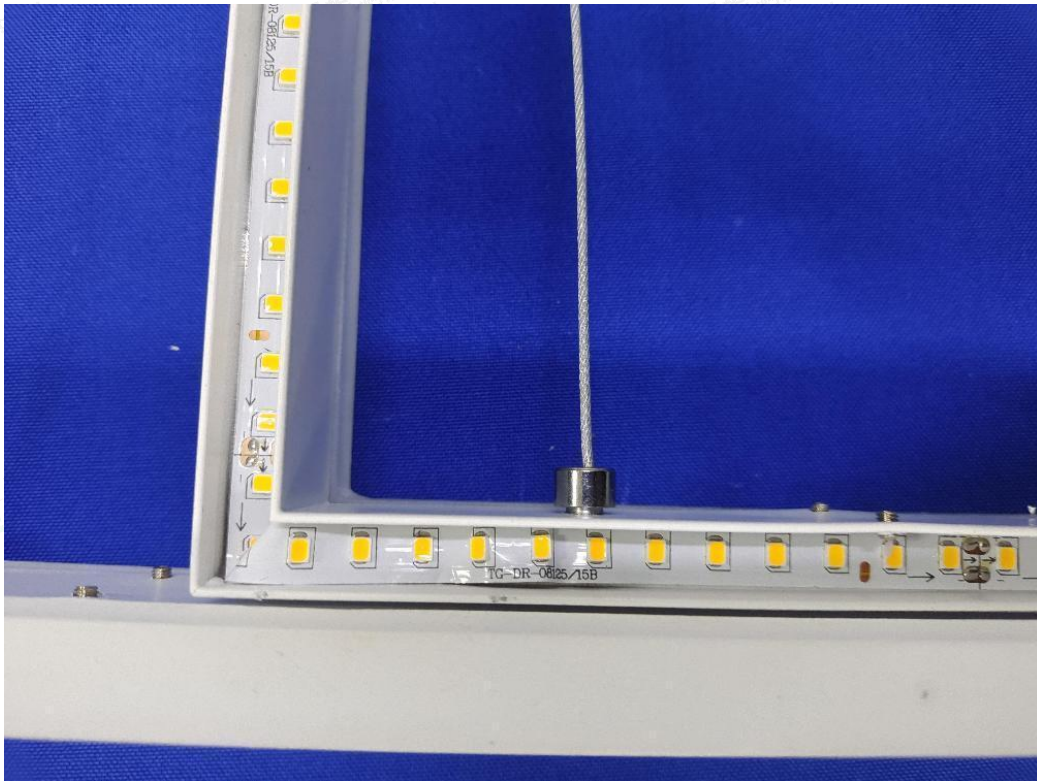

Figure. 8



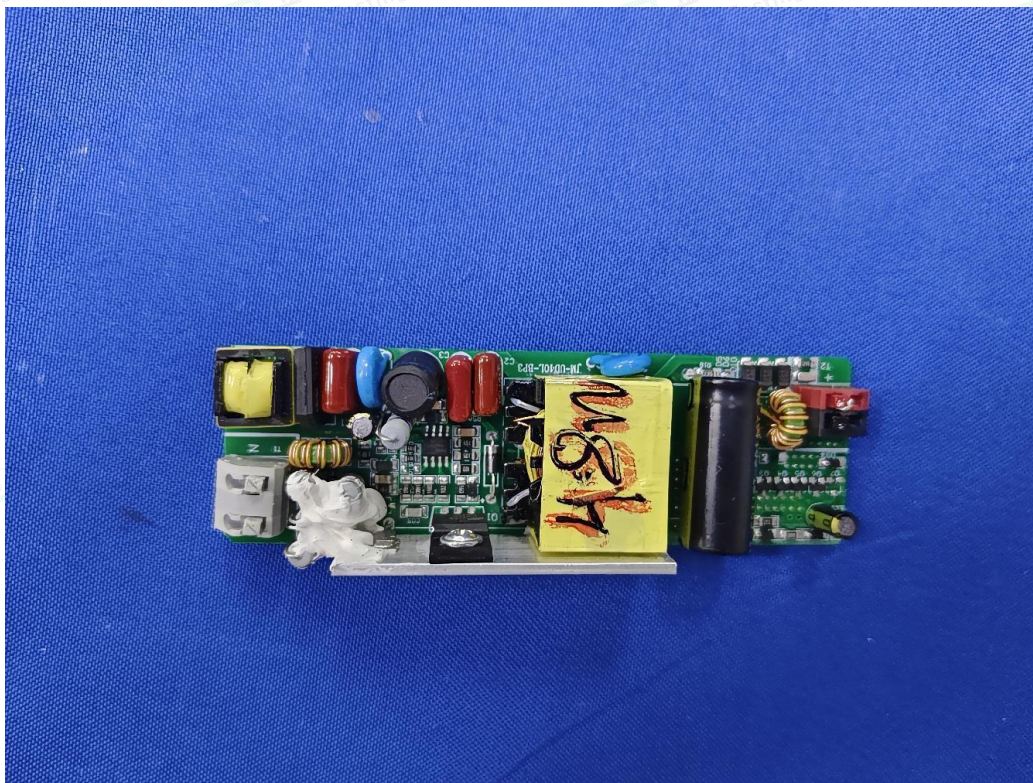

Figure. 9

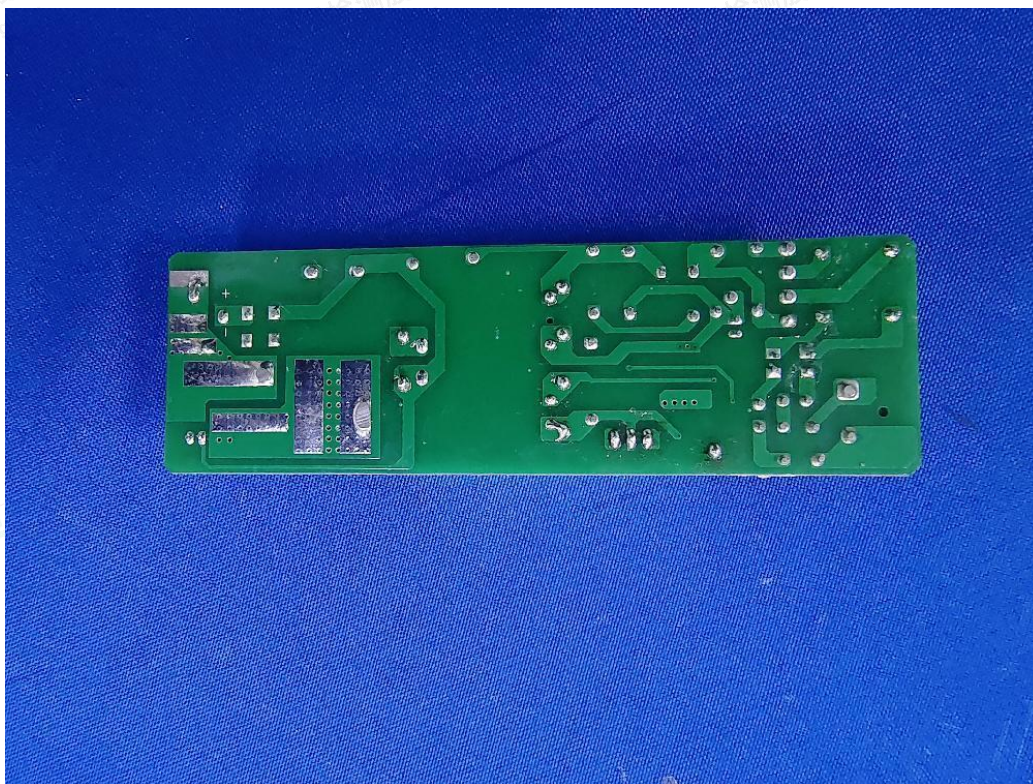

Figure. 10

----- END -----

