



# CE EMC TEST REPORT

For  
TRACK ACCESSORIES

**Model No.:** 3559, 3560, 3529, 9945, 9944, 3633, 3634, 3635, 3636, 3637, 3638, 3639, 3522, 3523, 3524, 3525, 3526, 3527, 3528, 3565, 3566, 9952, 9953, 9954, 9955, 3661, 3662, 3515, 3516, 3519, 3520, 3557, 3558

**Applicant :** V-TAC EXPORTS LIMITED  
ROOM NO.301, KAM ON BUILDING 176A QUEENS ROAD CENTRAL,  
CENTRAL, HONGKONG

**Manufacturer :** V-TAC EXPORTS LIMITED  
ROOM NO.301, KAM ON BUILDING 176A QUEENS ROAD CENTRAL,  
CENTRAL, HONGKONG

**Issued By :** Global-Standard Testing Service Co., Ltd.  
Room 1911, 915 Noble Plaza, Qian Jin 1st Road  
Bao An district, Shenzhen, Guangdong, China.

**Tel :** +86 755 33863599 \*

**Email :** [market@gstslab.com](mailto:market@gstslab.com)

**Report Number :** D00.06.0422E

**Issued Date :** December 26, 2016

**Date of Report :** December 26, 2016

**Note:**

1. The test data and result is based on the tested sample only.
2. Please verify information in the report on GST web: [www.gstslab.com](http://www.gstslab.com) through report number.
3. All rights reserve, the pirate edition investigates necessarily! This report shall not be reproduced unless under the authority of Global-Standard Testing Service Co., Ltd.

## TABLE OF CONTENTS

|   |           |
|---|-----------|
| <b>1. TEST CERTIFICATION .....</b>                                | <b>4</b>  |
| <b>2. TEST RESULT SUMMARY .....</b>                               | <b>5</b>  |
| <b>3. EUT DESCRIPTION .....</b>                                   | <b>6</b>  |
| <b>4. TEST INSTRUMENTS .....</b>                                  | <b>7</b>  |
| <b>5. TEST METHODOLOGY .....</b>                                  | <b>8</b>  |
| 5.1. DECISION OF FINAL TEST MODE .....                            | 8         |
| 5.2. EUT SYSTEM OPERATION .....                                   | 8         |
| <b>6. SETUP OF EQUIPMENT UNDER TEST .....</b>                     | <b>9</b>  |
| 6.1. DESCRIPTION OF SUPPORT UNITS.....                            | 9         |
| 6.2. CONFIGURATION OF SYSTEM UNDER TEST .....                     | 9         |
| <b>7. FACILITIES AND ACCREDITATIONS .....</b>                     | <b>10</b> |
| 7.1. FACILITIES .....   | 10        |
| 7.2. ACCREDITATIONS .....   | 10        |
| 7.3. MEASUREMENT UNCERTAINTY .....                                | 10        |
| <b>8. EMISSION TEST .....</b>                                     | <b>11</b> |
| 8.1. CONDUCTED EMISSION MEASUREMENT .....                         | 11        |
| 8.1.1. LIMITS .....   | 11        |
| 8.1.2. TEST PROCEDURES .....                                      | 11        |
| 8.1.3. TEST SETUP .....   | 12        |
| 8.1.4. TEST RESULTS .....   | 12        |
| 8.2. RADIATED ELECTROMAGNETIC DISTURBANCE .....                   | 15        |
| 8.2.1. LIMITS .....   | 15        |
| 8.2.2. TEST PROCEDURE.....  | 15        |
| 8.2.3. TEST SETUP .....   | 16        |
| 8.2.4. TEST RESULTS .....   | 16        |
| 8.3. RADIATED EMISSION MEASUREMENT .....                          | 20        |
| 8.3.1. LIMITS .....   | 20        |
| 8.3.2. TEST PROCEDURE.....  | 20        |
| 8.3.3. TEST SETUP .....   | 21        |
| 8.3.4. TEST RESULTS .....   | 21        |
| 8.4. HARMONICS CURRENT MEASUREMENT .....                          | 24        |
| 8.4.1. LIMITS OF HARMONICS CURRENT MEASUREMENT .....              | 24        |
| 8.4.2. TEST PROCEDURE.....  | 24        |
| 8.4.3. TEST SETUP .....   | 25        |
| 8.4.4. TEST RESULTS .....   | 25        |
| 8.5. VOLTAGE FLUCTUATION AND FLICKS MEASUREMENT .....             | 32        |
| 8.5.1. LIMITS OF VOLTAGE FLUCTUATION AND FLICKS MEASUREMENT ..... | 32        |
| 8.5.2. TEST PROCEDURE.....  | 32        |
| 8.5.3. TEST SETUP .....   | 32        |
| 8.5.4. TEST RESULTS .....   | 33        |

|  |            |
|--|------------|
| <b>9. IMMUNITY TEST .....</b>                                    | <b>34</b>  |
| 9.1. GENERAL DESCRIPTION .....                                   | 34         |
| 9.2. GENERAL PERFORMANCE CRITERIA DESCRIPTION .....              | 35         |
| 9.3. ELECTROSTATIC DISCHARGE (ESD) .....                         | 35         |
| 9.3.1. TEST SPECIFICATION .....                                  | 35         |
| 9.3.2. TEST PROCEDURE.....                                       | 36         |
| 9.3.3. TEST SETUP .....  | 37         |
| 9.3.4. TEST RESULTS .....  | 38         |
| 9.4. RADIATED, RADIO-FREQUENCY, ELECTROMAGNETIC FIELD (RS) ..... | 39         |
| 9.4.1. TEST SPECIFICATION .....                                  | 39         |
| 9.4.2. TEST PROCEDURE.....                                       | 39         |
| 9.4.3. TEST SETUP .....  | 40         |
| 9.4.4. TEST RESULTS .....  | 41         |
| 9.5. ELECTRICAL FAST TRANSIENT (EFT) .....                       | 42         |
| 9.5.1. TEST SPECIFICATION .....                                  | 42         |
| 9.5.2. TEST PROCEDURE.....                                       | 42         |
| 9.5.3. TEST SETUP .....  | 43         |
| 9.5.4. TEST RESULTS .....  | 44         |
| 9.6. SURGE IMMUNITY TEST .....                                   | 45         |
| 9.6.1 TEST SPECIFICATION .....                                   | 45         |
| 9.6.2. TEST PROCEDURE.....                                       | 45         |
| 9.6.3. TEST SETUP .....  | 46         |
| 9.6.4. TEST RESULTS .....  | 46         |
| 9.7. CONDUCTED RADIO FREQUENCY DISTURBANCES (CS).....            | 47         |
| 9.7.1. TEST SPECIFICATION .....                                  | 47         |
| 9.7.2. TEST PROCEDURE.....                                       | 47         |
| 9.7.3. TEST SETUP .....  | 48         |
| 9.7.4. TEST RESULTS .....  | 48         |
| 9.8. POWER FREQUENCY MAGNETIC FIELD .....                        | 49         |
| 9.8.1. TEST SPECIFICATION .....                                  | 49         |
| 9.8.2. TEST PROCEDURE.....                                       | 49         |
| 9.8.3. TEST SETUP .....  | 50         |
| 9.8.4. TEST RESULTS .....  | 51         |
| 9.9. VOLTAGE DIP & VOLTAGE INTERRUPTIONS.....                    | 51         |
| 9.9.1. TEST SPECIFICATION .....                                  | 51         |
| 9.9.2. TEST PROCEDURE.....                                       | 52         |
| 9.9.3. TEST SETUP .....  | 52         |
| 9.9.4. TEST RESULTS .....  | 53         |
| <b>10. TEST SETUP PHOTOGRAPHS.....</b>                           | <b>54</b>  |
| <b>11. PHOTOGRAPHS OF EUT .....</b>                              | <b>555</b> |

# 1. TEST CERTIFICATION

|                              |  |
|------------------------------|--|
| <b>Product:</b>              | <b>TRACK ACCESSORIES</b>   |
| <b>Model:</b>                | 3559, 3560, 3529, 9945, 9944, 3633, 3634, 3635, 3636, 3637, 3638, 3639, 3522, 3523, 3524, 3525, 3526, 3527, 3528, 3565, 3566, 9952, 9953, 9954, 9955, 3661, 3662, 3515, 3516, 3519, 3520, 3557, 3558 |
| <b>Applicant:</b>            | V-TAC EXPORTS LIMITED<br>ROOM NO.301, KAM ON BUILDING 176A QUEENS ROAD CENTRAL, CENTRAL, HONGKONG  |
| <b>Factory:</b>              | V-TAC EXPORTS LIMITED<br>ROOM NO.301, KAM ON BUILDING 176A QUEENS ROAD CENTRAL, CENTRAL, HONGKONG  |
| <b>Test Voltage:</b>         | AC 230V/50Hz   |
| <b>Applicable Standards:</b> | <b>EN 55015: 2013+A1:2015</b><br><b>EN 61547: 2009</b><br><b>EN 61000-3-2:2014</b><br><b>EN 61000-3-3: 2013</b>  |

| Deviation from Applicable Standard |
|------------------------------------|
| None                               |

The above equipment has been tested by Global-Standard Testing Service Co., Ltd. and found compliance with the requirements set forth in the technical standards mentioned above. The results of testing in this report apply only to the product/system, which was tested. Other similar equipment will not necessarily produce the same results due to production tolerance and measurement uncertainties.

|   |   |
|---|---|
| <p><b>Tested By:</b> _____ <i>Jerry Hu</i></p> <p><b>Approved By:</b> _____ <i>APPROVED Tim Sun</i></p> | <p><b>Date:</b> _____ <b>December 22, 2016</b></p> <p><b>Date:</b> _____ <b>December 26, 2016</b></p> |
|---|---|

## 2. TEST RESULT SUMMARY

| EMISSION               |                                      |        |            |
|------------------------|--------------------------------------|--------|------------|
| Standard               | Item                                 | Result | Remarks    |
| EN 55015: 2013+A1:2015 | Conducted (Main Port)                | PASS   | Meet limit |
|                        | Radiated Electromagnetic Disturbance | PASS   | Meet limit |
|                        | Radiated                             | PASS   | Meet limit |
| EN 61000-3-2:2014      | Harmonic current emissions           | PASS   | Meet limit |
| EN 61000-3-3:2013      | Voltage fluctuations & flicker       | PASS   | Meet limit |

| IMMUNITY 【EN 61547:2009】          |                                   |        |   |
|-----------------------------------|-----------------------------------|--------|---|
| Standard                          | Item                              | Result | Remarks   |
| EN 61000-4-2:2009                 | ESD                               | PASS   | Meets the requirements of Performance Criterion B   |
| EN 61000-4-3:2006+A1:2008+A2:2010 | RS                                | PASS   | Meets the requirements of Performance Criterion A   |
| EN 61000-4-4:2012                 | EFT                               | PASS   | Meets the requirements of Performance Criterion B   |
| EN 61000-4-5:2014                 | Surge                             | PASS   | Meets the requirements of Performance Criterion B   |
| EN 61000-4-6:2014                 | CS                                | PASS   | Meets the requirements of Performance Criterion A   |
| EN 61000-4-8:2010                 | PFMF                              | PASS   | Meets the requirements  |
| EN 61000-4-11:2004                | Voltage dips & voltage variations | PASS   | Meets the requirements of <b>Voltage dips and variations</b><br>1) 30% reduction performance Criterion C<br>2) 100% reduction performance Criterion B |

- Note:**
1. The test result judgment is decided by the limit of test standard
  2. The information of measurement uncertainty is available upon the customer's request.

### 3. EUT DESCRIPTION

|                         |   |
|-------------------------|---|
| <b>Product</b>          | <b>TRACK ACCESSORIES</b>  |
| <b>Model</b>            | 9945  |
| <b>Applicant</b>        | V-TAC EXPORTS LIMITED   |
| <b>Housing material</b> | Plastic & Metal   |
| <b>EUT Type</b>         | <input checked="" type="checkbox"/> Engineering Sample. <input type="checkbox"/> Product Sample,<br><input type="checkbox"/> Mass Product Sample. |
| <b>Serial Number</b>    | N/A   |
| <b>EUT Power Rating</b> | AC 200-240V, 50/60Hz, 200W Max  |
| <b>AC Line</b>          | N/A   |

## 4. TEST INSTRUMENTS

| Immunity shielded room         |                        |                  |               |                 |
|--------------------------------|------------------------|------------------|---------------|-----------------|
| Name of Equipment              | Manufacturer           | Model            | Serial Number | Calibration Due |
| EMC PARTNER TRANSIENT 2000     | EMC PARTNER            | TRA2000          | 881           | 09/27/2017      |
| Power-frequency Magnetic field | SCHAFFNER              | CCN 1000-1       | 72046         | 09/27/2017      |
| Induction Coil Interface       | SCHAFFNER              | INA2141          | 6003          | 09/27/2017      |
| Signal Generator               | Maconi                 | 2022D            | 119246/003    | 09/27/2017      |
| Power Amplifier                | M2S                    | A00181-1000      | 9801-112      | 09/27/2017      |
| CDN                            | MEB                    | M3-8016          | 003683        | 09/27/2017      |
| Power Amplifier                | M2S                    | AC8113/ 800-250A | 9801-179      | 09/27/2017      |
| Power Antenna                  | SCHAFFNER              | CBL6140A         | 1204          | 09/27/2017      |
| ESD 2000                       | EMC PARTNER            | ESD2000          | 182           | 09/27/2017      |
| Harmonic & Flicker Tester      | California instruments | PACS-3           | SB2588/01     | 09/27/2017      |
| AC Power Source                | California instruments | 5001iX-CTS-40    | SB2588        | 09/27/2017      |
| EMI Test Receiver              | R&S                    | ESCI             | 100005        | 09/27/2017      |
| Spectrum Analyzer              | R&S                    | FSU              | 100114        | 09/27/2017      |
| Pre Amplifier                  | H.P.                   | HP8447E          | 2945A02715    | 09/27/2017      |
| Bilog Antenna                  | SUNOL Sciences         | JB3              | A021907       | 09/27/2017      |
| Cable                          | TIME MICROWAVE         | LMR-400          | N-TYPE04      | 09/27/2017      |
| System-Controller              | CCS                    | N/A              | N/A           | N.C.R           |
| Turn Table                     | CCS                    | N/A              | N/A           | N.C.R           |
| Antenna Tower                  | CCS                    | N/A              | N/A           | N.C.R           |
| Triple-Loop Antenna            | EVERFINE               | LLA-2            | N/A           | 09/27/2017      |
| LISN                           | AFJ                    | LS16             | 16010222119   | 09/27/2017      |
| LISN(EUT)                      | Mestec                 | AN3016           | 04/10040      | 09/27/2017      |

**NOTE:**

- (1) The calibration interval of the above test instruments is 12 months and the calibrations are traceable to international system unit (SI).
- (2). N.C.R = No Calibration Request.

## 5. TEST METHODOLOGY

### 5.1. DECISION OF FINAL TEST MODE

The EUT was tested together with the thereafter additional components, and a configuration, which produced the worst emission levels, was selected and recorded in this report.

The following test mode(s) were scanned during the preliminary test:

| Pre-Test Mode |                                      |                        |
|---------------|--------------------------------------|------------------------|
| Emission      | Conducted Emission                   | Mode: Normal Operating |
|               | Radiated Electromagnetic Disturbance | Mode: Normal Operating |
|               | Radiated Emission                    | Mode: Normal Operating |
| Immunity      |                                      | Mode: Normal Operating |

After the preliminary scan, the following test mode was found to produce the highest emission level.

| Pre-Test Mode |                                      |                        |
|---------------|--------------------------------------|------------------------|
| Emission      | Conducted Emission                   | Mode: Normal Operating |
|               | Radiated Electromagnetic Disturbance | Mode: Normal Operating |
|               | Radiated Emission                    | Mode: Normal Operating |
| Immunity      |                                      | Mode: Normal Operating |

### 5.2. EUT SYSTEM OPERATION

1. Set up EUT with the support equipments.
2. Make sure the EUT work normally during the test.



## 6. SETUP OF EQUIPMENT UNDER TEST

### 6.1. DESCRIPTION OF SUPPORT UNITS

The EUT has been tested as an independent unit together with other necessary accessories or support units. The following support units or accessories were used to form a representative test configuration during the tests.

| No. | Equipment | Model No. | Serial No. | FCC ID | Trade Name | Data Cable | Power Cord |
|-----|-----------|-----------|------------|--------|------------|------------|------------|
| 1.  | N/A       | N/A       | N/A        | N/A    | N/A        | N/A        | N/A        |

**Note:**

- 1) All the equipment/cables were placed in the worst-case configuration to maximize the emission during the test.
- 2) Grounding was established in accordance with the manufacturer's requirements and conditions for the intended use.

### 6.2. CONFIGURATION OF SYSTEM UNDER TEST

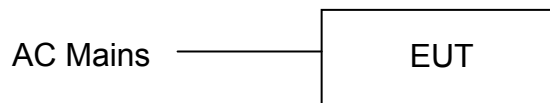

(EUT: TRACK ACCESSORIES)

## 7. FACILITIES AND ACCREDITATIONS

### 7.1. FACILITIES

The sites are constructed in conformance with the requirements of ANSI C63.4 and CISPR Publication 15. All receiving equipment conforms to CISPR Publication 16-1, "Radio Interference Measuring Apparatus and Measurement Methods."

All measurement required was performed at laboratory of SEM Testing Technology Co., Ltd. 1/F, Building A, Hongwei Industrial Park, Liuxian 2nd Road, Bao'an District, Shenzhen, P.R.C.

### 7.2. ACCREDITATIONS

### 7.3. MEASUREMENT UNCERTAINTY

Where relevant, the following measurement uncertainty levels have been estimated for tests performed on the EUT as specified in CISPR 16-4-2:

| Measurement              | Frequency  | Uncertainty     |            |
|--------------------------|------------|-----------------|------------|
| Conducted emissions      | 9kHz~30MHz | +/- 3.59dB      |            |
| Radiated electromagnetic | 9kHz~30MHz | +/- 4.77dB      |            |
| Radiated emissions       | Horizontal | 30MHz ~ 200MHz  | +/- 4.77dB |
|                          |            | 200MHz ~1000MHz | +/- 4.93dB |
|                          | Vertical   | 30MHz ~ 200MHz  | +/- 5.04dB |
|                          |            | 200MHz ~1000MHz | +/- 4.93dB |

This uncertainty represents an expanded uncertainty expressed at approximately the 95% confidence level using a coverage factor of k=2.

## 8. EMISSION TEST

### 8.1. CONDUCTED EMISSION MEASUREMENT

#### 8.1.1. LIMITS

| FREQUENCY (MHz) | LIMITS(dBuV) |         |
|-----------------|--------------|---------|
|                 | Quasi-peak   | Average |
| 0.009-0.05      | 110          | N/A     |
| 0.05-0.15       | 90 – 80      | N/A     |
| 0.15 – 0.5      | 66 – 56      | 56 – 46 |
| 0.50 – 5.0      | 56           | 46      |
| 5.0 – 30.0      | 60           | 50      |

**NOTE:**

- (1) The lower limit shall apply at the transition frequencies.
- (2) The limit decreases in line with the logarithm of the frequency in the range of 0.15 to 0.50 MHz.
- (3) All emanations from EUT or system, shall not exceed the level of field strengths specified above.

#### 8.1.2. TEST PROCEDURES

##### Procedure of Preliminary Test

The EUT and Support equipment, if needed, was set up as per the test configuration to simulate typical usage per the user's manual. When the EUT is a tabletop system, a wooden table with a height of 0.8 meters is used and is placed on the ground plane. When the EUT is a floor standing equipment, it is placed on the ground plane, which has a 3-12 mm non-conductive covering to insulate the EUT from the ground plane.

The EUT test program was started. Emissions were measured on each current carrying line of the EUT using an EMI Test Receiver connected to the LISN powering the EUT. The Receiver scanned from 9 kHz to 30MHz for emissions in each of the test modes. During the above scans, the emissions were maximized by cable manipulation.

The test mode(s) described in Item 3.1 were scanned during the preliminary test.

After the preliminary scan, we found the test mode described in Item 3.1 producing the highest emission level.

The EUT configuration and cable configuration of the above highest emission levels were recorded for reference of the final test.

##### Procedure of Final Test

EUT and support equipment were set up on the test bench as per the configuration with highest emission level in the preliminary test.

A scan was taken on both power lines, Line 1 and Line 2, recording at least the six highest emissions. Emission frequency and amplitude were recorded into a computer in which correction factors were used to calculate the emission level and compare reading to the applicable limit.

The test data of the worst-case condition(s) was recorded.

### 8.1.3. TEST SETUP

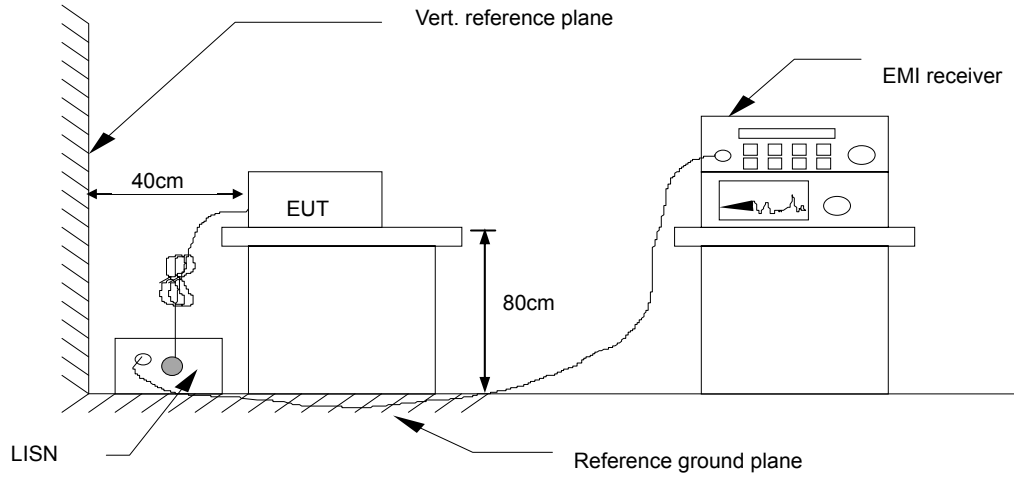

For the actual test configuration, please refer to the related item – Photographs of the Test Configuration.

### 8.1.4. TEST RESULTS

|                              |                   |
|------------------------------|-------------------|
| Temperature ( °C )           | 22~28             |
| Humidity ( %RH )             | 50~58             |
| Barometric Pressure ( mbar ) | 950~1000          |
| EUT                          | TRACK ACCESSORIES |
| M/N                          | 9945              |
| Operating Mode               | Normal Operating  |
| Test Results                 | PASS              |

Please refer to following diagram for individual

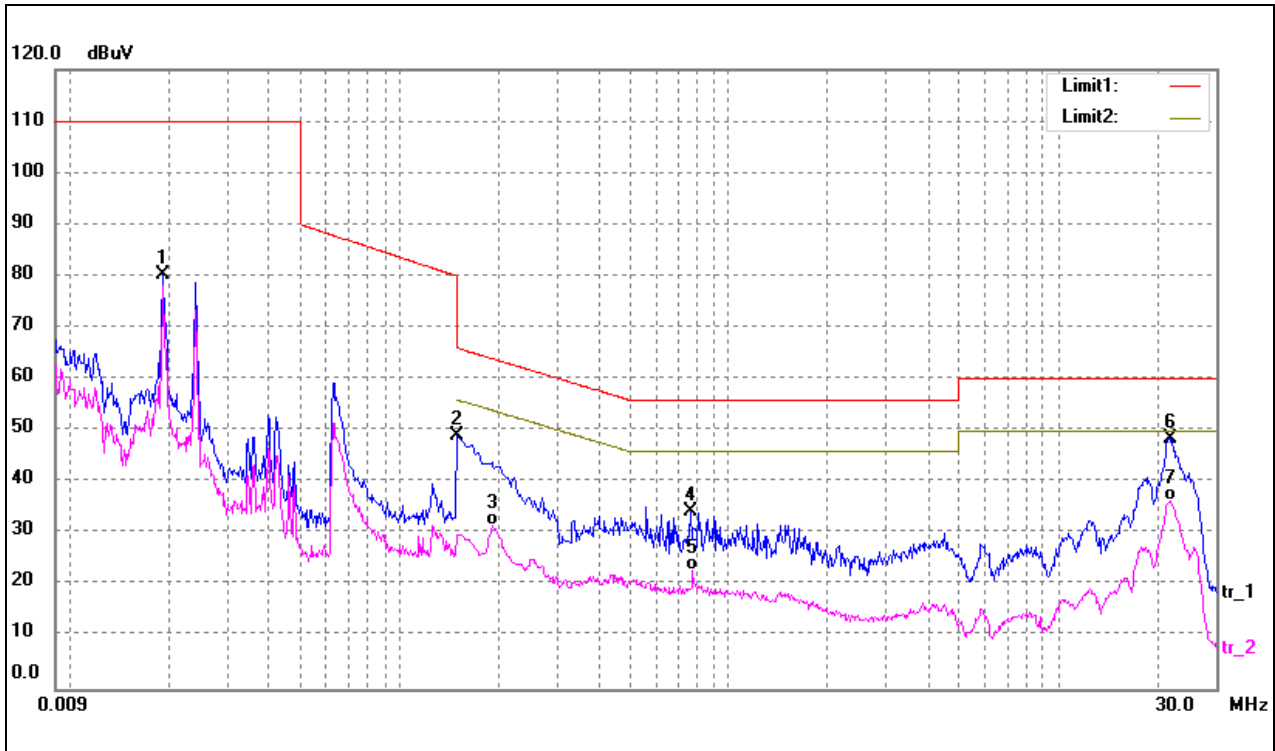

|              |                   |                    |                   |
|--------------|-------------------|--------------------|-------------------|
| EUT:         | TRACK ACCESSORIES | Model Name :       | 9945              |
| Temperature: | 24 °C             | Relative Humidity: | 54%               |
| Pressure:    | 1010 hPa          | Test Date :        | December 22, 2016 |
| Test Mode :  | Normal Operating  | Polarization :     | L                 |
| Test Power : | AC 230V/50Hz      |                    |                   |

| No. | Frequency (MHz) | Reading (dBuV) | Correct (dB/m) | Result (dBuV) | Limit (dBuV) | Margin (dB) | Detector |
|-----|-----------------|----------------|----------------|---------------|--------------|-------------|----------|
| 1   | 0.0191          | 70.52          | 9.85           | 80.37         | 110.00       | -29.63      | peak     |
| 2   | 0.1500          | 39.14          | 9.85           | 48.99         | 66.00        | -17.01      | peak     |
| 3   | 0.1900          | 21.71          | 9.81           | 31.52         | 54.04        | -22.52      | AVG      |
| 4   | 0.7620          | 24.50          | 9.78           | 34.28         | 56.00        | -21.72      | peak     |
| 5   | 0.7780          | 13.19          | 9.78           | 22.97         | 46.00        | -23.03      | AVG      |
| 6*  | 21.7260         | 38.86          | 9.68           | 48.54         | 60.00        | -11.46      | peak     |
| 7   | 21.9340         | 26.84          | 9.68           | 36.52         | 50.00        | -13.48      | AVG      |

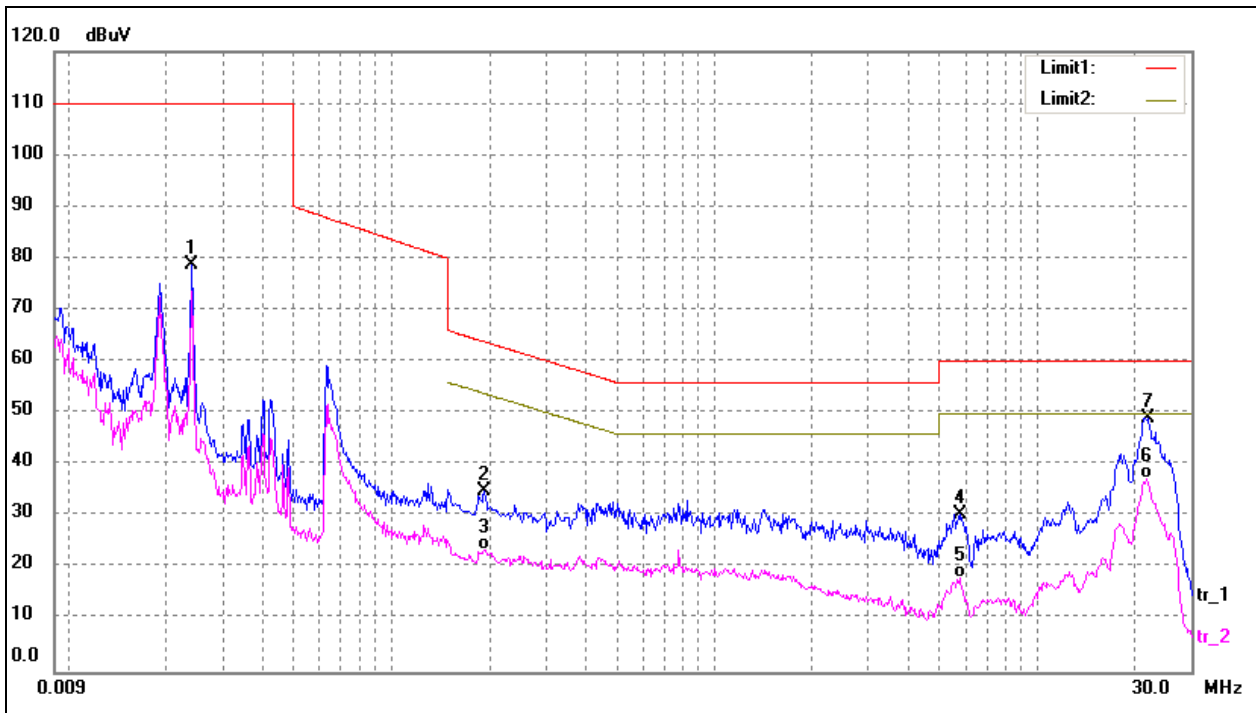

|              |                   |                    |                   |
|--------------|-------------------|--------------------|-------------------|
| EUT:         | TRACK ACCESSORIES | Model Name :       | 9945              |
| Temperature: | 24 °C             | Relative Humidity: | 54%               |
| Pressure:    | 1010 hPa          | Test Date :        | September 28,2016 |
| Test Mode :  | Normal Operating  | Polarization :     | N                 |
| Test Power : | AC 230V/50Hz      |                    |                   |

| No. | Frequency (MHz) | Reading (dBuV) | Correct (dB/m) | Result (dBuV) | Limit (dBuV) | Margin (dB) | Detector |
|-----|-----------------|----------------|----------------|---------------|--------------|-------------|----------|
| 1   | 0.0240          | 68.91          | 9.85           | 78.76         | 110.00       | -31.24      | peak     |
| 2   | 0.1940          | 25.23          | 9.81           | 35.04         | 63.86        | -28.82      | peak     |
| 3   | 0.1940          | 13.84          | 9.81           | 23.65         | 53.86        | -30.21      | AVG      |
| 4   | 5.7700          | 20.90          | 9.64           | 30.54         | 60.00        | -29.46      | peak     |
| 5   | 5.7700          | 8.40           | 9.64           | 18.04         | 50.00        | -31.96      | AVG      |
| 6   | 21.9500         | 27.76          | 9.68           | 37.44         | 50.00        | -12.56      | AVG      |
| 7*  | 22.0980         | 39.40          | 9.68           | 49.08         | 60.00        | -10.92      | peak     |

## 8.2. RADIATED ELECTROMAGNETIC DISTURBANCE

### 8.2.1. LIMITS

| Frequency     | Limits for loop diameter dB(uA)* |          |         |
|---------------|----------------------------------|----------|---------|
|               | 2m                               | 3m       | 4m      |
| 9KHz-70KHz    | 88                               | 81       | 75      |
| 70KHz-150KHz  | 88-58**                          | 81-51**  | 75-45** |
| 150KHz-3.0MHz | 58-22**                          | 51-22**  | 45-16** |
| 3.0MHz-30MHz  | 22                               | 15-16*** | 9-12*** |

\* At the transition frequency, the lower limit applies.

\*\* Decreasing linearly with the logarithm of the frequency.

\*\*\* Increasing linearly with the logarithm of the frequency.

Note: In Japan, the limits for frequencies 9KHz to 150KHz do not apply.

### 8.2.2. TEST PROCEDURE

In the frequency range 9KHz to 30MHz the interference capability of the magnetic field component of the radiation of Equipment Under Test (EUT) can be determined by using a special Loop Antenna System (LAS). In the LAS, this capability is measured in terms of the currents induced by the magnetic field in the loop antennas of the LAS. The LAS allows indoor measurement.

The LAS consists of three circular, mutually perpendicular Large-Loop Antennas (LLAs), having a diameter of 2 m, supported by a non-metallic base. A 50Ω coaxial cable between the current probe of an LLA and the coaxial switch, and between this switch and the measuring equipment, shall have a surface transfer impedance smaller than 10mΩ/m at 100KHz and 1mΩ/m at 10MHz.

The distance between the outer diameter of the loop antenna system and nearby objects, such as floor and walls, shall be at least 0.5m as per CISPR 15/ EN55015.

The EUT is positioned in the center of the LAS (To avoid unwanted capacitive coupling between the EUT and the LAS, the maximum dimensions of the EUT are limited so that the distance between the EUT and an LLA is at least 0.2m). Cables should be routed together and leave the loop volume in the same octant of the cell, no closer than 0.4m to the LAS loops.

The induced current in the loop antenna is measured by means of a current probe(1V/A) and the CISPR measuring receiver(or equivalent). By means of a coaxial switch, the three field direction(X, Y, Z) can be measured in sequence, and recorded at least the six highest emission. Each value shall fulfill the requirement given.

The test data of the worst-case condition(s) was recorded.

### 8.2.3. TEST SETUP

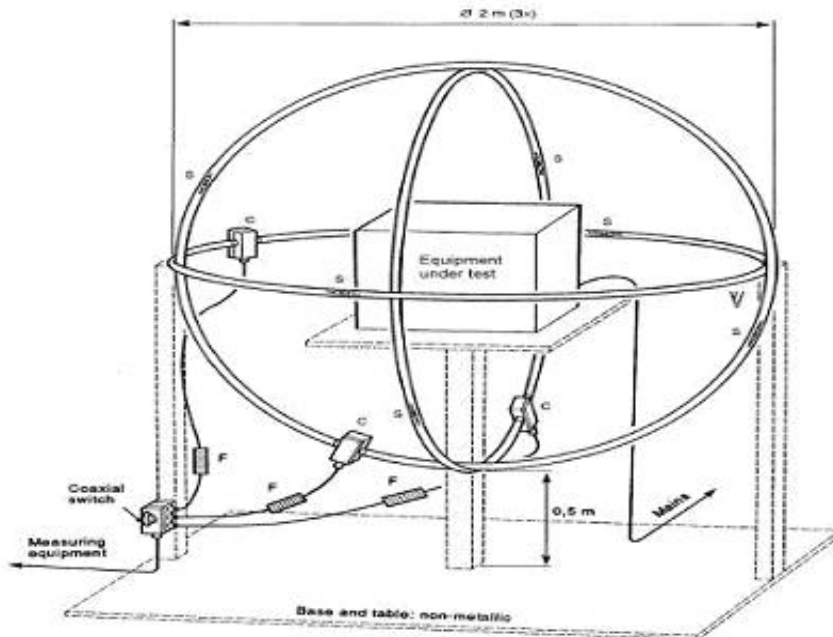

For the actual test configuration, please refer to the related item – Photographs of the Test Configuration.

### 8.2.4. TEST RESULTS

|                              |                   |
|------------------------------|-------------------|
| Temperature ( °C )           | 22~28             |
| Humidity ( %RH )             | 50~58             |
| Barometric Pressure ( mbar ) | 950~1000          |
| EUT                          | TRACK ACCESSORIES |
| M/N                          | 9945              |
| Operating Mode               | Normal Operating  |
| Test Results                 | PASS              |



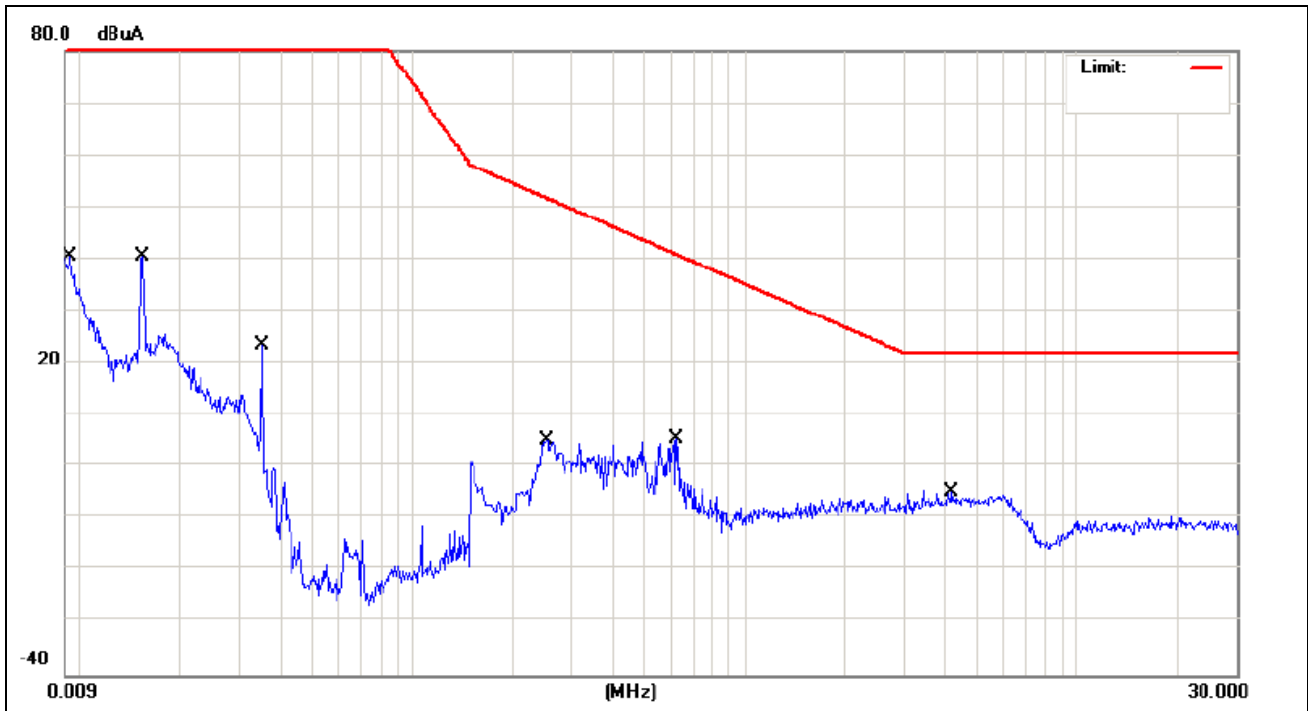

|              |                   |                    |                   |
|--------------|-------------------|--------------------|-------------------|
| EUT:         | TRACK ACCESSORIES | Model Name :       | 9945              |
| Temperature: | 24 °C             | Relative Humidity: | 54%               |
| Pressure:    | 1010 hPa          | Test Date :        | September 28,2016 |
| Test Mode :  | Normal Operating  | Polarization :     | X                 |
| Test Power : | AC 230V/50Hz      |                    |                   |

| Item<br>(Mark) | Freq<br>(MHz) | Read<br>Level<br>(DBμA) | Cable<br>Loss<br>(dB) | Result<br>Level<br>(DBμA) | Limit<br>Line<br>(DBμA) | Over<br>Limit<br>(dB) | Detector | Phase |
|----------------|---------------|-------------------------|-----------------------|---------------------------|-------------------------|-----------------------|----------|-------|
| 1              | 0.01          | 2.71                    | 0.06                  | 2.77                      | 88.00                   | -85.23                | Peak     | X     |
| 2              | 0.03          | 6.80                    | 0.16                  | 6.96                      | 88.00                   | -81.04                | Peak     | X     |
| 3              | 0.06          | -10.03                  | 0.23                  | -9.80                     | 88.00                   | -97.80                | Peak     | X     |
| 4              | 0.08          | -12.77                  | 0.25                  | -12.52                    | 85.09                   | -97.61                | Peak     | X     |
| 5              | 0.17          | -15.37                  | 0.33                  | -15.04                    | 56.72                   | -71.76                | Peak     | X     |
| 6              | 3.92          | -20.51                  | 0.61                  | -19.90                    | 22.00                   | -41.90                | Peak     | X     |

Remark:

1. All readings are Quasi-Peak and Average values.
2. Factor = Antenna Factor + Cable Loss - Amplifier.
3. N/A means All Data have pass Limit.

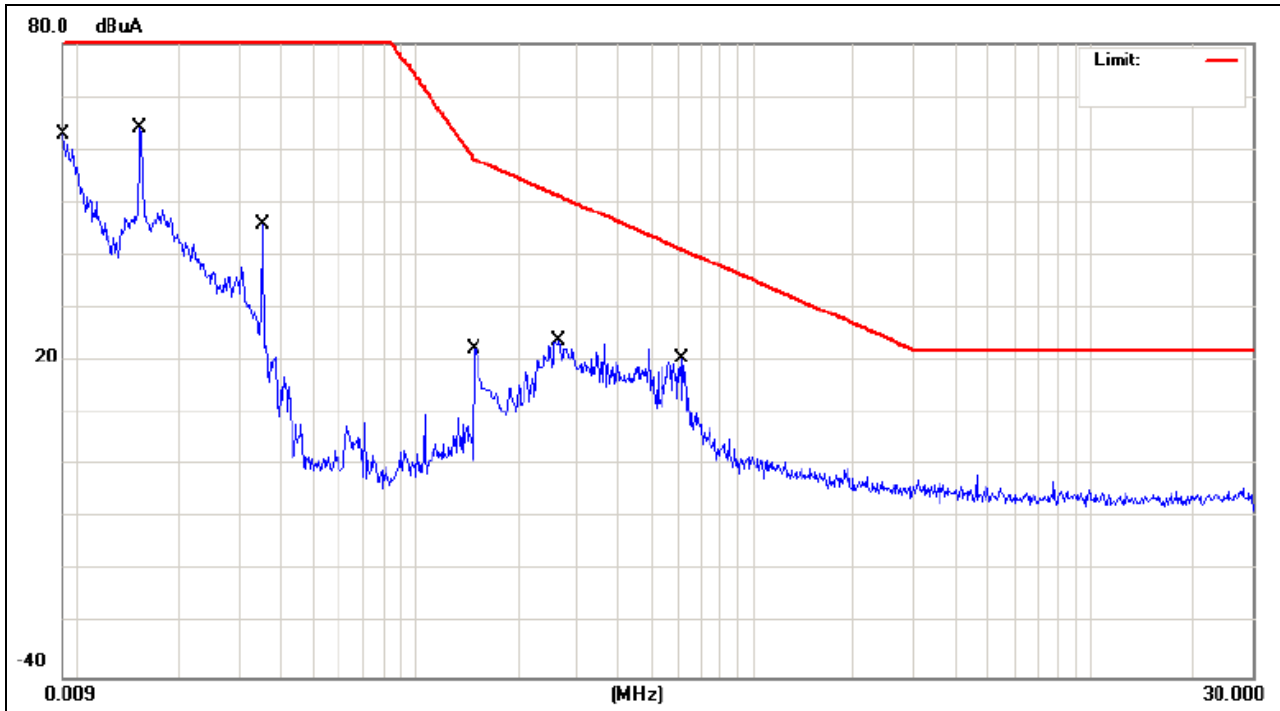

|              |                   |                    |                   |
|--------------|-------------------|--------------------|-------------------|
| EUT:         | TRACK ACCESSORIES | Model Name :       | 9945              |
| Temperature: | 24 °C             | Relative Humidity: | 54%               |
| Pressure:    | 1010 hPa          | Test Date :        | December 22, 2016 |
| Test Mode :  | Normal Operating  | Polarization :     | Y                 |
| Test Power : | AC 230V/50Hz      |                    |                   |

| Item<br>(Mark) | Freq<br>(MHz) | Read<br>Level<br>(DBμA) | Cable<br>Loss<br>(dB) | Result<br>Level<br>(DBμA) | Limit<br>Line<br>(DBμA) | Over<br>Limit<br>(dB) | Detecto<br>r | Phase |
|----------------|---------------|-------------------------|-----------------------|---------------------------|-------------------------|-----------------------|--------------|-------|
| 1              | 0.03          | 19.55                   | 0.17                  | 19.72                     | 88.00                   | -68.28                | Peak         | Y     |
| 2              | 0.07          | 5.55                    | 0.25                  | 5.80                      | 87.64                   | -81.84                | Peak         | Y     |
| 3              | 0.15          | -0.53                   | 0.31                  | -0.22                     | 59.22                   | -59.44                | Peak         | Y     |
| 4              | 0.21          | -4.33                   | 0.35                  | -3.98                     | 53.69                   | -57.67                | Peak         | Y     |
| 5              | 0.39          | -12.49                  | 0.40                  | -12.09                    | 46.38                   | -58.47                | Peak         | Y     |
| 6              | 1.54          | -19.37                  | 0.53                  | -18.84                    | 30.01                   | -48.85                | Peak         | Y     |

Remark:

1. All readings are Quasi-Peak and Average values.
2. Factor = Antenna Factor + Cable Loss - Amplifier.
3. N/A means All Data have pass Limit.

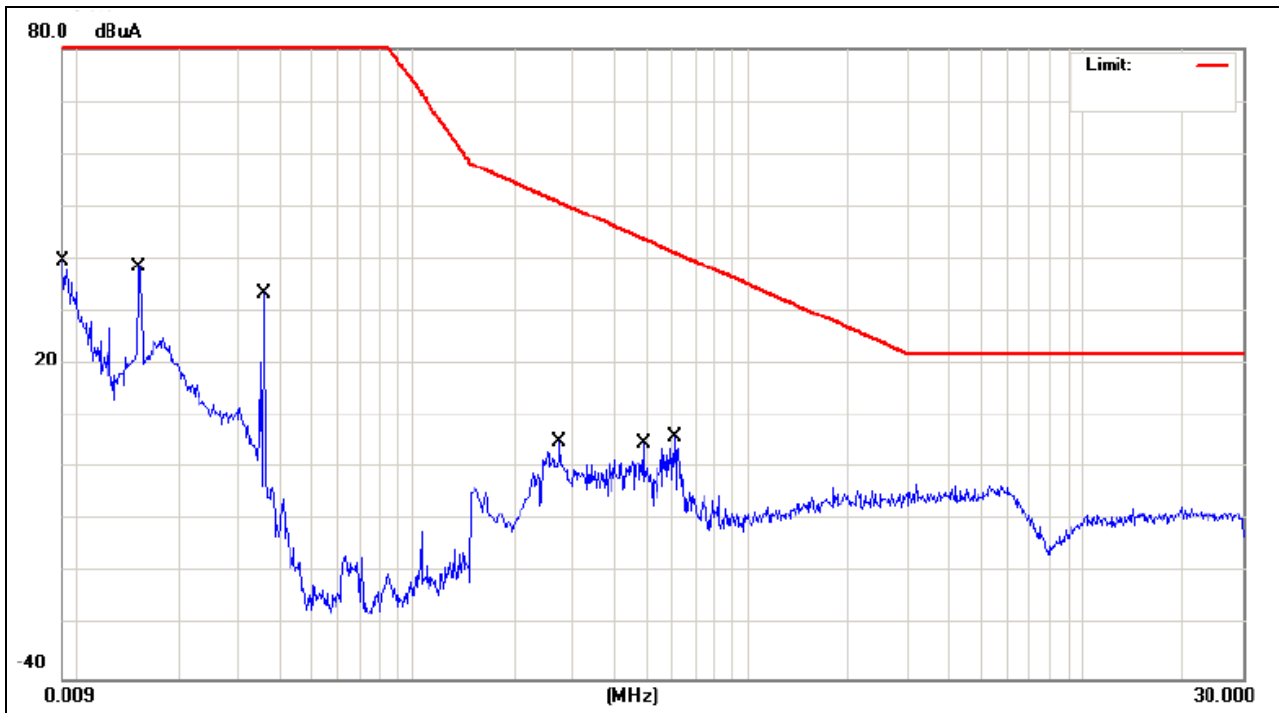

|              |                   |                    |                   |
|--------------|-------------------|--------------------|-------------------|
| EUT:         | TRACK ACCESSORIES | Model Name :       | 9945              |
| Temperature: | 24 °C             | Relative Humidity: | 54%               |
| Pressure:    | 1010 hPa          | Test Date :        | September 28,2016 |
| Test Mode :  | Normal Operating  | Polarization :     | Z                 |
| Test Power : | AC 230V/50Hz      |                    |                   |

| Item<br>(Mark) | Freq<br>(MHz) | Read<br>Level<br>(DBμA) | Cable<br>Loss<br>(dB) | Result<br>Level<br>(DBμA) | Limit<br>Line<br>(DBμA) | Over<br>Limit<br>(dB) | Detector | Phase |
|----------------|---------------|-------------------------|-----------------------|---------------------------|-------------------------|-----------------------|----------|-------|
| 1              | 0.01          | 21.19                   | 0.07                  | 21.26                     | 88.00                   | -66.74                | Peak     | Z     |
| 2              | 0.02          | 11.67                   | 0.13                  | 11.80                     | 88.00                   | -76.20                | Peak     | Z     |
| 3              | 0.04          | 14.88                   | 0.18                  | 15.06                     | 88.00                   | -72.94                | Peak     | Z     |
| 4              | 0.07          | -3.50                   | 0.25                  | -3.25                     | 86.68                   | -89.93                | Peak     | Z     |
| 5              | 0.14          | -14.44                  | 0.31                  | -14.13                    | 59.86                   | -73.99                | Peak     | Z     |
| 6              | 0.40          | -17.88                  | 0.41                  | -17.47                    | 46.29                   | -63.76                | Peak     | Z     |

**Remark:**

1. All readings are Quasi-Peak and Average values.
2. Factor = Antenna Factor + Cable Loss - Amplifier.
3. N/A means All Data have pass Limit.

## 8.3. RADIATED EMISSION MEASUREMENT

### 8.3.1. LIMITS

| FREQUENCY (MHz) | dBuV/m (At 3m) |
|-----------------|----------------|
| 30 ~ 230        | 40             |
| 230 ~ 300       | 47             |

**NOTE:** (1) The lower limit shall apply at the transition frequencies.

(2) Emission level (dBuV/m) = 20 log Emission level (uV/m).

### 8.3.2. TEST PROCEDURE

#### Procedure of Preliminary Test

The equipment was set up as per the test configuration to simulate typical usage per the user's manual. When the EUT is a tabletop system, a wooden turntable with a height of 0.8 meters is used which is placed on the ground plane. When the EUT is a floor standing equipment, it is placed on the ground plane which has a 3-12 mm non-conductive covering to insulate the EUT from the ground plane.

Support equipment, if needed, was placed as per EN 55015.

All I/O cables were positioned to simulate typical usage as per EN 55015.

Mains cables, telephone lines or other connections to auxiliary equipment located outside the test are shall drape to the floor, be fitted with ferrite clamps or ferrite tubes placed on the floor at the point where the cable reaches the floor and then routed to the place where they leave the turntable. No extension cords shall be used to mains receptacle.

The antenna was placed at 3 meter away from the EUT as stated in EN 55015. The antenna connected to the Spectrum Analyzer via a cable and at times a pre-amplifier would be used.

The Analyzer / Receiver quickly scanned from 30MHz to 300MHz. The EUT test program was started. Emissions were scanned and measured rotating the EUT to 360 degrees and positioning the antenna 1 to 4 meters above the ground plane, in both the vertical and the horizontal polarization, to maximize the emission reading level.

The test mode(s) described in Item 3.1 were scanned during the preliminary test:

After the preliminary scan, we found the test mode described in Item 3.1 producing the highest emission level. The EUT and cable configuration, antenna position, polarization and turntable position of the above highest emission level were recorded for the final test.

#### Procedure of Final Test

EUT and support equipment were set up on the turntable as per the configuration with highest emission level in the preliminary test.

The Analyzer / Receiver scanned from 30MHz to 300MHz. Emissions were scanned and measured rotating the EUT to 360 degrees, varying cable placement and positioning the antenna 1 to 4 meters above the ground plane, in both the vertical and the horizontal polarization, to maximize the emission reading level.

Recorded at least the six highest emissions. Emission frequency, amplitude, antenna position, polarization and turntable position were recorded into a computer in which correction factors were used to calculate the emission level and compare reading to the applicable limit and only Q.P. reading is presented.

The test data of the worst-case condition(s) was recorded.

### 8.3.3. TEST SETUP

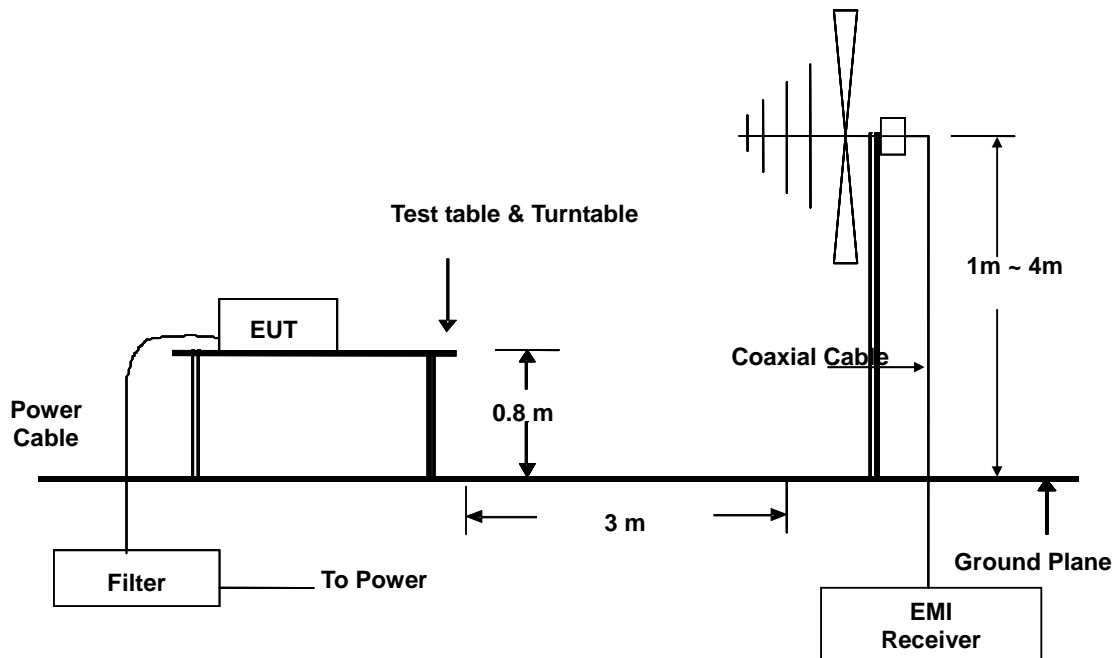

For the actual test configuration, please refer to the related item – Photographs of the Test Configuration.

### 8.3.4 TEST RESULTS

|                              |                   |
|------------------------------|-------------------|
| Temperature ( °C )           | 22~28             |
| Humidity ( %RH )             | 50~58             |
| Barometric Pressure ( mbar ) | 950~1000          |
| EUT                          | TRACK ACCESSORIES |
| M/N                          | 9945              |
| Operating Mode               | Normal Operating  |
| Test Results                 | PASS              |

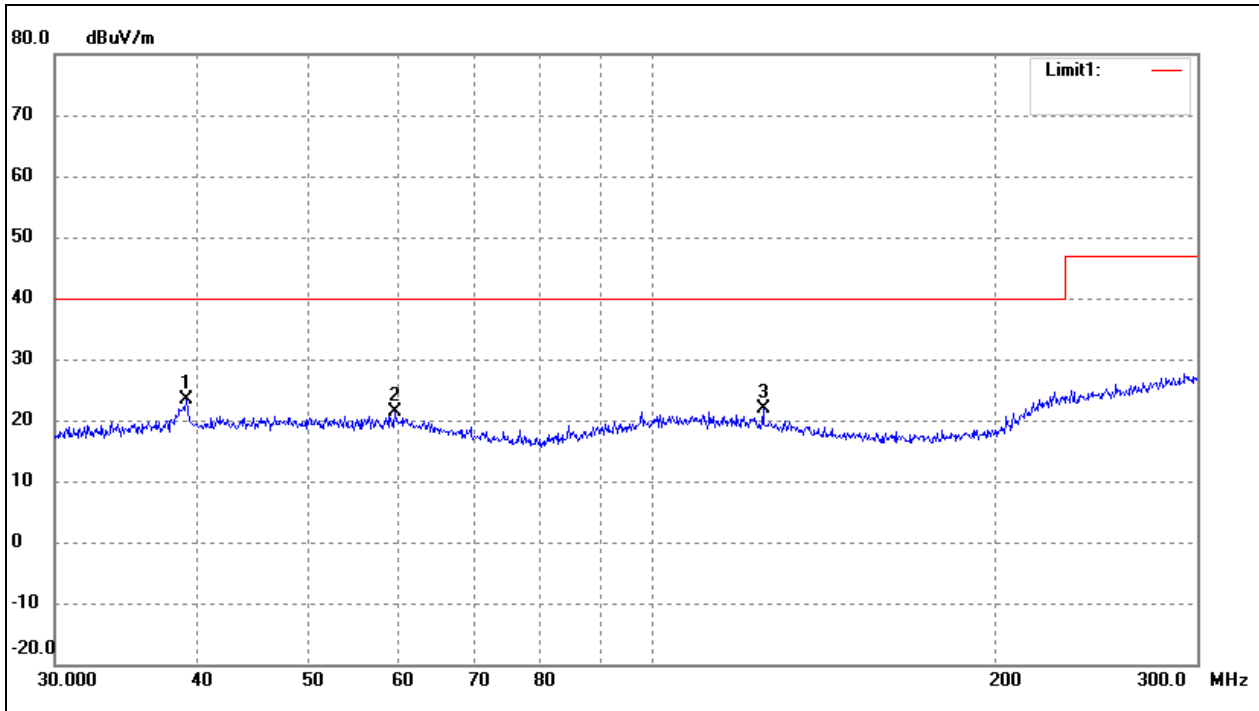

|              |                   |                    |                   |
|--------------|-------------------|--------------------|-------------------|
| EUT:         | TRACK ACCESSORIES | Model Name :       | 9945              |
| Temperature: | 24 °C             | Relative Humidity: | 54%               |
| Pressure:    | 1010 hPa          | Test Date :        | December 22, 2016 |
| Test Mode :  | Normal Operating  | Polarization :     | Vertical          |
| Test Power : | AC 230V/50Hz      |                    |                   |

| No. | Frequency<br>(MHz) | Reading<br>(dBuV/m) | Correct<br>dB/m | Result<br>(dBuV/m) | Limit<br>(dBuV/m) | Margin<br>(dB) | Degree<br>( ) | Height<br>(cm) | Remark |
|-----|--------------------|---------------------|-----------------|--------------------|-------------------|----------------|---------------|----------------|--------|
| 1   | 39.0950            | 18.33               | 5.09            | 23.42              | 40.00             | -16.58         |               |                | peak   |
| 2   | 59.5828            | 15.96               | 5.38            | 21.34              | 40.00             | -18.66         |               |                | peak   |
| 3   | 125.0608           | 17.34               | 4.61            | 21.95              | 40.00             | -18.05         |               |                | peak   |

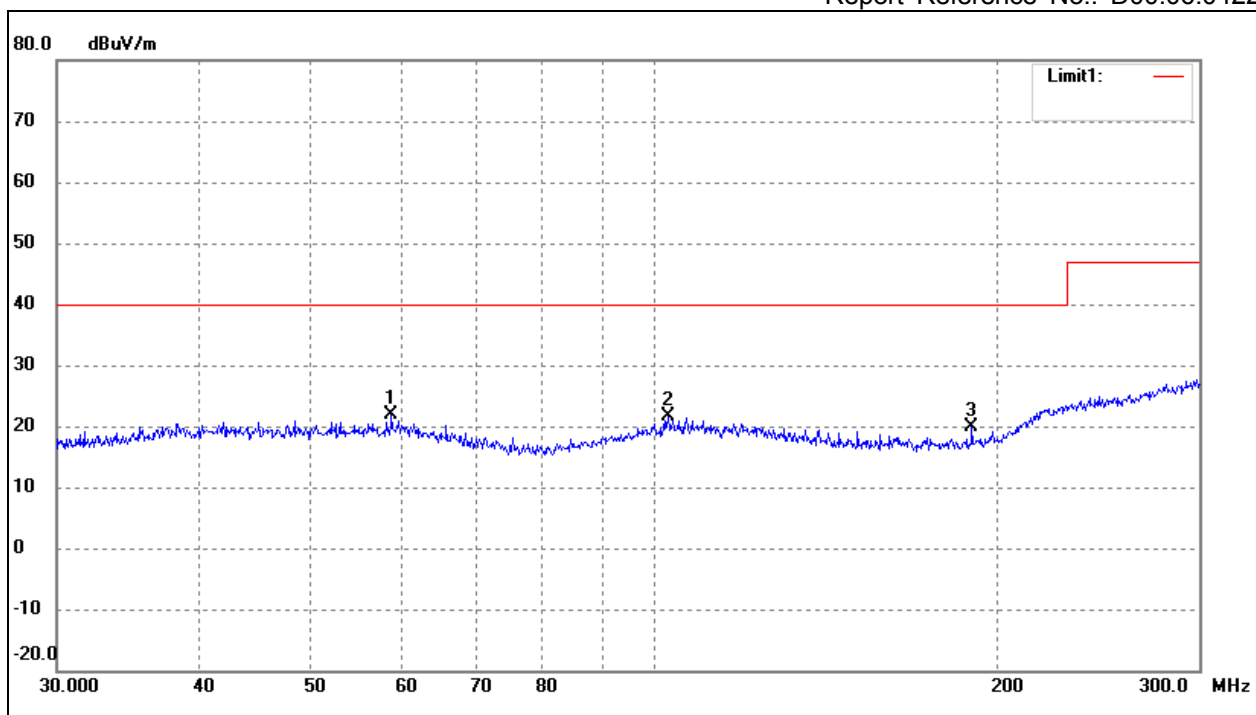

|              |                   |                    |                   |
|--------------|-------------------|--------------------|-------------------|
| EUT:         | TRACK ACCESSORIES | Model Name :       | 9945              |
| Temperature: | 24 °C             | Relative Humidity: | 54%               |
| Pressure:    | 1010 hPa          | Test Date :        | December 22, 2016 |
| Test Mode :  | Normal Operating  | Polarization :     | Horizontal        |
| Test Power : | AC 230V/50Hz      |                    |                   |

| No. | Frequency<br>(MHz) | Reading<br>(dBuV/m) | Correct<br>dB/m | Result<br>(dBuV/m) | Limit<br>(dBuV/m) | Margin<br>(dB) | Degree<br>( ) | Height<br>(cm) | Remark |
|-----|--------------------|---------------------|-----------------|--------------------|-------------------|----------------|---------------|----------------|--------|
| 1   | 58.9008            | 16.43               | 5.37            | 21.80              | 40.00             | -18.20         |               |                | peak   |
| 2   | 102.8303           | 16.58               | 5.12            | 21.70              | 40.00             | -18.30         |               |                | peak   |
| 3   | 189.7236           | 16.71               | 3.20            | 19.91              | 40.00             | -20.09         |               |                | peak   |

## 8.4. HARMONICS CURRENT MEASUREMENT

### 8.4.1. LIMITS OF HARMONICS CURRENT MEASUREMENT

| Limits for Class A equipment |                                      | Limits for Class D equipment |  |                                      |
|------------------------------|--------------------------------------|------------------------------|--|--------------------------------------|
| Harmonics Order n            | Max. permissible harmonics current A | Harmonics Order n            | Max. permissible harmonics current per watt mA/W | Max. permissible harmonics current A |
| Odd harmonics                |                                      | Odd Harmonics only           |  |                                      |
| 3                            | 2.30                                 | 3                            | 3.4  | 2.30                                 |
| 5                            | 1.14                                 | 5                            | 1.9  | 1.14                                 |
| 7                            | 0.77                                 | 7                            | 1.0  | 0.77                                 |
| 9                            | 0.40                                 | 9                            | 0.5  | 0.40                                 |
| 11                           | 0.33                                 | 11                           | 0.35   | 0.33                                 |
| 13                           | 0.21                                 | 13                           | 0.30   | 0.21                                 |
| 15<=n<=39                    | 0.15x15/n                            | 15<=n<=39                    | 3.85/n   | 0.15x15/n                            |
| Even harmonics               |                                      |                              |  |                                      |
| 2                            | 1.08                                 |                              |  |                                      |
| 4                            | 0.43                                 |                              |  |                                      |
| 6                            | 0.30                                 |                              |  |                                      |
| 8<=n<=40                     | 0.23x8/n                             |                              |  |                                      |

**NOTE:** 1. Class A and Class D are classified according to item 4.4.3.

2. According to section 7 of EN 61000-3-2, the above limits apply for all equipments with a rated power more than 75W, except for lighting equipment.

### 8.4.2. TEST PROCEDURE

The EUT was placed on the top of a wooden table 0.8 meters above the ground and operated to produce the maximum harmonic components under LIGHTING operating conditions for each successive harmonic component in turn.

The classification of EUT is according to section 5 of EN 61000-3-2.

The EUT is classified as follows:

Class A: Balanced three-phase equipment, Household appliances excluding equipment as Class D, Tools excluding portable tools, Dimmers for incandescent lamps, audio equipment, equipment not specified in one of the three other classes.

Class B: Portable tools; Arc welding equipment which is not professional equipment.

Class C: Lighting equipment.

Class D: Equipment having a specified power less than or equal to 600 W of the following types: Personal computers and personal computer monitors and television receivers.

The correspondent test program of test instrument to measure the current harmonics emanated from EUT is chosen. The measure time shall be not less than the time necessary for the EUT to be exercised.



### 8.4.3. TEST SETUP

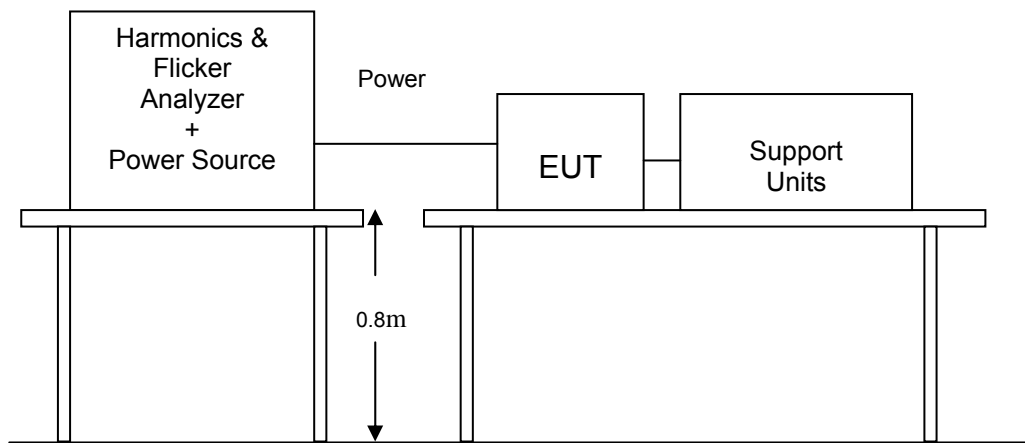

For the actual test configuration, please refer to the related item.

### 8.4.4. TEST RESULTS

|                              |                   |
|------------------------------|-------------------|
| Temperature ( °C )           | 22~28             |
| Humidity ( %RH )             | 50~58             |
| Barometric Pressure ( mbar ) | 950~1000          |
| EUT                          | TRACK ACCESSORIES |
| M/N                          | 9945              |
| Operating Mode               | Normal Operating  |
| Test Results                 | PASS              |

### E. U. T. Result

|  |      |
|--|------|
| Harmonic(s) > 200%:<br>Order (n):  | None |
| Harmonic(s) with average > 90%:<br>Order (n):  | None |
| Harmonic(s) between 150% and 200% during more than 10% of the test time or max. 10min:<br>Order (n): | None |

### Power Source Result

|   |      |
|---|------|
| First dataset out of limit:<br>DS (time): | None |
| Harmonic(s) out of limit:<br>Order (n):   | None |

*Average harmonic current results*

| Hn | I <sub>eff</sub> [A] | I <sub>eff</sub> [%] | Limit [A] | Result |
|----|----------------------|----------------------|-----------|--------|
| 1  | 92.234E-3            | 100.000              |           |        |
| 2  | 655.048E-6           | 0.710                | 972.00E-3 | PASS   |
| 3  | 10.276E-3            | 11.142               | 2.07      | PASS   |
| 4  | 2.069E-3             | 2.244                | 387.00E-3 | PASS   |
| 5  | 4.270E-3             | 4.630                | 1.03      | PASS   |
| 6  | 768.469E-6           | 0.833                | 270.00E-3 | PASS   |
| 7  | 1.351E-3             | 1.465                | 693.00E-3 | PASS   |
| 8  | 804.642E-6           | 0.872                | 207.00E-3 | PASS   |
| 9  | 1.488E-3             | 1.613                | 360.00E-3 | PASS   |
| 10 | 710.588E-6           | 0.770                | 165.60E-3 | PASS   |
| 11 | 1.008E-3             | 1.093                | 297.00E-3 | PASS   |
| 12 | 895.573E-6           | 0.971                | 138.00E-3 | PASS   |
| 13 | 1.778E-3             | 1.928                | 189.00E-3 | PASS   |
| 14 | 891.521E-6           | 0.967                | 118.29E-3 | PASS   |
| 15 | 1.102E-3             | 1.195                | 135.00E-3 | PASS   |
| 16 | 772.700E-6           | 0.838                | 103.50E-3 | PASS   |
| 17 | 1.266E-3             | 1.372                | 119.11E-3 | PASS   |
| 18 | 1.171E-3             | 1.270                | 92.00E-3  | PASS   |
| 19 | 909.143E-6           | 0.986                | 106.58E-3 | PASS   |
| 20 | 808.971E-6           | 0.877                | 82.80E-3  | PASS   |
| 21 | 1.163E-3             | 1.261                | 96.43E-3  | PASS   |
| 22 | 1.048E-3             | 1.136                | 75.28E-3  | PASS   |
| 23 | 1.459E-3             | 1.581                | 88.05E-3  | PASS   |
| 24 | 821.581E-6           | 0.891                | 68.99E-3  | PASS   |
| 25 | 832.532E-6           | 0.903                | 81.00E-3  | PASS   |
| 26 | 786.264E-6           | 0.852                | 63.69E-3  | PASS   |
| 27 | 1.054E-3             | 1.142                | 75.00E-3  | PASS   |
| 28 | 785.917E-6           | 0.852                | 59.14E-3  | PASS   |
| 29 | 779.776E-6           | 0.845                | 69.83E-3  | PASS   |
| 30 | 762.567E-6           | 0.827                | 55.20E-3  | PASS   |
| 31 | 1.101E-3             | 1.194                | 65.32E-3  | PASS   |
| 32 | 862.040E-6           | 0.935                | 51.75E-3  | PASS   |
| 33 | 816.708E-6           | 0.885                | 61.36E-3  | PASS   |
| 34 | 577.011E-6           | 0.626                | 48.71E-3  | PASS   |
| 35 | 881.679E-6           | 0.956                | 57.86E-3  | PASS   |
| 36 | 829.227E-6           | 0.899                | 46.00E-3  | PASS   |
| 37 | 621.672E-6           | 0.674                | 54.73E-3  | PASS   |
| 38 | 658.199E-6           | 0.714                | 43.58E-3  | PASS   |
| 39 | 609.231E-6           | 0.661                | 51.92E-3  | PASS   |
| 40 | 882.731E-6           | 0.957                | 41.40E-3  | PASS   |

*Maximum harmonic current results*

| Hn | I <sub>eff</sub> [A] | I <sub>eff</sub> [%] | Limit [A] | Result |
|----|----------------------|----------------------|-----------|--------|
| 1  | 92.748E-3            | 100.000              |           |        |
| 2  | 727.927E-6           | 0.785                | 2.16      | PASS   |
| 3  | 10.739E-3            | 11.579               | 4.60      | PASS   |
| 4  | 2.219E-3             | 2.392                | 860.00E-3 | PASS   |
| 5  | 4.428E-3             | 4.775                | 2.28      | PASS   |
| 6  | 865.163E-6           | 0.933                | 600.00E-3 | PASS   |
| 7  | 1.516E-3             | 1.634                | 1.54      | PASS   |
| 8  | 949.202E-6           | 1.023                | 460.00E-3 | PASS   |
| 9  | 1.592E-3             | 1.716                | 800.00E-3 | PASS   |
| 10 | 807.329E-6           | 0.870                | 368.00E-3 | PASS   |
| 11 | 1.144E-3             | 1.233                | 660.00E-3 | PASS   |
| 12 | 1.011E-3             | 1.090                | 306.66E-3 | PASS   |
| 13 | 1.871E-3             | 2.017                | 420.00E-3 | PASS   |
| 14 | 1.021E-3             | 1.101                | 262.86E-3 | PASS   |
| 15 | 1.188E-3             | 1.281                | 300.00E-3 | PASS   |
| 16 | 895.833E-6           | 0.966                | 230.00E-3 | PASS   |
| 17 | 1.357E-3             | 1.463                | 264.70E-3 | PASS   |
| 18 | 1.279E-3             | 1.379                | 204.44E-3 | PASS   |
| 19 | 1.010E-3             | 1.089                | 236.84E-3 | PASS   |
| 20 | 957.397E-6           | 1.032                | 184.00E-3 | PASS   |
| 21 | 1.309E-3             | 1.412                | 214.28E-3 | PASS   |
| 22 | 1.160E-3             | 1.250                | 167.28E-3 | PASS   |
| 23 | 1.551E-3             | 1.672                | 195.66E-3 | PASS   |
| 24 | 913.210E-6           | 0.985                | 153.32E-3 | PASS   |
| 25 | 980.837E-6           | 1.058                | 180.00E-3 | PASS   |
| 26 | 872.214E-6           | 0.940                | 141.54E-3 | PASS   |
| 27 | 1.164E-3             | 1.255                | 166.66E-3 | PASS   |
| 28 | 866.918E-6           | 0.935                | 131.42E-3 | PASS   |
| 29 | 874.169E-6           | 0.943                | 155.18E-3 | PASS   |
| 30 | 821.839E-6           | 0.886                | 122.66E-3 | PASS   |
| 31 | 1.226E-3             | 1.321                | 145.16E-3 | PASS   |
| 32 | 1.001E-3             | 1.080                | 115.00E-3 | PASS   |
| 33 | 889.147E-6           | 0.959                | 136.36E-3 | PASS   |
| 34 | 702.045E-6           | 0.757                | 108.24E-3 | PASS   |
| 35 | 1.056E-3             | 1.138                | 128.58E-3 | PASS   |
| 36 | 1.049E-3             | 1.131                | 102.22E-3 | PASS   |
| 37 | 683.656E-6           | 0.737                | 121.62E-3 | PASS   |
| 38 | 720.106E-6           | 0.776                | 96.84E-3  | PASS   |
| 39 | 704.946E-6           | 0.760                | 115.38E-3 | PASS   |
| 40 | 962.540E-6           | 1.038                | 92.00E-3  | PASS   |

*Maximum harmonic voltage results*

| Hn | Ueff [V]  | Ueff [%] | Limit [%] | Result |
|----|-----------|----------|-----------|--------|
| 1  | 231.34    | 100.581  |           |        |
| 2  | 75.91E-3  | 0.033    | 0.2       | PASS   |
| 3  | 105.53E-3 | 0.046    | 0.9       | PASS   |
| 4  | 19.46E-3  | 0.008    | 0.2       | PASS   |
| 5  | 46.33E-3  | 0.020    | 0.4       | PASS   |
| 6  | 14.92E-3  | 0.006    | 0.2       | PASS   |
| 7  | 27.95E-3  | 0.012    | 0.3       | PASS   |
| 8  | 15.24E-3  | 0.007    | 0.2       | PASS   |
| 9  | 21.85E-3  | 0.009    | 0.2       | PASS   |
| 10 | 11.40E-3  | 0.005    | 0.2       | PASS   |
| 11 | 34.46E-3  | 0.015    | 0.1       | PASS   |
| 12 | 12.73E-3  | 0.006    | 0.1       | PASS   |
| 13 | 46.01E-3  | 0.020    | 0.1       | PASS   |
| 14 | 10.98E-3  | 0.005    | 0.1       | PASS   |
| 15 | 26.03E-3  | 0.011    | 0.1       | PASS   |
| 16 | 13.69E-3  | 0.006    | 0.1       | PASS   |
| 17 | 12.56E-3  | 0.005    | 0.1       | PASS   |
| 18 | 11.05E-3  | 0.005    | 0.1       | PASS   |
| 19 | 32.97E-3  | 0.014    | 0.1       | PASS   |
| 20 | 11.27E-3  | 0.005    | 0.1       | PASS   |
| 21 | 38.02E-3  | 0.017    | 0.1       | PASS   |
| 22 | 10.70E-3  | 0.005    | 0.1       | PASS   |
| 23 | 30.86E-3  | 0.013    | 0.1       | PASS   |
| 24 | 13.61E-3  | 0.006    | 0.1       | PASS   |
| 25 | 14.13E-3  | 0.006    | 0.1       | PASS   |
| 26 | 12.75E-3  | 0.006    | 0.1       | PASS   |
| 27 | 24.97E-3  | 0.011    | 0.1       | PASS   |
| 28 | 14.51E-3  | 0.006    | 0.1       | PASS   |
| 29 | 36.73E-3  | 0.016    | 0.1       | PASS   |
| 30 | 11.32E-3  | 0.005    | 0.1       | PASS   |
| 31 | 31.84E-3  | 0.014    | 0.1       | PASS   |
| 32 | 9.87E-3   | 0.004    | 0.1       | PASS   |
| 33 | 18.26E-3  | 0.008    | 0.1       | PASS   |
| 34 | 11.12E-3  | 0.005    | 0.1       | PASS   |
| 35 | 16.71E-3  | 0.007    | 0.1       | PASS   |
| 36 | 9.52E-3   | 0.004    | 0.1       | PASS   |
| 37 | 27.14E-3  | 0.012    | 0.1       | PASS   |
| 38 | 11.82E-3  | 0.005    | 0.1       | PASS   |
| 39 | 25.43E-3  | 0.011    | 0.1       | PASS   |
| 40 | 11.20E-3  | 0.005    | 0.1       | PASS   |

Harmonic current results - DS: 12

| Hn | I <sub>eff</sub> [A] | I <sub>eff</sub> [%] | Limit [A] | Result |
|----|----------------------|----------------------|-----------|--------|
| 1  | 92.712E-3            | 100.000              |           |        |
| 2  | 704.608E-6           | 0.760                | 1.08      | PASS   |
| 3  | 10.639E-3            | 11.475               | 2.30      | PASS   |
| 4  | 2.139E-3             | 2.307                | 430.00E-3 | PASS   |
| 5  | 4.299E-3             | 4.636                | 1.14      | PASS   |
| 6  | 832.811E-6           | 0.898                | 300.00E-3 | PASS   |
| 7  | 1.445E-3             | 1.559                | 770.00E-3 | PASS   |
| 8  | 884.116E-6           | 0.954                | 230.00E-3 | PASS   |
| 9  | 1.363E-3             | 1.470                | 400.00E-3 | PASS   |
| 10 | 763.749E-6           | 0.824                | 184.00E-3 | PASS   |
| 11 | 875.233E-6           | 0.944                | 330.00E-3 | PASS   |
| 12 | 972.537E-6           | 1.049                | 153.33E-3 | PASS   |
| 13 | 1.856E-3             | 2.001                | 210.00E-3 | PASS   |
| 14 | 979.993E-6           | 1.057                | 131.43E-3 | PASS   |
| 15 | 1.026E-3             | 1.106                | 150.00E-3 | PASS   |
| 16 | 839.819E-6           | 0.906                | 115.00E-3 | PASS   |
| 17 | 1.220E-3             | 1.316                | 132.35E-3 | PASS   |
| 18 | 1.218E-3             | 1.314                | 102.22E-3 | PASS   |
| 19 | 904.638E-6           | 0.976                | 118.42E-3 | PASS   |
| 20 | 936.464E-6           | 1.010                | 92.00E-3  | PASS   |
| 21 | 1.018E-3             | 1.098                | 107.14E-3 | PASS   |
| 22 | 1.055E-3             | 1.138                | 83.64E-3  | PASS   |
| 23 | 1.318E-3             | 1.422                | 97.83E-3  | PASS   |
| 24 | 860.203E-6           | 0.928                | 76.66E-3  | PASS   |
| 25 | 935.082E-6           | 1.009                | 90.00E-3  | PASS   |
| 26 | 854.993E-6           | 0.922                | 70.77E-3  | PASS   |
| 27 | 994.117E-6           | 1.072                | 83.33E-3  | PASS   |
| 28 | 829.497E-6           | 0.895                | 65.71E-3  | PASS   |
| 29 | 780.429E-6           | 0.842                | 77.59E-3  | PASS   |
| 30 | 734.336E-6           | 0.792                | 61.33E-3  | PASS   |
| 31 | 1.049E-3             | 1.131                | 72.58E-3  | PASS   |
| 32 | 887.986E-6           | 0.958                | 57.50E-3  | PASS   |
| 33 | 759.486E-6           | 0.819                | 68.18E-3  | PASS   |
| 34 | 613.586E-6           | 0.662                | 54.12E-3  | PASS   |
| 35 | 1.038E-3             | 1.120                | 64.29E-3  | PASS   |
| 36 | 693.755E-6           | 0.748                | 51.11E-3  | PASS   |
| 37 | 652.006E-6           | 0.703                | 60.81E-3  | PASS   |
| 38 | 679.788E-6           | 0.733                | 48.42E-3  | PASS   |
| 39 | 625.308E-6           | 0.674                | 57.69E-3  | PASS   |
| 40 | 874.345E-6           | 0.943                | 46.00E-3  | PASS   |

Caution: Results related to the 100% limit values

Harmonic voltage results - DS: 12

| Hn | Ueff [V] | Ueff [%] | Limit [%] | Result |
|----|----------|----------|-----------|--------|
| 1  | 231.31   | 100.571  |           |        |
| 2  | 60.54E-3 | 0.026    | 0.2       | PASS   |
| 3  | 70.76E-3 | 0.031    | 0.9       | PASS   |
| 4  | 12.76E-3 | 0.006    | 0.2       | PASS   |
| 5  | 43.49E-3 | 0.019    | 0.4       | PASS   |
| 6  | 9.52E-3  | 0.004    | 0.2       | PASS   |
| 7  | 11.86E-3 | 0.005    | 0.3       | PASS   |
| 8  | 9.42E-3  | 0.004    | 0.2       | PASS   |
| 9  | 6.10E-3  | 0.003    | 0.2       | PASS   |
| 10 | 2.47E-3  | 0.001    | 0.2       | PASS   |
| 11 | 28.26E-3 | 0.012    | 0.1       | PASS   |
| 12 | 7.73E-3  | 0.003    | 0.1       | PASS   |
| 13 | 34.07E-3 | 0.015    | 0.1       | PASS   |
| 14 | 4.93E-3  | 0.002    | 0.1       | PASS   |
| 15 | 22.34E-3 | 0.010    | 0.1       | PASS   |
| 16 | 7.46E-3  | 0.003    | 0.1       | PASS   |
| 17 | 7.60E-3  | 0.003    | 0.1       | PASS   |
| 18 | 3.05E-3  | 0.001    | 0.1       | PASS   |
| 19 | 27.28E-3 | 0.012    | 0.1       | PASS   |
| 20 | 6.86E-3  | 0.003    | 0.1       | PASS   |
| 21 | 26.25E-3 | 0.011    | 0.1       | PASS   |
| 22 | 2.17E-3  | 0.001    | 0.1       | PASS   |
| 23 | 26.23E-3 | 0.011    | 0.1       | PASS   |
| 24 | 6.31E-3  | 0.003    | 0.1       | PASS   |
| 25 | 11.13E-3 | 0.005    | 0.1       | PASS   |
| 26 | 3.71E-3  | 0.002    | 0.1       | PASS   |
| 27 | 15.02E-3 | 0.007    | 0.1       | PASS   |
| 28 | 2.47E-3  | 0.001    | 0.1       | PASS   |
| 29 | 26.57E-3 | 0.012    | 0.1       | PASS   |
| 30 | 7.69E-3  | 0.003    | 0.1       | PASS   |
| 31 | 21.76E-3 | 0.009    | 0.1       | PASS   |
| 32 | 2.83E-3  | 0.001    | 0.1       | PASS   |
| 33 | 12.78E-3 | 0.006    | 0.1       | PASS   |
| 34 | 2.58E-3  | 0.001    | 0.1       | PASS   |
| 35 | 7.26E-3  | 0.003    | 0.1       | PASS   |
| 36 | 2.74E-3  | 0.001    | 0.1       | PASS   |
| 37 | 19.96E-3 | 0.009    | 0.1       | PASS   |
| 38 | 7.82E-3  | 0.003    | 0.1       | PASS   |
| 39 | 18.18E-3 | 0.008    | 0.1       | PASS   |
| 40 | 4.23E-3  | 0.002    | 0.1       | PASS   |

## 8.5. VOLTAGE FLUCTUATION AND FLICKS MEASUREMENT

### 8.5.1. LIMITS OF VOLTAGE FLUCTUATION AND FLICKS MEASUREMENT

| TEST ITEM     | LIMIT | REMARK   |
|---------------|-------|--|
| $P_{st}$      | 1.0   | $P_{st}$ means short-term flicker indicator.     |
| $P_{lt}$      | 0.65  | $P_{lt}$ means long-term flicker indicator.      |
| $T_{dt}$ (ms) | 500   | $T_{dt}$ means maximum time that dt exceeds 3 %. |
| $d_{max}$ (%) | 4%    | $d_{max}$ means maximum relative voltage change. |
| dc (%)        | 3.3%  | dc means relative steady-state voltage change    |

### 8.5.2. TEST PROCEDURE

The EUT was placed on the top of a wooden table 0.8 meters above the ground and operated to produce the most unfavorable sequence of voltage changes under LIGHTING operating conditions.

During the flick measurement, the measure time shall include that part of whole operation cycle in which the EUT produce the most unfavorable sequence of voltage changes. The observation period for short-term flicker indicator is 10 minutes and the observation period for long-term flicker indicator is 2 hours.

### 8.5.3. TEST SETUP

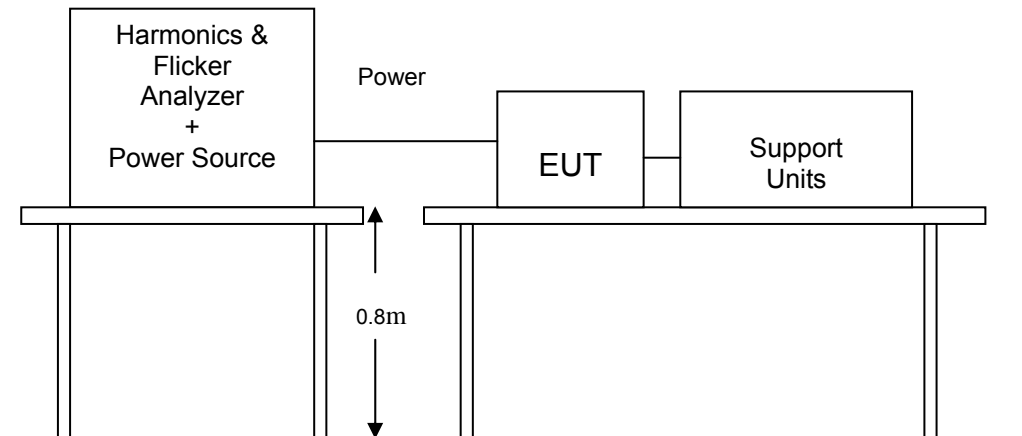

For the actual test configuration, please refer to the related item.



#### 8.5.4. TEST RESULTS

|                              |                   |
|------------------------------|-------------------|
| Temperature ( °C )           | 22~28             |
| Humidity ( %RH )             | 50~58             |
| Barometric Pressure ( mbar ) | 950~1000          |
| EUT                          | TRACK ACCESSORIES |
| M/N                          | 9945              |
| Operating Mode               | Normal Operating  |
| Test Results                 | PASS              |

#### Maximum Flicker results

|          | EUT values | Limit | Result |
|----------|------------|-------|--------|
| Pst      | 0.028      | 1.00  | PASS   |
| Plt      | 0.028      | 0.65  | PASS   |
| dc [%]   | 0.005      | 3.30  | PASS   |
| dmax [%] | 0.269      | 4.00  | PASS   |
| dt [s]   | 0.000      | 0.50  | PASS   |

## 9. IMMUNITY TEST

### 9.1. GENERAL DESCRIPTION

| Product Standard  | EN 61547: 2009                       |  |
|---|--------------------------------------|--|
|   | Test Type                            | Minimum Requirement  |
| Basic Standard, Specification, and Performance Criterion required | EN61000-4-2:2009                     | Electrostatic Discharge – ESD:<br>8kV air discharge, 4kV Contact discharge,<br>Performance Criterion B   |
|   | EN61000-4-3:2006+A1:2008<br>+A2:2010 | Radio-Frequency Electromagnetic Field<br>Susceptibility Test – RS:<br>80 ~1000 MHz, 3V/m, 80% AM(1kHz),<br>Performance Criterion A   |
|   | EN61000-4-4:2012                     | Electrical Fast Transient/Burst - EFT,<br>Power line: 1kV, Signal line: 0.5kV,<br>Performance Criterion B  |
|   | EN61000-4-5:2014                     | Surge Immunity Test:<br>1.2/50 us Open Circuit Voltage,<br>8 /20 us Short Circuit Current,<br>Power Port ~ Line to line: 0.5kV, Line to ground: 1kV<br>( to self-ballasted lamps and semi-luminaires;<br>luminaires and independent auxiliaries which are<br>less than 25W)<br>Power Port ~ Line to line: 1kV, Line to ground: 2kV<br>(to luminaires and independent auxiliaries which are<br>more than 25W)<br>Signal Port : 0.5kV<br>Performance Criterion B |
|   | EN61000-4-6:2014                     | Conducted Radio Frequency Disturbances Test –CS:<br>0.15 ~ 80 MHz, 3Vrms, 80% AM, 1kHz,<br>Performance Criterion A   |
|   | EN61000-4-8:2010                     | Power frequency magnetic field immunity test<br>50 Hz, 3A/m<br>Performance Criterion A   |
|   | EN61000-4-11:2004                    | Voltage Dips and Interruptions:<br>ii) 30% reduction for 10 period,<br>Performance Criterion C<br>100% reduction for 0.5 period<br>Performance Criterion B   |

## 9.2. GENERAL PERFORMANCE CRITERIA DESCRIPTION

|                    |   |
|--------------------|---|
| <b>Criteria A:</b> | During the test no change of the luminous intensity shall be observed and the regulating control, if any, shall operate during the test as intended.  |
| <b>Criteria B:</b> | During the test the luminous intensity may change to any value. After the test the luminous intensity shall be restored to its initial value within 1 min.<br>Regulating controls need not function during the test, but after the test the mode of the control shall be the same as before the test provided that during the test no mode changing commands were given.  |
| <b>Criteria C:</b> | During and after the test any change of the luminous intensity is allowed and the lamp(s) may be extinguished. After the test, within 30 min, all functions shall return to Ceiling Mounted Luminaires if necessary by temporary interruption of the mains supply and/or operating the regulating control.<br>Additional requirement for lighting equipment incorporating a starting device: After the test the lighting equipment is switched off. After half an hour it is switched on again. The lighting equipment shall start and operate as intended. |

## 9.3. ELECTROSTATIC DISCHARGE (ESD)

### 9.3.1. TEST SPECIFICATION

|                               |   |
|-------------------------------|---|
| <b>Basic Standard:</b>        | EN 61000-4-2  |
| <b>Discharge Impedance:</b>   | 330ohm  |
| <b>Charging Capacity:</b>     | 150pF   |
| <b>Discharge Voltage:</b>     | Air Discharge: 8 kV (Direct)<br>Contact Discharge: 4 kV (Direct/Indirect) |
| <b>Polarity:</b>              | Positive & Negative   |
| <b>Number of Discharge:</b>   | Minimum 10 times at each test point                                       |
| <b>Discharge Mode:</b>        | 1 time/s  |
| <b>Performance Criterion:</b> | B   |

### 9.3.2. TEST PROCEDURE

The discharges shall be applied in two ways:

- a) Contact discharges to the conductive surfaces and coupling planes:  
Twenty dischargers (10 with positive and 10 with negative polarity) shall be applied on each accessible metallic part of the enclosure, terminals are excluded. In case of a non-conductive enclosure, dischargers shall be applied on the horizontal or vertical coupling planes. Test shall be performed at a maximum repetition rate of one discharge per second.
- b) Air discharges at slots and apertures and insulating surfaces:  
On those parts of the EUT where it is not possible to perform contact discharge testing, the equipment should be investigated to identify user accessible points where breakdown may occur. Such points are tested using the air discharge method. This investigation should be restricted to those area normally handled by the user. A minimum of 10 single air discharges shall be applied to the selected test point for each such area.

The basic test procedure was in accordance with IEC 61000-4-2:

- a) The EUT was located 0.1 m minimum from all side of the **HCP** (dimensions 1.6m x 0.8m).
- b) The support units were located another table 30 cm away from the EUT, but direct support unit was/were located at same location as EUT on the HCP and keep at a distance of 10 cm with EUT.
- c) The time interval between two successive single discharges was at least 1 second.
- d) Contact discharges were applied to the non-insulating coating, with the pointed tip of the generator penetrating the coating and contacting the conducting substrate.
- e) Air discharges were applied with the round discharge tip of the discharge electrode approaching the EUT as fast as possible (without causing mechanical damage) to touch the EUT. After each discharge, the ESD generator was removed from the EUT and re-triggered for a new single discharge. The test was repeated until all discharges were complete.
- f) At least ten single discharges (in the most sensitive polarity) were applied at the front edge of each **HCP** opposite the center point of each unit of the EUT and 0.1 meters from the front of the EUT. The long axis of the discharge electrode was in the plane of the **HCP** and perpendicular to its front edge during the discharge.
- g) At least ten single discharges (in the most sensitive polarity) were applied to the center of one vertical edge of the **Vertical Coupling Plane (VCP)** in sufficiently different positions that the four faces of the EUT were completely illuminated. The **VCP** (dimensions 0.5m x 0.5m) was placed vertically to and 0.1 meters from the EUT.

### 9.3.3. TEST SETUP

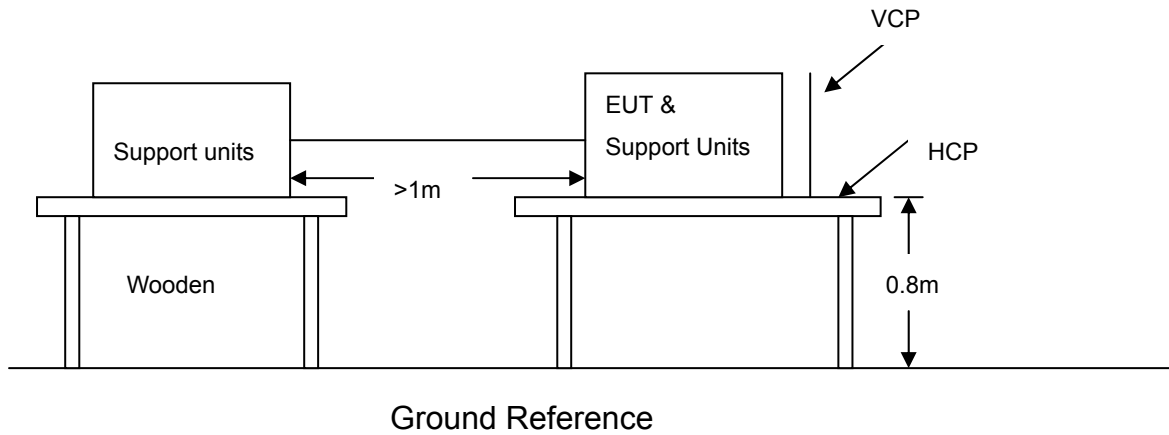

For the actual test configuration, please refer to the related item – Photographs of the Test Configuration.

**NOTE:**

TABLE-TOP EQUIPMENT

The configuration consisted of a wooden table 0.8 meters high standing on the **Ground Reference Plane**. The **GRP** consisted of a sheet of aluminum at least 0.25mm thick, and 2.5 meters square connected to the protective grounding system. A **Horizontal Coupling Plane** (1.6m x 0.8m) was placed on the table and attached to the **GRP** by means of a cable with 940k total impedance. The equipment under test, was installed in a representative system as described in section 7 of EN 61000-4-2, and its cables were placed on the **HCP** and isolated by an insulating support of 0.5mm thickness. A distance of 1-meter minimum was provided between the EUT and the walls of the laboratory and any other metallic structure.

FLOOR-STANDING EQUIPMENT

The equipment under test was installed in a representative system as described in section 7 of IEC 61000-4-2, and its cables were isolated from the Ground Reference Plane by an insulating support of 0.1-meter thickness. The GRP consisted of a sheet of aluminum that is at least 0.25mm thick, and 2.5 meters square connected to the protective grounding system and extended at least 0.5 meters from the EUT on all sides.

### 9.3.4. TEST RESULTS

|                              |                   |
|------------------------------|-------------------|
| Temperature ( °C )           | 22~28             |
| Humidity ( %RH )             | 50~58             |
| Barometric Pressure ( mbar ) | 950~1000          |
| EUT                          | TRACK ACCESSORIES |
| M/N                          | 9945              |
| Operating Mode               | Normal Operating  |
| Test Results                 | PASS              |

| Air Discharge |         |                                     |                                     |                          |                       |   |
|---------------|---------|-------------------------------------|-------------------------------------|--------------------------|-----------------------|---|
| Test Points   |         | Test Levels                         | Results                             |                          |                       |   |
|               |         | ± 8 kV                              | Pass                                | Fail                     | Performance Criterion | Observation   |
| Slots         | 6Points | <input checked="" type="checkbox"/> | <input checked="" type="checkbox"/> | <input type="checkbox"/> | B                     | Note <input type="checkbox"/> 1 <input checked="" type="checkbox"/> 2 |
| Port          | 2Points | <input checked="" type="checkbox"/> | <input checked="" type="checkbox"/> | <input type="checkbox"/> | B                     | Note <input type="checkbox"/> 1 <input checked="" type="checkbox"/> 2 |

| Contact Discharge |         |                                     |                                     |                          |                       |   |
|-------------------|---------|-------------------------------------|-------------------------------------|--------------------------|-----------------------|---|
| Test Points       |         | Test Levels                         | Results                             |                          |                       |   |
|                   |         | ± 4 kV                              | Pass                                | Fail                     | Performance Criterion | Observation   |
| Metal             | 4Points | <input checked="" type="checkbox"/> | <input checked="" type="checkbox"/> | <input type="checkbox"/> | B                     | Note <input type="checkbox"/> 1 <input checked="" type="checkbox"/> 2 |
| HCP               | 4Points | <input checked="" type="checkbox"/> | <input checked="" type="checkbox"/> | <input type="checkbox"/> | B                     | Note <input type="checkbox"/> 1 <input checked="" type="checkbox"/> 2 |
| VCP               | 4Points | <input checked="" type="checkbox"/> | <input checked="" type="checkbox"/> | <input type="checkbox"/> | B                     | Note <input type="checkbox"/> 1 <input checked="" type="checkbox"/> 2 |

- NOTE:** 1. There was no change compared with initial operation during the test.  
 2. The loss of function of the EUT during the test and it was recovered by itself operation after the test.

## 9.4. RADIATED, RADIO-FREQUENCY, ELECTROMAGNETIC FIELD (RS)

### 9.4.1. TEST SPECIFICATION

|                               |                                    |
|-------------------------------|------------------------------------|
| <b>Basic Standard:</b>        | EN 61000-4-3                       |
| <b>Frequency Range:</b>       | 80 MHz ~1000 MHz,                  |
| <b>Field Strength:</b>        | 3 V/m                              |
| <b>Modulation:</b>            | 1kHz Sine Wave, 80%, AM Modulation |
| <b>Frequency Step:</b>        | 1 % of preceding frequency value   |
| <b>Polarity of Antenna:</b>   | Horizontal and Vertical            |
| <b>Test Distance:</b>         | 3 m                                |
| <b>Antenna Height:</b>        | 1.5m                               |
| <b>Performance Criterion:</b> | A                                  |

### 9.4.2. TEST PROCEDURE

The test procedure was in accordance with EN 61000-4-3

- a) The testing was performed in a fully anechoic chamber. The transmit antenna was located at a distance of 3 meters from the EUT.
- b) The frequency range is swept from 80 MHz to 1000 MHz, with the signal 80% amplitude modulated with a 1 kHz sine-wave. The rate of sweep did not exceed  $1.5 \times 10^{-3}$  decade/s, where the frequency range is swept incrementally; the step size was 1% of preceding frequency value.
- c) The dwell time at each frequency shall be not less than the time necessary for the EUT to be able to respond.
- d) The test was performed with the EUT exposed to both vertically and horizontally polarized fields on each of the four sides.

### 9.4.3. TEST SETUP

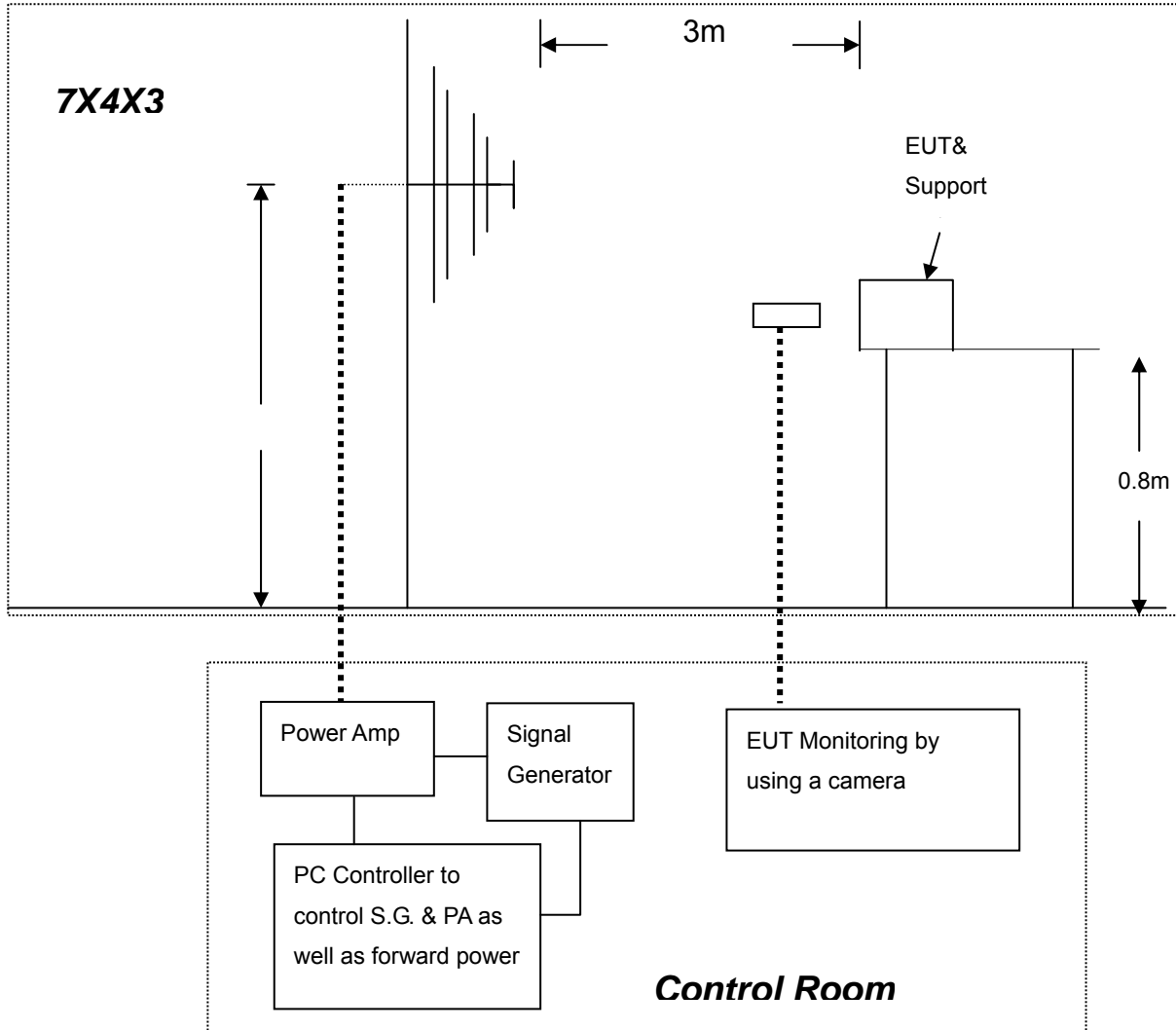

For the actual test configuration, please refer to the related item.

**NOTE:**

TABLETOP EQUIPMENT

The EUT installed in a representative system as described in section 7 of EN 61000-4-3 was placed on a non-conductive table 0.8 meters in height. The system under test was connected to the power and signal wire according to relevant installation instructions.

FLOOR STANDING EQUIPMENT

The EUT installed in a representative system as described in section 7 of IEC 61000-4-3 was placed on a non-conductive wood support 0.1 meters in height. The system under test was connected to the power and signal wire according to relevant installation instructions.



#### 9.4.4. TEST RESULTS

|                              |                   |
|------------------------------|-------------------|
| Temperature ( °C )           | 22~28             |
| Humidity ( %RH )             | 50~58             |
| Barometric Pressure ( mbar ) | 950~1000          |
| EUT                          | TRACK ACCESSORIES |
| M/N                          | 9945              |
| Operating Mode               | Normal Operating  |
| Test Results                 | PASS              |

| Frequency (MHz) | Polarity | Position | Field Strength (V/m) | Observation | Result |
|-----------------|----------|----------|----------------------|-------------|--------|
| 80 ~ 1000       | V&H      | Front    | 3                    | Note        | PASS   |
| 80 ~ 1000       | V&H      | Rear     | 3                    | Note        | PASS   |
| 80 ~ 1000       | V&H      | Left     | 3                    | Note        | PASS   |
| 80 ~ 1000       | V&H      | Right    | 3                    | Note        | PASS   |

**NOTE:** There was no change compared with the initial operation during the test.

## 9.5. ELECTRICAL FAST TRANSIENT (EFT)

### 9.5.1. TEST SPECIFICATION

|                               |   |
|-------------------------------|---|
| <b>Basic Standard:</b>        | EN 61000-4-4                                    |
| <b>Test Voltage:</b>          | Power Line: 1 kV<br>Signal/Control Line: 0.5 kV |
| <b>Polarity:</b>              | Positive & Negative                             |
| <b>Impulse Frequency:</b>     | 5 kHz   |
| <b>Impulse Wave-shape:</b>    | 5/50 ns   |
| <b>Burst Duration:</b>        | 15 ms   |
| <b>Burst Period:</b>          | 300ms   |
| <b>Test Duration:</b>         | Not less than 1 min.                            |
| <b>Performance Criterion:</b> | B   |

### 9.5.2. TEST PROCEDURE

- a) Both positive and negative polarity discharges were applied.
- b) The length of the “hot wire” from the coaxial output of the EFT generator to the terminals on the EUT should not exceed 1 meter.
- c) The duration time of each test sequential was 1 minute.
- d) The transient/burst waveform was in accordance with EN 61000-4-4, 5/50ns.

### 9.5.3. TEST SETUP

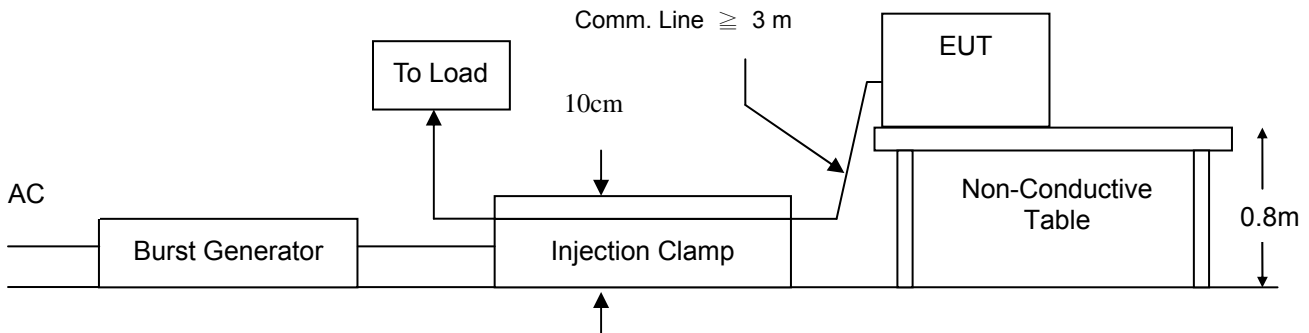
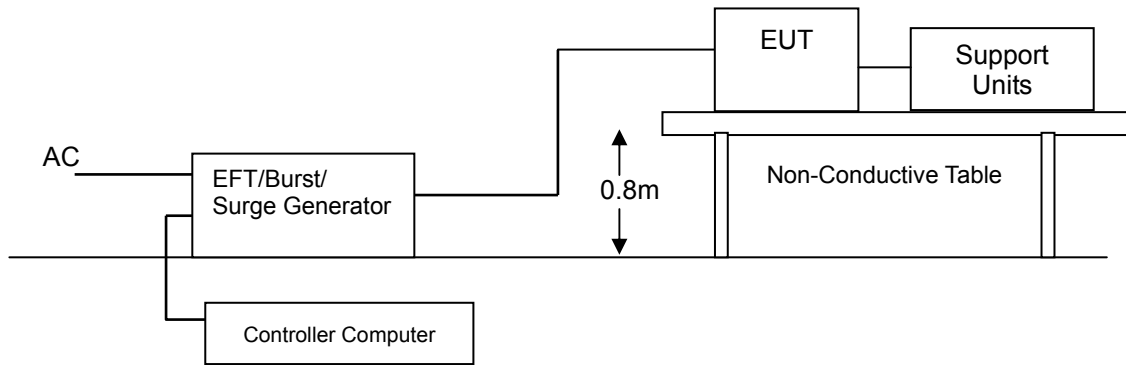

For the actual test configuration, please refer to the related item – Photographs of the Test Configuration.

**NOTE:**

TABLETOP EQUIPMENT

The configuration consisted of a wooden table (0.8m high) standing on the Ground Reference Plane. The GRP consisted of a sheet of aluminum (at least 0.25mm thick and 2.5m square) connected to the protective grounding system. A minimum distance of 0.5m was provided between the EUT and the walls of the laboratory or any other metallic structure.

FLOOR STANDING EQUIPMENT

The EUT installed in a representative system as described in section 7 of IEC 61000-4-4 and its cables, were isolated from the Ground Reference Plane by an insulating support that is 0.1-meter thick. The GRP consisted of a sheet of aluminum (at least 0.25mm thick and 2.5m square) connected to the protective grounding system.

#### 9.5.4. TEST RESULTS

|                              |                   |
|------------------------------|-------------------|
| Temperature ( °C )           | 22~28             |
| Humidity ( %RH )             | 50~58             |
| Barometric Pressure ( mbar ) | 950~1000          |
| EUT                          | TRACK ACCESSORIES |
| M/N                          | 9945              |
| Operating Mode               | Normal Operating  |
| Test Results                 | PASS              |

| Test Point     | Polarity | Test Level (kV) | Performance Criterion | Observation   | Result |
|----------------|----------|-----------------|-----------------------|---|--------|
| L 1            | +/-      | 1               | B                     | Note <input type="checkbox"/> 1 <input checked="" type="checkbox"/> 2 | PASS   |
| L 2            | +/-      | 1               | B                     | Note <input type="checkbox"/> 1 <input checked="" type="checkbox"/> 2 | PASS   |
| L 1-L 2        | +/-      | 1               | B                     | Note <input type="checkbox"/> 1 <input checked="" type="checkbox"/> 2 | PASS   |
| PE             | +/-      | 1               | B                     | Note <input type="checkbox"/> 1 <input checked="" type="checkbox"/> 2 | N/A    |
| L – PE         | +/-      | 1               | B                     | Note <input type="checkbox"/> 1 <input checked="" type="checkbox"/> 2 | N/A    |
| N – PE         | +/-      | 1               | B                     | Note <input type="checkbox"/> 1 <input checked="" type="checkbox"/> 2 | N/A    |
| L – N – PE     | +/-      | 1               | B                     | Note <input type="checkbox"/> 1 <input checked="" type="checkbox"/> 2 | N/A    |
| RJ45 UTP cable | --       | --              | --                    | Note <input type="checkbox"/> 1 <input type="checkbox"/> 2            | N/A    |

- NOTE:** 1. There was no change compared with initial operation during the test.  
 2. The loss of function of the EUT during the test and it was recovered by itself operation after the test.

## 9.6. SURGE IMMUNITY TEST

### 9.6.1 TEST SPECIFICATION

|                                    |  |
|------------------------------------|--|
| <b>Basic Standard:</b>             | EN 61000-4-5   |
| <b>Wave-Shape:</b>                 | Combination Wave<br>1.2/50 us Open Circuit Voltage<br>8/20 us Short Circuit Current      |
| <b>Test Voltage:</b>               | Power line ~ line to line: 1 kV;<br>line to ground: 2kV<br>Telecommunication line: 1 kV; |
| <b>Surge Input/Output:</b>         | Power Line: L-N/ N-PE / L-PE<br>Telecommunication line: T-Ground / R-Ground              |
| <b>Generator Source Impedance:</b> | 2 ohm between networks<br>12 ohm between network and ground                              |
| <b>Polarity:</b>                   | Positive/Negative  |
| <b>Phase Angle:</b>                | 90/ 270  |
| <b>Pulse Repetition Rate:</b>      | 1 time / min. (maximum)  |
| <b>Number of Tests:</b>            | 5 positive and 5 negative at selected points   |
| <b>Performance Criterion:</b>      | B  |

### 9.6.2. TEST PROCEDURE

a) For EUT power supply:

The surge is applied to the EUT power supply terminals via the capacitive coupling network. Decoupling networks are required in order to avoid possible adverse effects on equipment not under test that may be powered by the same lines, and to provide sufficient decoupling impedance to the surge wave. The power cord between the EUT and the coupling/decoupling networks was shorter than 2 meters in length.

b) For test applied to unshielded un-symmetrically operated interconnection lines of EUT:

The surge was applied to the lines via the capacitive coupling. The coupling / decoupling networks didn't influence the specified functional conditions of the EUT. The interconnection line between the EUT and the coupling/decoupling networks was shorter than 2 meters in length.

c) For test applied to unshielded symmetrically operated interconnection / telecommunication lines of EUT:

The surge was applied to the lines via gas arrestors coupling. Test levels below the ignition point of the coupling arrestor were not specified. The interconnection line between the EUT and the coupling/decoupling networks was shorter than 2 meters in length.

### 9.6.3. TEST SETUP

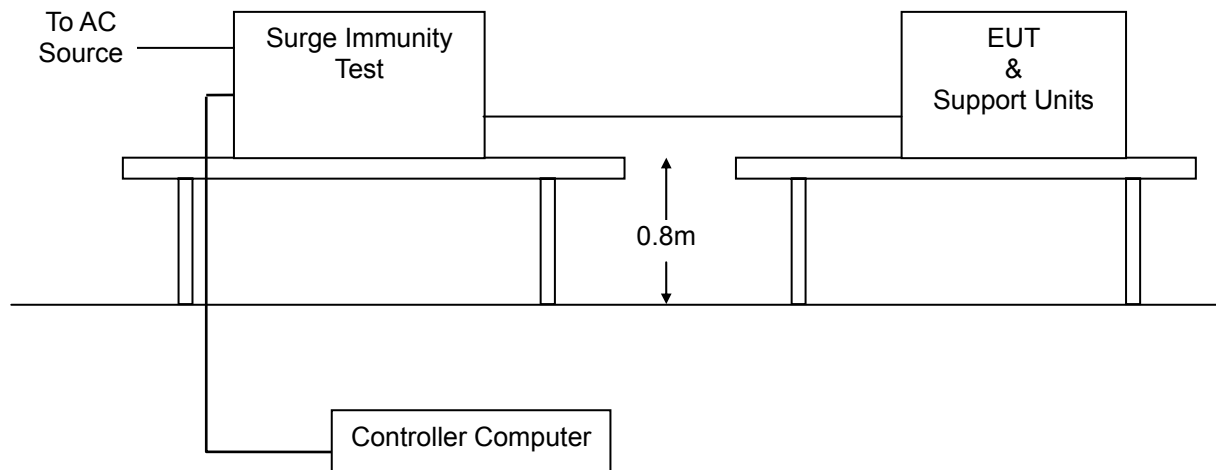

For the actual test configuration, please refer to the related item – Photographs of the Test Configuration.

### 9.6.4. TEST RESULTS

|                              |                   |
|------------------------------|-------------------|
| Temperature ( °C )           | 22~28             |
| Humidity ( %RH )             | 50~58             |
| Barometric Pressure ( mbar ) | 950~1000          |
| EUT                          | TRACK ACCESSORIES |
| M/N                          | 9945              |
| Operating Mode               | Normal Operating  |
| Test Results                 | PASS              |

| Test Point | Polarity | Test Level (kV) | Performance Criterion | Observation   | Result |
|------------|----------|-----------------|-----------------------|---|--------|
| L - N      | +/-      | 0.5             | B                     | Note <input type="checkbox"/> 1 <input checked="" type="checkbox"/> 2 | PASS   |
| L - PE     | /        | /               | /                     | Note <input type="checkbox"/> 1 <input type="checkbox"/> 2            | N/A    |
| N - PE     | /        | 1               | /                     | Note <input type="checkbox"/> 1 <input type="checkbox"/> 2            | N/A    |
| R - Ground | /        | /               | /                     | Note <input type="checkbox"/> 1 <input type="checkbox"/> 2            | N/A    |
| T - Ground | /        | /               | /                     | Note <input type="checkbox"/> 1 <input type="checkbox"/> 2            | N/A    |

**NOTE:** 1. There was no change compared with initial operation during the test.  
 2. The loss of function of the EUT during the test and it was recovered by itself operation after the test.

## 9.7. CONDUCTED RADIO FREQUENCY DISTURBANCES (CS)

### 9.7.1. TEST SPECIFICATION

|                               |                                    |
|-------------------------------|------------------------------------|
| <b>Basic Standard:</b>        | EN 61000-4-6                       |
| <b>Frequency Range:</b>       | 0.15 MHz ~ 80 MHz                  |
| <b>Field Strength:</b>        | 3 V                                |
| <b>Modulation:</b>            | 1kHz Sine Wave, 80%, AM Modulation |
| <b>Frequency Step:</b>        | 1 % of preceding frequency value   |
| <b>Coupled cable:</b>         | Power Mains, Shielded              |
| <b>Coupling device:</b>       | CDN-M3/2 (3 wires)                 |
| <b>Performance Criterion:</b> | A                                  |

### 9.7.2. TEST PROCEDURE

The EUT shall be tested within its intended operating and climatic conditions.

The test shall be performed with the test generator connected to each of the coupling and decoupling devices in turn, while the other non-excited RF input ports of the coupling devices are terminated by a 50-ohm load resistor.

The frequency range was swept from 150 kHz to 80 MHz, using the signal level established during the setting process and with a disturbance signal of 80 % amplitude. The signal was modulated with a 1 kHz sine wave, pausing to adjust the RF signal level or the switch coupling devices as necessary. The sweep rate was  $1.5 \times 10^{-3}$  decades/s. Where the frequency range is swept incrementally, the step size was 1 % of preceding frequency value from 150 kHz to 80 MHz.

The dwell time at each frequency was less than the time necessary for the EUT to be exercised, and able to respond. Sensitive frequencies such as clock frequency(ies) and harmonics or frequencies of dominant interest, was analyzed separately.

Attempts were made to fully exercise the EUT during testing, and to fully interrogate all exercise modes selected for susceptibility.

### 9.7.3. TEST SETUP

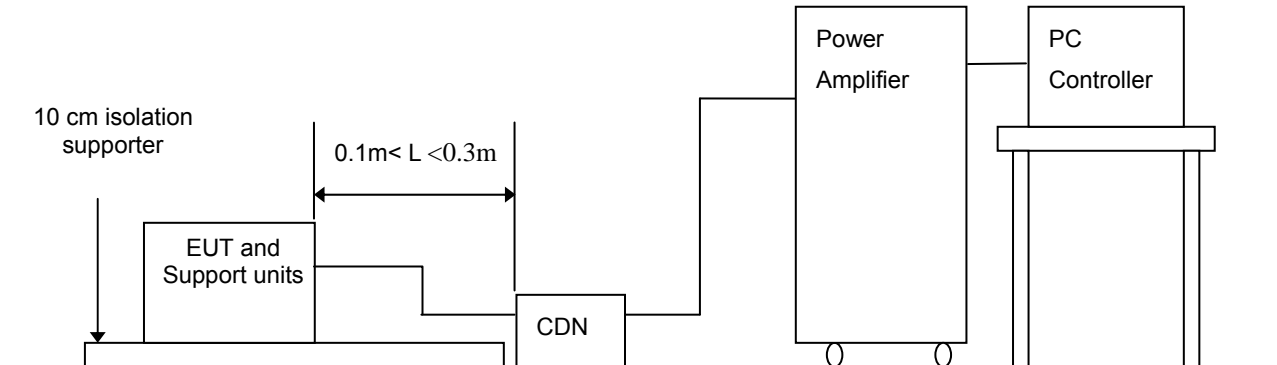

- Note:** 1. The EUT is setup 0.1m above Ground Reference Plane  
 2. The CDNS and / or EM clamp used for real test depends on ports and cables configuration of EUT.

For the actual test configuration, please refer to the related item.

**NOTE:**

TABLE-TOP AND FLOOR-STANDING EQUIPMENT

The equipment to be tested is placed on an insulating support of 0.1 meters height above a ground reference plane. All relevant cables shall be provided with the appropriate coupling and decoupling devices at a distance between 0.1 meters and 0.3 meters from the projected geometry of the EUT on the ground reference plane.

### 9.7.4. TEST RESULTS

|                              |                   |
|------------------------------|-------------------|
| Temperature ( °C )           | 22~28             |
| Humidity ( %RH )             | 50~58             |
| Barometric Pressure ( mbar ) | 950~1000          |
| EUT                          | TRACK ACCESSORIES |
| M/N                          | 9945              |
| Operating Mode               | Normal Operating  |
| Test Results                 | PASS              |

| Frequency Band (MHz) | Field Strength (Vrms) | Injected Position | Injection Method | Performance Criterion | Observation   | Result |
|----------------------|-----------------------|-------------------|------------------|-----------------------|---|--------|
| 0.15 ~ 80            | 3                     | AC Mains          | CDN-M3           | A                     | Note <input checked="" type="checkbox"/> 1 <input type="checkbox"/> 2 | PASS   |
| 0.15 ~ 80            | 3                     | N/A               |                  |                       | Note <input type="checkbox"/> 1 <input type="checkbox"/> 2            | N/A    |

- NOTE:** 1. There was no change compared with initial operation during the test.  
 2. The loss of function of the EUT during the test and it was recovered by itself operation after the test.



## 9.8. POWER FREQUENCY MAGNETIC FIELD

### 9.8.1. TEST SPECIFICATION

|                               |                         |
|-------------------------------|-------------------------|
| <b>Basic Standard:</b>        | EN 61000-4-8            |
| <b>Frequency Range:</b>       | 50Hz,                   |
| <b>Field Strength:</b>        | 3A/m                    |
| <b>Observation Time:</b>      | 5 minutes               |
| <b>Inductance Coil:</b>       | Rectangular type, 1mx1m |
| <b>Performance Criterion:</b> | A                       |

### 9.8.2. TEST PROCEDURE

- a) The equipment is configured and connected to satisfy its functional requirements. It shall be placed on the GRP with the interposition of a 0.1m-thick insulating support.
- b. The equipment cabinets shall be connected to the safety earth directly on the GRP via the earth terminal of the EUT.
- c. The power supply, input and output circuits shall be connected to the sources of power supply, control and signal.
- d. The cables supplied or recommended by the equipment manufacturer shall be used. 1 meter of all cables used shall be exposed to the magnetic field.

### 9.8.3. TEST SETUP

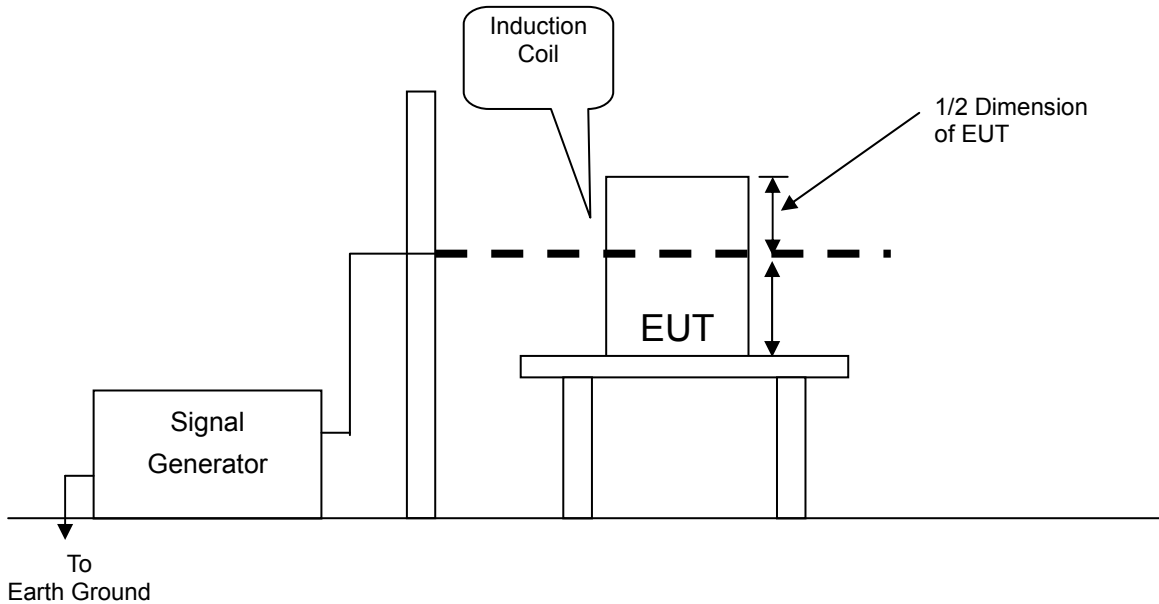

For the actual test configuration, please refer to the related item.

#### NOTE:

##### TABLETOP EQUIPMENT

The equipment shall be subjected to the test magnetic field by using the induction coil of standard dimension (1 m x 1 m). The induction coil shall then be rotated by 90 degrees in order to expose the EUT to the test field with different orientations.

##### FLOOR-STANDING EQUIPMENT

The equipment shall be subjected to the test magnetic field by using induction coils of suitable dimensions. The test shall be repeated by moving and shifting the induction coils, in order to test the whole volume of the EUT for each orthogonal direction. The test shall be repeated with the coil shifted to different positions along the side of the EUT, in steps corresponding to 50 % of the shortest side of the coil. The induction coil shall then be rotated by 90 degrees in order to expose the EUT to the test field with different orientations.

### 9.8.4. TEST RESULTS

|                              |                   |
|------------------------------|-------------------|
| Temperature ( °C )           | 22~28             |
| Humidity ( %RH )             | 50~58             |
| Barometric Pressure ( mbar ) | 950~1000          |
| EUT                          | TRACK ACCESSORIES |
| M/N                          | 9945              |
| Operating Mode               | Normal Operating  |
| Test Results                 | PASS              |

| DIRECTION | Field Strength (A/m) | Performance Criterion | OBSERVATION   | RESULTS |
|-----------|----------------------|-----------------------|---|---------|
| X         | 3                    | A                     | Note <input checked="" type="checkbox"/> 1 <input type="checkbox"/> 2 | PASS    |
| Y         | 3                    | A                     | Note <input checked="" type="checkbox"/> 1 <input type="checkbox"/> 2 | PASS    |
| Z         | 3                    | A                     | Note <input checked="" type="checkbox"/> 1 <input type="checkbox"/> 2 | PASS    |

**NOTE:** 1. There was no change compared with initial operation during the test.  
 2. The loss of function of the EUT during the test and it was recovered by itself operation after the test.

## 9.9. VOLTAGE DIP & VOLTAGE INTERRUPTIONS

### 9.9.1. TEST SPECIFICATION

|                                |   |
|--------------------------------|---|
| <b>Basic Standard:</b>         | EN 61000-4-11                                   |
| <b>Test Duration Time:</b>     | Minimum three test events in sequence           |
| <b>Interval Between Event:</b> | Minimum 10 seconds                              |
| <b>Phase Angle:</b>            | 0 / 45 / 90 / 135 / 180 / 225 / 270 / 315 / 360 |
| <b>Test Cycle:</b>             | 3 times   |
| <b>Performance Criterion:</b>  | B,C   |

### 9.9.2. TEST PROCEDURE

1. The EUT and support units were located on a wooden table, 0.8 m away from ground floor.
2. Setting the parameter of tests and then perform the test software of test simulator.
3. Conditions changes to occur at 0 degree crossover point of the voltage waveform.
4. Recording the test result in test record form.

### 9.9.3. TEST SETUP

For the actual test configuration, please refer to the related item – Photographs of the Test Configuration.

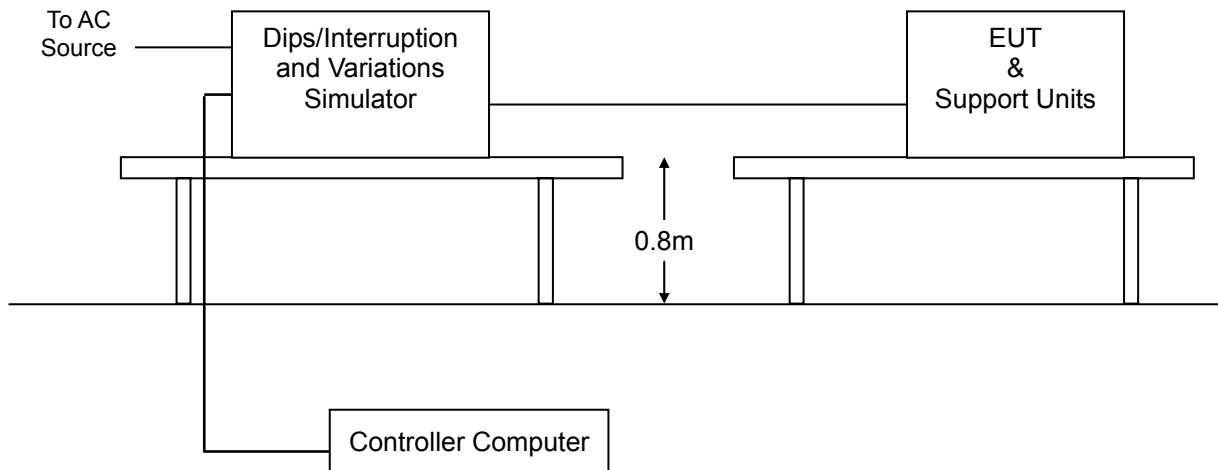

#### 9.9.4. TEST RESULTS

|                              |                   |
|------------------------------|-------------------|
| Temperature ( °C )           | 22~28             |
| Humidity ( %RH )             | 50~58             |
| Barometric Pressure ( mbar ) | 950~1000          |
| EUT                          | TRACK ACCESSORIES |
| M/N                          | 9945              |
| Operating Mode               | Normal Operating  |
| Test Results                 | PASS              |

| Test Power: 230Vac, 50Hz |                   |                            |  |  |             |
|--------------------------|-------------------|----------------------------|--|--|-------------|
| Voltage (% Reduction)    | Duration (Period) | Performance Criterion      |  | Observation  | Test Result |
| 100                      | 0.5               | <input type="checkbox"/> A | <input checked="" type="checkbox"/> B <input type="checkbox"/> C | Note <input type="checkbox"/> 1 <input checked="" type="checkbox"/> 2 <input type="checkbox"/> 3 | PASS        |
| 30                       | 10                | <input type="checkbox"/> A | <input type="checkbox"/> B <input checked="" type="checkbox"/> C | Note <input type="checkbox"/> 1 <input type="checkbox"/> 2 <input checked="" type="checkbox"/> 3 | PASS        |

- NOTE:** 1. There was no change compared with initial operation during and after the test.  
 No unintentional response was found during the test.  
 2. The function stopped during the test, but can be recoverable by itself operation after the test.  
 3. The function stopped during the test, but can be recoverable manually after the test.

## 10. TEST SETUP PHOTOGRAPHS

### CONDUCTED EMISSION TEST



### RADIATED EMISSION TEST

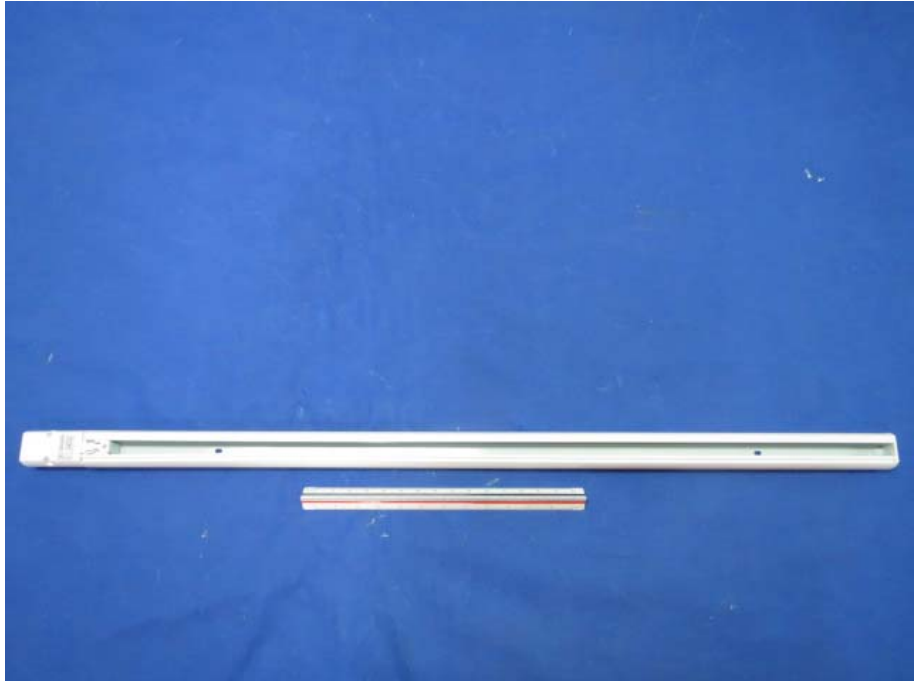

## 11. PHOTOGRAPHS OF EUT

|  |   |
|--|---|
| <p>Photo 1</p> <p>View:</p> <p><input checked="" type="checkbox"/> Front</p> <p><input type="checkbox"/> Rear</p> <p><input type="checkbox"/> Right side</p> <p><input type="checkbox"/> Left side</p> <p><input type="checkbox"/> Top</p> <p><input type="checkbox"/> Bottom</p> <p><input type="checkbox"/> Internal</p> |  |
|--|---|

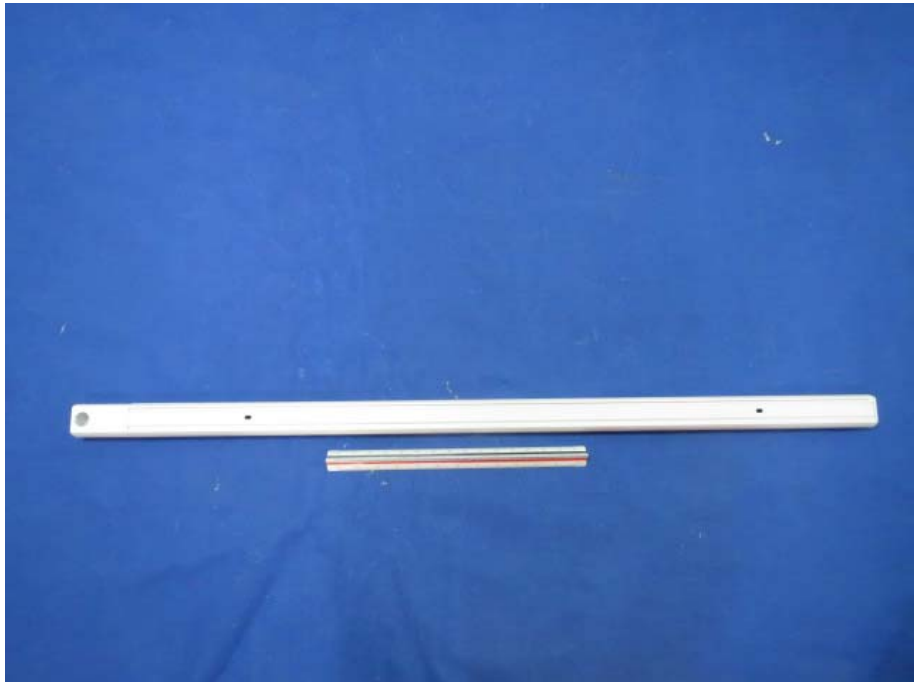
|  |  |
|--|--|
| <p>Photo 2</p> <p>View:</p> <p><input type="checkbox"/> Front</p> <p><input checked="" type="checkbox"/> Rear</p> <p><input type="checkbox"/> Right side</p> <p><input type="checkbox"/> Left side</p> <p><input type="checkbox"/> Top</p> <p><input type="checkbox"/> Bottom</p> <p><input type="checkbox"/> Internal</p> |  |
|--|--|

|  |  |
|--|--|
| <p>Photo 3</p> <p>View:</p> <p><input type="checkbox"/> Front</p> <p><input type="checkbox"/> Rear</p> <p><input type="checkbox"/> Right side</p> <p><input type="checkbox"/> Left side</p> <p><input type="checkbox"/> Top</p> <p><input type="checkbox"/> Bottom</p> <p><input checked="" type="checkbox"/> Internal</p> |  |
|--|--|

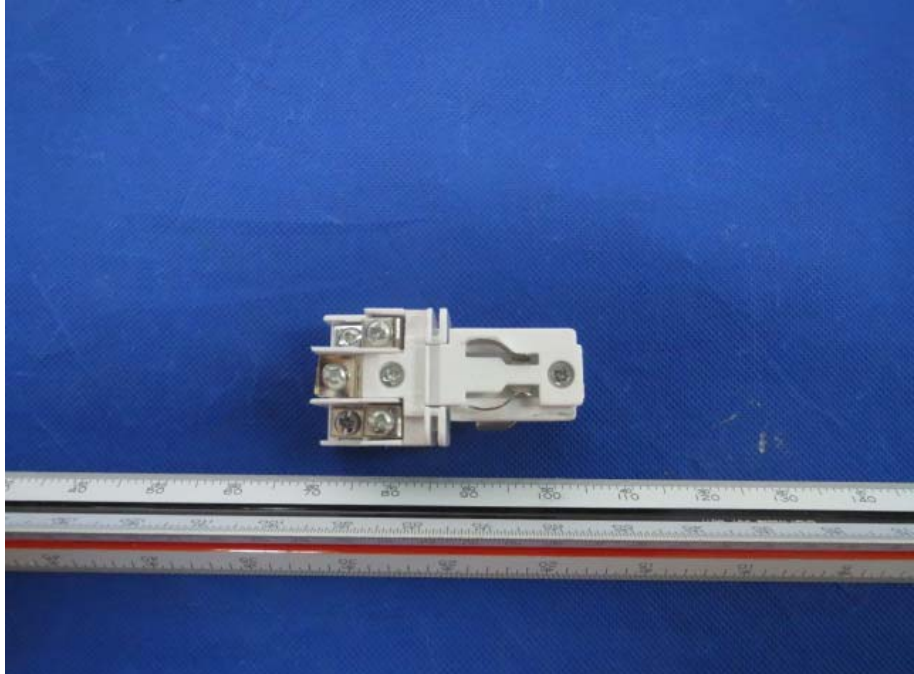
|  |  |
|--|--|
| <p>Photo 4</p> <p>View:</p> <p><input type="checkbox"/> Front</p> <p><input type="checkbox"/> Rear</p> <p><input type="checkbox"/> Right side</p> <p><input type="checkbox"/> Left side</p> <p><input type="checkbox"/> Top</p> <p><input type="checkbox"/> Bottom</p> <p><input checked="" type="checkbox"/> Internal</p> |  |
|--|--|

---END---