

INSTALLATION INSTRUCTION

VT-4536
LED TRACK LIGHT



INTRODUCTION

Thank you for selecting and buying V-TAC LED product. V-TAC will serve you the best. Please read these instructions carefully before starting the installing and keep this manual handy for future reference. If you have any other query, please contact our dealer or local vendor from whom you have purchased the product. They are trained and ready to serve you at the best.

STRUCTURE AND SIZE

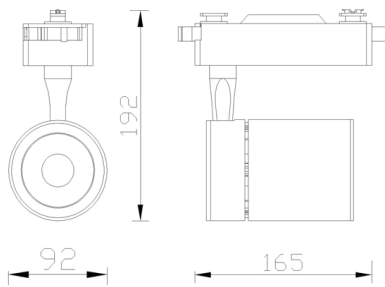
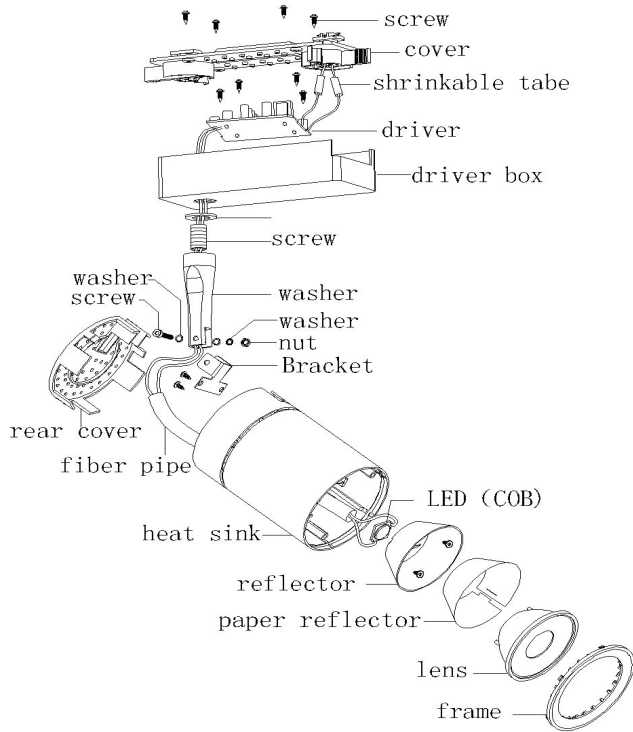

INSTALLATION INSTRUCTION

Installation instructions:

1. Switch off the power.
2. Install track in the ceiling solidly. (see below pic.1)
3. Connect the track to mains(220V-240V) in a correct way. (see below pic.2)
4. Turn adaptor slide switch. (see below pic.3)
5. Fix the lamp into track(see below pic.4), lift up the lamp and turn adaptor slide switch. (see below pic.5)
6. Switch on the power if above steps done properly without any mistakes.

1



2



3



5



4

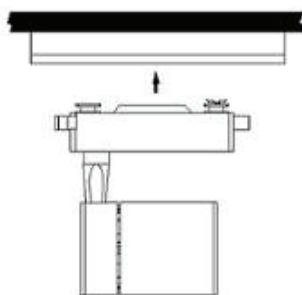



NOTICE

- Risk of shock, hence disconnect at fuse or circuit breaker before installation or servicing.
- Suitable for a Maximum use of 10-20 Hours Daily. Usage of product for 24Hours a day would void the warranty.

WARRANTY

- This product is warranted from manufacturing defect only.
- The warranty does not apply to damage caused by incorrect installation or abnormal wear and tear.
- The company gives no warranty against damage to any surface due to incorrect removal and installation of the product.

WARNING

- The product uses a very high power LED. As with any light source, direct viewing should be avoided.
- NOTE: Although easy to fit, this lamp requires wiring to the main and for safety should only be fitted by a qualified electrician.
- Having issued this warning, the company accepts no responsibility for issues arising for any failures to comply with these clear instructions.
- The company will not accept any responsibility for any other issues arising from improper use of fitting of this product as these materials are beyond our control.