



## **All-in-One ESS (LV)**

**RW-F5.3-1H3**

**RW-F5.3-2H3**

## **USER MANUAL**



# Contents

1.Safety Introductions .....	1
2.Product Introduction .....	3
3.Specifications .....	3
4.Unpacking Guide .....	5
5.Packing List .....	5
5.1 Parts List .....	5
5.2 Product handling requirements .....	6
5.3 Installations Tools .....	6
6.Security Introduction .....	7
6.1 Preparation Before Connection .....	7
6.2 In Use .....	8
7.Quick Guide .....	9
7.1 Product Dimensions .....	9
7.2 Operation Interface .....	10
7.3 Display ICONS .....	11
8.Mechanical Installation .....	12
8.1 Considering the following points before selecting where to install: .....	12
8.2 Mounting the ESS .....	12
8.3 Function port definition .....	14
8.3.1 Interface definition .....	15
8.4 Grid connection and backup load connection .....	19
8.5 PV Connection .....	21
8.5.1 PV Module Selection: .....	21
8.5.2 PV Module Wire Connection: .....	21
8.6 CT Connection .....	24
8.7 Meter Connection .....	25
8.8 Earth Connection (mandatory) .....	26
9.Product Wiring Instructions .....	27
9.1 Cables for Battery Expansion .....	27
9.2 Parallel Capacity Expansion .....	27
9.3 Typical Application Diagram of Diesel Generator .....	28
9.4 Single Phase Parallel Connection Diagram .....	29
9.5 Three Phase Parallel Inverter .....	30
9.6 Wiring System for Inverter .....	31
10.Activation product .....	32
11.LCD Display Icons .....	33
11.1 Main Screen .....	33
11.1.1 LCD Operation Flow Chart .....	34
11.2 Solar Power Curve .....	35
11.2 Curve Page-Solar & Load & Grid .....	36
11.3 System Setup Menu .....	37
11.4 Basic Setup Menu .....	37
11.5 Battery Setup Menu .....	38
11.6 System Work Mode Setup Menu .....	40
11.7 Grid Setup Menu .....	42
11.8 The Method of CEI-021 Standard Self-Check .....	44
11.9 Generator Port Use Setup Menu .....	46
11.10 Advanced Function Setup Menu .....	47
11.11 Device Info Setup Menu .....	48
12.Fault Content .....	49
12.1 Fault Information and Processing .....	49
12.2 Low Voltage Fault Analysis Method .....	49
13.FAQ .....	54
14.After-Sales Service .....	55
15.EU Declaration of Conformity .....	55

## About This Manual

The manual mainly describes the product information, guidelines for installation, operation and maintenance. The manual cannot include complete information about the photovoltaic (PV) system.







## How to Use This Manual

Read the manual and other related documents before performing any operation on the inverter. Documents must be stored carefully and be available at all times.

Contents may be periodically updated or revised due to product development. The information in this manual is subject to change without notice. The latest manual can be acquired via [service@deye.com.cn](mailto:service@deye.com.cn)

# 1.Safety Introductions

## Labels description

Label	Description
	Caution, risk of electric shock symbol indicates important safety instructions, which if not correctly followed, could result in electric shock.
	The DC input terminals of the inverter must not be grounded.
	Surface high temperature, Please do not touch the inverter case.
	The AC and DC circuits must be disconnected separately, and the maintenance personnel must wait for 5 minutes before they are completely powered off before they can start working.
	CE mark of conformity
	Please read the instructions carefully before use.
	Symbol for the marking of electrical and electronics devices according to Directive 2002/96/EC. Indicates that the device, accessories and the packaging must not be disposed as unsorted municipal waste and must be collected separately at the end of the usage. Please follow Local Ordinances or Regulations for disposal or contact an authorized representative of the manufacturer for information concerning the decommissioning of equipment.

- This chapter contains important safety and operating instructions. Read and keep this manual for future reference.
- Before using the inverter, please read the instructions and warning signs of the battery and corresponding sections in the instruction manual. Do not disassemble the inverter. If you need maintenance or repair, take it to a professional service center.
- Improper reassembly may result in electric shock or fire.
- To reduce risk of electric shock, disconnect all wires before attempting any maintenance or cleaning. Turning off the unit will not reduce this risk.
- Caution: Only qualified personnel can install this device with battery.
- Never charge a frozen battery.
- For optimum operation of this inverter, please follow required specification to select appropriate cable size. It is very important to correctly operate this inverter.
- Be very cautious when working with metal tools on or around batteries. Dropping a tool may cause a spark or short circuit in batteries or other electrical parts, even cause an explosion. Please strictly follow installation procedure when you want to disconnect AC or DC terminals. Please refer to "installation" section of this manual for the details.
- Grounding instructions - this inverter should be connected to a permanent grounded wiring system. Be sure to comply with local requirements and regulation to install this inverter. Never cause AC output and DC input short circuited. Do not connect to the mains when DC input short circuits.

## 2.Product Introduction

This is an all-in-one hybrid inverter Energy storage system, combining functions of inverter, solar charger and LFP battery to offer uninterruptible power support with portable size. its comprehensive LCD display offers user configurable and easy accessible button operation such as battery charging, AC/solar charging, and acceptable input voltage based on different applications.

## 3.Specifications

Model	RW-F5.3-2H3	RW-F5.3-1H3
AC Technical Specification		
Rated AC Input/Output Active Power (W)	3600 / 3600	5000 / 5000
Max AC Input/Output Apparent Power (VA)	3960	5500
Peak Power (off grid)	2 time of rated power, 10s	
Rated AC Input/Output Current (A)	16.4/15.7	22.8/21.8
Max. AC Input/Output Current (A)	18/17.3	25/24
Max Continuous AC Passthrough (grid to load) (A)	35	
Rated Input/Output Voltage/Range (V)	220V/230, 0.85Un-1.1Un	
Grid Connection Form	L+N+PE	
Rated Input/Output Grid Frequency/Range	50Hz/45Hz-55Hz, 60Hz/55Hz-65Hz	
Power Factor Adjustment Range	0.8 leading to 0.8 lagging	
Total Harmonic Distortion (THD)	<3% (of nominal power)	
DC Technical Specification		
Max. PV Access Power (W)	7200	10000
Max. PV Input Power (W)	5760	8000
Max. PV Input Voltage (Vdc)	500	
Start Up PV Voltage (Vdc)	125	
MPPT Voltage Range (Vdc)	150 to 425	
Full Load MPPT Voltage Range (Vdc)	300 to 425	
Rated PV Input Voltage (Vdc)	370	
Max. Operating PV Input Current (A)	18+18	
Max. PV Input Short-circuit Current (A)	27+27	
Number of MPP Trackers	2	
No. of Strings Per MPP Tracker	1 + 1	
Battery Chemistry	LiFePO4	
Battery Nominal Voltage (V)	51.2	
Battery Energy Configuration (kWh)	5.32	

Max. Charging/Discharging Current (A)	75	100
Battery Operating Voltage (V)	44.8 to 57.6	
Battery Cycle Life	≥6000(@25°C±2°C,0.5C/0.5C,70%EOL)	
<b>General Technical Specification</b>		
Dimension (W x D x H,mm)	616 × 191 × 690 (Excluding connectors and brackets)	
Weight Appr. (kg)	71	
Ingress Protection(IP) Rating	IP65	
Operating Temperature Range	-10°C to 55°C (>45°C derating)	
Permissible Ambient Humidity	0 to 100%	
Permissible Altitude	2000m	
Inverter Topology	Non-Isolated	
Over Voltage Category	OVC II(DC),OVC III(AC)	
Pollution degree (PD)	PD3	
Type Of Cooling	Natural Cooling	
Noise(dB)	<30	
Display	Touch LCD	
Monitor Mode	WIFI, Bluetooth	
Installation Style	Wall-Mounted, Floor-Mounted	
Max. Efficiency	97%	
Max. charging/discharging Efficiency	95.5%	
MPPT Efficiency	>99%	
Safety EMC / Standard	IEC/EN 61000-6-1/2/3/4, IEC/EN 62109-1, IEC/EN 62109-2, IEC62619, UN38.3	
Grid Regulation	IEC 61727,IEC 62116,CEI 0-21,EN 50549,NRS 097,RD 140, UNE 217002,OVE-Richtlinie R25,G99,VDE-AR-N 4105	
Warranty	5/10 years (the Warranty Period Depends the Final Installation Site.More Info Please Refer to Warranty Policy)	

## 4.Unpacking Guide

### Check the outer packing

Before unpacking the outer package, check the outer package for visible damage, such as holes, cracks, or other signs of possible internal damage, and check the energy storage model. If there is any abnormal packaging or energy storage model does not match, do not open, and contact your dealer as soon as possible.

### Check deliverables

After unpacking the outer packaging of the energy storage, check that the deliverables are complete and there is no obvious external damage. If anything is missing or damaged, contact your dealer.

**Note:** For the quantity of deliverables shipped with the box, please refer to the Packing List in the box.

## 5.Packing List

### 5.1 Parts List

Check the equipment before installation. Please make sure nothing is damaged in the package.You should have received the items in the following package:

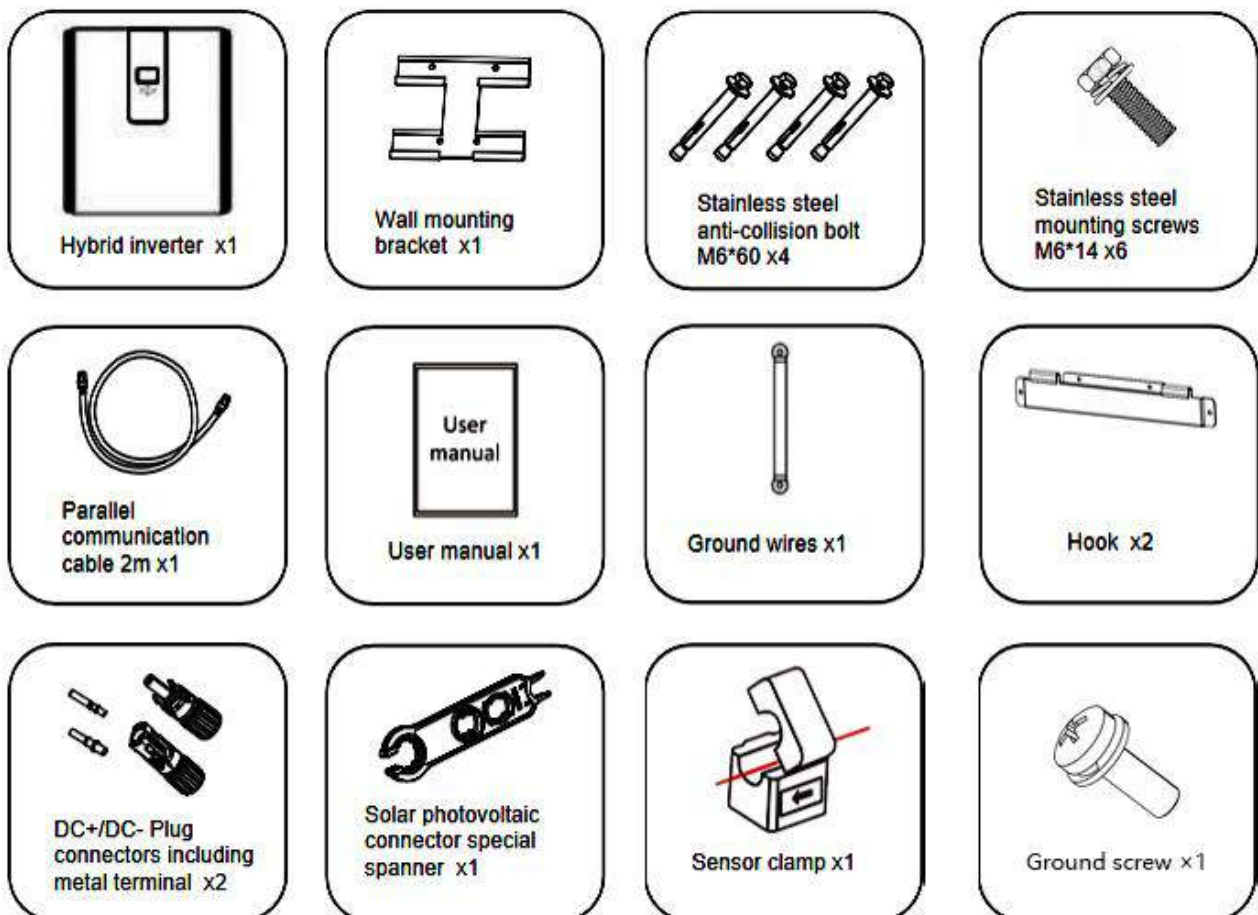

## 5.2 Product handling requirements

Lift the inverter out of the packing box and transport it to designated installation location.

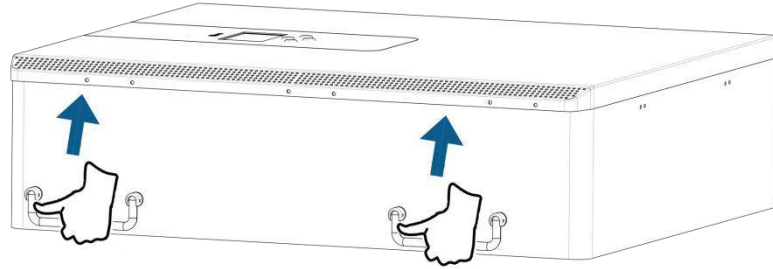

CAUTION:

- Improper handling may cause personal injury!
- Arrange an appropriate number of personnel to carry the inverter according to its weight, and installation personnel should wear protective equipment such as anti-impact shoes and gloves.
- Placing the inverter directly on a hard ground may cause damage to its metal enclosure. Protective materials such as sponge pad or foam cushion should be placed underneath the inverter.
- Move the inverter by one or two people or by using a proper transport tool.
- Move the inverter by holding the handles on it. Do not move the inverter by holding the terminals.

## 5.3 Installations Tools

Installation tools can refer to the following recommended ones. Also, use other auxiliary tools on site.





## 6.Security Introduction



### Warning

1. It is very important and necessary to read the user manual (attached) carefully before installing or using the battery. Failure to do so or to follow any instructions or warnings in this document may result in electric shock, serious injury, or possible damage to the battery, rendering it inoperable.
2. If the battery is stored for a long time, it is recommended to charge the product once a month or So, and the Soc should not be less than 50% .
3. Charge the battery within 48 hours after it is fully discharged.
4. Do not expose the cable.
5. Disconnect all power supplies during maintenance.
6. If any exception occurs, please contact the supplier within 24 hours.
7. Do not use cleaning solvents to clean the battery.
8. Do not expose this product to flammable or irritating chemicals or vapors.
9. It is prohibited to paint any part of this product, including any internal or external components.
10. Direct or indirect damages caused by the above reasons do not include warranty claims.
11. Do not insert any foreign matter into any part of the product.



### Warning

## 6.1 Preparation Before Connection

1. After unpacking, please check the product and packing list. If the product is damaged or missing, please contact the local retailer.
2. Before installation , disconnect the power supply from the power grid and ensure that the battery is turned off.
3. Cables must be connected correctly and do not short-circuit external devices.
4. Keep away from fire.
5. Do not use non-official parts or accessories.
6. Do not stack other heavy objects on the product.

## 6.2 In Use

1. If you need to move or repair the product, you must disconnect the power supply and completely turn off the product.
2. Do not connect batteries of different models.
3. Disassembly is prohibited.
4. In case of fire, only liquid fire extinguishers can be used. Dry fire extinguishers are prohibited.
5. Please AVOID direct sunlight, rain exposure, snow laying up during installation and operation.

Before connecting all wires, please take off the metal cover by removing screws as shown below:

- Remove the three screws pointed by the arrow.
- Open the three latches to open the lid of the product.

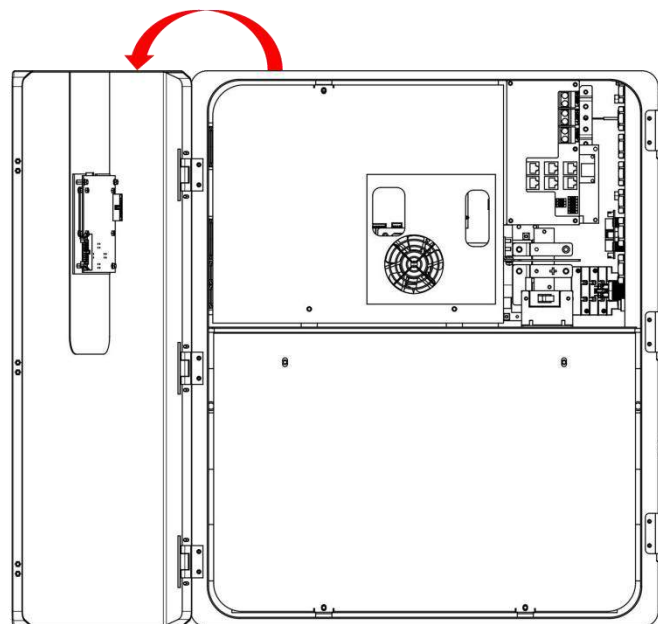
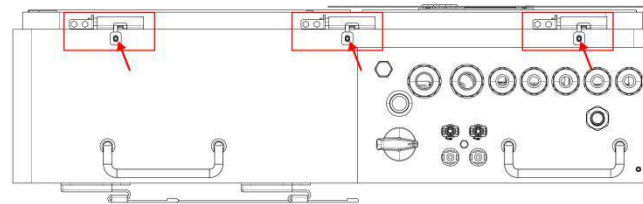

## 7.Quick Guide

### 7.1 Product Dimensions

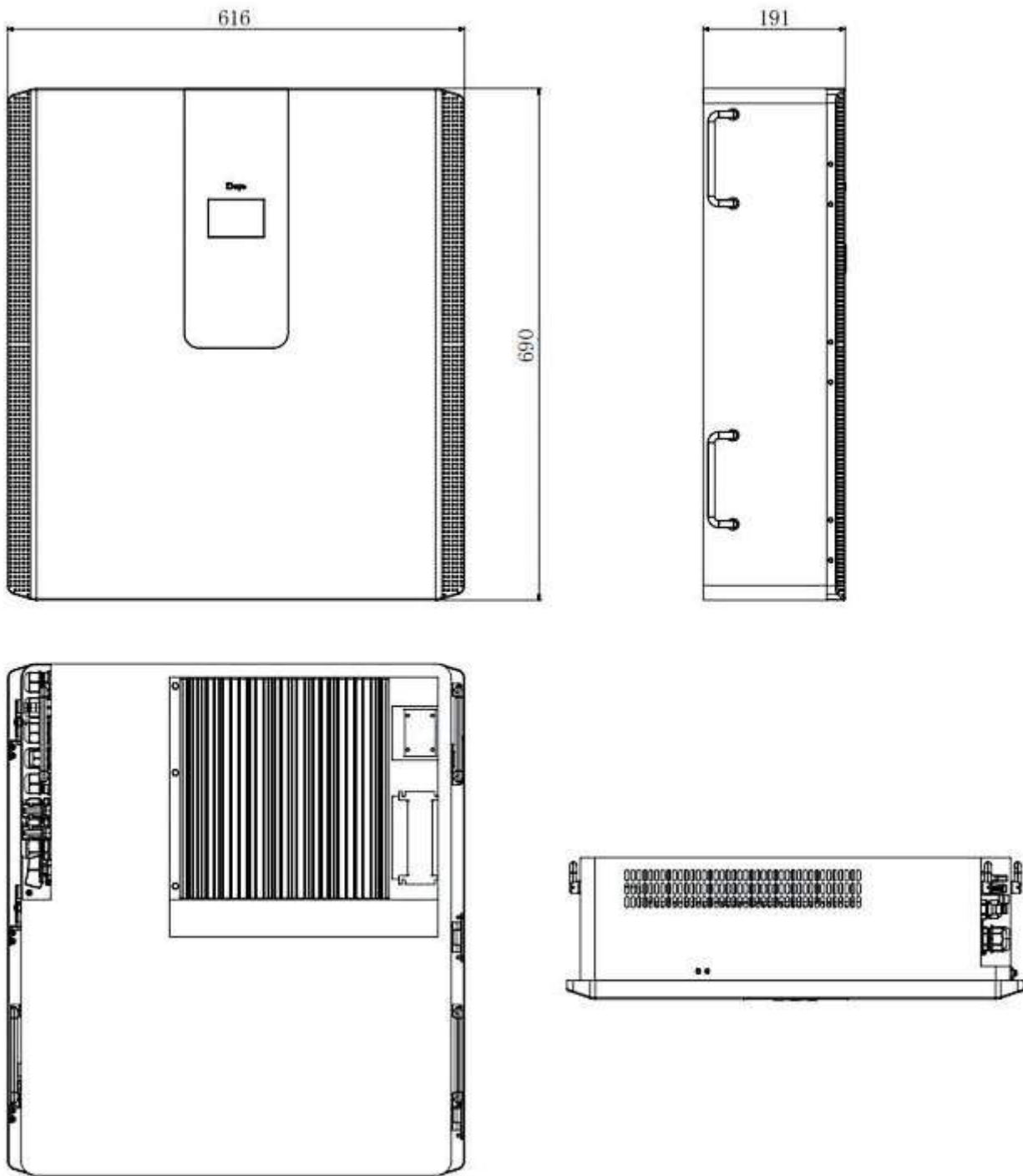

Unit: mm

## 7.2 Operation Interface

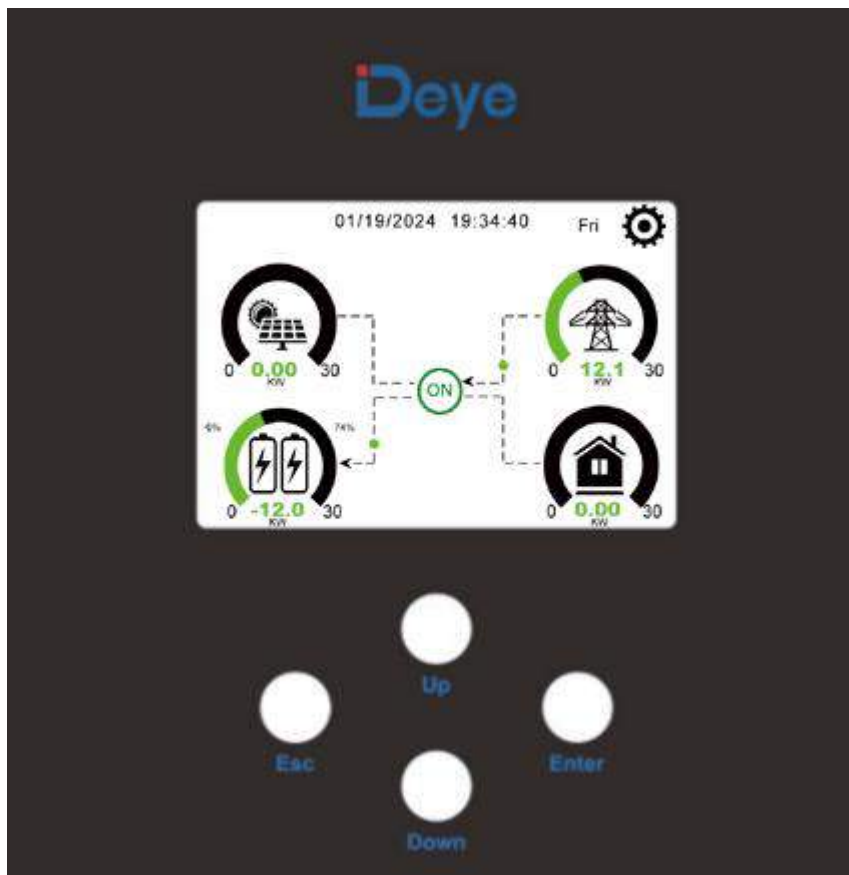

Front panel display

Function Button	Description
ESC	exit mode
Up	Go back to the previous choice
Down	skip to the next selection
Enter	confirm selection

## 7.3 Display ICONS

### Product Overview

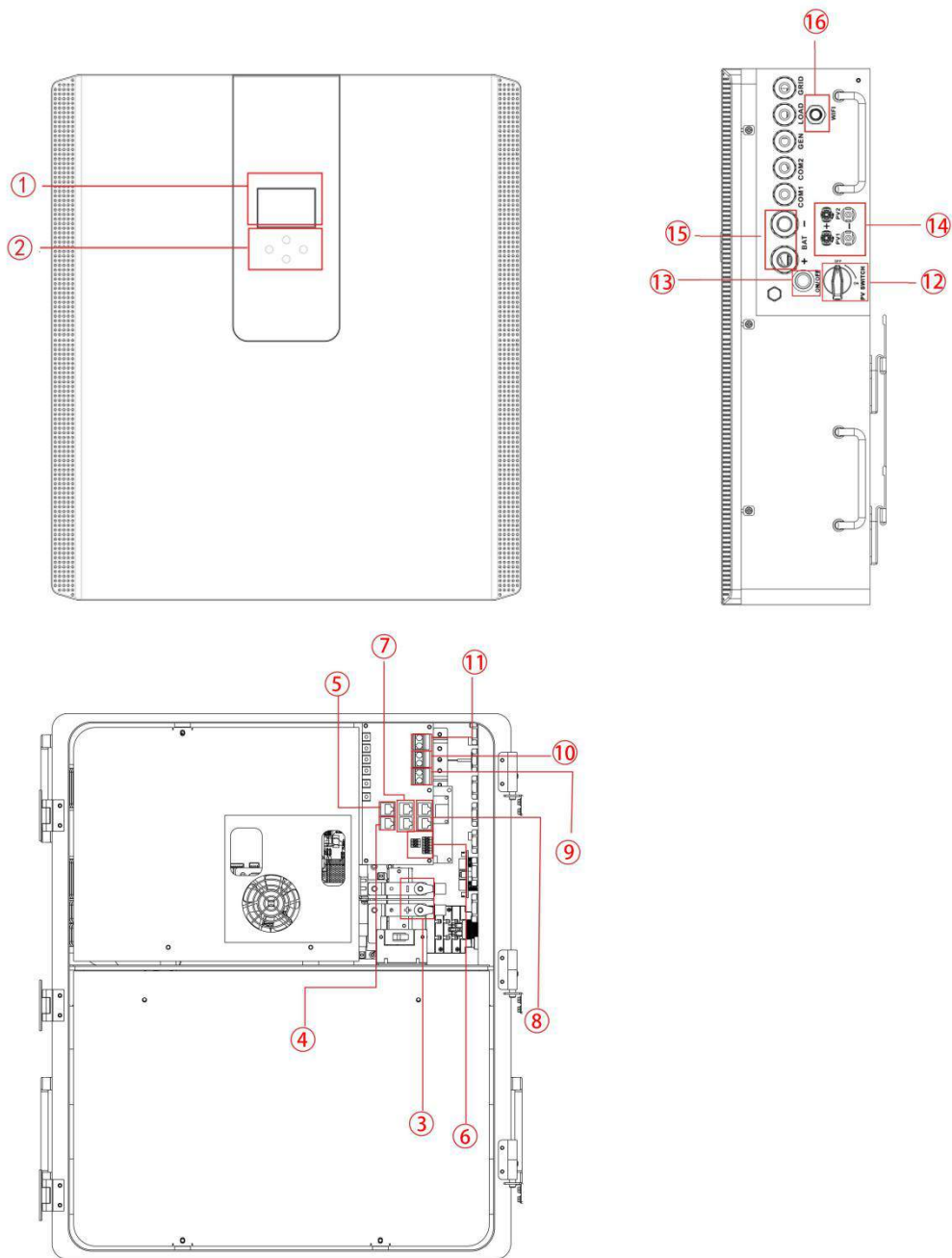

1. LCD display	7. Inverter Parallel port	12. DC Switch
2. Function Buttons	8. Battery Parallel port	13. Power on/off button
3. Battery input connectors	9. Generator input	14. PV input
4. RS485/CAN Port	10. Load	15. Battery
5. Meter Port	11. Grid	16. WiFi Interface
6. Function Port		

## 8.Mechanical Installation

### 8.1 Considering the following points before selecting where to install:

- Please select a vertical wall with load-bearing capacity for installation, suitable for installation on concrete or other non-flammable surfaces, installation is shown below.
- Install this inverter at eye level in order to allow the LCD display to be read at all times.
- The ambient temperature is recommended to be between -10~40°C to ensure optimal operation.
- Be sure to keep other objects and surfaces as shown in the diagram to guarantee sufficient heat dissipation and have enough space for removing wires.

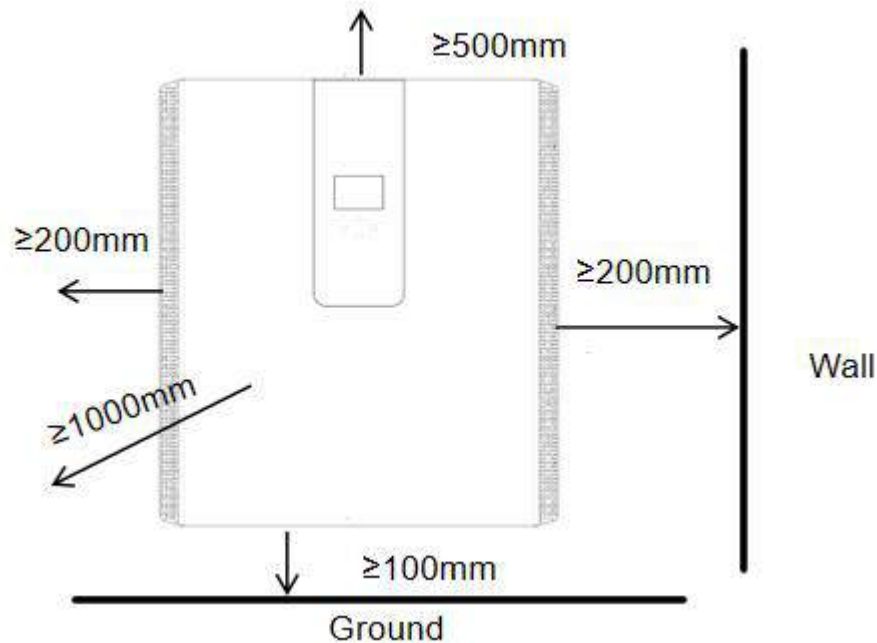

For proper air circulation to dissipate heat, the clearance is about: not less than 200mm on the side, not less than 500mm above, not less than 100mm from the ground, and 100 cm further ahead.

### 8.2 Mounting the ESS

Remember that this ESS is heavy! Please be careful when lifting out from the package. Choose the recommend drill head(as shown in below pic) to drill 4 holes on the wall,82-90mm deep.

- Use a proper hammer to fit the expansion bolt into the holes.
- Carry the ESS and holding it, make sure the hanger aim at the expansion bolt, fix the ESS on the wall.
- Fasten the screw head of the expansion bolt to finish the mounting.

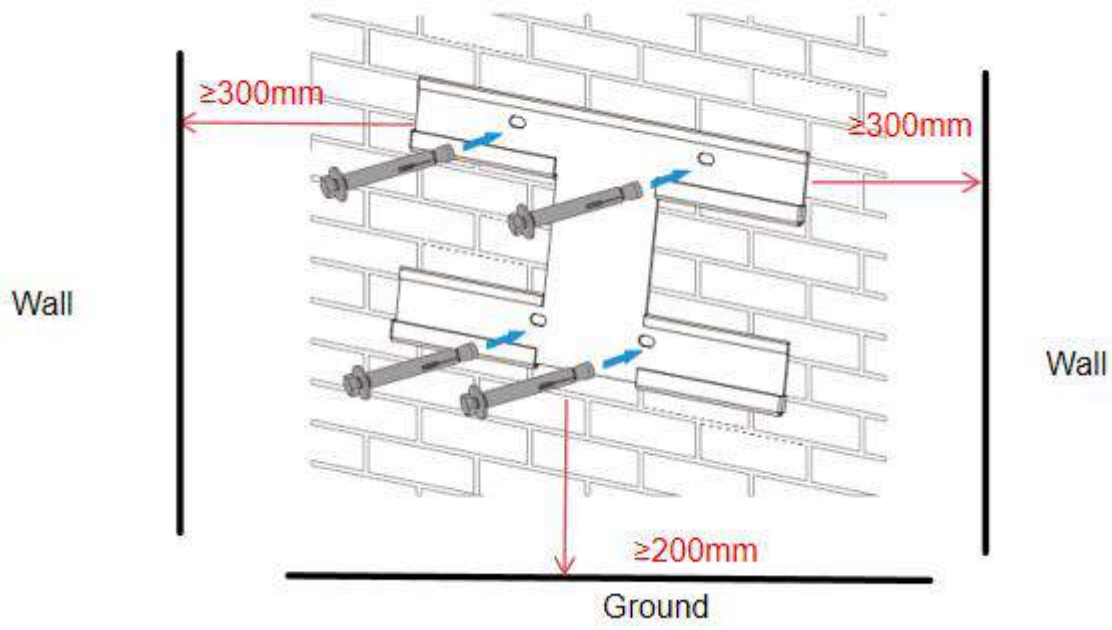

Wall mounting bracket installation

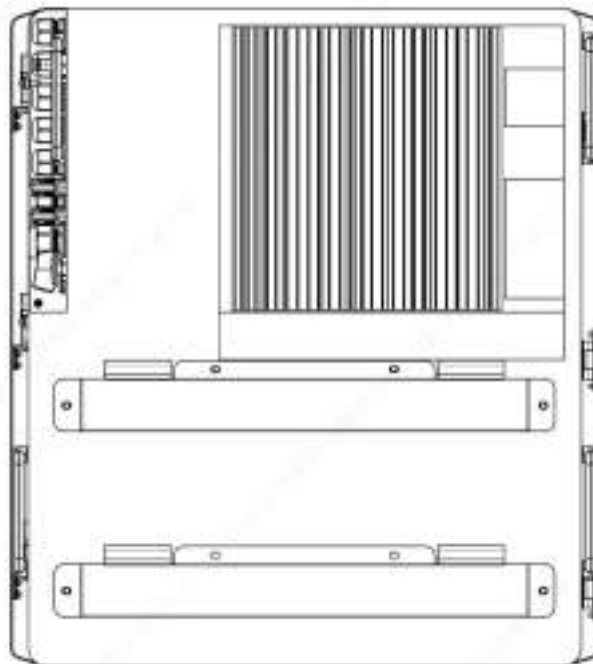

## 8.3 Function port definition

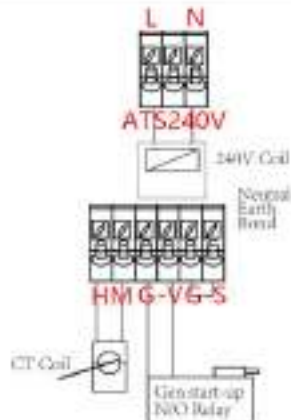
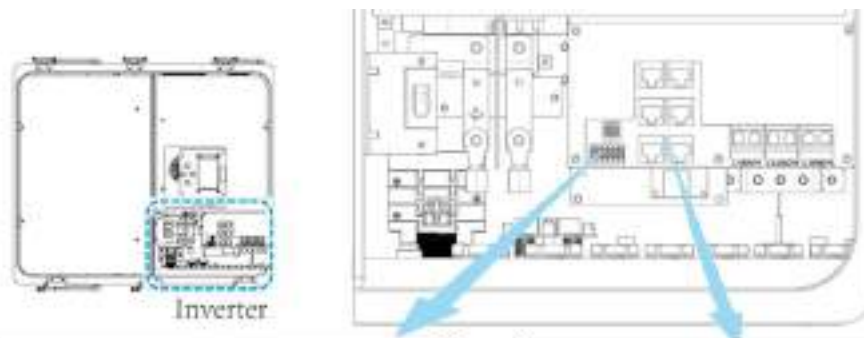

BT: Battery temperature sensor for lead acid battery.

GV/GS: Dry contact signal for startup the diesel generator.

When the "GEN signal" is active, the open contact (GV/GS) will switch on (no voltage output). If the "signal ISLAND MODE" is ticked, the Gsport will be the dry contact signal for startup the diesel generator. If "Signal ISLAND MODE" is not ticked, the GV port will be the dry contact signal for startup the diesel generator.

ATS: If the conditions are met, it will output 230 Vac.

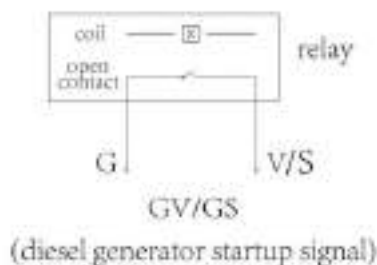

RS 485: RS485 port for energy meter communication.

BMS 485/CAN: 485/CAN port for battery communication.

DRMs: for Australia market only.

Parallel 1: Parallel communication port 1 (CAN interface).

Parallel 2: Parallel communication port 2 (CAN interface).

DI: Connect "DO" Terminal of Previous battery, for communication between multiple parallel batteries.

DO: Connect "DI" Terminal of Next battery, for communication between multiple parallel batteries.



### 8.3.1 Interface definition

Definition of RJ45 Port Pin for BMS 485/CAN.

No.	BMS 485/CAN Pin
1	485-B
2	485-A
3	GND_485
4	CAN-H
5	CAN-L
6	GND_485
7	485-A
8	485-B

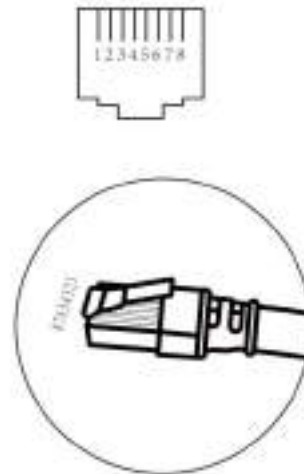

BMS485/CAN port

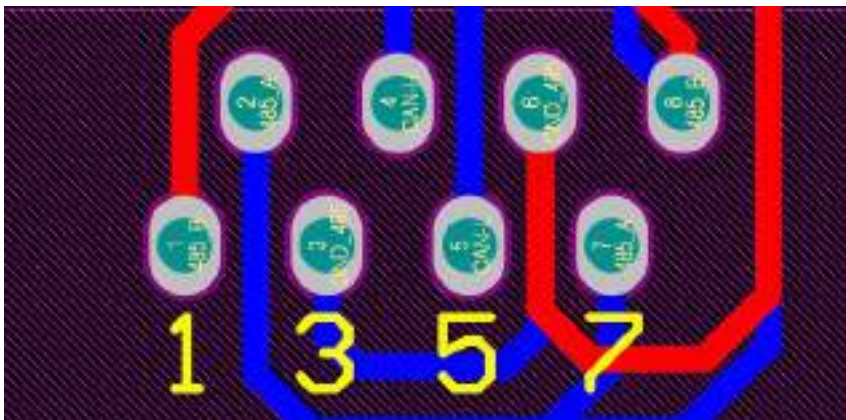

Definition of RJ45 Port Pin for RS 485.

No.	RS485 Pin
1	485-B
2	485-A
3	
4	485-B
5	485-A
6	
7	485-A
8	485-B

## RS 485 Port

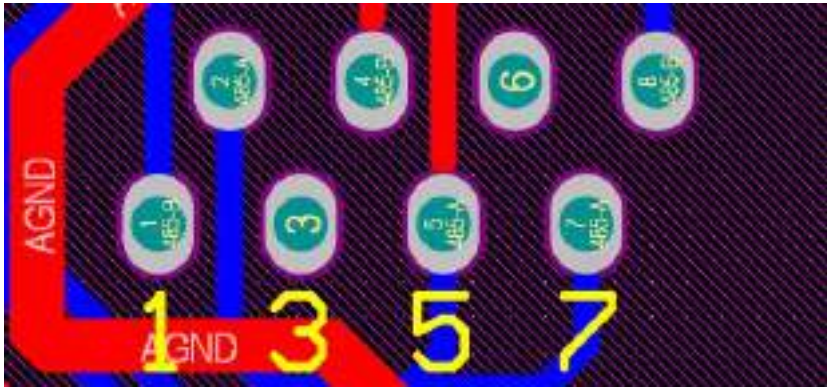

Definition of RJ45 Port Pin for parallel 1.

No.	parallel 1 Pin
1	SYNC
2	AGND
3	BINGLIAH-H
4	BINGLIAH-H
5	BINGLIAH-L
6	BINGLIAH-L
7	SYNC
8	AGND

## RS 485 Port

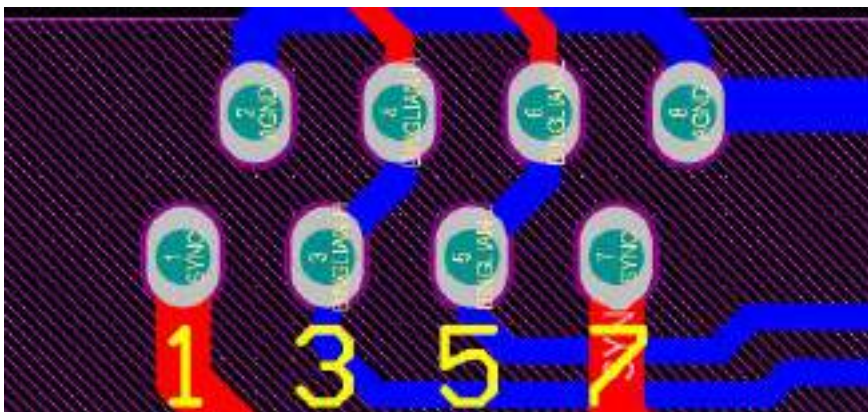

Definition of RJ45 Port Pin for parallel 2.

No.	parallel 2Pin
1	SYNC
2	AGND
3	BINGLIAH-H
4	BINGLIAH-H
5	BINGLIAH-L
6	BINGLIAH-L
7	SYNC
8	AGND

Definition of RJ45 Port Pin for parallel 2.

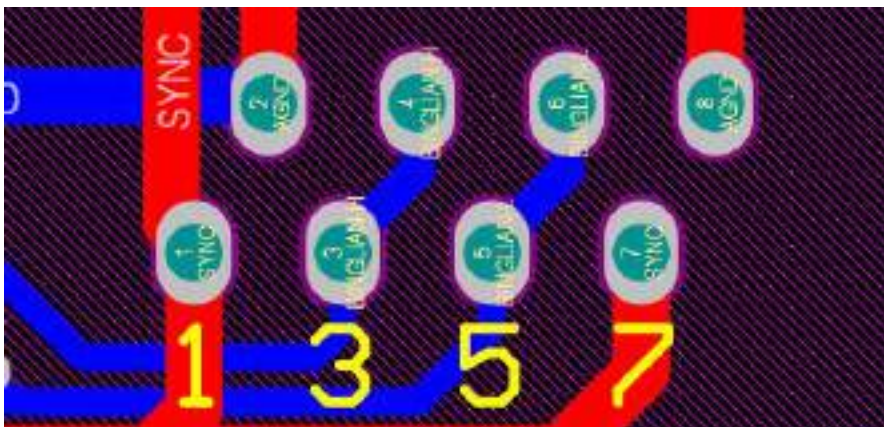

Definition of RJ45 Port Pin for DI.

No.	DI Pin
1	CAN-L
2	CAN-H
3	DI+
4	DI-
5	
6	
7	
8	

## DI Port

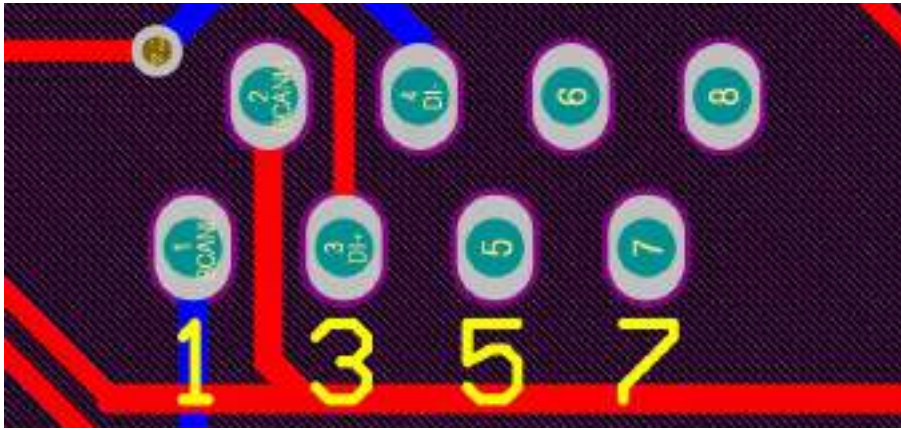

## Definition of RJ45 Port Pin for DO

No.	DOPin
1	CAN-L
2	CAN-H
3	DO+
4	DO-
5	
6	
7	
8	

## DO Port

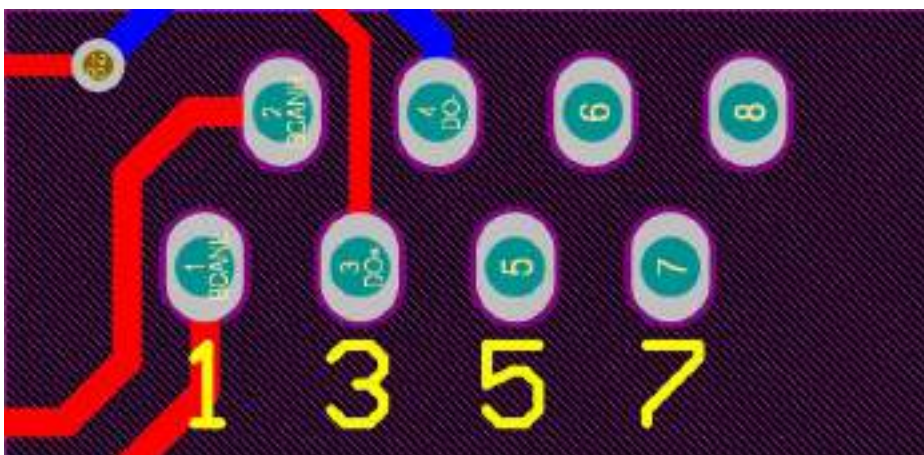

## 8.4 Grid connection and backup load connection

Before connecting to the grid, a separate AC breaker must be installed between the inverter and the grid, and also between the backup load and the inverter. This will ensure the inverter can be securely disconnected during maintenance and fully protected from over current. For the 3.6kW model, the recommended AC breaker for backup load 3.6/5kw is 40A. For the 3.6/5kW model, the recommended AC breaker for grid 3.6/5kw is 40A.

There are three terminal blocks with "Grid" "Load" and "GEN" markings. Please do not misconnect input and output connectors.



Note:

In final installation, breaker certified according to IEC 60947-1 and IEC 60947-2 shall be installed with the equipment.

All wiring must be performed by a qualified personnel. It is very important for system safety and efficient operation to use appropriate cable for AC input connection. To reduce risk of injury, please use the proper recommended cable as below.

Grid connection and backup load connection (Copper wires)

Model	Wire Size	Cable(mm <sup>2</sup> )	Torque Value (max)
3.6/5kW	8AWG	6.0	1.2Nm

Grid connection and backup load connection (Copper wires) (Bypass)

Model	Wire Size	Cable(mm <sup>2</sup> )	Torque Value (max)
3.6/5kW	8AWG	6	1.2Nm

Chart 8-4-1: Recommended Size for AC wires

### Please follow below steps to implement AC input/output connection:

1. Before making Grid, load and Gen port connection, be sure to turn off AC breaker or disconnect first.
2. Remove insulation sleeve 10mm length, unscrew the bolts. For GRID port, just insert the wires into the terminals according to polarities indicated on the terminal block. For GEN and Load ports, thread the wires through the magnetic ring firstly, then insert these wires into the terminals according to polarities indicated on the terminal block. Tighten the terminal screws and make sure the wires are completely and safely connected.

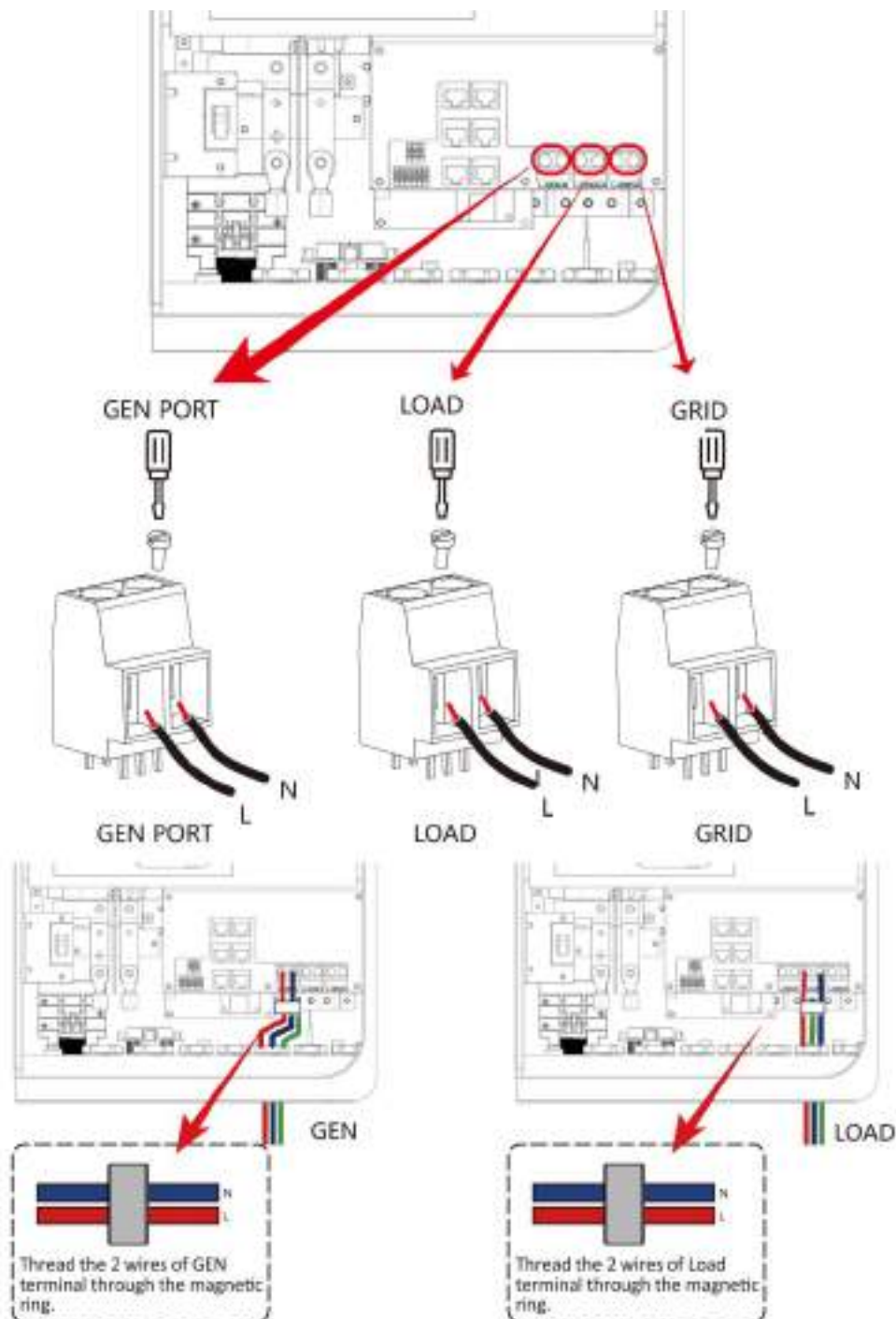

Be sure that AC power source is disconnected before attempting to wire it to the unit.

3. Then, insert AC output wires according to polarities indicated on the terminal block and tighten terminal. Be sure to connect corresponding N wires and PE wires to related terminals as well.
4. Make sure the wires are securely connected.
5. Appliances such as air conditioner are required at least 2-3 minutes to restart because it is required to have enough time to balance refrigerant gas inside of circuit. If a power shortage occurs and recovers in short time, it will cause damage to your connected appliances. To prevent this kind of damage, please check manufacturer of air conditioner if it is equipped with time-delay function before installation. Otherwise, this inverter will trigger overload fault and cut off output to protect your appliance but sometimes it still causes internal damage to the air conditioner.

## 8.5 PV Connection

Before connecting to PV modules, please install a separately DC circuit breaker between inverter and PV modules. It is very important for system safety and efficient operation to use appropriate cable for PV module connection. To reduce risk of injury, please use the proper recommended cable size as below.

Model	Wire Size	Cable(mm <sup>2</sup> )
3.6/5kW	12AWG	2.5

Chart 8-5-1: Cable size



To avoid any malfunction, do not connect any PV modules with possible current leakage to the inverter. For example, grounded PV modules will cause current leakage to the inverter. When using PV modules, please ensure the PV+ & PV- of solar panel is not connected to the system ground bar.



It is requested to use PV junction box with surge protection. Otherwise, it will cause damage on inverter when lightning occurs on PV modules.

### 8.5.1 PV Module Selection:

When selecting proper PV modules, please be sure to consider below parameters:

- 1) Open circuit Voltage (Voc) of PV modules not exceeds max. PV array open circuit voltage of inverter.
- 2) Open circuit Voltage (Voc) of PV modules should be higher than min. start voltage.
- 3) The PV modules used to connected to this inverter shall be Class A rating certified according to IEC 61730.

Inverter Model	3.6kW	5kW
PV Input Voltage	370V(125V-500V)	
PV Array MPPT Voltage Range	150V-425V	
No.of MPP Trackers	2	
No. Of Strings per MPP Tracker	1+1	

Chart 8-5-2

### 8.5.2 PV Module Wire Connection:

1. switch the Grid supply Main switch(AC)OFF.
2. Switch the Dc Isolator OFF.
3. Assemble PV input connector to the inverter.



**Safety Hint:**

When using PV modules, please ensure the PV+ & PV- of solar panel is not connected to the system ground bar.



**Safety Hint:**

Before connection, please make sure the polarity of the output voltage of PV array matches the "DC +" and "DC-" symbols.



**Safety Hint:**

Before connecting inverter, please make sure the PV array open circuit voltage is within the 500V of the inverter.

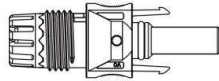

Pic 8.5.1 DC+ male connector

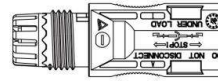

Pic 8.5.2 DC- female connector

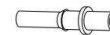
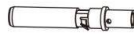

**Safety Hint:**

Please use approved DC cable for PV system.

The steps to assemble the DC connectors are listed as follows:

a) Strip off the DC wire about 7mm, disassemble the connector cap nut (see picture 7.5.3).

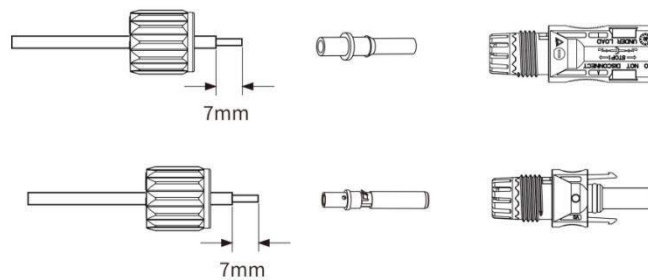

Pic 8.5.3 Disassemble the connector cap nut

b) Crimping metal terminals with crimping pliers as shown in picture 7.5.4.

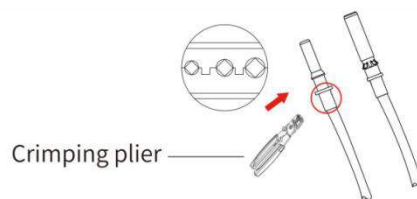

Pic 8.5.4 Crimp the contact pin to the wire



c) insert the contact pin to the top part of the connector and screw up the cap nut to the top part of the connector.(as shown in picture 7.5.5).

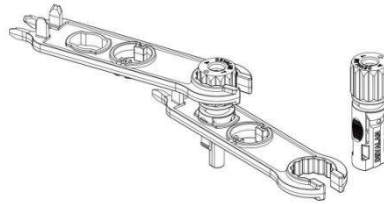

Pic 8.5.5 connector with cap nut screwed on

d) Finally insert the DC connector into the positive and negative input of the inverter, shown as picture 7.5.6.

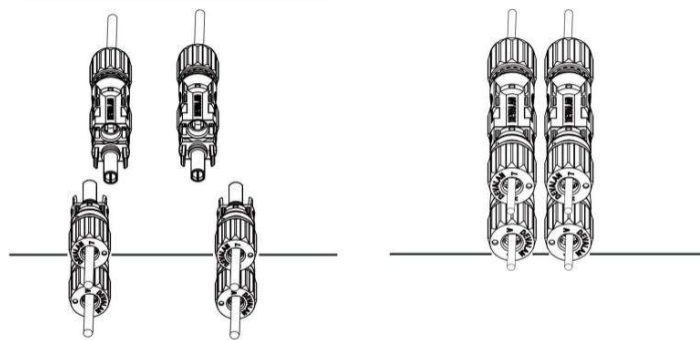

Pic 8.5.6 DC input connection



**Warning:**

Sunlight shines on the panel will generate voltage, high voltage in series may cause danger to life. Therefore, before connecting the DC input line, the solar panel needs to be blocked by the opaque material and the DC switch should be OFF',otherwise, the high voltage of the inverter may lead to life-threatening conditions.

## 8.6 CT Connection

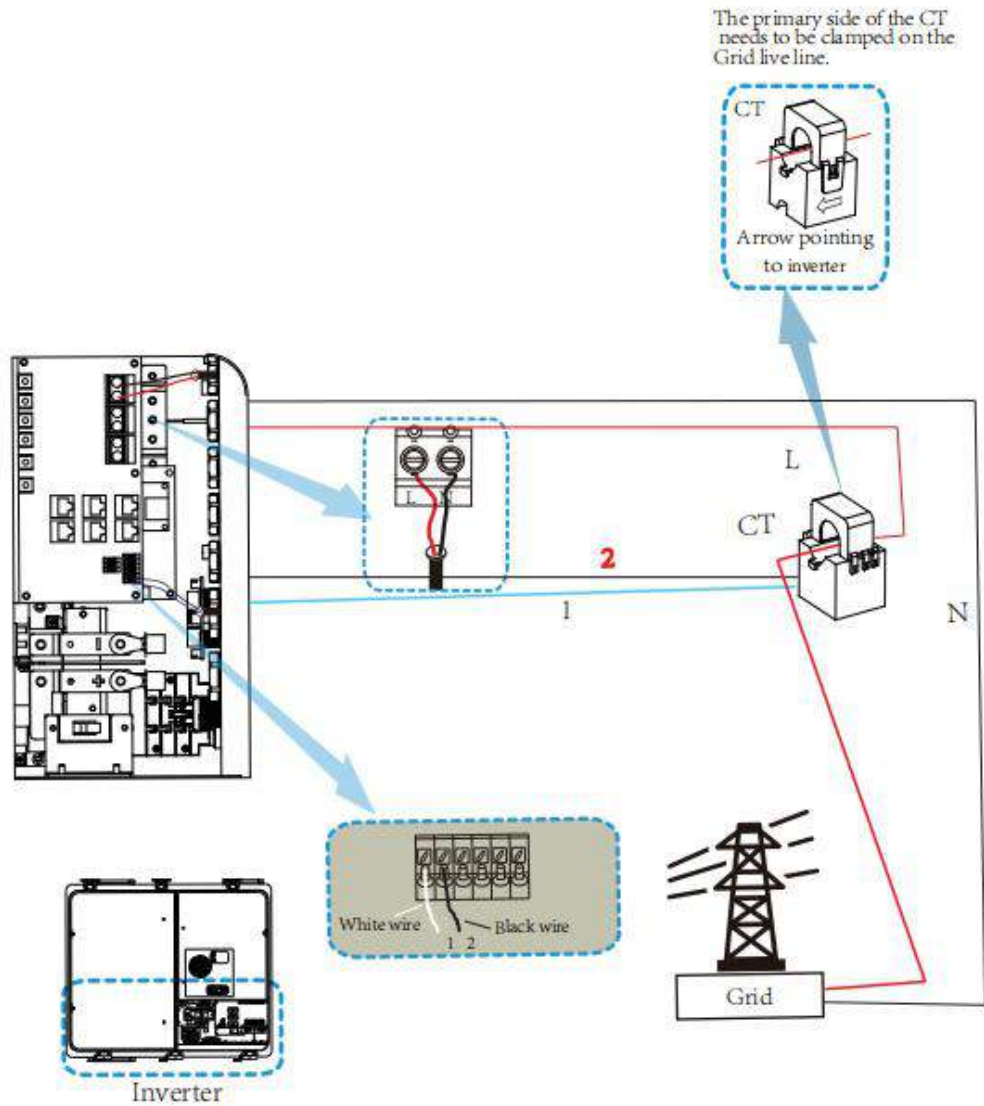

**\*Note:** when the reading of the load power on the LCD is not correct, please reverse the Ct arrow.

## 8.7 Meter Connection

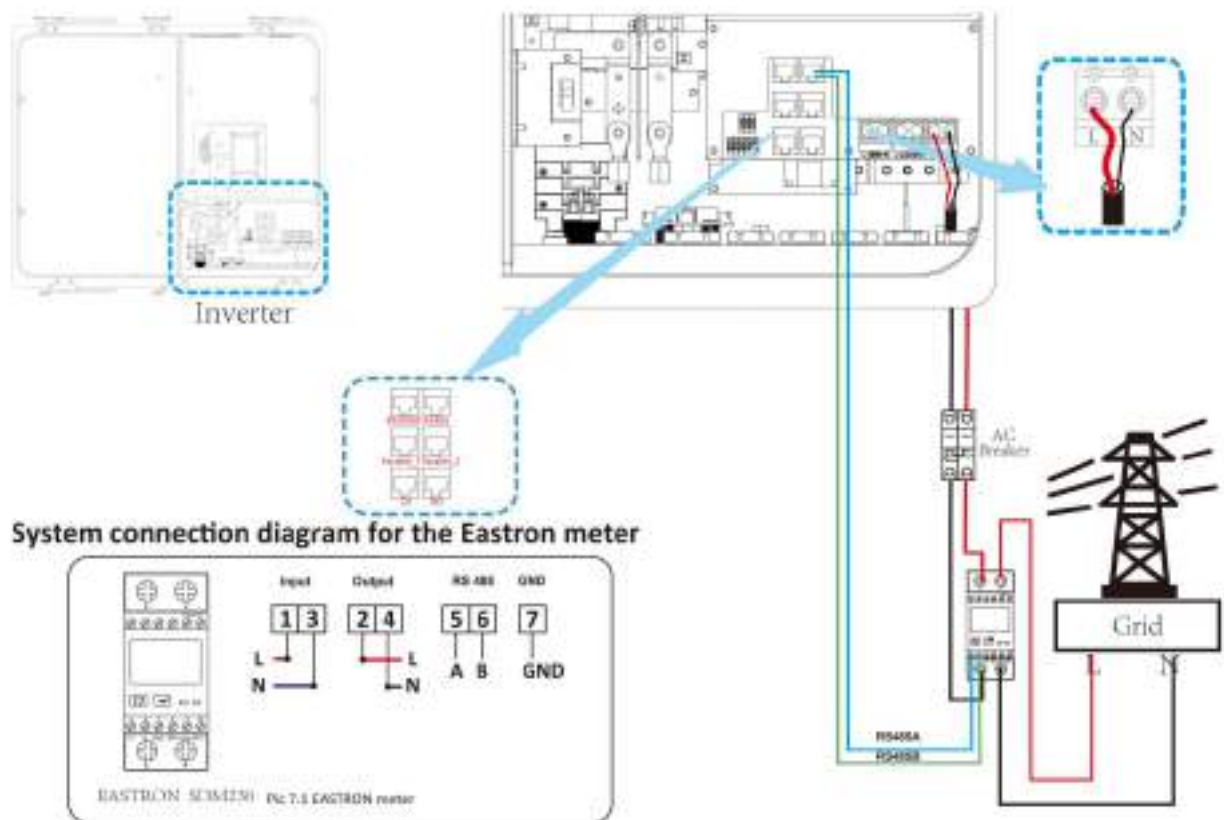
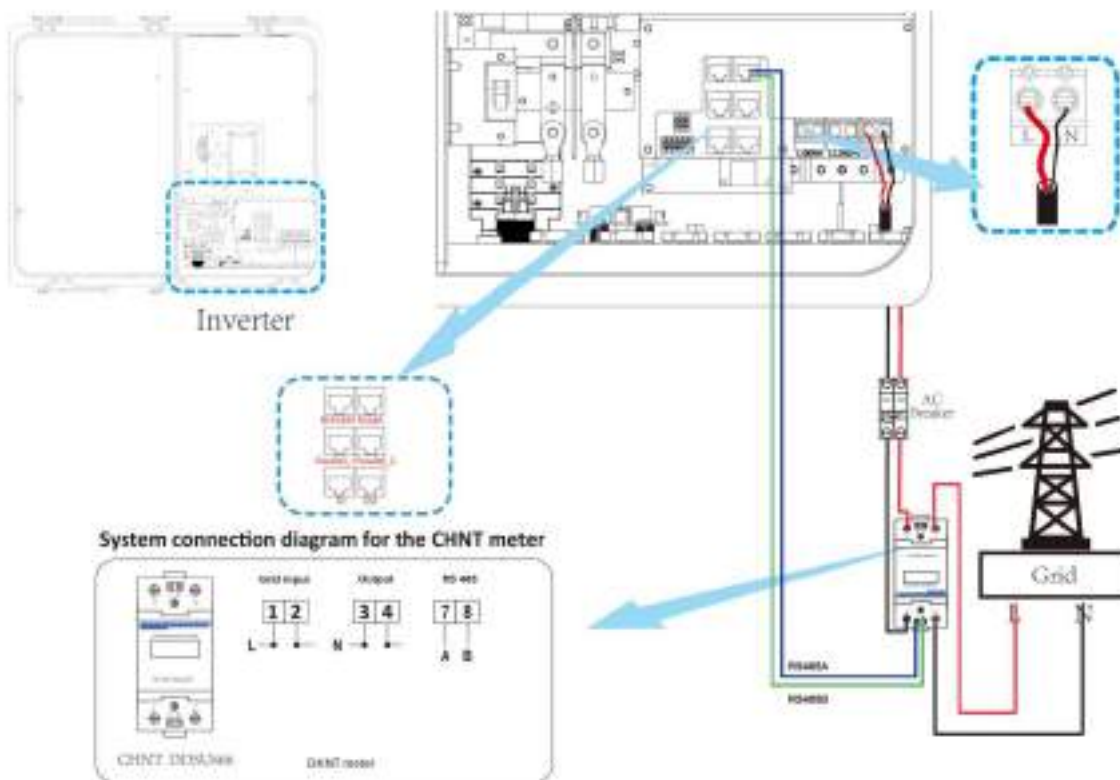

## 8.8 Earth Connection (mandatory)

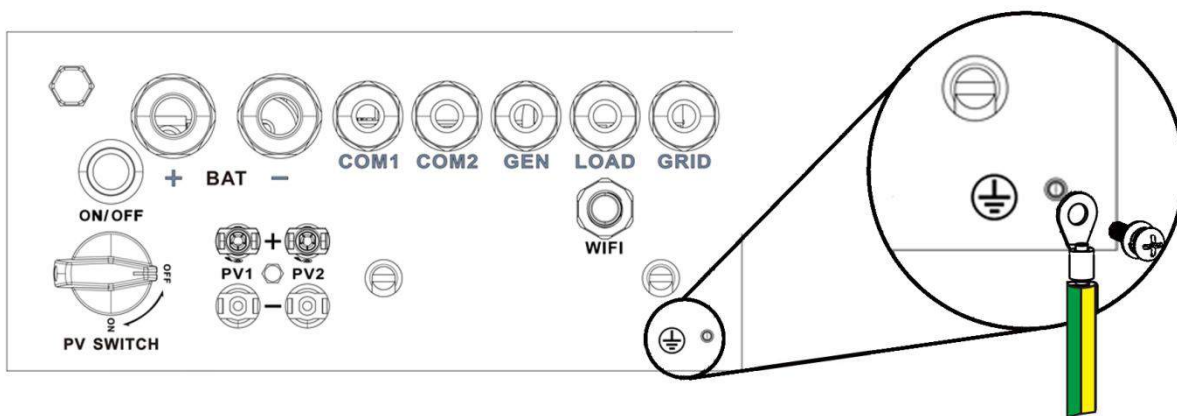

Earth connection (Copper wires)

Model	Wire Size	Cable(mm <sup>2</sup> )	Torque Value (max)
3.6/5kW	8AWG	6.0	1.2Nm

Earth connection (Copper Wires) (Bypass)

Model	Wire Size	Cable(mm <sup>2</sup> )	Torque Value (max)
3.6/5kW	8AWG	6	1.2Nm



Warning:

Inverter has built-in leakage current detection circuit, The type A RCD can be connected to the inverter for protection according to the local laws and regulations. If an external leakage current protection device is connected, its operating current must be equal to 300 mA or higher, otherwise inverter may not work properly.

## 9.Product Wiring Instructions

### 9.1 Cables for Battery Expansion

Easy to expand, support multiple parallel, support up to 16 all-in-one parallel(57.6kW/84.8kWh). At the same time, it also supports Deye 5.3kWh battery expansion,supporting a maximum of 31 battery packs in parallel with a maximum capacity of 169kWh.

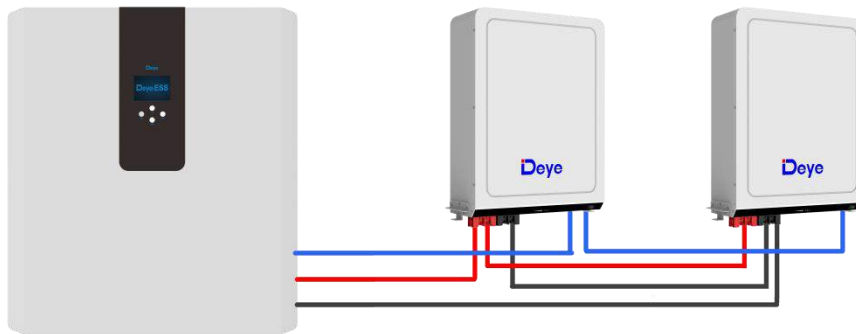

Blue is the network cable, red is the positive electrode, and black is the negative electrode.

### 9.2 Parallel Capacity Expansion

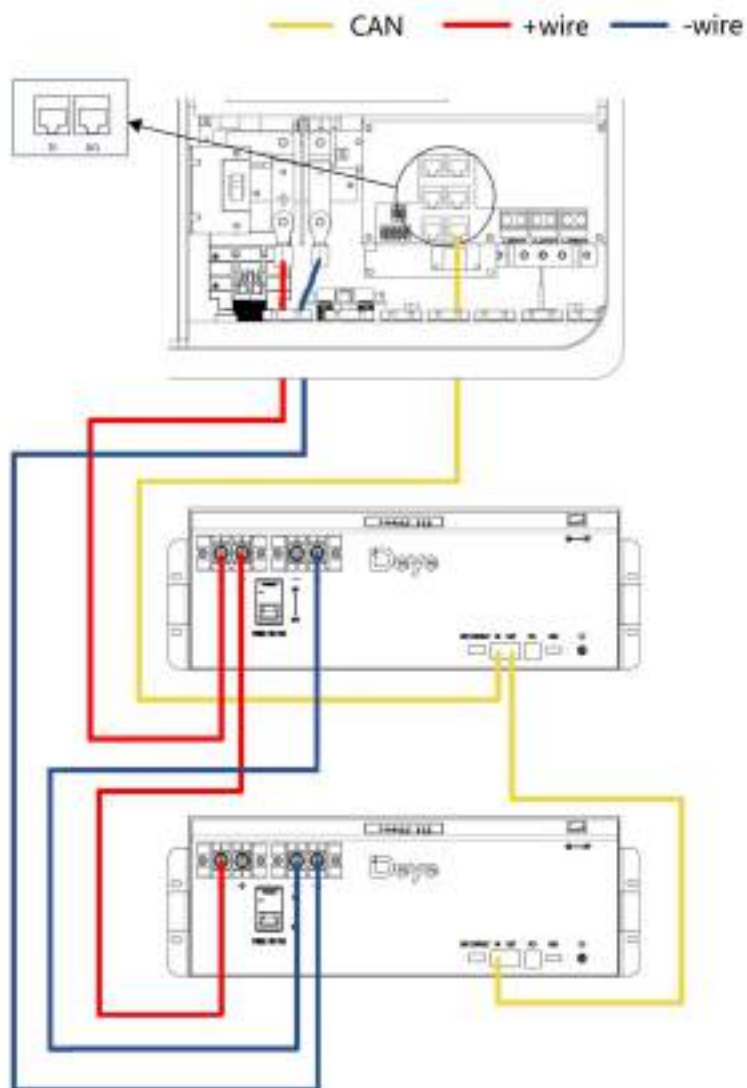

### 9.3 Typical Application Diagram of Diesel Generator

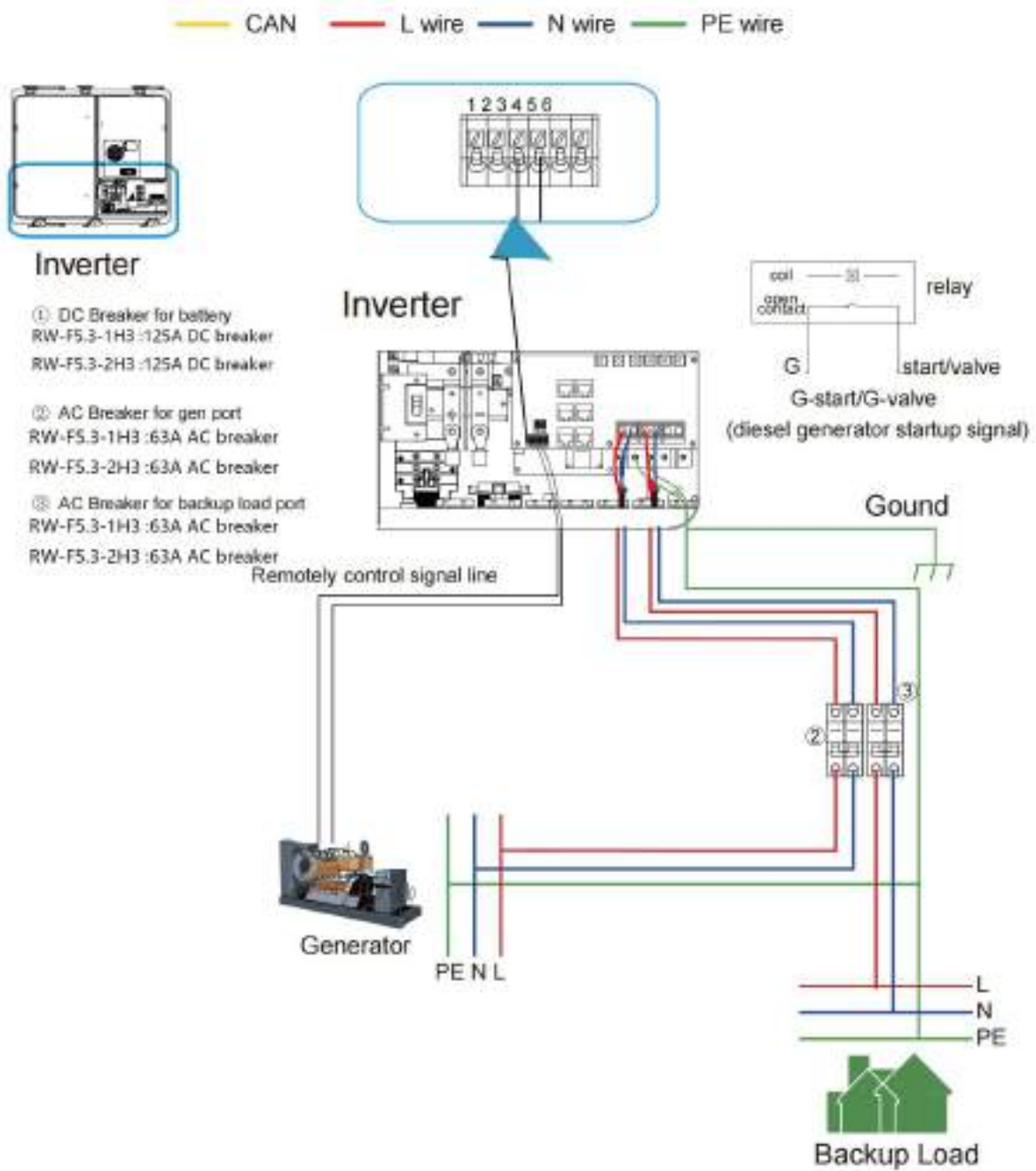

## 9.4 Single Phase Parallel Connection Diagram

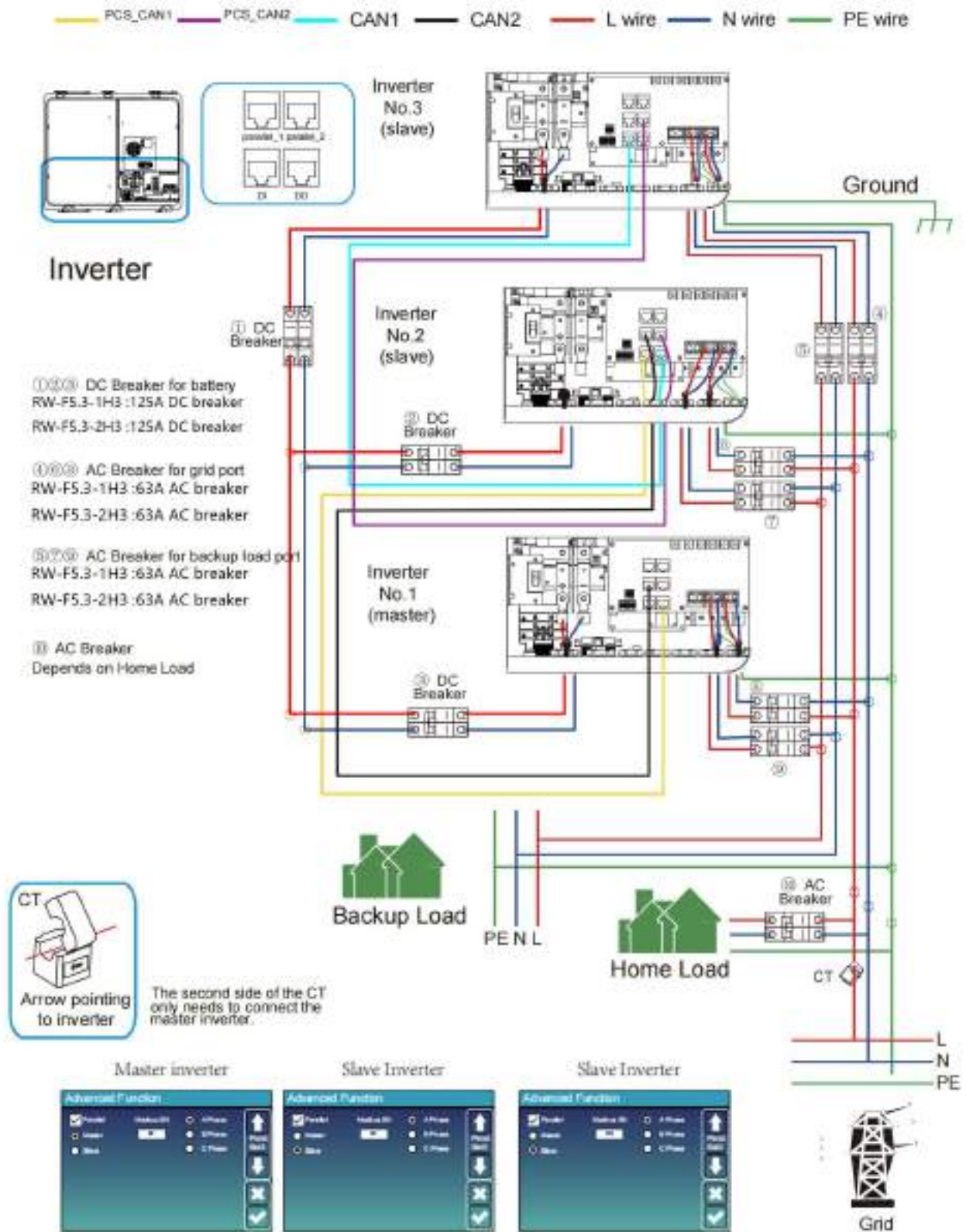

# 9.5 Three Phase Parallel Inverter

- ①②③ DC Breaker for battery  
RW-F5.3-1H3 :125A DC breaker
- RW-F5.3-2H3 :125A DC breaker
- ⑤ AC Breaker for grid port  
RW-F5.3-1H3 :63A AC breaker
- RW-F5.3-2H3 :63A AC breaker
- ④ AC Breaker for backup load  
RW-F5.3-1H3 :63A AC breaker
- RW-F5.3-2H3 :63A AC breaker
- ⑥ AC Breaker  
Depends on Home Load

PCS\_CAN1 PCS\_CAN2 CAN1 CAN2 L wire N wire PE wire

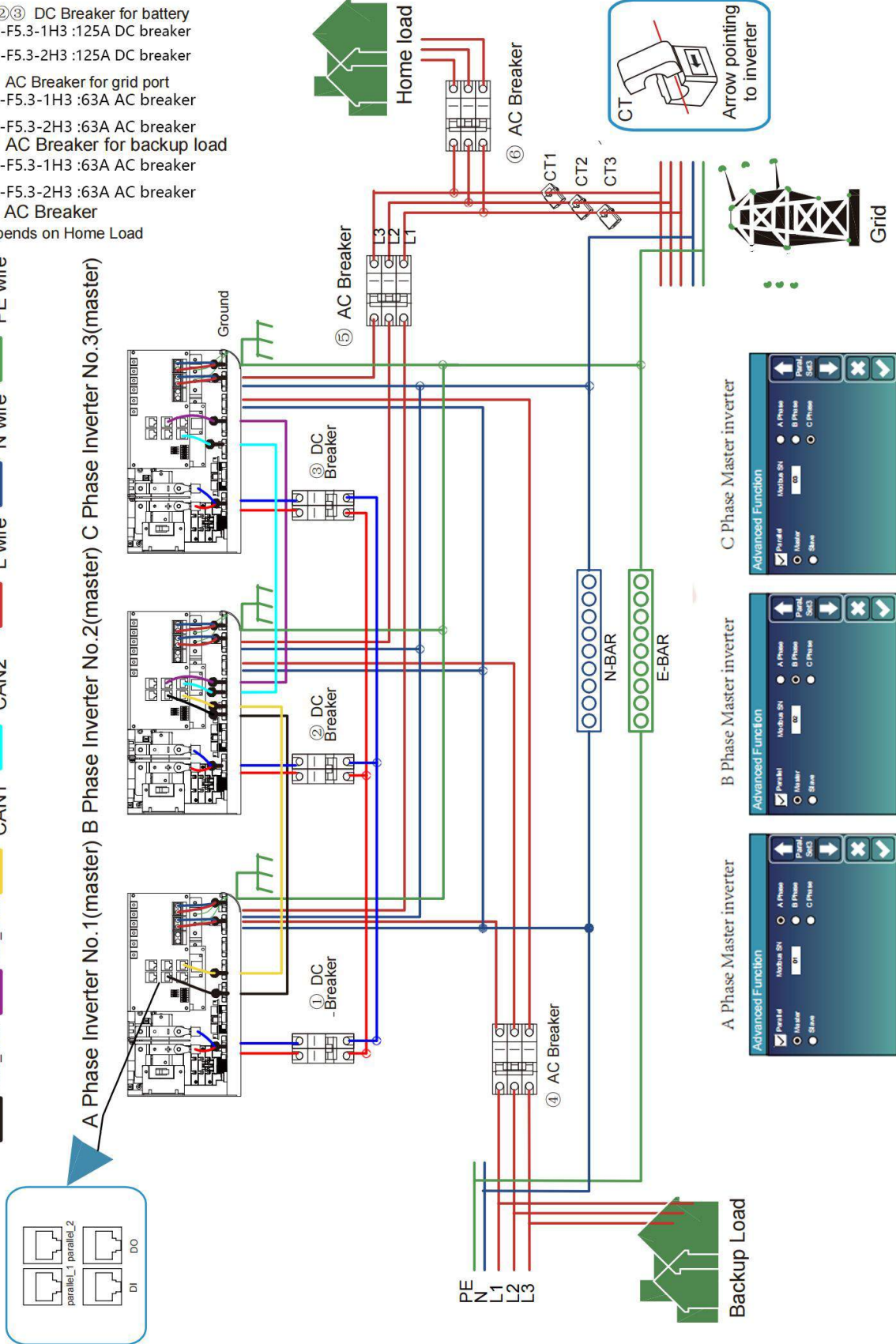



## 9.6 Wiring System for Inverter

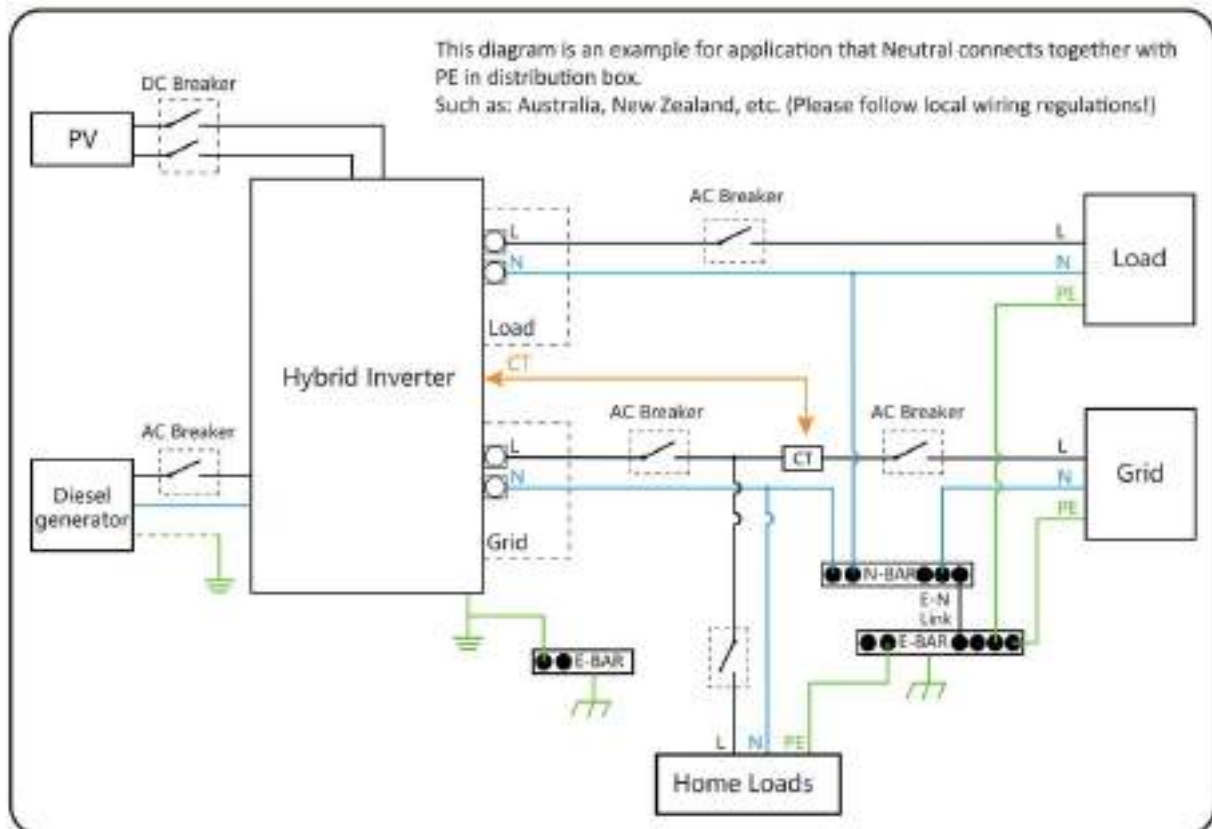
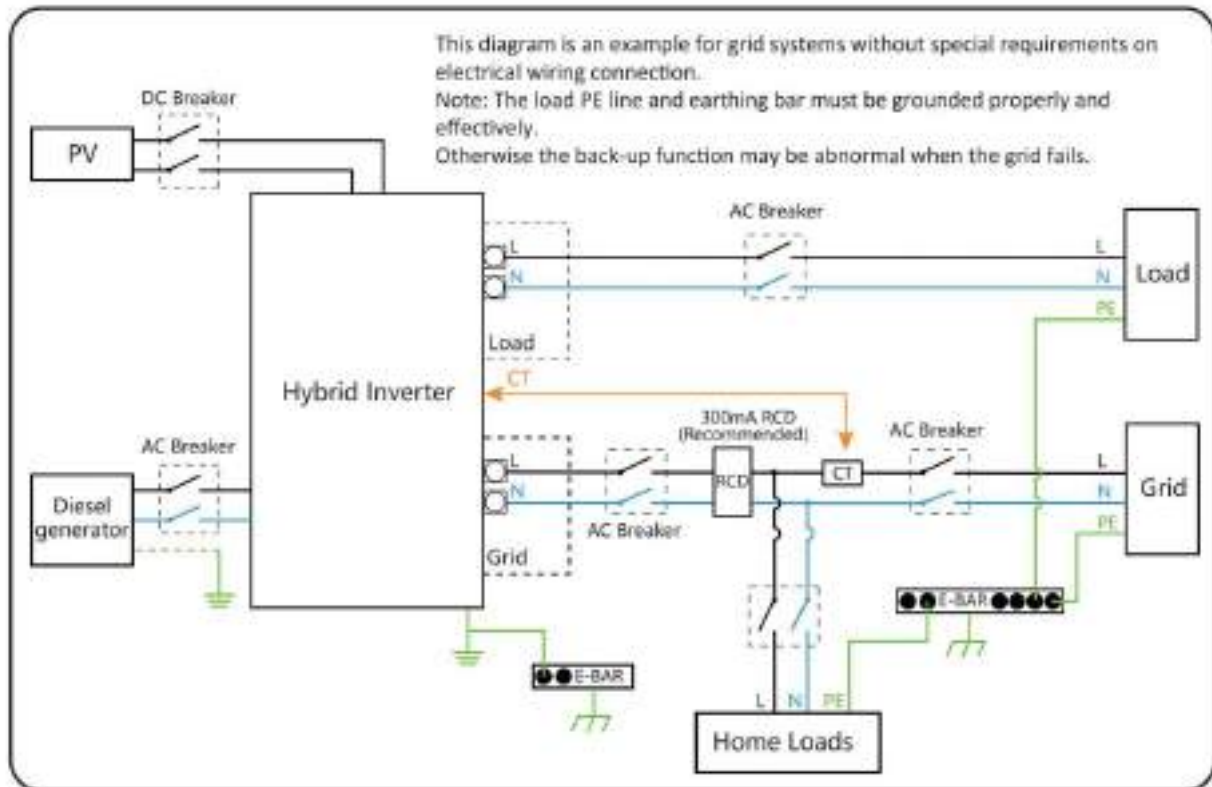

## 10.Activation product

- A. Hang the battery on the wall as shown on 8.2.
- B. Connect the wires according to the picture on 8.
- C. Unscrew the fixing buckle screw, open the buckle, and Open the cover cover,open the Air Switch first, and Close the lid, and Buckle up the buckle, and Tighten the fixing buckle screw, and then turn on the Power Button to prevent battery short-circuit protection failure caused by the pre-charge function.

### Start the Battery:

After installation, wiring, and configuration are completed, you must check all the connection. When the connections are correctly, and then press power button to activate the battery. The green working light on of the integrated machine flashes,the display screen lights up, indicating that the battery system is normal.

# 11.LCD Display Icons

## 11.1 Main Screen

The LCD is touchscreen, below screen shows the overall information of the inverter.



1.The icon in the center of the home screen indicates that the system is Normal operation. If it turns into "comm./F01~F64" , it means the inverter has communication errors or other errors, the error message will display under this icon(F01-F64 errors, detail error info can be viewed in the System Alarms menu).

2.At the top of the screen is the time.

3.System Setup Icon, Press this set button, you can enter into the system setup screen which including Basic Setup, Battery Setup, Grid Setup, System Work Mode, Generator port use, Advanced function and Li-Batt info.

4.The main screen showing the info including Solar, Grid, Load and Battery. Its also displaying the energy flow direction by arrow. When the power is approximate to high level, the color on the panels will changing from green to red so system info showing vividly on the main screen.

- PV power and Load power always keep positive.
- Grid power negative means sell to grid, positive means get from grid.
- Battery power negative means charge, positive means discharge.

### 11.1.1 LCD Operation Flow Chart

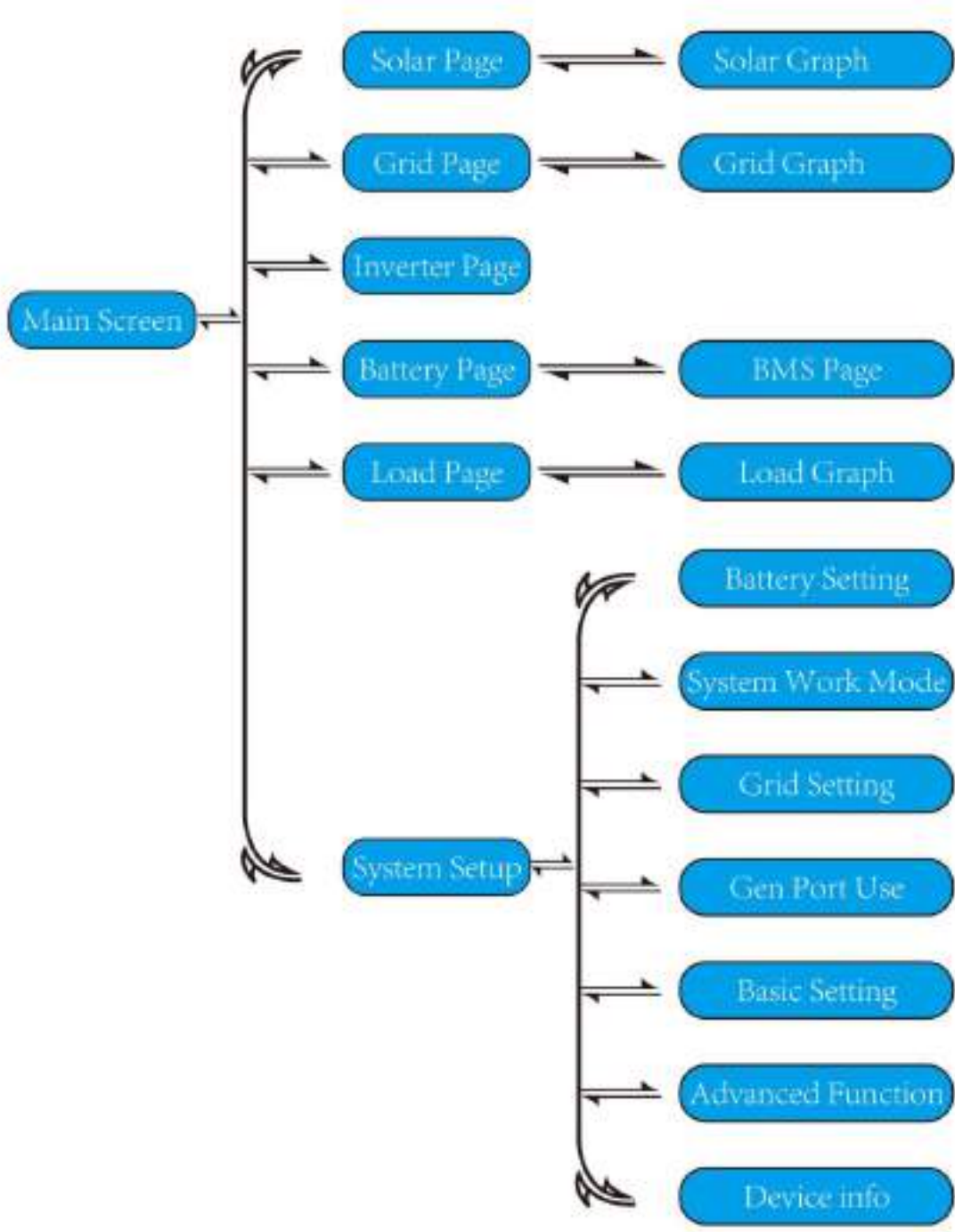

## 11.2 Solar Power Curve



### This is Solar Panel detail page.

- ① Solar Panel Generation.
  - ② **Grid Tie Power:** when there's a string inverter AC couple at the grid or load side of hybrid inverter and there's a meter installed for the string inverter, then the hybrid inverter LCD will show the string inverter output power on its PV icon. Please make sure the meter can communicate with the hybrid inverter successfully.
  - ③ Voltage, Current, Power for each MPPT.
  - ④ Solar Panel energy for Day and Total.
- Press the "Energy" button will enter into the power curve page.

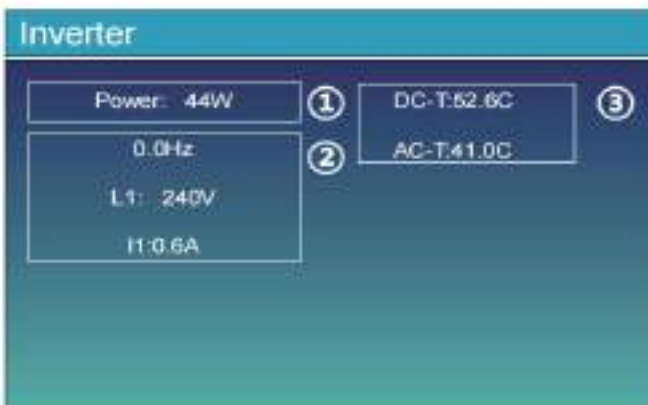

### This is Inverter detail page.

- ① Inverter Generation.
  - ② 0.0Hz: frequency after DC/AC. Voltage, Current, Power for each Phase.
  - ③ \*DC-T: mean DC-DC temperature, AC-T: mean Heat-sink temperature.
- \*Note: this part info is not available for some LCD FW.



### This is Load detail page.

- ① Load Power.
  - ② Voltage, Power for each Phase.
  - ③ Daily and total Load consumption .
- When you check "Selling First" or "Zero export to Load" on system work mode page, the information on this page is about backup load which connect on Load port of hybrid inverter.
- When you check "Zero export to CT" on system work mode page, the information on this page is including backup load and home load.
- Press the "Energy" button will enter into the power curve page.



### This is Grid detail page.

- ① Status, Power, Frequency.
  - ② L: Voltage for each Phase  
CT: Power detected by the external current sensors  
LD: Power detected using internal sensors on AC grid in/out breaker
  - ③ BUY: Energy from Grid to Inverter,  
SELL: Energy from Inverter to grid.
- Press the "Energy" button will enter into the power curve page.

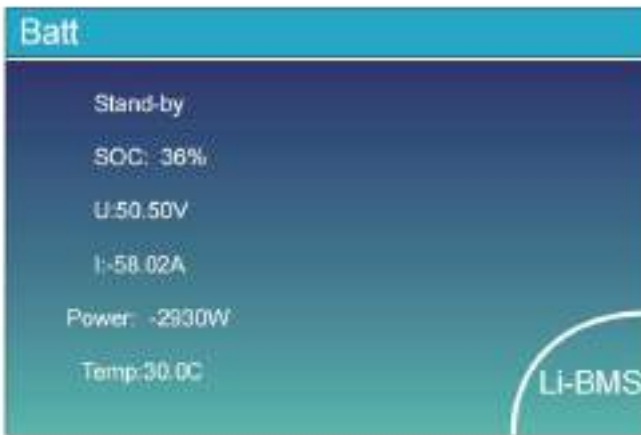

This is Battery detail page.

if you use Lithium Battery, you can enter BMS page.



**Request Force Charge:** It indicates the BMS requests hybrid inverter to charge the battery actively.

	Volt	Curr	Temp	SOC	Energy	Charge Volt	Curr	Fault
1	50.34V	55.00A	30.0C	38.0%	25.0Ah	53.2V	50.0A	300
2	50.33V	55.11A	31.9C	31.0%	24.92Ah	53.2V	50.0A	300
3	50.35V	55.00A	30.0C	32.0%	24.88Ah	53.2V	50.0A	300
4	50.0V	55.0A	30.0C	30.0%	24.8A	53.0V	50.0A	300
5	50.0V	55.0A	30.0C	30.0%	24.8A	53.0V	50.0A	300
6	50.0V	55.0A	30.0C	30.0%	24.8A	53.0V	50.0A	300
7	50.0V	55.0A	30.0C	30.0%	24.8A	53.0V	50.0A	300
8	50.0V	55.0A	30.0C	30.0%	24.8A	53.0V	50.0A	300
9	50.0V	55.0A	30.0C	30.0%	24.8A	53.0V	50.0A	300
10	50.0V	55.0A	30.0C	30.0%	24.8A	53.0V	50.0A	300
11	50.0V	55.0A	30.0C	30.0%	24.8A	53.0V	50.0A	300
12	50.0V	55.0A	30.0C	30.0%	24.8A	53.0V	50.0A	300
13	50.0V	55.0A	30.0C	30.0%	24.8A	53.0V	50.0A	300
14	50.0V	55.0A	30.0C	30.0%	24.8A	53.0V	50.0A	300
15	50.0V	55.0A	30.0C	30.0%	24.8A	53.0V	50.0A	300

## 11.2 Curve Page-Solar & Load & Grid



Solar power curve for daily, monthly, yearly and total can be roughly checked on the LCD, for more accuracy power generation, pls check on the monitoring system. Click the up and down arrow to check power curve of different period.

### 11.3 System Setup Menu

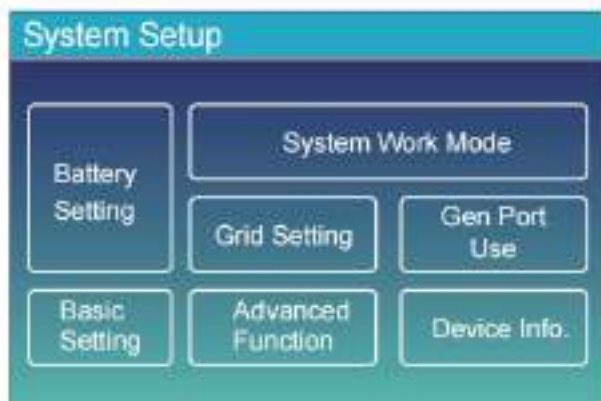

This is System Setup page.

### 11.4 Basic Setup Menu



**Factory Reset:** Reset all parameters of the inverter.  
**Lock out all changes:** Enable this menu for setting parameters that require locking and cannot be set up. Before performing a successful factory reset and locking the systems, to keep all changes you need to type in a password to enable the setting. The password for factory settings is 9999 and for lock out is 7777.



**Factory Reset Password:** 9999  
**Lock out all changes Password:** 7777  
 System selfchek: After ticking this item, it needs input the password. The default password is 1234

# 11.5 Battery Setup Menu



**Battery capacity:** it tells Deye hybrid inverter to know your battery bank size.  
**Use Batt V:** Use Battery Voltage for all the settings (V).  
**Use Batt %:** Use Battery SOC for all the settings (%).  
**Max. A charge/discharge:** Max battery charge/discharge current(0-140A for 3KW-24 model,0-70A for 3KW model, 0-90A for 3.6KW model,0-120A for 5KW model, 0-135A for 6KW model).  
 For AGM and Flooded, we recommend Ah battery size x 20%= Charge/Discharge amps.  
 . For Lithium, we recommend Ah battery size x 50% = Charge/Discharge amps.  
 . For Gel, follow manufacturer' s instructions.  
**No Batt:** tick this item if no battery is connected to the system.

**Active battery:** This feature will help recover a battery that is over discharged by slowly charging from the solar array or grid.  
**Disable Float Charge:** For the lithium battery with BMS communication, the inverter will keep the charging voltage at the current voltage when the BMS charging current requested is 0. It is used to help prevent battery from being overcharged.



**This is Battery Setup page. ① ③**  
**Start =30%:** Percent S.O.C at 30% system will AutoStart a connected generator to charge the battery bank.  
**A = 40A:** Charge rate of 40A from the attached generator in Amps.  
**Gen Charge:** uses the gen input of the system to charge battery bank from an attached generator.  
**Gen Signal:** Normally open relay that closes when the Gen Start signal state is active.  
**Gen Force:** When the generator is connected, it is forced to start the generator without meeting other conditions.

**This is Grid Charge, you need select. ②**  
**Start =30%:** No use, Just for customization.  
**A = 40A:** It indicates the Current that the Grid charges the Battery.  
**Grid Charge:** It indicates that the grid charges the battery.  
**Grid Signal:** Disable.

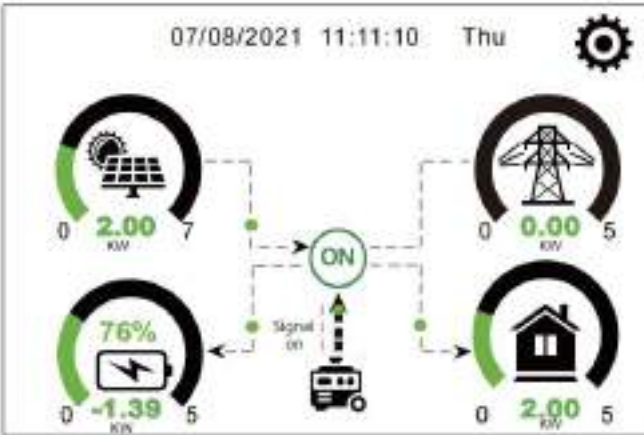

This page tells the PV and diesel generator power the load and battery.



**Generator**

Power: 1392W      Today=0.0 KWH  
 Total =2.20 KWH

L1: 228V

Freq:50.0Hz

This page tells generator output voltage, frequency, power. And, how much energy is used from generator.

**Battery Setting**

Lithium Mode

Shutdown

Low Batt

Restart

Batt Set3

**Lithium Mode:** This is BMS protocol. Please reference the document (Approved Battery).

**Shutdown 10%:** It indicates the inverter will shutdown if the SOC below this value.

**Low Batt 20%:** It indicates the inverter will alarm if the SOC below this value.

**Restart 40%:** Battery voltage at 40% AC output will resume.

**Battery Setting**

Float V **①**

Absorption V

Equalization V

Equalization Days

Equalization Hours

Shutdown **③**

Low Batt

Restart

TEMPCO (mV/C/Cell) **②**

Batt Resistance

Batt Set3

**There are 3 stages of charging the Battery .** **①**

This is for professional installers, you can keep it if you do not know. **②**

**Shutdown 20%:** The inverter will shutdown if the SOC below this value.

**Low Batt 35%:** The inverter will alarm if the SOC below this value. **③**

**Restart 50%:** Battery SOC at 50% AC output will resume.

**Recommended battery settings**

Battery Type	Absorption Stage	Float Stage	Equalization Voltage (every 30 days 3hr )
AGM (or PCC)	14.2V (57.6V)	13.4V (53.6V)	14.2V (57.6V)
Gel	14.1V (56.4V)	13.5V (54.0V)	
Wet	14.7V (59.0V)	13.7V (55.0V)	14.7V (59.0V)
Lithium	Follow its BMS voltage parameters		

# 11.6 System Work Mode Setup Menu

### System Work Mode

Selling First    5000 Max Solar Power

Zero Export To Load     Solar Sell

Zero Export To CT     Solar Sell

Max Sell Power: 5000    Zero-export Power: 20

Energy pattern:  BattFirst     LoadFirst

Grid Peak Shaving    5000 Power

↑  
Work Mode 1  
↓

✕

✓

**Work Mode**  
**Selling First:** This Mode allows hybrid inverter to sell back any excess power produced by the solar panels to the grid. If time of use is active, the battery energy also can be sold into grid. The PV energy will be used to power the load and charge the battery and then excess energy will flow to grid. Power source priority for the load is as follows:  
 1. Solar Panels.  
 2. Grid.  
 3. Batteries (until programable % discharge is reached).

**Zero Export To Load:** Hybrid inverter will only provide power to the backup load connected. The hybrid inverter will neither provide power to the home load nor sell power to grid. The built-in CT will detect power flowing back to the grid and will reduce the power of the inverter only to supply the local load and charge the battery.

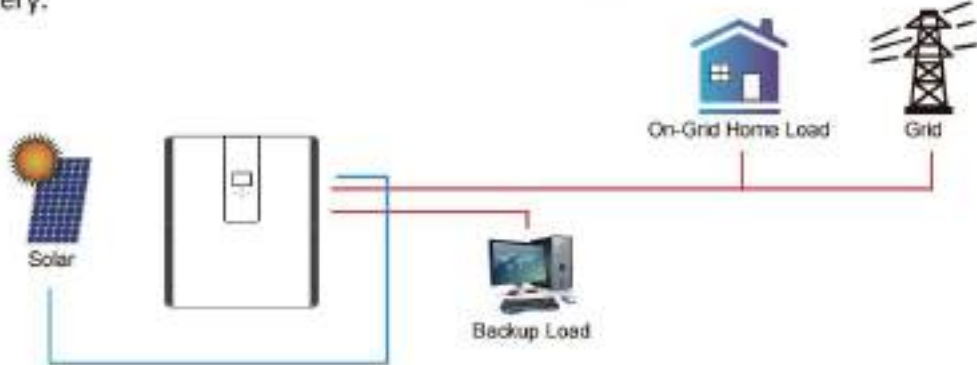

**Zero Export To CT:** Hybrid inverter will not only provide power to the backup load connected but also give power to the home load connected. If PV power and battery power is insufficient, it will take grid energy as supplement. The hybrid inverter will not sell power to grid. In this mode, a CT is needed. The installation method of the CT please refer to chapter 3.6 CT Connection. The external CT will detect power flowing back to the grid and will reduce the power of the inverter only to supply the local load, charge battery and home load.

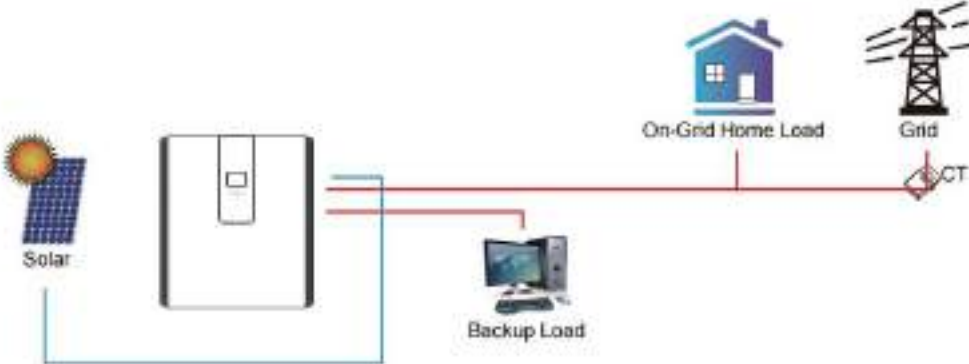

**Solar Sell:** "Solar sell" is for Zero export to load or Zero export to CT: when this item is active, the surplus energy can be sold back to grid. When it is active, PV Power source priority usage is as follows: load consumption and charge battery and feed into grid.

**Max. sell power:** Allowed the maximum output power to flow to grid.

**Zero-export Power:** for zero-export mode, it tells the grid output power. Recommend to set it as 20-100W to ensure the hybrid inverter won't feed power to grid.

**Energy Pattern:** PV Power source priority.

**Batt First:** PV power is firstly used to charge the battery and then used to power the load. If PV power is insufficient, grid will make supplement for battery and load simultaneously.

**Load First:** PV power is firstly used to power the load and then used to charge the battery. If PV power is insufficient, grid will make supplement for battery and load simultaneously.

**Max Solar Power:** allowed the maximum DC input power.

**Grid Peak-shaving:** when it is active, grid output power will be limited within the set value. If the load power exceeds the allowed value, it will take PV energy and battery as supplement. If still can't meet the load requirement, grid power will increase to meet the load needs.

**System Work Mode**

Grid Charge	Gen	Time	Power	Batt	
<input type="checkbox"/>	<input type="checkbox"/>	01:00	5:00	5000	49.0V
<input type="checkbox"/>	<input type="checkbox"/>	05:00	9:00	5000	50.2V
<input checked="" type="checkbox"/>	<input type="checkbox"/>	09:00	13:00	5000	50.9V
<input checked="" type="checkbox"/>	<input type="checkbox"/>	13:00	17:00	5000	51.4V
<input checked="" type="checkbox"/>	<input type="checkbox"/>	17:00	21:00	5000	47.1V
<input checked="" type="checkbox"/>	<input type="checkbox"/>	21:00	01:00	5000	49.0V

Time Of Use:

Work Mode2

**Time of use:** it is used to program when to use grid or generator to charge the battery, and when to discharge the battery to power the load. Only tick "Time Of Use" then the follow items (Grid, charge, time, power etc.) will take effect.

**Note:** when in selling first mode and click time of use, the battery power can be sold into grid.

**Grid charge:** utilize grid to charge the battery in a time period.

**Gen charge:** utilize diesel generator to charge the battery in a time period.

**Time:** real time, range of 01:00-24:00.

**Power:** Max. discharge power of battery allowed.

**Batt(V or SOC %):** battery SOC % or voltage at when the action is to happen.

**For example:**

During 01:00-05:00, when battery SOC is lower than 80%, it will use grid to charge the battery until battery SOC reaches 80%.

During 05:00-08:00 and 08:00-10:00, when battery SOC is higher than 40%, hybrid inverter will discharge the battery until the SOC reaches 40%.

During 10:00-15:00, when battery SOC is higher than 80%, hybrid inverter will discharge the battery until the SOC reaches 80%.

During 15:00-18:00, when battery SOC is higher than 40%, hybrid inverter will discharge the battery until the SOC reaches 40%.

During 18:00-01:00, when battery SOC is higher than 35%, hybrid inverter will discharge the battery until the SOC reaches 35%.

**System Work Mode**

Grid Charge	Gen	Time	Power	Batt	
<input checked="" type="checkbox"/>	<input type="checkbox"/>	01:00	5:00	5000	80%
<input type="checkbox"/>	<input type="checkbox"/>	05:00	8:00	5000	40%
<input type="checkbox"/>	<input type="checkbox"/>	08:00	10:00	5000	40%
<input type="checkbox"/>	<input type="checkbox"/>	10:00	15:00	5000	80%
<input type="checkbox"/>	<input type="checkbox"/>	15:00	18:00	5000	40%
<input type="checkbox"/>	<input type="checkbox"/>	18:00	01:00	5000	35%

Time Of Use:

Work Mode2

**System Work Mode**

Mon	Tue	Wed	Thu	Fri	Sat	Sun
<input checked="" type="checkbox"/>	<input checked="" type="checkbox"/>	<input checked="" type="checkbox"/>	<input checked="" type="checkbox"/>	<input checked="" type="checkbox"/>	<input checked="" type="checkbox"/>	<input type="checkbox"/>

Work Mode4

It allows users to choose which day to execute the setting of "Time of Use".

For example, the inverter will execute the time of use page on Mon/Tue/Wed/Thu/Fri/Sat only.

# 11.7 Grid Setup Menu

**Unlock Grid Setting:** before changing the grid parameters, please enable this with password of 7777. Then it is allowed to change the grid parameters.

**Grid Mode:** General Standard, UL1741 & IEEE1547, CPUC RULE21, SRD-UL-1741, CEI 0-21, EN50549\_CZ, Australia\_A, Australia\_B, Australia\_C, NewZealand, VDE4105, OVE\_Directive\_R25, EN50549\_CZ\_PPDS\_L16A, NRS097, G98/G99, G98/G99\_NI, ESB Networks(Ireland). Please follow the local grid code and then choose the corresponding grid standard.

**Normal connect:** The allowed grid voltage/frequency range when the inverter first time connect to the grid.

**Normal Ramp rate:** It is the startup power ramp.

**Reconnect after trip:** The allowed grid voltage /frequency range for the inverter connects the grid after the inverter trip from the grid.

**Reconnect Ramp rate:** It is the reconnection power ramp.

**Reconnection time:** The waiting time period for the inverter connects the grid again.

**PF:** Power factor which is used to adjust inverter reactive power.

**HV1:** Level 1 overvoltage protection point;  
**HV2:** Level 2 overvoltage protection point; ② 0.10s—Trip time.  
**HV3:** Level 3 overvoltage protection point.

**LV1:** Level 1 undervoltage protection point;  
**LV2:** Level 2 undervoltage protection point;  
**LV3:** Level 3 undervoltage protection point.

**HF1:** Level 1 over frequency protection point;  
**HF2:** Level 2 over frequency protection point;  
**HF3:** Level 3 over frequency protection point.

**LF1:** Level 1 under frequency protection point;  
**LF2:** Level 2 under frequency protection point;  
**LF3:** Level 3 under frequency protection point.

**FW:** this series inverter is able to adjust inverter output power according to grid frequency.

**Drop f:** percentage of nominal power per Hz

For example, "Start freq f > 50.2Hz, Stop freq f < 50.2, Drop f = 40%PE/Hz" when the grid frequency reaches 50.2Hz, the inverter will decrease its active power at Drop f of 40%. And then when grid system frequency is less than 50.2Hz, the inverter will stop decreasing output power.

For the detailed setup values, please follow the local grid code.

### Grid Setting/V(W) V(Q)

V(W)  V(Q)

	V1	P1	V2	Q1
V1	100.0%	100%	90.0%	44%
V2	110.0%	20%	95.7%	0%
V3	111.0%	20%	104.0%	0%
V4	115.0%	20%	112.2%	-50%

Lock-in/Pn: 5%    Lock-out/Pn: 20%

Grid Set5

↑ ↓ ✕ ✓

**V(W)**: It is used to adjust the inverter active power according to the set grid voltage.  
**V(Q)**: It is used to adjust the inverter reactive power according to the set grid voltage.  
 This function is used to adjust inverter output power (active power and reactive power) when grid voltage changes.

**Lock-in/Pn 5%**: When the inverter active power is less than 5% rated power, the VQ mode will not take effect.  
**Lock-out/Pn 20%**: If the inverter active power is increasing from 5% to 20% rated power, the VQ mode will take effect again.

For example: V2=110%, P2=20%. When the grid voltage reaches the 110% times of rated grid voltage, inverter output power will reduce its active output power to 20% rated power.

For example: V1=90%, Q1=44%. When the grid voltage reaches the 90% times of rated grid voltage, inverter output power will output 44% reactive output power.

For the detailed setup values, please follow the local grid code.

### Grid Setting/P(Q) P(PF)

P(Q)  P(PF)

	P1	Q1	P2	PF1
P1	0%	0%	0%	-2.400
P2	0%	0%	0%	0.000
P3	0%	0%	0%	0.000
P4	0%	0%	0%	0.000

Lock-in/Pn: 50%    Lock-out/Pn: 50%

Grid Set6

↑ ↓ ✕ ✓

**P(Q)**: It is used to adjust the inverter reactive power according to the set active power.

**P(PF)**: It is used to adjust the inverter PF according to the set active power.

For the detailed setup values, please follow the local grid code.

**Lock-in/Pn 50%**: When the inverter output active power is less than 50% rated power, it won't enter the P(PF) mode.

**Lock-out/Pn 50%**: When the inverter output active power is higher than 50% rated power, it will enter the P(PF) mode.

Note : only when the grid voltage is equal to or higher than 1.05times of rated grid voltage, then the P(PF) mode will take effect.

### Grid Setting/LVRT

LHVR

HV1	115%
LV1	50%

Grid Set7

↑ ↓ ✕ ✓

**Reserved**: This function is reserved.It is not recommended.

# 11.8 The Method of CEI-021 Standard Self-Check



Firstly, tick the "CEI-021" and "Single phase/50Hz" on the grid setting menu.



Secondly, tick "System selfcheck", then it will ask you input the password, and the default password is 1234.

Note: please don't tick "CEI-021 Report".

This "System selfcheck" program is valid only after choosing grid type as "CEI-021".



The default password is 1234  
After input the password and then tick "OK"

Inverter ID : 2012041234	
<b>Self-Test OK</b> <span style="float: right;">8/8</span>	
Testing 59.S1...	Test 59.S1 OK!
Testing 59.S2...	Test 59.S2 OK!
Testing 27.S1...	Test 27.S1 OK!
Testing 27.S2...	Test 27.S2 OK!
Testing 81>S1...	Test 81>S1 OK!
Testing 81>S2...	Test 81>S2 OK!
Testing 81<S1...	Test 81<S1 OK!
Testing 81<S2...	Test 81<S2 OK!

During the self-test process, all the indicators will be on and the alarm keeps on. When all the test items shows OK, which means the self-test is completed successfully.

### Advanced Function

Solar Arc Fault ON

Clear Arc\_Fault

System selfcheck

DRM

Signal ISLAND MODE

EMS\_En\_Stop

Backup Delay

Gain peak-sharing

CT Ratio

CEI-021 Report

↑  
Func  
Set!

↓

✕

✓

then press "esc" button to quit from this page. Tick "system selfcheck" on the Advanced function menu and tick "CEI-021 Report".

### PassWord

1	2	3
4	5	6
7	8	9
CANCEL	0	OK

System selfcheck: After ticking this item, it needs input the password. The default password is 1234. After input the password and then tick "OK"

Inverter ID : 2012041234			
Self-Test Report			
59.S1 threshold	253V	900ms	59.S1: 228V 902ms
59.S2 threshold	264.5V	200ms	59.S2: 229V 204ms
27.S1 threshold	195.5V	1500ms	27.S1: 228V 1508ms
27.S2 threshold	34.5V	200ms	27.S2: 227V 205ms
81>S1 threshold	50.2Hz	100ms	81>S1: 49.9Hz 103ms
81>S2 threshold	51.5Hz	100ms	81>S2: 49.9Hz 107ms
81<S1 threshold	49.8Hz	100ms	81<S1: 50.0Hz 95ms
81<S2 threshold	47.5Hz	100ms	81<S2: 50.1Hz 97ms

This page will shows the test result of "CEI-021 self-check".

## 11.9 Generator Port Use Setup Menu

**Generator input rated power:** allowed Max. power from diesel generator.

**GEN connect to grid input:** connect the diesel generator to the grid input port.

**Smart Load Output:** This mode utilizes the Gen input connection as an output which only receives power when the battery SOC and PV power is above a user programmable threshold.  
**e.g. Power=500W, ON: 100%, OFF=95%:** When the PV power exceeds 500W, and battery bank SOC reaches 100%, Smart Load Port will switch on automatically and power the load connected. When the battery bank SOC < 95% or PV power < 500w, the Smart Load Port will switch off automatically.

### Smart Load OFF Batt

- Battery SOC at which the Smart load will switch off.

### Smart Load ON Batt

- Battery SOC at which the Smart load will switch on. Also, the PV input power should exceed the setting value (Power) simultaneously and then the Smart load will switch on.

**On Grid always on:** When click "on Grid always on" the smart load will switch on when the grid is present.

**off grid immediately off:** the smart load will stop working immediately when the grid is disconnected if this item is active.

**Micro Inv Input:** To use the Generator input port as a micro-inverter on grid inverter input (AC coupled), this feature will also work with "Grid-Tied" inverters.

\* **Micro Inv Input OFF:** when the battery SOC exceeds setting value, Microinverter or grid-tied inverter will shut down.

\* **Micro Inv Input ON:** when the battery SOC is lower than setting value, Microinverter or grid-tied inverter will start to work.

**AC Couple Fre High:** If choosing "Micro Inv input", as the battery SOC reaches gradually setting value (OFF), During the process, the microinverter output power will decrease linear. When the battery SOC equals to the setting value (OFF), the system frequency will become the setting value (AC couple Fre high) and the Microinverter will stop working.

Stop exporting power produced by the microinverter to the grid.

\* **Note:** Micro Inv Input OFF and On is valid for some certain FW version only.

\* **AC couple on load side:** connecting the output of on-grid inverter at the load port of the hybrid inverter. In this situation, the hybrid inverter will not able to show the load power correctly.

\* **AC couple on grid side:** this function is reserved.

\* **Note:** Some firmware versions don't have this function.



## 11.10 Advanced Function Setup Menu

**Advanced Function**

<input type="checkbox"/> Solar Arc Fault ON	Backup Delay	↑
<input type="checkbox"/> Clear Arc_Fault	0ms	Func Set1
<input type="checkbox"/> System selfcheck	<input type="checkbox"/> Gen peak-shaving	↓
<input type="checkbox"/> DRM	CT Ratio	✕
<input type="checkbox"/> Signal ISLAND MODE	2000: 1	✓
<input type="checkbox"/> BMS_Err_Stop	<input type="checkbox"/> CBI 0-21 Report	

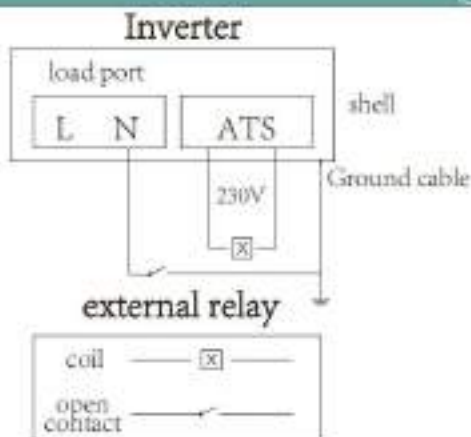

**Solar Arc Fault ON:** Enable the solar arc protection function. Note: This function is optional.

**Clear Arc\_Fault:** Eliminate arc fault and reset. Note: This function is optional.

**Gen Peak-shaving:** Enable When the power of the generator exceeds the rated value of it, the inverter will provide the redundant part to ensure that the generator will not overload.

**DRM:** For AS4777 standard.

**Backup Delay:** When the grid cuts off, the inverter will give output power after the setting time.

For example, backup delay: 3ms. the inverter will give output power after 3ms when the grid cuts off.

Note: for some old FW version, the function is not available.

**BMS\_Err\_Stop:** When it is active, if the battery BMS failed to communicate with inverter, the inverter will stop working and report fault.

**Signal ISLAND MODE:** when "signal island mode" is checked and the inverter connects the grid, the ATS port voltage will be 0. When "signal island mode" is checked and the inverter disconnected from the grid, the ATS port voltage will output 230Vac voltage. With this feature and outside NO type relay, it can realize N and PE disconnection or bond.

More details, please refer to left side picture.

**Advanced Function**

<input type="checkbox"/> DC 1 for WindTurbine	<input type="checkbox"/> DC 2 for WindTurbine	↑		
V1	90V 0.0A	V7	210V 0.0A	Wind Set2
V2	110V 1.5A	V8	230V 10.5A	↓
V3	130V 3.0A	V9	250V 12.0A	✕
V4	150V 4.5A	V10	270V 13.5A	✓
V5	170V 6.0A	V11	290V 15.0A	
V6	190V 7.5A	V12	310V 16.5A	

This is for Wind Turbine

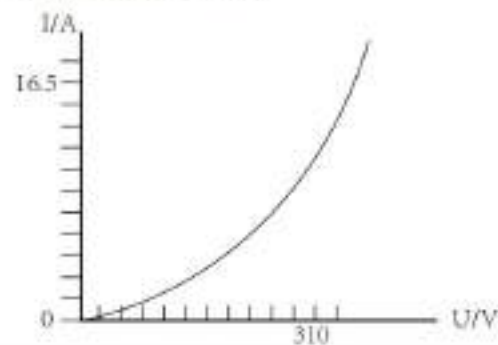

**Advanced Function**

Parallel    Module SN: 00     A Phase  
 Master     B Phase  
 Slave     C Phase

Ex\_Meter For CT    Meter Select: CHNT-3P    OK  
 A Phase    CHNT-1P    Easton-3P    Easton-1P  
 B Phase     Grid Side INV Meter2  
 C Phase

↑ Paral. Set3  
↓  
✕  
✓

**Ex\_Meter For CT:** when in Three phase system with CHNT Three phase energy meter (DTSU666), click corresponding phase where hybrid inverter is connected. e.g. when the hybrid inverter output connects to A phase, please click A Phase.

**Meter Select:** select the corresponding meter type according to the meter installed in the system.

**Grid Side INV Meter2:** when there's a string inverter AC couple at the grid or load side of hybrid inverter and there's a meter installed for the string inverter, then the hybrid inverter LCD will show the string inverter output power on its PV icon. Please make sure the meter can communicate with the hybrid inverter successfully.

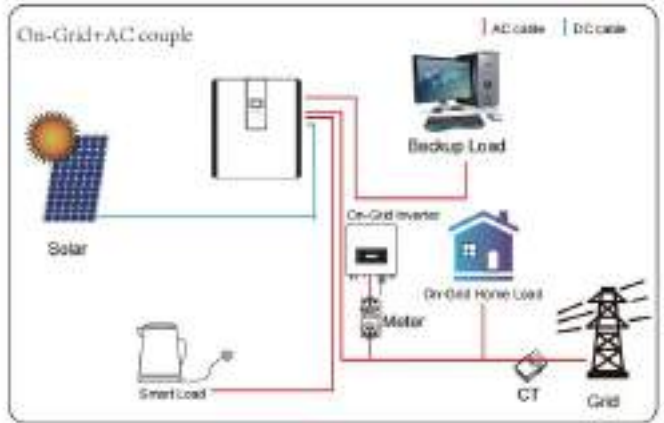
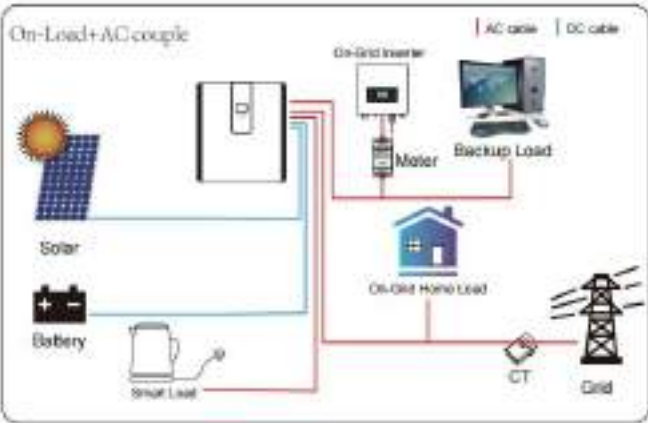

**Advanced Function**

ATS    ON  
 820W    8320V  
 Export power limiter    Import power limiter

Low Noise Mode  
 Low Power Mode<Low Batt  
 MPPT Multi-Point Scanning

↑ Func Set4  
↓  
✕  
✓

**ATS:** It is related with ATS port voltage. it is better in "uncheck" position.

**Export power limiter:** It is used to setup the allowed the maximum output power to flow to grid.

**Import power limiter:** when it is active, the grid output power will be limited. its priority is lower then "grid peak shaving" if the "grid peak shaving" is selected.

**Low Noise Mode:** In this mode, inverter will work in "low noise mode".

**Low Power Mode<Low Batt:** if selected and when battery SOC is less then "Low Batt" value, the self-consumption power of inverter will be from grid and battery simultaneously. If unselected, the self-consumption power of inverter will be mainly from grid.

**MPPT Multi-Point Scanning:** it will check whether the I/V of PV is working on its Max. power point. If not, then it will adjust I/V to the Max. power point.

### 11.11 Device Info Setup Menu

**Device Info.**

Inverter ID: 1601012001    Flash  
 HMI\_Ver:0302    MAIN\_Ver:0-5213-0717

Alarms Code	Occurred
F64 Heatsink_HighTemp_Fault	2019-03-11 15:56
F64 Heatsink_HighTemp_Fault	2019-03-08 10:46
F64 Heatsink_HighTemp_Fault	2019-03-08 10:45

↑ Device Info  
↓  
✕  
✓

This page show Inverter ID, Inverter version and alarm codes.

**HMI:** LCD version

**MAIN:** Control board FW version

## 12.Fault Content

### 12.1 Fault Information and Processing

The energy storage inverter is designed according to the grid-connected operation standard and meets the safety requirements and electromagnetic compatibility requirements. Before leaving the factory, the inverter undergoes several rigorous tests to ensure that the inverter can operate reliably.



If any of the fault messages listed in Chart12-1 appear on your inverter and the fault has not been removed after restarting, please contact your local dealer or service center. you need to have the following information ready.

1. Inverter serial number;
2. Distributor or service center of the inverter ;
3. on-grid power generation date;
4. The problem description (including the fault code and indicator status displayed on the LCD) is as detailed as possible.
5. your contact information. In order to give you a clearer understanding of the inverter's fault information, we will list all possible fault code sand their descriptions when the inverter is not working properly.

### 12.2 Low Voltage Fault Analysis Method

The cloud platform or LCD displays the hexadecimal value of the original fault. Each Bit indicates a fault. 1 indicates yes and 0 indicates none.

0x0000 0x0000  
0x0000 0x0000

The preceding data corresponds to CAN packets in the PCS CAN communication protocol.  
Corresponding CAN packet:

byte0、 1 byte2、 3  
byte4、 5 byte6、 7

For example, parsing red fonts fails and converting them to binary  
That is: byte0: bit7 bit6 bit5 bit4 bit3 bit2 bit1 bit0

Bit7	Bit6	Bit5	Bit4	Bit	Bit2	Bit1	Bit0
Cell under temperature (Charge) (Errcode:8)	Cell over temperature (Charge) (Errcode:7)	Discharge Over Current (Errcode:6)	Charge over Current (Errcode:5)	Reserved	Reserved	Cell under voltage (Errcode:2)	Cell over Voltage (Errcode:1)

Byte1: bit7 bit6 bit5 bit4 bit3 bit2 bit1 bit0

Bit7	Bit6	Bit5	Bit4	Bit3	Bit2	Bit1	Bit0
Reserved	Reserved	Heating film over Temperature (Errcode:14)	Mos over temperature (Errcode:13)	Cell temperature over Difference (Errcode:12)	Cell voltage over difference (Errcode:11)	Reserved	Reserved

For example, parse blue font failure and convert it to binary  
That is: byte2: bit7 bit6 bit5 bit4 bit3 bit2 bit1 bit0

Bit7	Bit6	Bit5	Bit4	Bit3	Bit2	Bit1	Bit0
AFE-SCDL (Errcode:24)	Reserved	Reserved	Reserved	Reserved	AFE-OC DL/OCD1/OCD2 (Errcode:19)	Reserved	Reserved

Byte3: bit7 bit6 bit5 bit4 bit3 bit2 bit1 bit0

Bit7	Bit6	Bit5	Bit4	Bit3	Bit2	Bit1	Bit0
Master Address Repeat (Errcode:31)	PCS communication Fail (Errcode:30)	Internal communication Fail (Errcode:30)	EEPROM error (Errcode:29)	Mosfet short circuit (Errcode:28)	Temperature Sampling fail (Errcode:27)	Cell voltage Sampling fail (Errcode:26)	AFE communication Fail (Errcode:25)

For example, parse the purple font failure and convert it to binary.  
That is: byte4: bit7 bit6 bit5 bit4 bit3 bit2 bit1 bit0

Bit7	Bit6	Bit5	Bit4	Bit3	Bit2	Bit1	Bit0
Reserved	Reserved	Reserved	Reserved	Reserved	Reserved	Reserved	Reserved

Byte5: bit7 bit6 bit5 bit4 bit3 bit2 bit1 bit0

Bit7	Bit6	Bit5	Bit4	Bit3	Bit2	Bit1	Bit0
Heat Error (Errcode:2)	Heat Mos Adhesion (Errcode:1)	Reserved	Reserved	Reserved	Reserved	Reserved	Reserved

For example, parse the green font failure and convert it to binary

That is: byte6: bit7 bit6 bit5 bit4 bit3 bit2 bit1 bit0

Bit7	Bit6	Bit5	Bit4	Bit3	Bit2	Bit1	Bit0
CHG_VOLT _LOW  (Errcode:8)	TEMP_OPE N_WIRE_F AIL  (Errcode:7)	VOLT_OP EN_WIRE_ FAIL  (Errcode:6)	FUSE Blown  (Errcode:5)	OverTermi nalTemp	Charge Inversed  (Errcode:4)	Pre Charge Failed  (Errcode:3)	OverConnect Temp

Byte7: Disable

Error code	Description	Solutions
F08	GFDI_Relay_Failure	1.When inverter is in Split phase(120/240Vac)or three-phase system (120/208Vac) system,the back up load port N line needs to connect ground; 2.If the fault still exists,please contact us for help.
F13	Working mode change	1.When the grid type and frequency changed it will report F13; 2.When the battery mode was changed to “No battery”mode, it will report F13; 3.For some old FW version,it will reportF13 when the system work mode changed; 4,Generally,it will disappear automatically when shows F13; 5.If still same,and turn off the DC switch and AC switch and wait for one minute and then turn on the DC/AC switch; 6.Seek help from us,if can not go back to normal state.
F18	AC over current fault of hardware	AC side over current fault 1.Please check whether the back up load power and common load power are within the range; 2.Restart and check whether it is in normal; 3.Seek help from us,if can not go back to normal state.
F20	DC over current fault of the hardware	DC side over current fault 1.Check PV module connect and battery connect; 2.When in the off-grid mode,the inverter startup with big power load,it may report F20.Please reduce the load power connected; 3.Turn off the DC switch and AC switch and then wait one minute,then turn on the DC/AC switch again; 4.Seek help from us,if can not go back to normal state
F22	Tz_EmergStop_Fault	Please contact your installer for help.
F23	AC leakage current is transient over current	Leakage current fault 1.Check PV side cable ground connection. 2.Restart the system 2~3 times. 3.If the fault still exists,please contact us for help.
F24	DC insulation impedance failure	PV isolation resistance is too low 1.Check the connection of PV panels and inverter is firmly and

		<p>correctly;</p> <p>2.Check whether the PE cable of inverter is connected to ground;</p> <p>3.Seek help from us,if can not go back to normal state.</p>
F26	The DC busbar is unbalanced	<p>1.Please wait for a while and check whether it is normal;</p> <p>2.When the hybrid in split phase mode,and the load of L1 and load of L2 is big different,it will report the F26.</p> <p>3.Restart the system 2~3 times.</p> <p>4.Seek help from us,if can not go back to normal state.</p>
F29	Parallel CANBus fault	<p>1.When in parallel mode,check the parallel communication cable connection and hybrid inverter communication address setting;</p> <p>2.During the parallel system start up period,inverters will report F29. when all inverters are in ON status,it will disappear automatically;</p> <p>3.If the fault still exists,please contact us for help.</p>
F34	AC Over current fault	<p>1.Check the backup load connected,make sure it is in allowed power range;</p> <p>2.If the fault still exists,please contact us for help.</p>
F35	No AC grid	<p>No Utility</p> <p>1.Please confirm grid is lost or not;</p> <p>2.Check the grid connection is good or not;</p> <p>3.Check the switch between inverter and grid is on or not;</p> <p>4.Seek help from us,if can not go back to normal state.</p>
F41	Parallel system stop	<p>1.Check the hybrid inverter working status.If there's 1 pcs hybrid inverter is in OFF status,the other hybrid inverters may report F41 fault in parallel system.</p> <p>2.If the fault still exists,please contact us for help.</p>
F42	AC line low voltage	<p>Grid voltage fault</p> <p>1.Check the AC voltage is in the range of standard voltage in specification;</p> <p>2.Check whether grid AC cables are firmly and correctly connected;</p> <p>3.Seek help from us,if can not go back to normal state</p>
F47	AC over frequency	<p>Grid frequency out of range</p> <p>1.Check the frequency is in the range of specification or not;</p> <p>2.Check whether AC cables are firmly and correctly connected;</p> <p>3.Seek help from us,if can not go back to normal state.</p>
F48	AC lower frequency	<p>Grid frequency out of range</p> <p>1.Check the frequency is in the range of specification or not;</p> <p>2.Check whether AC cables are firmly and correctly connected;</p> <p>3.Seek help from us,if can not go back to normal state.</p>
F56	DC busbar voltage is too low	<p>Battery voltage low</p> <p>1.Check whether battery voltage is too low;</p> <p>2.If the battery voltage is too low,using PV or grid to charge the battery;</p> <p>3.Seek help from us,if can not go back to normal state.</p>
F58	BMS communication fault	<p>1.it tells the communication between hybrid inverter and battery BMS disconnected when "BMS_Err-Stop" is active;</p> <p>2.if don't want to see this happen,you can disable "BMS_Err-Stop" item on the LCD;</p> <p>3.If the fault still exists,please contact us for help.</p>
F63	ARC fault	<p>1.ARC fault detection is only for US market;</p> <p>2.Check PV module cable connection and clear the fault;</p> <p>3.Seek help from us,if can not go back to normal state.</p>

F64	Heat sink high temperature failure	Heat sink temperature is too high 1.Check whether the work environment temperature is too high; 2.Turn off the inverter for 10mins and restart; 3.Seek help from us,if can not go back to normal state.
-----	------------------------------------	--

Chart 12-1 Fault information

Under the guidance of our company,customers return our products so that our company can provide service of maintenance or replacement of products of the same value.Customers need to pay the necessary freight and other related costs.Any replacement or repair of the product will cover the remaining warranty period of the product.If any part of the product or product is replaced by the company itself during the warranty period,all rights and interests of there placement product or component belong to the company.

Factory warranty does not include damage due to the following reasons:

- Damage during transportation of equipment;
- Damage caused by incorrect installation or commissioning;
- Damage caused by failure to comply with operation instructions,installation instructions or maintenance instructions;
- Damage caused by attempts to modify,alter or repair products;
- Damage caused by incorrect use or operation;
- Damage caused by insufficient ventilation of equipment;
- Damage caused by failure to comply with applicable safety standards or regulations;
- Damage caused by natural disasters or force majeure (e.g.floods,lightning,over voltage,storms,fires,etc.)

In addition,normal wear or any other failure will not affect the basic operation of the product.Any external scratches,stains or natural mechanical wear does not represent a defect in the product.

## 13.FAQ

### **Q1: What type of battery does the product use? Is it safe?**

Use high-quality lithium iron phosphate batteries. system multiple protection strategy, charge overload protection, discharge overload protection, to ensure the safe and normal operation of the battery.

### **Q2: How to judge the product in charge and discharge?**

When charging, the LCD display displays the remaining charging time, the power indicator chart outside the battery power percentage starts to rotate, and displays the input power. LED lights flicker on charge and discharge.

### **Q3: How to clean this product?**

Please use a dry, soft, clean cloth or paper towel to wipe the product.

### **Q4: How to store products?**

When storing please turn off the power supply of the product, and then store the product in a dry, ventilated and suitable temperature environment. Do not store the product in an environment that is not conducive to the storage of the product, such as humidity, high temperature, large dust and high salinity, So as to avoid damage to the product. For long-term storage, it is recommended that the battery of this product be discharged to 50% and then charged to 100%for about one month. To extend the service life of this product.



## 14.After-Sales Service

During the use of the product, according to the normal operation of the user manual can not discharge the fault, please contact the dealer in time, and give clear feedback to the after-sales personnel: product model, purchase date, contact phone number, fault phenomenon.

1.Limited warranty, refer to the relevant warranty statement for details. In order to determine the date of purchase, consumers are asked to save the purchase of relevant bills and online shopping records.

2.During the warranty period, due to the damage caused by the product process or materials and non-human reasons, the company undertakes free maintenance and parts replacement obligations.

3.The following conditions are not covered by the warranty:

- ①unauthorized disassembly and maintenance;
- ②product performance failure due to human reasons;
- ③Damage caused by irresistible factors such as natural disasters, lightning, accidents;
- ④Appearance damage after use is not covered by warranty;

## 15.EU Declaration of Conformity

Within the scope of the EU directives

Restriction of the use certain hazardous substances 2011 / 65 / EU (ROHS)

Radio Equipment Directive 2014/53/EU (RED)



NINGBO DEYE ESS TECHNOLOGY CO. , LTD. confirms herewith that the products described in this document are in compliance with the fundamental requirements and other relevant provisions of the above mentioned directives. The entire EU Declaration of Conformity and certificate can be found at <https://deyeess.com>.

# EU Declaration of Conformity

Product: All-in-one Energy Storage System  
System model: RW-F5.3-1H3、RW-F5.3-2H3

Name and address of the manufacturer: NINGBO DEYE ESS TECHNOLOGY CO., LTD.  
No.568, South Rixian Road, Binhai Economic Development Zone, Cixi, Ningbo, Zhejiang, P.R.China

This declaration of conformity is issued under the sole responsibility of the manufacturer. Also this product is under manufacturer's warranty.

This declaration of conformity is not valid any longer: if the product is modified, supplemented or changed in any other way, as well as in case the product is used or installed improperly.

The object of the declaration described above is in conformity with the relevant Union harmonization legislation:

The restriction of the use of certain hazardous substances (RoHS) Directive 2011/65/EU and the Radio Equipment Directive (RED) 2014/53/EU.

References to the relevant harmonized standards used or references to the other technical specifications in relation to which conformity is declared:

EN 62109-1:2010	●
EN 62109-2:2011	●
EN 62920:2017/A1:2021	●
ETSI EN 300 328 V2.2.2(2019-07)	●
ETSI EN 301 489-1 V2.2.3(2019-11)	●
ETSI EN 301 489-17 V3.2.4(2020-09)	●
EN 50665:2017	●
EN IEC 62311:2020	●
EN 55011:2016/A2:2021	●
EN IEC 61000-6-1:2019	●
EN IEC 61000-6-3:2021	●
EN IEC 61000-6-2:2019	●
EN IEC 61000-6-4:2019	●
EN IEC 61000-3-2:2019+A1:2021	●
EN 61000-3-3:2013/A2:2021/AC:2022-01	●
EN IEC 61000-3-11:2019	●
EN 61000-3-12:2011	●

Nom et Titre / Name and Title:

KunLei Yu

Test Manager

 宁波德业储能科技有限公司  
NINGBO DEYE ESS TECHNOLOGY CO., LTD

Au nom de / On behalf of:

NINGBO DEYE ESS TECHNOLOGY CO., LTD.

Date / Date (yyyy-mm-dd):

2024-8-14

A / Place :

Ningbo, China

EU DoC-v1

NINGBO DEYE ESS TECHNOLOGY CO., LTD

