

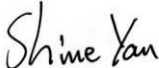

中国认可
国际互认
检测
TESTING
CNAS L5313

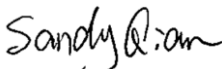

TEST REPORT CEI 0-21 Reference technical rules for the connection of active and passive users to the LV networks of electrical distribution companies	
Report	
Report Number	6163981.51
Date of issue.....	2023-07-24
Total number of pages	355 pages
Testing Laboratory	DEKRA Testing and Certification (Suzhou) Co., Ltd.
Address	No. 99, Hongye Road, Suzhou Industrial Park Suzhou, 215006, P.R. China
Applicant's name	V-TAC EUROPE LTD
Address	Viale Karavelov 9B, Plovdiv 4000, Bulgaria
Test specification:	
Standard.....	CEI 0-21:2022-03
Test procedure	Type test
Non-standard test method.....	N/A
Test Report Form No.	CEI 0-21_V3.0
Test Report Form(s) Originator	DEKRA Testing and Certification (Suzhou) Co., Ltd.
Master TRF	Dated 2022-04
Test item description	Hybrid Inverter
Trade Mark	
Manufacturer	V-TAC EUROPE LTD Viale Karavelov 9B, Plovdiv 4000, Bulgaria
Model/Type reference	VT-6607100, VT-6607101, VT-6607102, VT-6607125, VT-6607133-1, VT-6607136-1, VT-6607133, VT-6607136, VT-6607104, VT-6607146, VT-6607105, VT-6607155, VT-6607106, VT-6607111, VT-6607115, VT-6607120, VT-6607124, VT-6607134, VT-6607137, VT-6607144, VT-6607147, VT-6607150, VT-6607156, VT-6607160
Ratings	See product marking plate on page 4 and ratings of the test products in page 9 to 13.







Responsible Testing Laboratory (as applicable), testing procedure and testing location(s):		
<input checked="" type="checkbox"/>	Testing Laboratory:	DEKRA Testing and Certification (Suzhou) Co., Ltd.
Testing location/ address :		No. 99, Hongye Road, Suzhou Industrial Park Suzhou, 215006, P.R. China
<input type="checkbox"/>	Associated Testing Laboratory:	
Testing location/ address :		
Tested by (name, function, signature) :		Shine Yan (ENG) 
Approved by (name, function, signature) .. :		Sandy Qian (REW) 
<hr/>		
<input type="checkbox"/>	Testing procedure: CTF Stage 1:	
Testing location/ address :		
Tested by (name, function, signature) :		
Approved by (name, function, signature) .. :		
<hr/>		
<input type="checkbox"/>	Testing procedure: CTF Stage 2:	
Testing location/ address :		
Tested by (name + signature) :		
Witnessed by (name, function, signature) .. :		
Approved by (name, function, signature) .. :		
<hr/>		
<input type="checkbox"/>	Testing procedure: CTF Stage 3:	
<input type="checkbox"/>	Testing procedure: CTF Stage 4:	
Testing location/ address :		
Tested by (name, function, signature) :		
Witnessed by (name, function, signature) .. :		
Approved by (name, function, signature) .. :		
Supervised by (name, function, signature) :		

List of Attachments (including a total number of pages in each attachment):	
Annex 1: ISO 9001 certificate (1 pages)	
Annex 2: IEC 62619 Certificate for used battery (3 pages)	
Annex 3: Datasheet of the relay (2 pages)	
Annex 4: Pictures of the unit (9 pages)	
Summary of testing:	
Tests performed (name of test and test clause):	Testing location:
All tests (except clause A.4.6 EMC tests)	DEKRA Testing and Certification (Suzhou) Co., Ltd. No.99, Hongye Road, Suzhou Industrial Park, Suzhou, Jiangsu, P.R. China
A.4.6 EMC tests (The EMC test reports provided by the customer)	<ol style="list-style-type: none"> 1. Intertek Testing Services Shanghai Building No.86, 1198 Qinzhou Road (North), Caohejing Development Zone, Shanghai 200233, China Report No.: 2306A0367SHA-001 Accreditation Number: 3309.02 (A2LA-ILAC) 2. Shanghai Inspection and Testing Institute of Instruments and Automation Systems Co., Ltd. No.103, Caobao Road, Xuhui District, Shanghai, China Report No.: J23-201-WT Accreditation Number: L0130 (CNAS-ILAC)

Copy of marking plate:

The artwork below may be only a draft. The use of certification marks on a product must be authorized by the respective NCBs that own these marks.

Marking label:

V-TAC Meaningful Innovation.	VT-6607106
INVERTER SOLARE IBRIDO	SKU: 11514
Parametri di ingresso del fotovoltaico	
Tensione di ingresso del MPPT:	80-500V
Vmax PV:	550V
Corrente massima in ingresso:	18.5x2A
Isc PV:	26x2A
Parametri di ingresso/uscita AC	
Potenza apparente nominale:	6kVA
Corrente nominale:	27.3/26.1A
Tensione nominale:	da 198 a 242 a 220/ da 207 a 253 a 230 V
Frequenza nominale:	50/60Hz
Fattore di potenza:	1 (-0.8~+0.8 regolabile)
Parametri della batteria	
Tipo di batteria:	ioni di litio/acido di piombo, ecc.
Tensione di ingresso della batteria:	40V-60V
Tensione di spegnimento:	39.5V
Tensione massima di carica:	60V
Tensione massima di protezione:	62V
Corrente di carica continua massima:	80A
Corrente di scarica massima:	80A
Sistema	
Classe di protezione:	Class I
Tipo di isolamento:	senza trasformatore
Grado di protezione:	IP65
Categoria di sovratensione:	OVC III (AC), OVC II (PV)
Dimensioni (L*A*P):	370*513*192 mm
Weight:	17kg
Massima efficienza:	97.6%
 	
  	
5 ANNI DI GARANZIA	
V-TAC EUROPE LTD Viale Karavelov 9B, Plovdiv 4000, Bulgaria	

Remark: According to customer's requirement, these models were evaluated under the grid frequency of 50 Hz.

Warning label:

WARNING



Hot surfaces

To reduce the risk of burns. Do not touch.



Risk of electric shock

Both AC and DC voltage sources are terminated inside this equipment. Each circuit must be individually disconnected before servicing and when the photovoltaic array is exposed to light, it supplies a DC voltage to this equipment.



Risk of electric shock from energy stored in capacitor. Do not remove cover until 5 minutes after disconnecting all sources of supply.



Risk of electric shock, do not remove cover. No user serviceable parts inside. Refer servicing to qualified service personnel.



Check user manual before service

Refer to the operation instruction.



NO warranty for disassembled inverter

Warranty doesn't provide for the inverter disassembled by non-authorized staff.



WARNING:

POWER FED FROM MORE THAN ONE SOURCE

For continued protection against risk of fire, replace only with same type and ratings of fuse.

Test item particulars:				
Equipment mobility	movable <u>fixed</u>	hand-held transportable	stationary for building-in	
Connection to the mains	pluggable equipment <u>permanent connection</u>		direct plug-in for building-in	
Environmental category	<u>outdoor</u>	indoor unconditional	indoor conditional	
Over voltage category Mains.....	OVC I	OVC II	<u>OVC III</u>	OVC IV
Over voltage category PV	OVC I	<u>OVC II</u>	OVC III	OVC IV
Mains supply tolerance (%).....	-85 / +115 %			
Tested for power systems	TN			
IT testing, phase-phase voltage (V)	N/A			
Class of equipment.....	<u>Class I</u> Not classified	Class II	Class III	
Mass of equipment (kg)	Max 17 kg			
Pollution degree	Outside PD3; Inside PD2			
IP protection class	IP65			
Possible test case verdicts:				
- test case does not apply to the test object	N/A			
- test object does meet the requirement.....	P (Pass)			
- test object does not meet the requirement	F (Fail)			
- this clause is information reference for installation....	Info.			
Testing:				
Date of receipt of test item	2022-06-09 (samples provided by applicant) 2022-11-07 (Amendment 1 report) No sample (Amendment 2 report) No sample (Amendment 3 report)			
Date (s) of performance of tests	2022-06-09 to 2022-10-24 2022-11-07 to 2023-06-29 (Amendment 1 report) No tests (Amendment 2 report) No tests (Amendment 3 report)			
General remarks:				
The test results presented in this report relate only to the object tested. This report shall not be reproduced, except in full, without the written approval of the Issuing testing laboratory. "(see Enclosure #)" refers to additional information appended to the report. "(see appended table)" refers to a table appended to the report. The clause A.4.6 EMC tests are not in the CNAS scope of DEKRA Testing and Certification (Suzhou) Co., Ltd. Throughout this report a <input type="checkbox"/> comma / <input checked="" type="checkbox"/> point is used as the decimal separator. Determination of the test result includes consideration of measurement uncertainty from the test equipment and methods.				
Name and address of factory (ies):				
Afore New Energy Technology (Shanghai) Co., Ltd. Building 7, No.333 Wanfang Rd, Minhang District, Shanghai, China				

General product information:

The products under test are single phase Hybrid inverter and non-isolated between PV and AC output that convert DC voltage into AC voltage and feed it into the low-voltage public grid or supply local load.

The off grid port is grounding when the unit workings at stand alone mode by relay. The final used earth System shall comply the local code requirement.

The input and output are protected by varistors to earth. The unit is providing EMC filtering at the input and output towards mains. The output is switched off redundant by the high power switching bridge and two relay in series. This assures that the opening of the output circuit will also operate in case of one error.

Description of the power circuit:

The internal control is redundant built, it consists of master controller and slave controller, the master controller can control relays, measures voltage, frequency, AC current with injected DC, insulation resistance and residual current. The slave controller can control the relays, measures the voltage and frequency. Both controllers communicate with each other.

The voltage and frequency measurement achieved with resistors in serial, which are connected directly to line and neutral. Both controllers get these signals and calculate the data.

The unit provides two relays in series in each phase. The relays were test before each start up. In addition, both controllers can stop the power bridge.

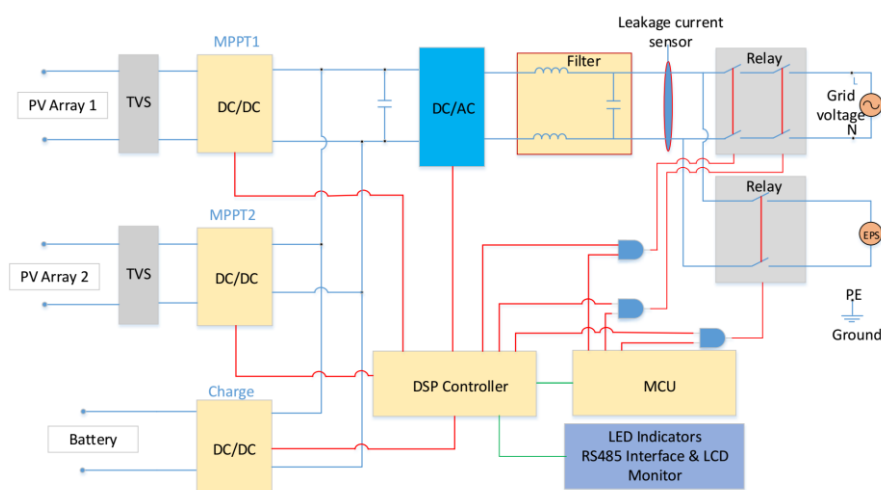
Block Diagram**Model difference:**

- 1) The model VT-6607100, VT-6607101, VT-6607102, VT-6607125, VT-6607133-1, VT-6607136-1 have single MPPT input channel and are identical in hardware and just derating power by software.
- 2) The model VT-6607133, VT-6607136, VT-6607104, VT-6607146, VT-6607105, VT-6607155, VT-6607106 have dual MPPT input channel and are identical in hardware and just derating power by software.
- 3) The model VT-6607111, VT-6607115, VT-6607120, VT-6607124, VT-6607134, VT-6607137, VT-6607144, VT-6607147, VT-6607150, VT-6607156, VT-6607160 have no PV input circuit and are identical in hardware and just derating power by software.

The product was tested on:

Hardware version: V06

Software version: V06

Amendment 1:

The report 6159211.50 was based on the report 6136775.50 issued by DEKRA Testing and Certification (Suzhou) Co., Ltd., issued on 2022-12-16, and COC No.: 6136775.01 issued by DEKRA Testing and Certification (Shanghai) Ltd., issued on 2022-12-16. It was issued due to below modifications:

---Change the specification of the battery.

After technical review, tests were considered necessary, see the "summary of testing".

Amendment 2:

The report 6163981.50 was based on the report 6159211.50 issued by DEKRA Testing and Certification (Suzhou) Co., Ltd., issued on 2023-07-03, and COC No.: 6159211.01 issued by DEKRA Testing and Certification (Shanghai) Ltd., issued on 2023-07-03. It was issued due to below modifications:

- Update the the applicant, manufacture, trade mark, model names and the marking plate.
- Update the ISO 9001 certificate.

After technical review, tests were not considered necessary.

Amendment 3:

The report 6163981.51 was based on the report 6163981.50 issued by DEKRA Testing and Certification (Suzhou) Co., Ltd., issued on 2023-07-10, and COC No.: 6163981.01 issued by DEKRA Testing and Certification (Shanghai) Ltd., issued on 2023-07-11. It was issued due to below modifications:

- Change the model from VE48100E to VT48100E-P2, which is exactly the same, only with different model names.

After technical review, tests were not considered necessary.

Model list / Ratings of the test product:						
Models	VT-6607100	VT-6607101	VT-6607102	VT-6607125	VT-6607133-1	VT-6607136-1
PV input:						
Max PV voltage (V)	550					
MPPT voltage range (V)	80-500					
Max PV current (A)	18.5					
Isc PV (A)	26					
Max PV power (W)	1500	2300	3000	3800	4500	5400
Battery port:						
Battery type	Li-ion / Lead-acid					
Battery normal voltage (range) (Vdc)	51.2 (40-60)					
Max charge/discharge current (A)	25	40	50	63	80	80
Max charge/discharge power (W)	1000	1500	2000	2500	3000	3600
AC grid (input and output):						
Rated voltage (V)	L/N/PE, 230Vac					
Rated frequency (Hz)	50					
Max AC current (A)	5	7	10	12	14	17
Rated AC power (W)	1000	1500	2000	2500	3000	3600
Max AC apparent power (VA)	1000	1500	2000	2500	3000	3600
Power factor range	1.0 (-0.8~ +0.8 adjustable)					
AC load output (stand alone):						
Rated voltage (V)	L/N/PE, 230Vac					
Rated frequency (Hz)	50					
Max AC current (A)	5	7	10	12	14	17
Rated continuous AC power (W)	1000	1500	2000	2500	3000	3600
Max continuous AC apparent power (VA)	1000	1500	2000	2500	3000	3600
General:						
Protection class	I					
Degree of protection	IP65					
Overvoltage category	II(DC), III(AC)					
Ambient temperature	-25...+60°C (Derating > 45°C)					

Models	VT-6607133	VT-6607136	VT-6607104	VT-6607146	VT-6607105	VT-6607155	VT-6607106
PV input:							
Max PV voltage (V)	550						
MPPT voltage range (V)	80-500						
Max PV current (A)	18.5 x 2						
Isc PV (A)	26 x 2						
Max PV power (W)	4500	5400	6000	6900	7500	8300	9000
Battery port:							
Battery type	Li-ion / Lead-acid						
Battery normal voltage (range) (Vdc)	51.2 (40-60)						
Max charge/discharge current (A)	80						
Max charge/discharge power (W)	3000	3600	4000	4600	4800	4800	4800
AC grid (input and output):							
Rated voltage (V)	L/N/PE, 230Vac						
Rated frequency (Hz)	50						
Max AC current (A)	14	17	19	22	23	26	28
Rated AC power (W)	3000	3600	4000	4600	5000	5500	6000
Max AC apparent power (VA)	3000	3600	4000	4600	5000	5500	6000
Power factor range	1.0 (-0.8~ +0.8 adjustable)						
AC load output (stand alone):							
Rated voltage (V)	L/N/PE, 230Vac						
Rated frequency (Hz)	50						
Max AC current (A)	14	17	19	22	23	26	28
Rated continuous AC power (W)	3000	3600	4000	4600	5000	5500	6000
Max continuous AC apparent power (VA)	3000	3600	4000	4600	5000	5500	6000
General:							
Protection class	I						
Degree of protection	IP65						
Overvoltage category	II(DC), III(AC)						
Ambient temperature	-25...+60°C (Derating > 45°C)						

Models	VT-6607111	VT-6607115	VT-6607120	VT-6607124	VT-6607134	VT-6607137
Battery port:						
Battery type	Li-ion / Lead-acid					
Battery normal voltage (range) (Vdc)	51.2 (40-60)					
Max charge/discharge current (A)	25	40	50	63	80	80
Max charge/discharge power (W)	1000	1500	2000	2500	3000	3600
AC grid (input and output):						
Rated voltage (V)	L/N/PE, 230Vac					
Rated frequency (Hz)	50					
Max AC current (A)	5	7	10	12	14	17
Rated AC power (W)	1000	1500	2000	2500	3000	3600
Max AC apparent power (VA)	1000	1500	2000	2500	3000	3600
Power factor range	1.0 (-0.8~ +0.8 adjustable)					
AC load output (stand alone):						
Rated voltage (V)	L/N/PE, 230Vac					
Rated frequency (Hz)	50					
Max AC current (A)	5	7	10	12	14	17
Rated continuous AC power (W)	1000	1500	2000	2500	3000	3600
Max continuous AC apparent power (VA)	1000	1500	2000	2500	3000	3600
General:						
Protection class	I					
Degree of protection	IP65					
Overvoltage category	II(DC), III(AC)					
Ambient temperature	-25...+60°C (Derating > 45°C)					

Models	VT-6607144	VT-6607147	VT-6607150	VT-6607156	VT-6607160
Battery port:					
Battery type	Li-ion / Lead-acid				
Battery normal voltage (range) (Vdc)	51.2 (40-60)				
Max charge/discharge current (A)	80	80	100	120	120
Max charge/discharge power (W)	4000	4600	5000	5500	6000
AC grid (input and output):					
Rated voltage (V)	L/N/PE, 230Vac				
Rated frequency (Hz)	50				
Max AC current (A)	19	22	23	26	28
Rated AC power (W)	4000	4600	5000	5500	6000
Max AC apparent power (VA)	4000	4600	5000	5500	6000
Power factor range	1.0 (-0.8~ +0.8 adjustable)				
AC load output (stand alone):					
Rated voltage (V)	L/N/PE, 230Vac				
Rated frequency (Hz)	50				
Max AC current (A)	19	22	23	26	28
Rated continuous AC power (W)	4000	4600	5000	5500	6000
Max continuous AC apparent power (VA)	4000	4600	5000	5500	6000
General:					
Protection class	I				
Degree of protection	IP65				
Overvoltage category	II(DC), III(AC)				
Ambient temperature	-25...+60°C (Derating > 45°C)				

Type of generating unit:

Static Conversion Device <i>Dispositivo di conversione statica</i>	Interface Protection <i>Protezione di interfaccia</i>	Interface Protection Device <i>Dispositivo di interfaccia</i>	Rotating Generator Device <i>Dispositivo di generazione rotante</i>
Yes/Sì	Yes/Sì	Yes/Sì	No

The battery used for testing with the Hybrid Inverter:

Battery Models	VE51100RS, VE51100W, VT48100E-P2, VT48100E-W			
Manufacturer	Hangzhou Vestwoods Technology Co., LTD			
Number of battery module in parallel	1	2	3	4
Nominal Voltage	51.2 V			
Nominal capacity	100 Ah	200 Ah	300 Ah	400 Ah
CUS (Storage system useful capacity)	5.12 kWh	10.24 kWh	15.36 kWh	20.48 kWh
Number of battery module in parallel	5	6	7	8
Nominal Voltage	51.2 V			
Nominal capacity	500 Ah	600 Ah	700 Ah	800 Ah
CUS (Storage system useful capacity)	25.6 kWh	30.72 kWh	35.84 kWh	40.96 kWh
Number of battery module in parallel	9	10	11	12
Nominal Voltage	51.2 V			
Nominal capacity	900 Ah	1000 Ah	1100 Ah	1200 Ah
CUS (Storage system useful capacity)	46.08 kWh	51.2 kWh	56.32 kWh	61.44 kWh
Number of battery module in parallel	13	14	15	16
Nominal Voltage	51.2 V			
Nominal capacity	1300 Ah	1400 Ah	1500 Ah	1600 Ah
CUS (Storage system useful capacity)	66.56 kWh	71.68 kWh	76.8 kWh	81.92 kWh
Remark:	<p>The CB test certificate No. of the battery: DE 7-0774, JPTUV-148854, JPTUV-145410</p> <p>When the batteries are connected in parallel, the charge/ discharge current is superimposed and is limited by the maximum current of the battery port of the Hybrid Inverter.</p> <p>The batteries are not integrated into the Hybrid Inverter and must be installed according to the local regulations.</p> <p>The electrical performance of the four models of batteries (VE51100RS, VE51100W, VT48100E-P2, VT48100E-W) is the same. The four models of batteries only differ in appearance, size, and weight to meet different installation needs.</p>			

Clause	Test Item	Remark	P / F / N/A
A.4.3.1 & A.4.3.2	Test procedure for maximum/minimum frequency		P
A.4.3.1 & A.4.3.2	Test procedure for maximum/minimum voltage		P
A.4.3.3.1	Insensitivity to harmonics of the frequency relay		P
A.4.3.3.2	Remote trip signal		P
A.4.3.3.3	Communication Signal		P
A.4.3.4	Verification of insensitivity to the frequency derivative		P
A.4.4	Self -test		P
A.4.5	Single fault tolerance		P
A.4.7	Climatic compatibility tests		P
A.4.8	Insulation tests (CEI EN 60255-5)		P
A.4.9	Test for the overload capacity of measuring circuits		P
A.4.11	Automatic mechanism to prevent current imbalance during production		N/A
B.1 a)/b)	Harmonic current emission		P
B.1 c)	Flicker emission		P
B.1.1	Conditions of connection, reconnection and gradual power supply		P
B.1.2.2.1	Reactive power capability - Inverter in systems with total capacity up to 11.08 kW	≤11.08 kW	N/A
B.1.2.2.2	Reactive power capability - Inverter in systems with total capacity greater than 11.08 kW	>11.08 kW	P
B.1.2.3	Reactive power supply at a given level (greater 11.08 kW systems, but can requested for smaller systems as well)	>11.08 kW *	P
B.1.2.4	Response time to an assigned step level change (greater 11.08 kW systems)	>11.08 kW *	P
B.1.2.5	Automatic supply of reactive power according to the characteristic curve $\cos \varphi = f(P)$		P
B.1.2.6	Automatic supply of reactive power according to the characteristic curve $Q = f(V)$ (greater 11.08kW systems)	>11.08 kW *	P
B.1.3.1	Automatic limitation of active power for voltage values close to 110% of the rated voltage		P
B.1.3.2	Adjustment of active power in the presence of over-frequency transients on the transmission network		P
B.1.3.3	Verification of the operating range in voltage and frequency		P
B.1.3.3.1	Reduction of active power in the presence of transient under-frequency on transmission network		P
B.1.3.4	Limitation of active power by external control from the distributor		P
B.1.4.1	Checking the DC component output current		P
B.1.4.2	Checking the protection against DC input		P
B.1.5	Checking insensitivity of voltage dips (LVRT and OVRT(8.5. 1-figure 30) capability) [greater 11.08 kW systems]	>11.08 kW	P
B.1.6	Checking the insensitivity to automatic reclosing during phase discordance		P

Clause	Test Item	Remark	P / F / N/A
Hybrid inverter use battery for testing:			
Bbis.3 a)/b)	Harmonics measurement		P
Bbis.3 c)	Flicker measurement		P
Bbis.4	Check the operating range in voltage and frequency		P
Bbis.5	Conditions of connection, reconnection and gradual power supply		P
Bbis.6.1 & Bbis.6.2	Checking construction requirements: reactive power capability		P
Bbis.6.3 & Bbis.6.4	Reactive power production according to an assigned level	>11.08 kW *	P
Bbis.6.5	Response time to a step change of the assigned level	>11.08 kW *	P
Bbis.6.6 & Bbis.6.7	Automatic production of reactive power according to a characteristic curve $\cos \varphi = f(P)$		P
Bbis.6.8 & Bbis.6.9	Automatic reactive power production according to a characteristic curve $Q = f(V)$	>11.08 kW *	P
Bbis.7.1	Active power limitation for voltage values near to 110 % U_n		P
Bbis.7.2	Verification of automatic reduction of active power in the presence of overfrequency transients on the network		P
Bbis.7.3	Verification of the automatic increase of active power in the presence of underfrequency transients on the network		P
Bbis.7.4	Active power limitation in coincidence with external command coming from the Electricity Distributor		P
Bbis.7.4.1	Verification of the settling time at a power increase / decrease command		P
Bbis.8.1	Verification of continuous component emission		P
Bbis.8.2	Verification of protections against the continuous DC injection		P
Bbis.9	Verification of insensitivity to voltage dips (UVRT and OVRT(8.5.1-figure 30 capability)	>11.08 kW	P
Bbis.10	Verification of insensitivity to automatic reclosing in phase discrepancy		P
<p>Remark: * The tests described in this paragraph are mandatory only for inverters used in plants with a power greater than 11.08 kW, but at the request of the manufacturer they can also be carried out and documented for smaller size converters.</p>			

CEI 0-21								
Clause	Requirement - Test				Result - Remark			Verdict
A.3	TABLE: Adjustment ranges for the SPI							P
Voltage values								
Threshold	85% U_n (27.S1)	t_{min} (27.S1)	15% U_n (27.S2)	t_{min} (27.S2)	110% U_n (59.S1)	t_{max} (59.S1)	115% U_n (59.S2)	t_{max} (59.S2)
Range	0.2-1.0 U_n	0.05-5 s	0.05-1.0 U_n	0.05-5 s	1.0-1.2 U_n	0.2-10 s	1.0-1.3 U_n	0.05-1.0 s
Steps	0.05 U_n	0.05 s	0.05 U_n	0.05 s	0.01 U_n	0.1 s	0.01 U_n	0.05 s
Frequency values								
Threshold	49.50 Hz (81<.S1)	t_{min} (81<.S1)	47.50 Hz (81<.S2)	t_{min} (81<.S2)	50.50 Hz (81>.S1)	t_{max} (81>.S1)	51.50 Hz (81>.S2)	t_{max} (81>.S2)
Range	47.0-50.0 Hz	0.05-5s	47.0-50.0 Hz	0.05-5s	50.0-52.0 Hz	0.05-5 s	50.0-52.0 Hz	0.05-5 s
Steps	0.1 Hz	0.05 s	0.1 Hz	0.05 s	0.1 Hz	0.05 s	0.1 Hz	0.05 s
Table 13 - SPI adjustments (with the exception of systems with power less than 800 W)								
Protection		Intervention threshold	Intervention time (time elapsing between the instant the anomalous condition detected by the protection starts and the release of the trip command)					
Maximum voltage (59.S1, 10 min moving average measurement, in accordance with CEI EN 61000-4-30)		1,10 V_n	Variable according to the initial and final voltage value, maximum 603 s.					
Maximum voltage (59.S2)		1,15 V_n	0,2 s					
Minimum voltage (27.S1)		0,85 V_n	1,5 s					
Minimum voltage (27.S2) *		0,15 V_n	0,2 s					
Maximum frequency (81>.S1)** \diamond		50,2 Hz	0,1 s					
Minimum frequency (81<.S1)** \diamond		49,8 Hz	0,1 s					
Maximum frequency (81>.S2) \diamond		51,5 Hz	0,1 s or 1 s §					
Minimum frequency (81<.S2) \diamond		47,5 Hz	0,1 s or 4 s §					
<p>* The value indicated for the intervention time must be adopted when the total power is higher than 11.08 kW, while for lower powers, an intervention time without intentional delay can be optionally used. In the case of synchronous generators, the value can be raised to 0.7 V_n and $t = 0.150$ s</p> <p>** Threshold enabled only with external signal at high value and with high local command.</p> <p>\diamond For voltage values below 0.2 V_n, the maximum / minimum frequency protection must be inhibited.</p> <p>§ In this regard, see what is reported in the text that follows Figure 35.</p>								

CEI 0-21			
Clause	Requirement - Test	Result - Remark	Verdict

A.4.3.1 & A.4.3.2	TABLE: Test procedure for maximum/minimum frequency (81.S2) (stand alone, use of the SPI on the basis of local information only)					P
Model	VT-6607106					
	Under frequency:			Over frequency:		
A) STEPS for trip value [Hz to Hz]:	1.01 threshold -> decrease by max 10mHz steps			0.99 threshold -> increase by max 10mHz steps		
D) STEP trip time [Hz to Hz]:	1.01 threshold -> 0.99 threshold			0.99 threshold -> 1.01 threshold		
Ambient temperature						
Limit [Hz]:	47.50 Hz (81<.S2)			51.50 Hz (81>.S2)		
Measurement accuracy of the tripping value [Hz]:	47.51	47.50	47.51	51.50	51.49	51.51
Trip time limit [ms]:	100 ms			100 ms		
Measurement the trip time [ms]:	96.0	85.0	86.0	99.0	97.0	97.0
-20°C temperature						
Limit [Hz]:	47.50 Hz (81<.S2)			51.50 Hz (81>.S2)		
Measurement accuracy of the tripping value [Hz]:	47.50	47.50	47.51	51.51	51.50	51.50
Trip time limit [ms]:	100 ms			100 ms		
Measurement the trip time [ms]:	95.0	96.4	98.8	91.0	92.0	93.0
+60°C temperature						
Limit [ms]:	47.50 Hz (81<.S2)			51.50 Hz (81>.S2)		
Measurement accuracy of the tripping value [Hz]:	47.50	47.49	47.50	51.49	51.50	51.49
Trip time limit [ms]:	100 ms			100 ms		
Measurement the trip time [ms]:	98.0	98.8	96.8	97.0	100.0	91.0
Assessment criterion:						
For frequencies of between 47,5 Hz and 51,5 Hz ($\pm 0,1\%$ fn) automatic disconnection from the network as a result of a deviation in frequency is not permitted.						
Limit values:						
Frequency decrease protection $f < 47,5$ Hz 100 ms						
Frequency increase protection $f < 51,5$ Hz 100 ms						
Verification is pass when the SPI trip occurs within the following limits for at least 3 consecutive tests:						
- $\leq 1\%$ Vn for voltage intervention thresholds						
- ± 20 mHz for frequency intervention thresholds						
- $\leq 3\%$ ± 20 ms for intervention times						
- $\leq 1\%$ Vn for voltage recovery thresholds						
- ± 20 mHz for frequency recovery thresholds						
For each repetition of the tests, the max tolerances of the values are:						
Voltage: 2%						
Frequency: ± 20 mHz						
Trip times: $1\% \pm 20$ ms						
Note:						
*If the EUT operating temperature out of -10°C to 55°C, please use the upper and lower operating temperature limit in the test.						

CEI 0-21			
Clause	Requirement - Test	Result - Remark	Verdict

A.4.3.1 & A.4.3.2	TABLE: Test procedure for maximum/minimum frequency (81.S2) (use of SPI on the basis of local readings and external information/commands)					P
Model	VT-6607106					
	Under frequency:			Over frequency:		
A) STEPS for trip value [Hz to Hz]:	1.01 threshold -> decrease by max 10mHz steps			0.99 threshold -> increase by max 10mHz steps		
D) STEP trip time [Hz to Hz]:	1.01 threshold -> 0.99 threshold			0.99 threshold -> 1.01 threshold		
Ambient temperature						
Limit [Hz]:	47.50 Hz (81<.S2)			51.50 Hz (81>.S2)		
Measurement accuracy of the tripping value [Hz]:	47.49	47.51	47.51	51.51	51.50	51.51
Trip time limit [ms]:	4000 ms			1000 ms		
Measurement the trip time [ms]:	3978	3990	3970	991	998	994
-20°C temperature						
Limit [Hz]:	47.50 Hz (81<.S2)			51.50 Hz (81>.S2)		
Measurement accuracy of the tripping value [Hz]:	47.50	47.50	47.51	51.50	51.50	51.51
Trip time limit [ms]:	4000 ms			1000 ms		
Measurement the trip time [ms]:	3980	3990	3990	994	990	994
+60°C temperature						
Limit [ms]:	47.50 Hz (81<.S2)			51.50 Hz (81>.S2)		
Measurement accuracy of the tripping value [Hz]:	47.50	47.51	47.51	51.51	51.51	51.50
Trip time limit [ms]:	4000 ms			1000 ms		
Measurement the trip time [ms]:	3990	3980	3990	990	998	998
Assessment criterion:						
For frequencies of between 47,5 Hz and 51,5 Hz ($\pm 0,1\%$ fn) automatic disconnection from the network as a result of a deviation in frequency is not permitted.						
Limit values:						
Frequency decrease protection $f < 47,5$ Hz 4000 ms						
Frequency increase protection $f < 51,5$ Hz 1000 ms						
Verification is pass when the SPI trip occurs within the following limits for at least 3 consecutive tests:						
- $\leq 1\%$ Vn for voltage intervention thresholds						
- ± 20 mHz for frequency intervention thresholds						
- $\leq 3\%$ ± 20 ms for intervention times						
- $\leq 1\%$ Vn for voltage recovery thresholds						
- ± 20 mHz for frequency recovery thresholds						
For each repetition of the tests, the max tolerances of the values are:						
Voltage: 2%						
Frequency: ± 20 mHz						
Trip times: $1\% \pm 20$ ms						
Note:						
*If the EUT operating temperature out of -10°C to 55°C, please use the upper and lower operating temperature limit in the test.						

CEI 0-21			
Clause	Requirement - Test	Result - Remark	Verdict

A.4.3.1 & A4.3.2	TABLE: Test procedure for maximum/minimum frequency functions (81.S1)					P
Model	VT-6607106					
	Under frequency:			Over frequency:		
A) STEPS for trip value [Hz to Hz]:	1.01 threshold -> decrease by max 10mHz steps			0.99 threshold -> increase by max 10mHz steps		
D) STEP trip time [Hz to Hz]:	1.01 threshold -> 0.99 threshold			0.99 threshold -> 1.01 threshold		
Ambient temperature						
Tripping threshold limit [Hz]:	49.80 (81<.S1)			50.20 (81>.S1)		
Measurement accuracy of the tripping value [Hz]:	49.82	49.81	49.80	50.20	50.21	50.21
Trip time limit [ms]:	100			100		
Measurement the trip time [ms]:	98.0	96.0	92.0	94.0	97.0	92.0
-20°C temperature						
Tripping threshold limit [Hz]:	49.80 (81<.S1)			50.20 (81>.S1)		
Measurement accuracy of the tripping value [Hz]:	49.81	49.80	49.79	50.21	50.21	50.20
Trip time limit [ms]:	100			100		
Measurement the trip time [ms]:	94.8	95.8	95.0	94.0	88.0	88.0
+60°C temperature						
Tripping threshold limit [Hz]:	49.80 (81<.S1)			50.20 (81>.S1)		
Measurement accuracy of the tripping value [Hz]:	49.81	49.79	49.81	50.21	50.20	50.21
Trip time limit [ms]:	100			100		
Measurement the trip time [ms]:	90.4	92.8	94.8	99.0	98.0	100.0
Note: Threshold enabled only with external signal at high value and with high local command.						
Assessment criterion:						
For frequencies of between 49,8 Hz and 50,2 Hz automatic disconnection from the network as a result of a deviation in frequency is not permitted.						
Limit values:						
Frequency decrease protection < 49,8 Hz 100 ms						
Frequency increase protection < 50,2 Hz 100 ms						
Verification is pass when the SPI trip occurs within the following limits for at least 3 consecutive tests:						
- ≤ 1% Vn for voltage intervention thresholds						
- ±20 mHz for frequency intervention thresholds						
- ≤ 3 % ± 20 ms for intervention times						
- ≤ 1 % Vn for voltage recovery thresholds						
- ±20 mHz for frequency recovery thresholds						
For each repetition of the tests, the max tolerances of the values are:						
Voltage: 2%						
Frequency: ±20mHz						
Trip times: 1%±20ms						
Note:						
*If the EUT operating temperature out of -10°C to 55°C, please use the upper and lower operating temperature limit in the test (such as -25°C / +60°C).						

CEI 0-21			
Clause	Requirement - Test	Result - Remark	Verdict

A.4.3.1 & A.4.3.2	TABLE: Test procedure for maximum/minimum voltage (27.S1)			P
Model:	VT-6607106			
	Under voltage:			
A) STEPS for trip value [V to V]:	1.1 threshold -> decrease by 0.5% Vn steps			
D) STEP for trip time [V to V]:	1.1 threshold -> 0.9 threshold			
Ambient temperature				
Limit [V]:	195.5 V (27.S1)			
Measurement accuracy of the tripping value [V]:	195.54	195.42	195.36	
Trip time limit [ms]:	1500 ms			
Measurement the trip time [ms]:	1490	1480	1490	
-20°C temperature				
Limit [V]:	195.5 V (27.S1)			
Measurement accuracy of the tripping value [V]:	195.38	195.71	196.01	
Trip time limit [ms]:	1500 ms			
Measurement the trip time [ms]:	1498	1490	1490	
+60°C temperature				
Limit [V]:	195.5 V (27.S1)			
Measurement accuracy of the tripping value [V]:	195.69	195.82	195.55	
Trip time limit [ms]:	1500 ms			
Measurement the trip time [ms]:	1490	1498	1480	
Note:				
Verification is pass when the SPI trip occurs within the following limits for at least 3 consecutive tests:				
- ≤ 1% Vn for voltage intervention thresholds				
- ±20 mHz for frequency intervention thresholds				
- ≤ 3 % ± 20 ms for intervention times				
- ≤ 1 % Vn for voltage recovery thresholds				
- ±20 mHz for frequency recovery thresholds				
For each repetition of the tests, the max tolerances of the values are:				
Voltage: 2%				
Frequency: ±20mHz				
Trip times: 1%±20ms				
*If the EUT operating temperature out of -10°C to 55°C, please use the upper and lower operating temperature limit in the test (such as -25°C / +60°C).				

CEI 0-21			
Clause	Requirement - Test	Result - Remark	Verdict

A.4.3.1 & A.4.3.2	TABLE: Test procedure for maximum/minimum voltage (27.S2) (59.S2)					P
Model	VT-6607106					
	Under voltage:			Over voltage:		
A) STEPS for trip value [V to V]:	1.1 threshold -> decrease by 0.5% Vn steps			0.9 threshold -> increase by 0.5% Vn steps		
D) STEP for trip time [V to V]:	1.1 threshold -> 0.9 threshold			0.9 threshold -> 1.08 threshold		
Ambient temperature						
Limit [V]:	34.5 V (27.S2)			264.5 V (59.S2)		
Measurement accuracy of the tripping value [V]:	34.51	34.53	34.51	264.52	264.58	265.12
Trip time limit [ms]:	200 ms			200 ms		
Measurement the trip time [ms]:	198.0	196.0	198.8	190.0	198.0	188.0
-20°C temperature						
Limit [V]:	34.5 V (27.S2)			264.5 V (59.S2)		
Measurement accuracy of the tripping value [V]:	34.49	34.50	34.51	264.58	264.51	264.56
Trip time limit [ms]:	200 ms			200 ms		
Measurement the trip time [ms]:	196.8	188.0	196.0	196.0	190.0	190.0
+60°C temperature						
Limit [V]:	34.5 V (27.S2)			264.5 V (59.S2)		
Measurement accuracy of the tripping value [V]:	34.48	34.52	34.51	264.59	264.55	264.59
Trip time limit [ms]:	200 ms			200 ms		
Measurement the trip time [ms]:	194.4	188.8	199.6	189.0	192.0	191.0
Note:						
Verification is pass when the SPI trip occurs within the following limits for at least 3 consecutive tests:						
- ≤ 1% Vn for voltage intervention thresholds						
- ±20 mHz for frequency intervention thresholds						
- ≤ 3 % ± 20 ms for intervention times						
- ≤ 1 % Vn for voltage recovery thresholds						
- ±20 mHz for frequency recovery thresholds						
For each repetition of the tests, the max tolerances of the values are:						
Voltage: 2%						
Frequency: ±20mHz						
Trip times: 1%±20ms						
*If the EUT operating temperature out of -10°C to 55°C, please use the upper and lower operating temperature limit in the test (such as -25°C / +60°C).						

CEI 0-21			
Clause	Requirement - Test	Result - Remark	Verdict

A.4.3.1 & A.4.3.2	TABLE: Measuring the rise-in voltage protection as a running 10-minute mean value (59.S1)		P
Model:	VT-6607106		
Test:	Disconnection time:	Limit:	
a)	The voltage is set to 100% U_n and held for 600 s. Thereafter the voltage is set to 112% U_n (257.6 V). Disconnection must take place within 603 s.		
	Phase 1	489	≤ 603 s
	Phase 2	-	
	Phase 3	-	
b)	The voltage is set to U_n for 600 s and then to 108% U_n (248.4 V) for 600 s. No disconnection should take place.		
	Phase 1	No disconnection	Disconnection should not take place.
	Phase 2	-	
	Phase 3	-	
c)	The voltage is set to 106 % U_n (243.8 V) and held for 600 s. Thereafter the voltage is set to 114 % U_n (262.6 V). Disconnection must take place within 300 s or about 50 % of the disconnection time measured in point a).*		
	Phase 1	292	The disconnection time should be about 50 % of the value measured in a). *
	Phase 2	-	
	Phase 3	-	

Note:

*If the setting value is set to 600 s, then the disconnection time can be in the range between 225 s and 375 s.

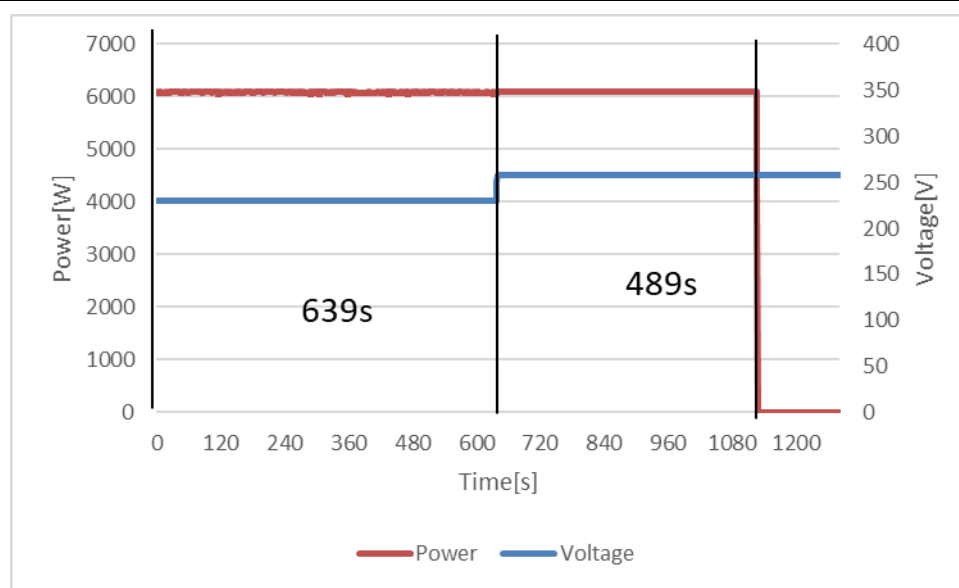

a)

CEI 0-21			
Clause	Requirement - Test	Result - Remark	Verdict

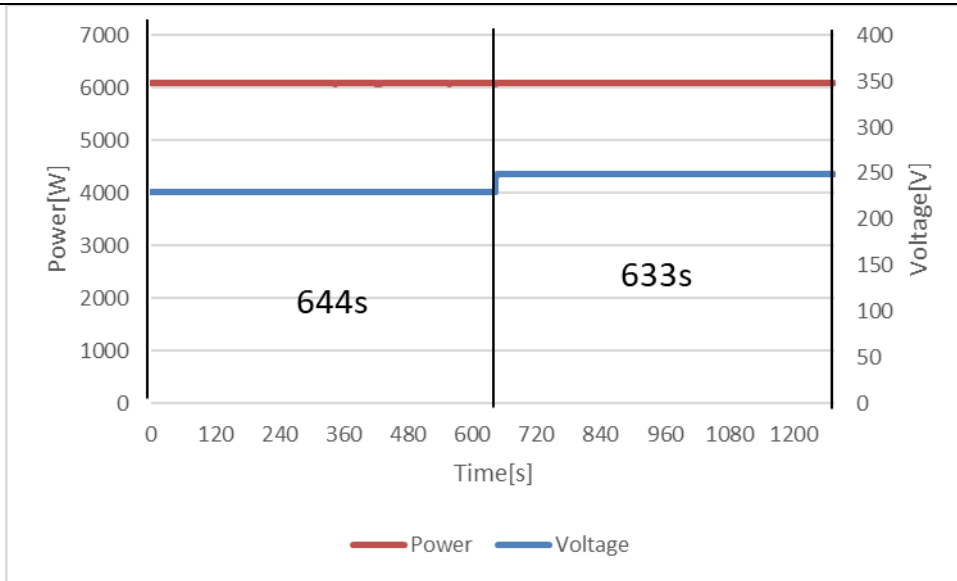

b)

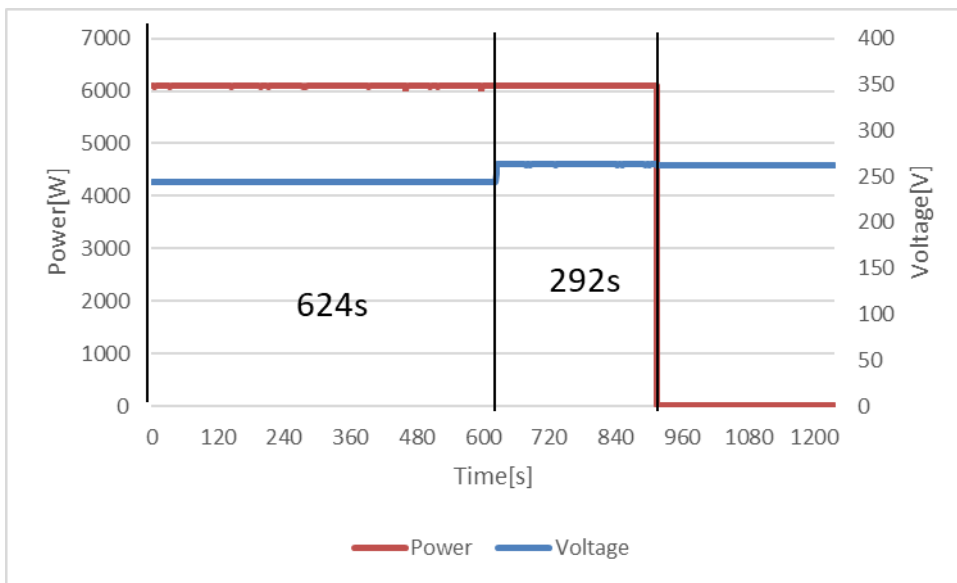

c)

CEI 0-21			
Clause	Requirement - Test	Result - Remark	Verdict

A.4.3.3.1	TABLE: Insensitivity to harmonics of the frequency relay	P
------------------	---	----------

Mode	VT-6607106								
------	------------	--	--	--	--	--	--	--	--

Grid simulator settings according to Table 17:	Harmonics order:	2nd	3rd	5th	7th	9th	11th	13th	17th
	%Un:	4.0	10,0	12,0	10,0	3,0	7,0	6,0	4,0

Operating time of the monitoring device:

	Under frequency:			Over frequency:		
A) STEPS for trip value [Hz to Hz]:	1.01 threshold -> decrease by max 10mHz steps			0.99 threshold -> increase by max 10mHz steps		
D) STEP trip time [Hz to Hz]:	1.01 threshold -> 0.99 threshold			0.99 threshold -> 1.01 threshold		
Limit [Hz]:	47.50 Hz			51.50 Hz		
Measurement accuracy of the tripping value [V]:	47.49	47.49	47.48	51.51	51.52	51.51
	100 ms			100 ms		
Measurement the trip time [ms]:	97.7	96.8	97.2	96.8	97.6	96.0

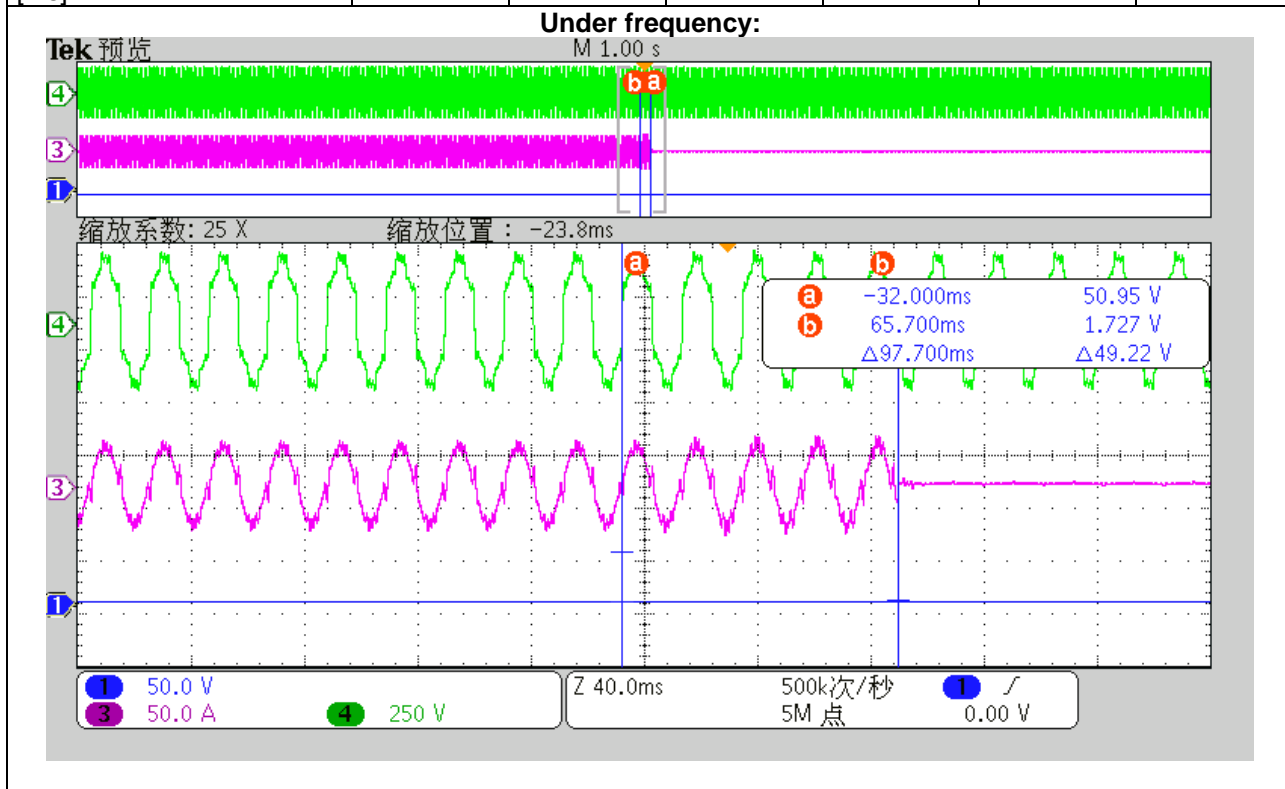

CEI 0-21			
Clause	Requirement - Test	Result - Remark	Verdict

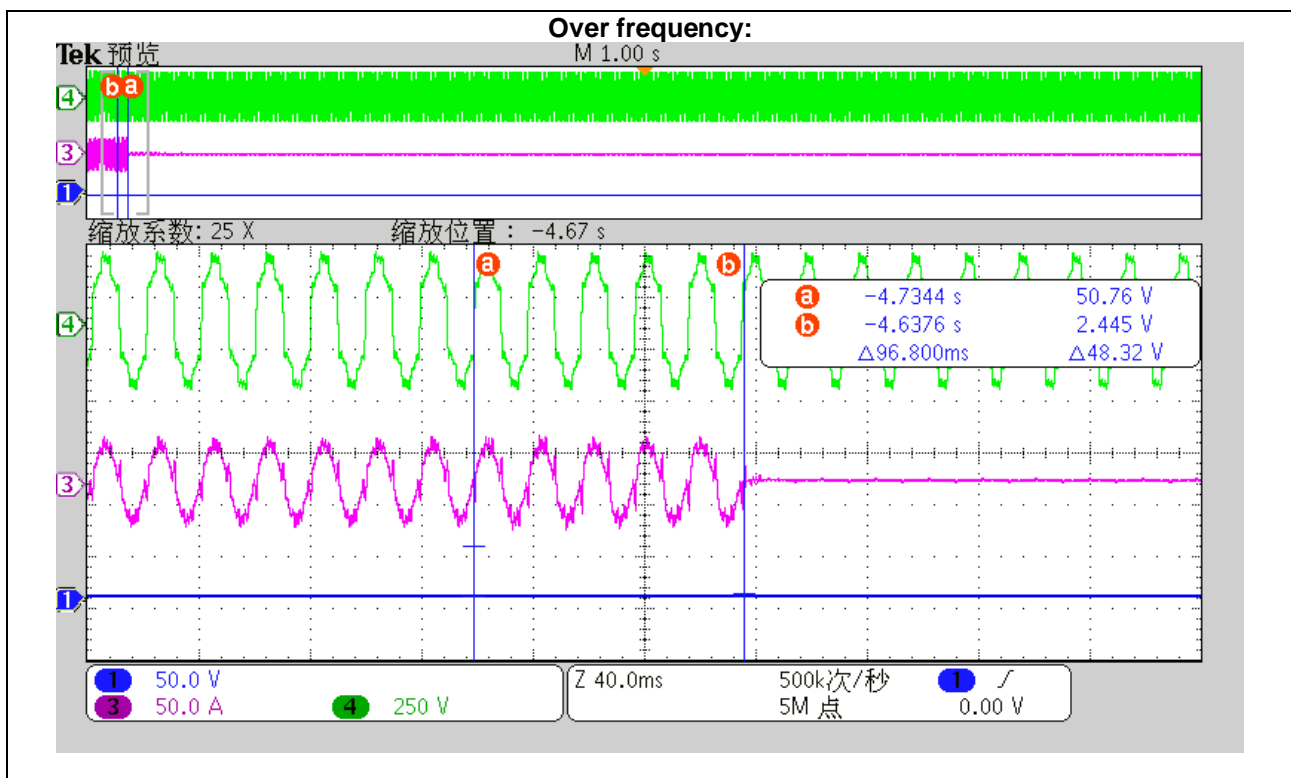

Note:

The setting value and the trip value of the frequency may not vary by more than $\pm 20\text{mHz}$ and $3\% \pm 20\text{ms}$. Differences between the test values: $\pm 20\text{mHz}$ and $1\% \pm 20\text{ms}$.

Screenshot of voltage waveform, distorted as required by CEI 0-21 Table 17 – Harmonics for the insensitivity of the frequency protection function.



CEI 0-21			
Clause	Requirement - Test	Result - Remark	Verdict

A.4.3.3.2	TABLE: Remote trip signal	P
Model	VT-6607106	
Test:	Remote tripping signal for the external disconnection	
Limit [ms]:	50	
Measurement time of the tripping value [ms]:	42.8	

Graph of remote trip signal:

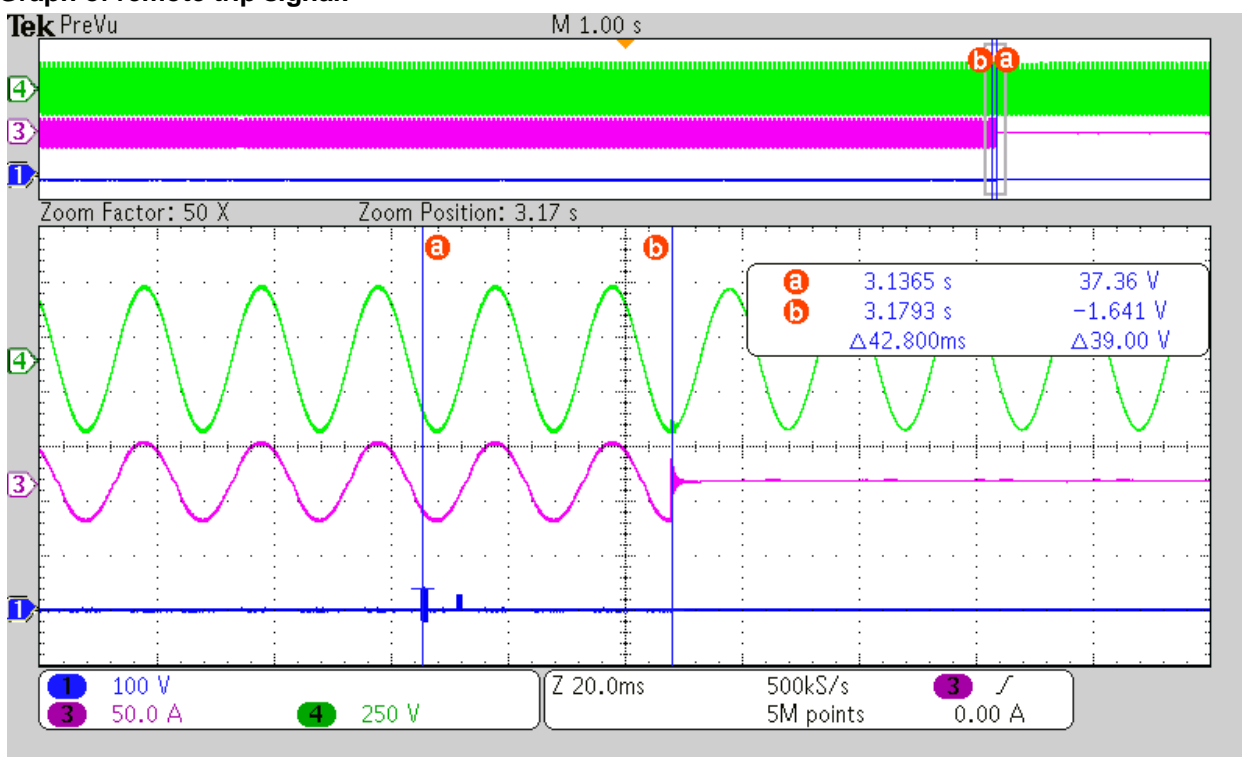

Note:

The protection interface has to have a maximum delay of the remote tripping signal from receiving to transmitting to the DDI of 50ms.

CEI 0-21			
Clause	Requirement - Test	Result - Remark	Verdict

A.4.3.3.3	TABLE: Communication Signal	P	
Model	VT-6607106		
Enlargement of the frequency limits:		Yes	No
Enabled the trip of the functions 81<.S1 (49.8Hz) and 81>.S1 (50.2Hz) without communication signal		<input checked="" type="checkbox"/>	<input type="checkbox"/>
Enabled the trip of the functions 81<.S2 (47.5Hz) and 81>.S2 (51.5Hz) with communication signal		<input checked="" type="checkbox"/>	<input type="checkbox"/>

Note:

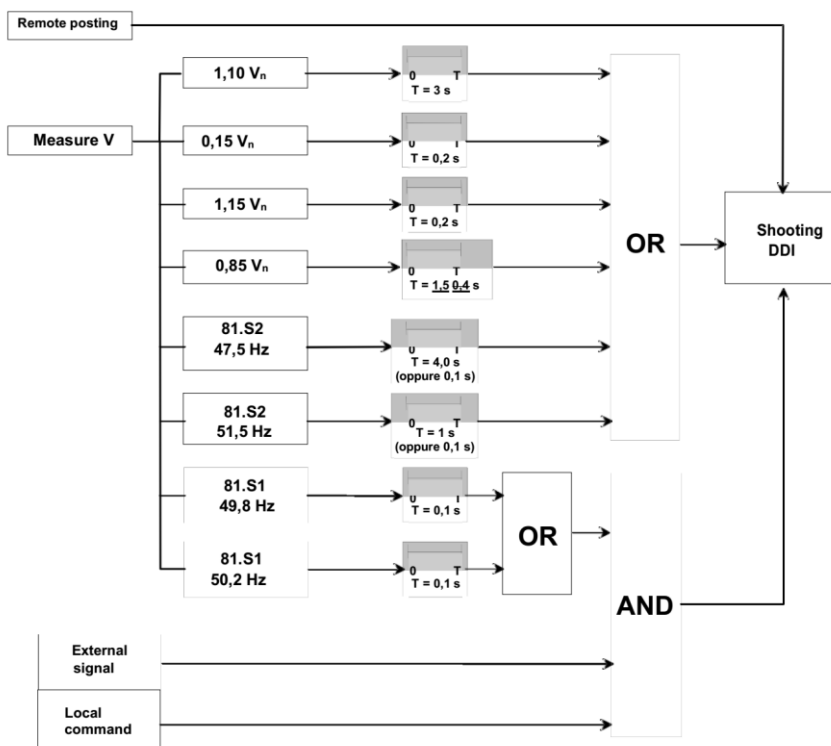
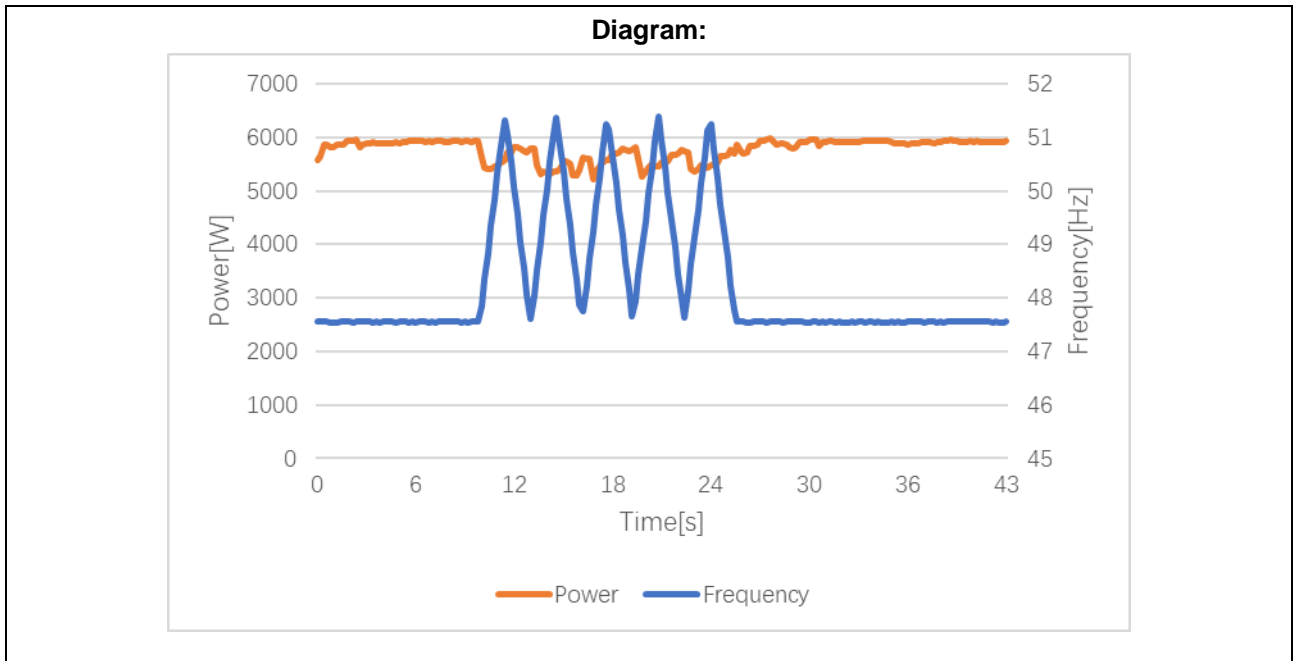

Figure 35 - Functional logic diagram of the SPI of the power park modules (the values in brackets refer to the transitory operating mode of the SPI)

CEI 0-21			
Clause	Requirement - Test	Result - Remark	Verdict

A.4.3.4	TABLE: Verification of insensitivity to the frequency derivative (ROCOF)						P
Model	VT-6607106						
Setting threshold (81 >)		Setting trip time		Setting threshold (81 <)		Setting trip time	
51.5 Hz		0.15 s		47.5 Hz		0.15 s	
Step	Frequency		Change time	Output power (W)	Result (Continuous operation or not)	Requirement	
	Begin	End					
1)	47.55 Hz	47.55 Hz	10.0 s	5890.42	Continuous operation	Stay connected	
2)	47.55 Hz	51.45 Hz	1.56 s	5531.60	Continuous operation	Stay connected	
3)	51.45 Hz	47.55 Hz	1.56 s	5782.43	Continuous operation	Stay connected	
2)	47.55 Hz	51.45 Hz	1.56 s	5358.43	Continuous operation	Stay connected	
3)	51.45 Hz	47.55 Hz	1.56 s	5444.25	Continuous operation	Stay connected	
2)	47.55 Hz	51.45 Hz	1.56 s	5490.13	Continuous operation	Stay connected	
3)	51.45 Hz	47.55 Hz	1.56 s	5746.13	Continuous operation	Stay connected	
2)	47.55 Hz	51.45 Hz	1.56 s	5437.57	Continuous operation	Stay connected	
3)	51.45 Hz	47.55 Hz	1.56 s	5644.50	Continuous operation	Stay connected	
2)	47.55 Hz	51.45 Hz	1.56 s	5466.25	Continuous operation	Stay connected	
3)	51.45 Hz	47.55 Hz	1.56 s	5636.43	Continuous operation	Stay connected	
5)	47.55 Hz	47.55 Hz	10.0 s	5901.80	Continuous operation	Stay connected	
Test procedure:							
<ol style="list-style-type: none"> Apply a three-phase of symmetrical voltages of direct cyclic sequence having an amplitude of 100% of the rated voltage and a frequency of 47.550 Hz; increase the frequency of the three-phase voltages, with ramp steps having an amplitude of 12.5 mHz and duration of 5 ms, until reaching the frequency value of 51.450 Hz; decrease the frequency of the three-phase voltages, with ramp steps having an amplitude equal to 12.5 mHz and duration 5 ms until reaching the frequency value of 47.550 Hz; repeat the tests referred to in points 2 and 3 above four times, for a total of 5 positive and negative ramps. Apply a three-phase of symmetrical voltages of direct cyclic sequence having an amplitude of 100% of the rated voltage and a frequency of 47.550 Hz for 10 s. 							
Note:							
When considering a sliding measurement window of 1.56 s, these profiles have a maximum RoCoF of 2.5 Hz/s.							

CEI 0-21			
Clause	Requirement - Test	Result - Remark	Verdict



CEI 0-21			
Clause	Requirement - Test	Result - Remark	Verdict

A.4.4	TABLE: Self-test			P
Model	VT-6607106			
Software version: Control board: V06, Display board: V06				
Can the self-test be activated from any user? (<input checked="" type="checkbox"/> YES; <input type="checkbox"/> NO)				
Do the procedures be written / described in the user manual? (<input checked="" type="checkbox"/> YES; <input type="checkbox"/> NO)				
Can the self-test results and the preset values be clearly readable / displayed? (<input checked="" type="checkbox"/> YES; <input type="checkbox"/> NO)				
Accuracy		Threshold	Disconnection time	Tolerance
Overvoltage 59.S1	Reading	253.0V	601000ms	Is the voltage thresholds deviation within 1%? <input checked="" type="checkbox"/> YES, <input type="checkbox"/> NO) Is the time deviation within 3% ± 20 ms? <input checked="" type="checkbox"/> YES, <input type="checkbox"/> NO) Is the frequency thresholds deviation within ± 20 mHz? <input checked="" type="checkbox"/> YES, <input type="checkbox"/> NO) Is the time deviation within 3% ± 20 ms? <input checked="" type="checkbox"/> YES, <input type="checkbox"/> NO)
	Default	253.0 V	<603000 ms	
Overvoltage 59.S2	Reading	264.6V	198ms	
	Default	264.5 V	200 ms	
Undervoltage 27.S1	Reading	195.4V	1490ms	
	Default	195.5 V	1500 ms	
Undervoltage 27.S2	Reading	34.4V	196ms	
	Default	34.5 V	200 ms	
Overfrequency 81>.S1	Reading	50.2 Hz	95 ms	
	Default	50.2 Hz	100 ms	
Overfrequency 81>.S2	Reading	51.5 Hz	98 ms	
	Default	51.5 Hz	100 ms	
Underfrequency 81<.S2	Reading	49.8 Hz	99 ms	
	Default	49.8 Hz	100 ms	
Underfrequency 81<.S2	Reading	47.5 Hz	97 ms	
	Default	47.5 Hz	100 ms	
Note: In the event that the interface protection functions are integrated into the inverter, at least one self-test system must be provided to check the maximum / minimum frequency and maximum / minimum voltage functions provided for in the SPI as described below: <ul style="list-style-type: none"> - for each frequency and voltage protection function, the rise or fall intervention threshold shall be linearly varied with a ramp $\leq 0,05$ Hz/s or $\leq 0,05$ Vn/s for frequency and voltage protection respectively; - this determines, at a certain point of the test, the coincidence between the threshold and the current value of the controlled magnitude (frequency or voltage) and therefore the intervention of the protection and the consequent opening of the interface device. For each test the values of the quantities and the intervention times shall be viewable by the tester as well as the current value of the voltage and frequency detected by the converter.				

CEI 0-21			
Clause	Requirement - Test	Result - Remark	Verdict

Diagram of auto-test:													
Overvoltage 59.S1													
<table border="1"> <thead> <tr> <th colspan="2">Autotest 59.S1</th> </tr> </thead> <tbody> <tr> <td>Vac 10m Max</td> <td>253.0V</td> </tr> <tr> <td>Vac 10m</td> <td>253.0V</td> </tr> <tr> <td>Vac Disat</td> <td>253.0V</td> </tr> <tr> <td>T Disat</td> <td>601000ms</td> </tr> </tbody> </table>				Autotest 59.S1		Vac 10m Max	253.0V	Vac 10m	253.0V	Vac Disat	253.0V	T Disat	601000ms
Autotest 59.S1													
Vac 10m Max	253.0V												
Vac 10m	253.0V												
Vac Disat	253.0V												
T Disat	601000ms												
Overvoltage 59.S2													
<table border="1"> <thead> <tr> <th colspan="2">Autotest 59.S2</th> </tr> </thead> <tbody> <tr> <td>Vac Max</td> <td>264.5V</td> </tr> <tr> <td>Vac</td> <td>264.5V</td> </tr> <tr> <td>Vac Disat</td> <td>264.6V</td> </tr> <tr> <td>T Disat</td> <td>198ms</td> </tr> </tbody> </table>				Autotest 59.S2		Vac Max	264.5V	Vac	264.5V	Vac Disat	264.6V	T Disat	198ms
Autotest 59.S2													
Vac Max	264.5V												
Vac	264.5V												
Vac Disat	264.6V												
T Disat	198ms												
Undervoltage 27.S1													
<table border="1"> <thead> <tr> <th colspan="2">Autotest 27.S1</th> </tr> </thead> <tbody> <tr> <td>Vac min</td> <td>195.5V</td> </tr> <tr> <td>Vac</td> <td>195.5V</td> </tr> <tr> <td>Vac Disat</td> <td>195.4V</td> </tr> <tr> <td>T Disat</td> <td>1490ms</td> </tr> </tbody> </table>				Autotest 27.S1		Vac min	195.5V	Vac	195.5V	Vac Disat	195.4V	T Disat	1490ms
Autotest 27.S1													
Vac min	195.5V												
Vac	195.5V												
Vac Disat	195.4V												
T Disat	1490ms												
Undervoltage 27.S2													
<table border="1"> <thead> <tr> <th colspan="2">Autotest 27.S2</th> </tr> </thead> <tbody> <tr> <td>Vac min</td> <td>34.5V</td> </tr> <tr> <td>Vac</td> <td>34.5V</td> </tr> <tr> <td>Vac Disat</td> <td>34.4V</td> </tr> <tr> <td>T Disat</td> <td>196ms</td> </tr> </tbody> </table>				Autotest 27.S2		Vac min	34.5V	Vac	34.5V	Vac Disat	34.4V	T Disat	196ms
Autotest 27.S2													
Vac min	34.5V												
Vac	34.5V												
Vac Disat	34.4V												
T Disat	196ms												

CEI 0-21			
Clause	Requirement - Test	Result - Remark	Verdict
Overfrequency 81>S1			
Autotest 81>.S1			
F max 50.20Hz			
Freq 50.20Hz			
F Disat 50.20Hz			
T Disat 95ms			
Overfrequency 81>S2			
Autotest 81>.S2			
F max 51.50Hz			
Freq 51.50Hz			
F Disat 51.50Hz			
T Disat 98ms			
Underfrequency 81<S1			
Autotest 81<.S1			
F min 49.80Hz			
Freq 49.80Hz			
F Disat 49.80Hz			
T Disat 99ms			
Underfrequency 81<S2			
Autotest 81<.S2			
F min 47.50Hz			
Freq 47.50Hz			
F Disat 47.50Hz			
T Disat 97ms			

CEI 0-21			
Clause	Requirement - Test	Result - Remark	Verdict

A.4.5		TABLE: Single fault tolerance				P
Model		VT-6607106				
Ambient temperature (°C)					25°C	
No.	component No.	fault	test voltage (V)	test time	result	
1	ISO Relay (ALFG1)	Short circuit before start up inverter	360Vdc-230Vac	3min	Unit can't operating, error message: Iso Fault. No danger, no hazard, no fire.	
2	Monitoring Relay – L (K1)	Pin3 to Pin4 short circuit before start up inverter	360Vdc-230Vac	3min	Unit can't operating, error message:GridRelay Fault. No danger, no hazard, no fire.	
3	Monitoring Relay – L (K1)	Pin3 to Pin4 open circuit before start up inverter	360Vdc-230Vac	3min	Unit can't operating, error message: GridRelay Fault. No danger, no hazard, no fire.	
4	Monitoring Relay - N(K3)	Pin3 to Pin4 short circuit before start up inverter	360Vdc-230Vac	3min	Unit can't operating, error message: GridRelay Fault. No danger, no hazard, no fire.	
5	Monitoring Relay - N(K3)	Pin3 to Pin4 open circuit before start up inverter	360Vdc-230Vac	3min	Unit can't operating, error message: GridRelay Fault. No danger, no hazard, no fire.	
6	AC voltage measure1 (D4)	Pin2-Pin3	360Vdc-230Vac	3min	Unit shut down, Error message: GridOverVolt Fault. No danger, no hazard, no fire.	
7	AC voltage measure1(D4)	Pin1-Pin3 Short circuit	360Vdc-230Vac	3min	Unit shut down, Error message: GridOverVolt Fault. No danger, no hazard, no fire.	
8	AC current measure1(D19)	Pin1-Pin3 Short circuit	360Vdc-230Vac	3min	Unit can't operating, error message: RInvCurAdChaFault. No danger, no hazard, no fire.	
9	AC current measure1(D19)	Pin2-Pin3 Short circuit	360Vdc-230Vac	3min	Unit can't operating, error message: RInvCurAdChaFault. No danger, no hazard, no fire.	
10	AC current measure2(D20)	Pin1-Pin3 Short circuit	360Vdc-230Vac	3min	Unit can't operating, error message: SInvCurAdChaFault. No danger, no hazard, no fire.	
11	AC current measure2(D20)	Pin2-Pin3 Short circuit	360Vdc-230Vac	3min	Unit can't operating, error message: SInvCurAdChaFault. No danger, no hazard, no fire.	
12	AC frequency measure(R255)	Pin1-Pin2 Short circuit	360Vdc-230Vac	3min	Unit shut down, error message: GridOverFreq Fault. No danger, no hazard, no fire.	
13	V-busmeasure (D31)	Pin2-Pin3 Short circuit	360Vdc-230Vac	3min	Unit can't operating,Error message: BusAllVoltHwOveFault. No danger, no hazard, no fire.	
14	DC current measure1(R247)	Pin1-Pin2 Short circuit	360Vdc-230Vac	3min	Unit shut down,error message: Pv1HwOverCurrFault. No danger, no hazard, no fire.	

CEI 0-21					
Clause	Requirement - Test			Result - Remark	Verdict
15	DC current measure2(R248)	Pin1-Pin2 Short circuit	360Vdc-230Vac	3min	Unit shut down,error message: Pv2HwOverCurrFault. No danger, no hazard, no fire.
16	DC current measure3(R273)	Pin1-Pin2 Short circuit	360Vdc-230Vac	3min	Unit shut down,error message: Pv3HwOverCurrFault. No danger, no hazard, no fire.
17	T measure(R180)	Pin1-Pin2 Short circuit	360Vdc-230Vac	3min	Unit can't operating,Error message: TemperatureAdChanFault.No damage, no hazard, no fire.
18	power tube Boost(Q2)	Pin2-Pin3 Short circuit before start up	360Vdc-230Vac	3min	Unit can not start up, No damage, no hazard, no fire.
19	Diode(D2)	Short circuit	360Vdc-230Vac	3min	Unit normal operation, No danger, no hazard, no fire.
20	power tube IGBT(QA5)	Pin2-Pin3 Short circuit before start up	360Vdc-230Vac	3min	Unit can't operating, error message: InvOpenTestErr. No danger, no hazard, no fire.
21	power tube IGBT(QA6)	Pin2-Pin3 Short circuit before start up	360Vdc-230Vac	3min	Unit shut down, error message: InvOpenTestErr. No danger, no hazard, no fire.
22	GFCI check	Short circuit	360Vdc-230Vac	3min	Unit shut down, error message: LeakCurrFault. No danger, no hazard, no fire.
23	Bus cap(C208)	Pin1-Pin2 Short circuit before start up	360Vdc-230Vac	3min	Unit can not start up, No damage, no hazard, no fire.
24	Transformer short circuit tests (T4)	Pin22-Pin24 Short circuit	360Vdc-230Vac	3min	Unit can not start up, No damage, no hazard, no fire.
25	Transformer short circuit tests(T4)	Pin32-Pin36 Short circuit	360Vdc-230Vac	3min	Unit can not start up, No damage, no hazard, no fire.
26	power tube MOS-SPS(Q-MOS1)	G-D Short circuit	360Vdc-230Vac	3min	SPS no output, No danger, no hazard, no fire.
27	power tube MOS-SPS(Q-MOS1)	D-S Short circuit	360Vdc-230Vac	3min	SPS no output, No danger, no hazard, no fire.
28	Output L to N	short circuit	360Vdc-230Vac	3min	Unit shut down, error message:GridUnderVoltFault. No danger, no hazard, no fire.
29	Output L to PE	short circuit	360Vdc-230Vac	3min	Unit shut down ,error message:GridLossFault. No danger, no hazard, no fire.
30	DC	--	360Vdc-230Vac	3min	Vac=0, VBAT=0
31	AC	--	360Vdc-230Vac	3min	Vdc=0, VBAT=0
32	BAT	--	360Vdc-230Vac	3min	Vdc=0, Vac=0
33	Overload	Output overload (110%)	360Vdc-230Vac	3min	Unit normal operation. No danger, no hazard, no fire.

CEI 0-21					
Clause	Requirement - Test			Result - Remark	Verdict
34	Cooling system failure – Blanketing test	Put the unit to box	360Vdc-230Vac	1 hour	1 hour power run at 50%
35	PV+ to PV-	Reverse polarity	360Vdc-230Vac	3min	Unit can not start up. No danger, no hazard, no fire.
36	Output L - N	Reverse polarity before start up	360Vdc-230Vac	3min	Unit normal operation. No danger, no hazard, no fire.
<p>Supplementary information: Tests performed under abnormal or fault conditions shall be tested with a source capable of 1,25 to 1,5 times the PCE rated maximum input current (Isc PV) for that input.</p>					

CEI 0-21			
Clause	Requirement - Test	Result - Remark	Verdict

A.4.7	TABLE: Climatic compatibility tests			P
Model	VT-6607106			
Climatic tests of unpowered equipment:				
Temperature	Relative humidity	Standards	Test time	
70°C ± 2°C	--	EN 60068-2-2	16h	
40°C ± 2°C	93% ± 3%	EN 60068-2-78	4 days	
-25°C ± 2°C	--	EN 60068-2-1	16h	
-25°C -> +70°C ± 2°C	--	EN 60068-2-14	3h @ -25°C, 3h @ +70°C	
Climatic tests of powered equipment:				
Temperature	Relative humidity	Standards	Test time	
60°C ± 2°C*	--	EN 60068-2-2	16h	
40°C ± 2°C	93% ± 3%	EN 60068-2-78	4 days	
-25°C ± 2°C	--	EN 60068-2-1	16h	
-25°C -> +60°C ± 2°C*	--	EN 60068-2-14	3h @ -25°C, 3h @ +60°C	
Note: The unit is not allowed to be damaged while testing. *If the PV inverter max operating temperature above 55°C, please use the max operating temperature in the test.				

CEI 0-21			
Clause	Requirement - Test	Result - Remark	Verdict

Temperature diagram of unpowered equipment:

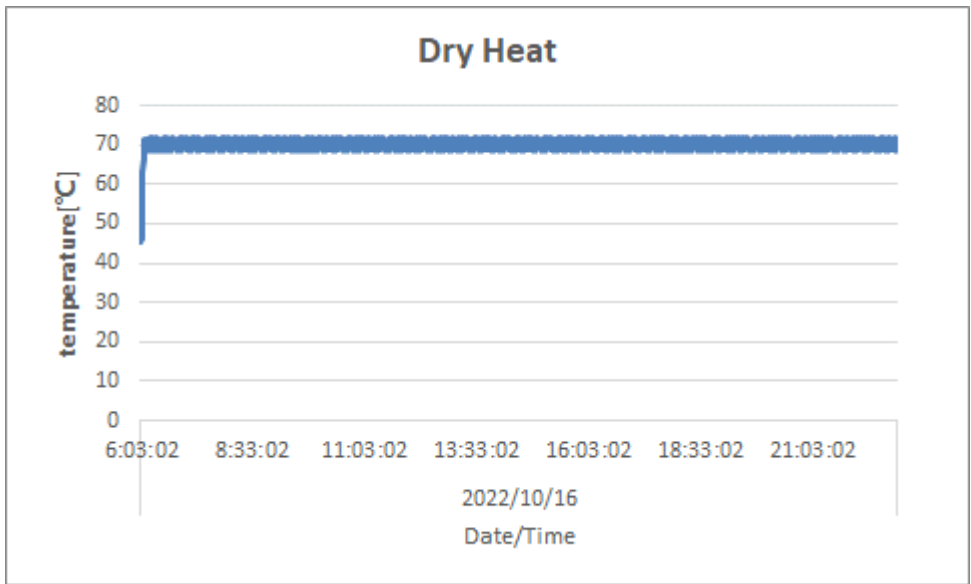

Temperature diagram of unpowered equipment:

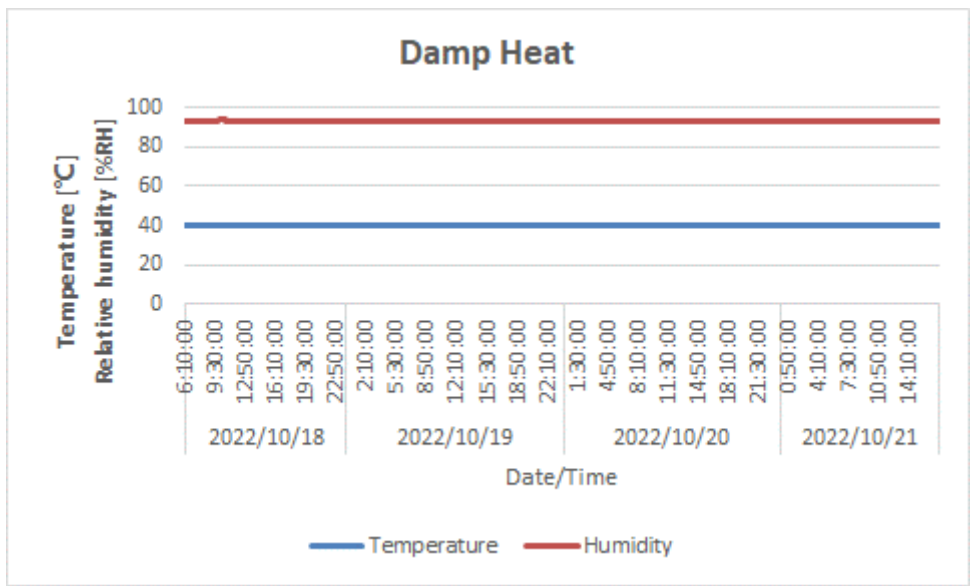

CEI 0-21			
Clause	Requirement - Test	Result - Remark	Verdict

Temperature diagram of unpowered equipment:

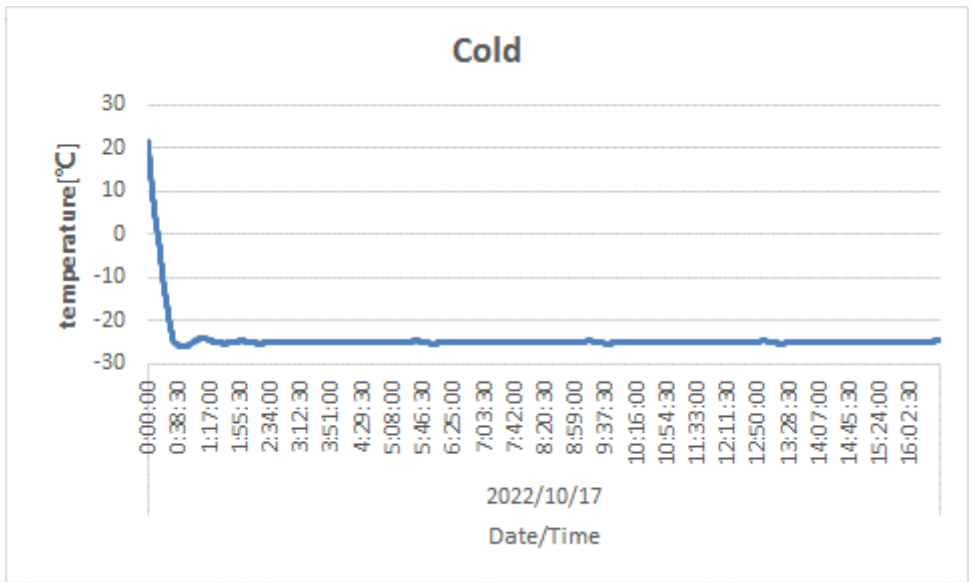

Temperature diagram of unpowered equipment:

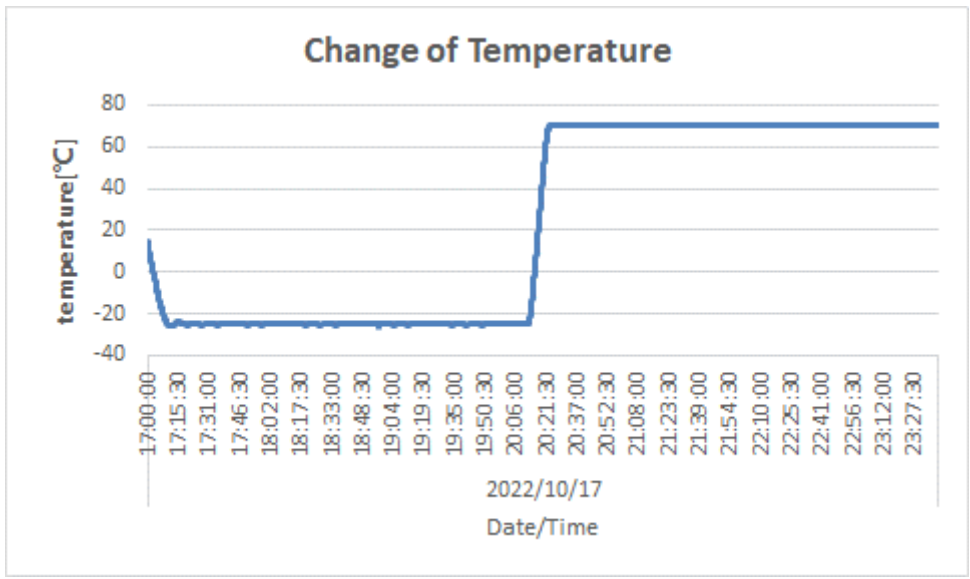

CEI 0-21			
Clause	Requirement - Test	Result - Remark	Verdict

Temperature diagram of unpowered equipment:

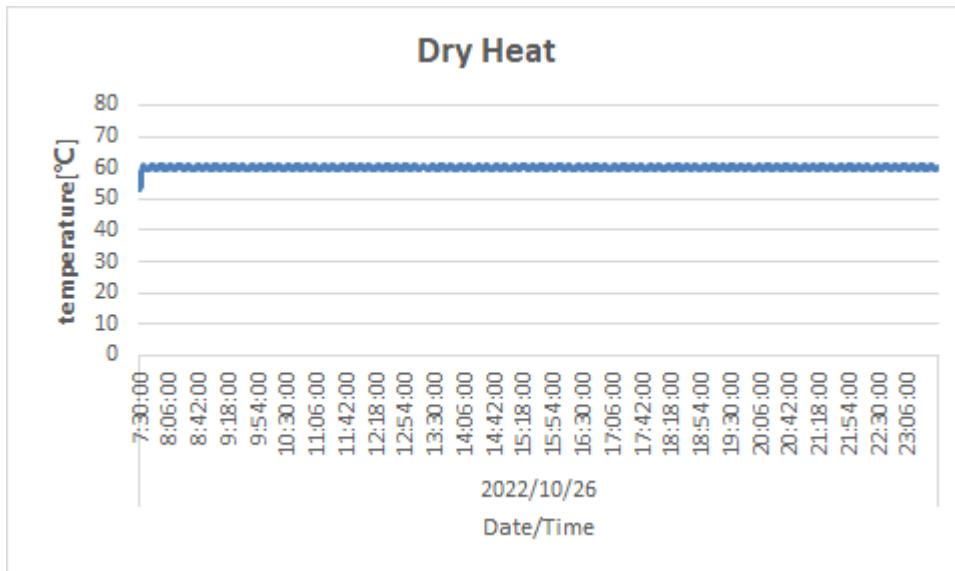

Temperature diagram of unpowered equipment:

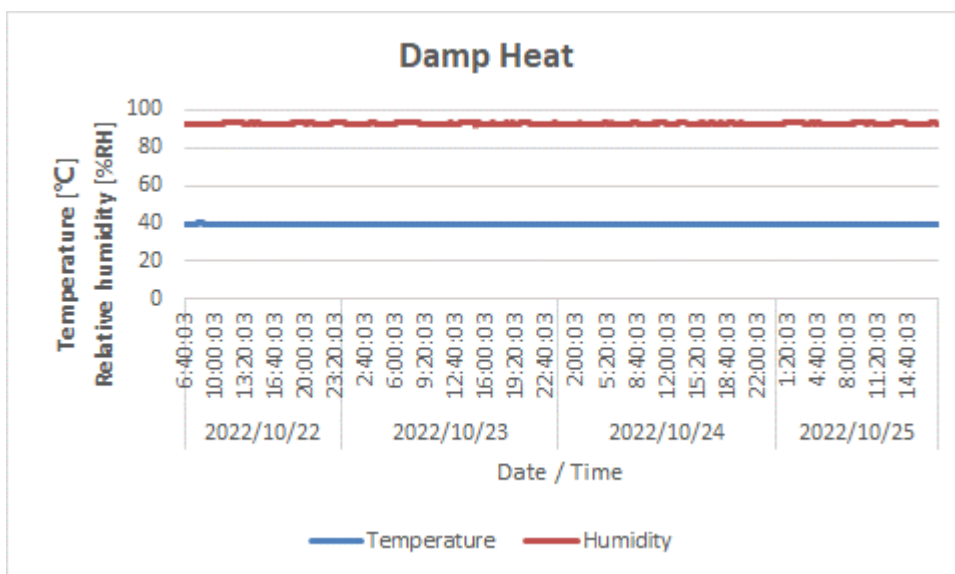

CEI 0-21			
Clause	Requirement - Test	Result - Remark	Verdict

Temperature diagram of unpowered equipment:

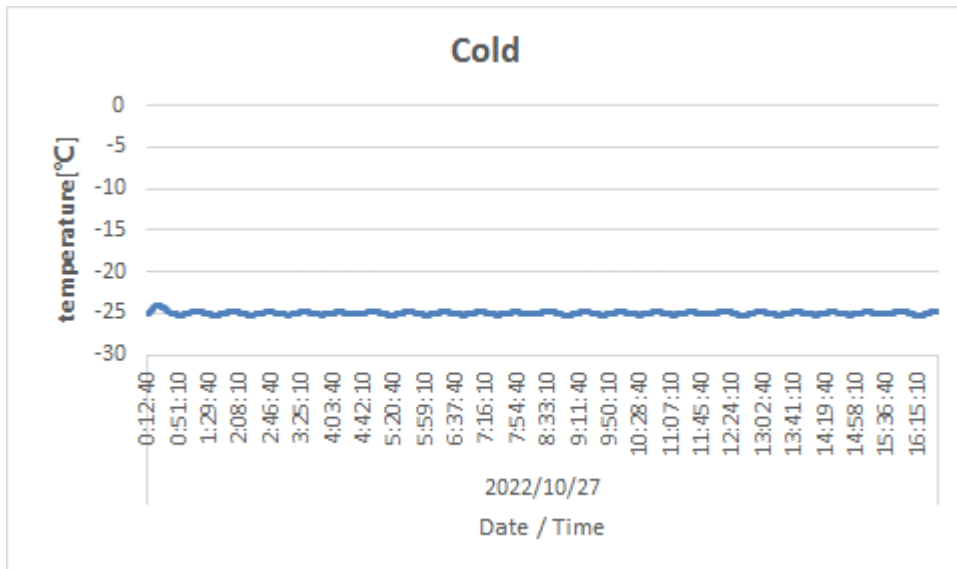

Temperature diagram of unpowered equipment:

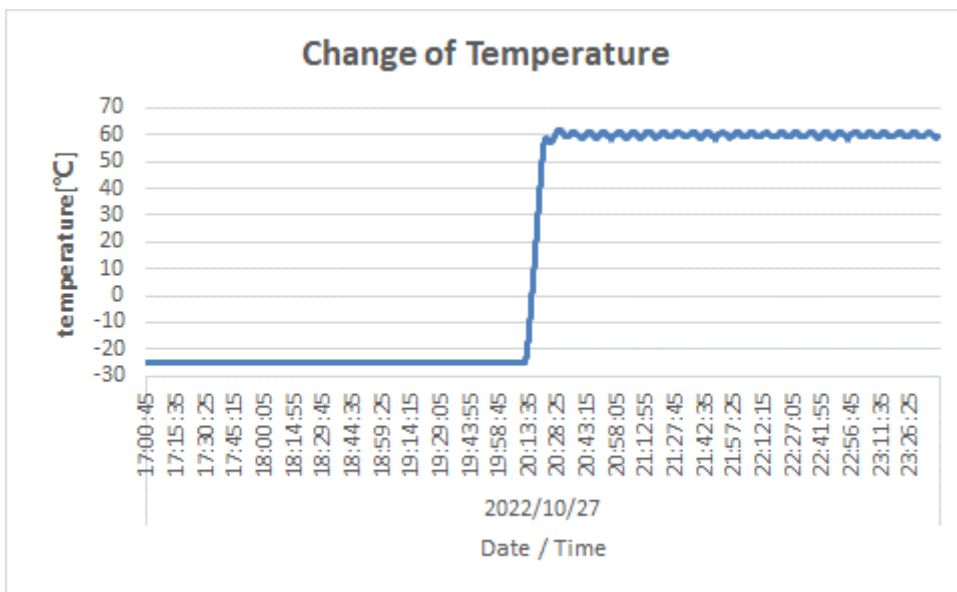

CEI 0-21			
Clause	Requirement - Test	Result - Remark	Verdict

A.4.8	TABLE: Insulation tests (CEI EN 60255-5)		P
Model	VT-6607106		
	Location	Test voltage	Result
Rigidity of electricity:			
	AC to PE	2 kVac / 2.8kVdc	P
	DC to PE	2 kVac / 2.8kVdc	P
	AC to communication port	2 kVac / 2.8kVdc	P
	DC to communication port	2 kVac / 2.8kVdc	P
Impulse test:			
	AC to PE	5 kV (1.2/50µs)	P
	DC to PE	5 kV (1.2/50µs)	P
	AC to communication port	5 kV (1.2/50µs)	P
	DC to communication port	5 kV (1.2/50µs)	P
Measurement of the insulation resistance:			
	AC to PE	>100 MΩ at 500 Vdc	P
	DC to PE	>100 MΩ at 500 Vdc	P
	AC to communication port	>100 MΩ at 500 Vdc	P
	DC to communication port	>100 MΩ at 500 Vdc	P
Note:			

CEI 0-21			
Clause	Requirement - Test	Result - Remark	Verdict

A.4.9	TABLE: Test for the overload capacity of measuring circuits		P
Model	VT-6607106		
	Voltage	Test time	Result:
	$\geq 130\%U_N$	permanent	P
	$\geq 150\%U_N$	1s	P
<p>Note: The unit is not allowed to be damaged while testing. The measurement circuit must show after the test the same values like before the test.</p>			

CEI 0-21			
Clause	Requirement - Test	Result - Remark	Verdict

A.4.11	TABLE: Automatic mechanism to prevent current imbalance during production		N/A
Model	VT-6607106		
Test No. 1			
Imbalance of power:	Test time:	Limit:	
6kW<P<10kW	30min	max. 30 min	
Test No.2			
Imbalance of power:	Test time:	Limit:	
P>10kW	1min	max. 1 min	
<p>Note:</p> <p>Test No.1</p> <ul style="list-style-type: none"> - System operating at its nominal conditions; - Creation of a permanent artificial imbalance greater than 6 kW and less than 10 kW ; - Checking the disconnection of the entire production system using the interface device (DDI) within a maximum time of 30 min. <p>Test No.2:</p> <ul style="list-style-type: none"> - System operating at its nominal conditions; - Creation of a permanent artificial imbalance greater than 10 kW ; - Checking the disconnection of the entire production system using the interface device (DDI) within a maximum time of 1 min. 			

CEI 0-21			
Clause	Requirement - Test	Result - Remark	Verdict

B.1 a) / b)	TABLE: Harmonic current emission		P
Model	VT-6607106		
<input checked="" type="checkbox"/> CEI EN 61000-3-2 <input checked="" type="checkbox"/> CEI EN 61000-3-12			
<input checked="" type="checkbox"/> Ambient temperature <input checked="" type="checkbox"/> -25°C temperature <input checked="" type="checkbox"/> +60°C temperature			
<input checked="" type="checkbox"/> 100% P _n <input checked="" type="checkbox"/> 66% P _n <input checked="" type="checkbox"/> 33% P _n			
Note: *If the EUT operating temperature out of -10°C to 55°C, please use the upper and lower operating temperature limit in the test (such as -25°C / +60°C).			

CEI 0-21				
Clause	Requirement - Test	Result - Remark	Verdict	
B1 a)/b)	TABLE: Harmonics measurement under test condition 25°C /-25°C / 60°C, 100% P_n / 66% P_n / 33% P_n (CEI EN 61000-3-12)			P
Model	VT-6607106			
Active power (W)		6072.30 (100% P _n , 60°C)		
Voltage (V)		230.00		
Current (A)		26.45		
Power Factor		0.998		
Frequency (Hz)		50.00		
Harmonics	Current Magnitude (A)	Current Percent of Fundamental (%)	Phase	Harmonic Current Limits (%)
1st	26.087	--	Single phase	--
2nd	0.096	0.369	Single phase	8
3rd	0.621	2.381	Single phase	21,6
4th	0.053	0.202	Single phase	4
5th	0.471	1.804	Single phase	10,7
6th	0.014	0.054	Single phase	2,7
7th	0.359	1.376	Single phase	7,2
8th	0.007	0.026	Single phase	2
9th	0.268	1.029	Single phase	3,8
10th	0.042	0.161	Single phase	1,6
11th	0.201	0.769	Single phase	3,1
12th	0.011	0.041	Single phase	1,3
13th	0.122	0.469	Single phase	2
14th	0.020	0.075	Single phase	N/A
15th	0.085	0.325	Single phase	N/A
16th	0.024	0.090	Single phase	N/A
17th	0.055	0.210	Single phase	N/A
18th	0.014	0.054	Single phase	N/A
19th	0.039	0.149	Single phase	N/A
20th	0.012	0.046	Single phase	N/A
21st	0.041	0.157	Single phase	N/A
22nd	0.012	0.048	Single phase	N/A
23rd	0.030	0.114	Single phase	N/A
24th	0.006	0.024	Single phase	N/A
25th	0.028	0.106	Single phase	N/A
26th	0.006	0.025	Single phase	N/A
27th	0.024	0.094	Single phase	N/A
28th	0.005	0.020	Single phase	N/A
29th	0.019	0.074	Single phase	N/A
30th	0.004	0.015	Single phase	N/A
31st	0.018	0.068	Single phase	N/A
32nd	0.004	0.016	Single phase	N/A
33rd	0.013	0.049	Single phase	N/A
34th	0.006	0.023	Single phase	N/A
35th	0.013	0.049	Single phase	N/A
36th	0.004	0.016	Single phase	N/A
37th	0.012	0.047	Single phase	N/A
38th	0.005	0.018	Single phase	N/A
39th	0.011	0.042	Single phase	N/A
40th	0.005	0.021	Single phase	N/A
THD	--	3.700	Single phase	23
PWHD	--	2.189	Single phase	23

CEI 0-21				
Clause	Requirement - Test	Result - Remark	Verdict	
B1 a)/b)	TABLE: Harmonics measurement under test condition 25°C /-25°C / 60°C, 100% P_n / 66% P_n / 33% P_n (CEI EN 61000-3-12)			P
Model	VT-6607106			
Active power (W)		6071.02 (100% P _n , -25°C)		
Voltage (V)		230.03		
Current (A)		26.44		
Power Factor		0.998		
Frequency (Hz)		50.00		
Harmonics	Current Magnitude (A)	Current Percent of Fundamental (%)	Phase	Harmonic Current Limits (%)
1st	26.087	--	Single phase	--
2nd	0.097	0.373	Single phase	8
3rd	0.617	2.366	Single phase	21,6
4th	0.052	0.201	Single phase	4
5th	0.464	1.781	Single phase	10,7
6th	0.014	0.055	Single phase	2,7
7th	0.355	1.361	Single phase	7,2
8th	0.008	0.030	Single phase	2
9th	0.264	1.011	Single phase	3,8
10th	0.039	0.150	Single phase	1,6
11th	0.197	0.754	Single phase	3,1
12th	0.010	0.038	Single phase	1,3
13th	0.121	0.463	Single phase	2
14th	0.020	0.077	Single phase	N/A
15th	0.086	0.329	Single phase	N/A
16th	0.024	0.093	Single phase	N/A
17th	0.054	0.208	Single phase	N/A
18th	0.015	0.056	Single phase	N/A
19th	0.039	0.148	Single phase	N/A
20th	0.015	0.056	Single phase	N/A
21st	0.039	0.150	Single phase	N/A
22nd	0.014	0.053	Single phase	N/A
23rd	0.030	0.114	Single phase	N/A
24th	0.008	0.030	Single phase	N/A
25th	0.027	0.102	Single phase	N/A
26th	0.007	0.028	Single phase	N/A
27th	0.024	0.091	Single phase	N/A
28th	0.006	0.024	Single phase	N/A
29th	0.019	0.072	Single phase	N/A
30th	0.004	0.016	Single phase	N/A
31st	0.016	0.063	Single phase	N/A
32nd	0.005	0.018	Single phase	N/A
33rd	0.013	0.049	Single phase	N/A
34th	0.006	0.024	Single phase	N/A
35th	0.012	0.046	Single phase	N/A
36th	0.004	0.015	Single phase	N/A
37th	0.013	0.050	Single phase	N/A
38th	0.005	0.020	Single phase	N/A
39th	0.012	0.045	Single phase	N/A
40th	0.005	0.018	Single phase	N/A
THD	--	3.700	Single phase	23
PWHD	--	2.261	Single phase	23

CEI 0-21				
Clause	Requirement - Test	Result - Remark	Verdict	
B1 a)/b)	TABLE: Harmonics measurement under test condition 25°C /-25°C / 60°C, 100% P_n / 66% P_n / 33% P_n (CEI EN 61000-3-12)			P
Model	VT-6607106			
Active power (W)		6070.70 (100% P _n , 25°C)		
Voltage (V)		230.03		
Current (A)		26.44		
Power Factor		0.998		
Frequency (Hz)		50.00		
Harmonics	Current Magnitude (A)	Current Percent of Fundamental (%)	Phase	Harmonic Current Limits (%)
1st	26.087	--	Single phase	--
2nd	0.096	0.370	Single phase	8
3rd	0.627	2.405	Single phase	21,6
4th	0.054	0.207	Single phase	4
5th	0.466	1.787	Single phase	10,7
6th	0.014	0.053	Single phase	2,7
7th	0.356	1.363	Single phase	7,2
8th	0.009	0.033	Single phase	2
9th	0.265	1.015	Single phase	3,8
10th	0.041	0.158	Single phase	1,6
11th	0.198	0.759	Single phase	3,1
12th	0.008	0.030	Single phase	1,3
13th	0.122	0.467	Single phase	2
14th	0.021	0.081	Single phase	N/A
15th	0.085	0.327	Single phase	N/A
16th	0.023	0.090	Single phase	N/A
17th	0.054	0.206	Single phase	N/A
18th	0.013	0.050	Single phase	N/A
19th	0.038	0.146	Single phase	N/A
20th	0.014	0.053	Single phase	N/A
21st	0.041	0.156	Single phase	N/A
22nd	0.012	0.047	Single phase	N/A
23rd	0.029	0.112	Single phase	N/A
24th	0.007	0.029	Single phase	N/A
25th	0.027	0.103	Single phase	N/A
26th	0.007	0.025	Single phase	N/A
27th	0.024	0.093	Single phase	N/A
28th	0.005	0.020	Single phase	N/A
29th	0.019	0.074	Single phase	N/A
30th	0.004	0.015	Single phase	N/A
31st	0.017	0.066	Single phase	N/A
32nd	0.004	0.015	Single phase	N/A
33rd	0.013	0.048	Single phase	N/A
34th	0.005	0.020	Single phase	N/A
35th	0.012	0.045	Single phase	N/A
36th	0.004	0.016	Single phase	N/A
37th	0.013	0.050	Single phase	N/A
38th	0.005	0.018	Single phase	N/A
39th	0.011	0.042	Single phase	N/A
40th	0.004	0.017	Single phase	N/A
THD	--	3.731	Single phase	23
PWHD	--	2.221	Single phase	23

CEI 0-21				
Clause	Requirement - Test	Result - Remark	Verdict	
B1 a)/b)	TABLE: Harmonics measurement under test condition 25°C /-25°C / 60°C, 100% P_n / 66% P_n / 33% P_n (CEI EN 61000-3-12)			P
Model	VT-6607106			
Active power (W)		4026.52 (66% P _n , 60°C)		
Voltage (V)		230.15		
Current (A)		17.55		
Power Factor		0.997		
Frequency (Hz)		50.00		
Harmonics	Current Magnitude (A)	Current Percent of Fundamental (%)	Phase	Harmonic Current Limits (%)
1st	17.217	--	Single phase	--
2nd	0.080	0.466	Single phase	8
3rd	0.563	3.268	Single phase	21,6
4th	0.030	0.176	Single phase	4
5th	0.418	2.425	Single phase	10,7
6th	0.011	0.063	Single phase	2,7
7th	0.297	1.728	Single phase	7,2
8th	0.015	0.085	Single phase	2
9th	0.204	1.187	Single phase	3,8
10th	0.009	0.051	Single phase	1,6
11th	0.133	0.770	Single phase	3,1
12th	0.014	0.083	Single phase	1,3
13th	0.077	0.450	Single phase	2
14th	0.011	0.064	Single phase	N/A
15th	0.066	0.383	Single phase	N/A
16th	0.014	0.079	Single phase	N/A
17th	0.052	0.305	Single phase	N/A
18th	0.017	0.098	Single phase	N/A
19th	0.042	0.242	Single phase	N/A
20th	0.009	0.050	Single phase	N/A
21st	0.037	0.214	Single phase	N/A
22nd	0.007	0.039	Single phase	N/A
23rd	0.027	0.158	Single phase	N/A
24th	0.006	0.032	Single phase	N/A
25th	0.021	0.124	Single phase	N/A
26th	0.004	0.023	Single phase	N/A
27th	0.015	0.088	Single phase	N/A
28th	0.004	0.022	Single phase	N/A
29th	0.012	0.070	Single phase	N/A
30th	0.005	0.030	Single phase	N/A
31st	0.010	0.060	Single phase	N/A
32nd	0.005	0.026	Single phase	N/A
33rd	0.006	0.035	Single phase	N/A
34th	0.005	0.031	Single phase	N/A
35th	0.007	0.040	Single phase	N/A
36th	0.004	0.023	Single phase	N/A
37th	0.010	0.060	Single phase	N/A
38th	0.004	0.025	Single phase	N/A
39th	0.009	0.052	Single phase	N/A
40th	0.004	0.021	Single phase	N/A
THD	--	4.871	Single phase	23
PWHD	--	2.865	Single phase	23

CEI 0-21				
Clause	Requirement - Test	Result - Remark	Verdict	
B1 a)/b)	TABLE: Harmonics measurement under test condition 25°C /-25°C / 60°C, 100% P_n / 66% P_n / 33% P_n (CEI EN 61000-3-12)			P
Model	VT-6607106			
Active power (W)		4026.17 (66% P _n , -25°C)		
Voltage (V)		230.15		
Current (A)		17.55		
Power Factor		0.997		
Frequency (Hz)		50.00		
Harmonics	Current Magnitude (A)	Current Percent of Fundamental (%)	Phase	Harmonic Current Limits (%)
1st	17.217	--	Single phase	--
2nd	0.079	0.458	Single phase	8
3rd	0.561	3.259	Single phase	21,6
4th	0.031	0.178	Single phase	4
5th	0.417	2.423	Single phase	10,7
6th	0.012	0.068	Single phase	2,7
7th	0.296	1.721	Single phase	7,2
8th	0.015	0.087	Single phase	2
9th	0.205	1.191	Single phase	3,8
10th	0.009	0.050	Single phase	1,6
11th	0.132	0.768	Single phase	3,1
12th	0.014	0.083	Single phase	1,3
13th	0.076	0.442	Single phase	2
14th	0.008	0.049	Single phase	N/A
15th	0.066	0.385	Single phase	N/A
16th	0.013	0.075	Single phase	N/A
17th	0.052	0.304	Single phase	N/A
18th	0.016	0.091	Single phase	N/A
19th	0.043	0.248	Single phase	N/A
20th	0.008	0.045	Single phase	N/A
21st	0.038	0.219	Single phase	N/A
22nd	0.007	0.041	Single phase	N/A
23rd	0.028	0.161	Single phase	N/A
24th	0.004	0.025	Single phase	N/A
25th	0.022	0.126	Single phase	N/A
26th	0.004	0.023	Single phase	N/A
27th	0.016	0.095	Single phase	N/A
28th	0.004	0.021	Single phase	N/A
29th	0.013	0.073	Single phase	N/A
30th	0.005	0.030	Single phase	N/A
31st	0.010	0.059	Single phase	N/A
32nd	0.004	0.024	Single phase	N/A
33rd	0.006	0.034	Single phase	N/A
34th	0.004	0.021	Single phase	N/A
35th	0.007	0.039	Single phase	N/A
36th	0.004	0.021	Single phase	N/A
37th	0.010	0.060	Single phase	N/A
38th	0.005	0.029	Single phase	N/A
39th	0.008	0.048	Single phase	N/A
40th	0.004	0.022	Single phase	N/A
THD	--	4.842	Single phase	23
PWHD	--	2.859	Single phase	23

CEI 0-21			
Clause	Requirement - Test	Result - Remark	Verdict

B1 a)/b)		TABLE: Harmonics measurement under test condition 25°C /-25°C / 60°C, 100% P _n / 66% P _n / 33% P _n (CEI EN 61000-3-12)			P
Model		VT-6607106			
Active power (W)		4025.66 (66% P _n , 25°C)			
Voltage (V)		230.16			
Current (A)		17.54			
Power Factor		0.997			
Frequency (Hz)		50.00			
Harmonics	Current Magnitude (A)	Current Percent of Fundamental (%)	Phase	Harmonic Current Limits (%)	
1st	17.217	--	Single phase	--	
2nd	0.080	0.466	Single phase	8	
3rd	0.560	3.253	Single phase	21,6	
4th	0.031	0.180	Single phase	4	
5th	0.416	2.413	Single phase	10,7	
6th	0.013	0.075	Single phase	2,7	
7th	0.295	1.714	Single phase	7,2	
8th	0.014	0.084	Single phase	2	
9th	0.204	1.187	Single phase	3,8	
10th	0.008	0.046	Single phase	1,6	
11th	0.132	0.767	Single phase	3,1	
12th	0.015	0.088	Single phase	1,3	
13th	0.078	0.452	Single phase	2	
14th	0.010	0.059	Single phase	N/A	
15th	0.067	0.388	Single phase	N/A	
16th	0.015	0.086	Single phase	N/A	
17th	0.053	0.306	Single phase	N/A	
18th	0.017	0.100	Single phase	N/A	
19th	0.042	0.242	Single phase	N/A	
20th	0.009	0.050	Single phase	N/A	
21st	0.037	0.214	Single phase	N/A	
22nd	0.008	0.044	Single phase	N/A	
23rd	0.027	0.158	Single phase	N/A	
24th	0.005	0.027	Single phase	N/A	
25th	0.021	0.120	Single phase	N/A	
26th	0.005	0.027	Single phase	N/A	
27th	0.016	0.091	Single phase	N/A	
28th	0.004	0.023	Single phase	N/A	
29th	0.013	0.074	Single phase	N/A	
30th	0.005	0.027	Single phase	N/A	
31st	0.009	0.052	Single phase	N/A	
32nd	0.005	0.029	Single phase	N/A	
33rd	0.006	0.037	Single phase	N/A	
34th	0.004	0.025	Single phase	N/A	
35th	0.006	0.038	Single phase	N/A	
36th	0.003	0.020	Single phase	N/A	
37th	0.010	0.055	Single phase	N/A	
38th	0.005	0.026	Single phase	N/A	
39th	0.009	0.053	Single phase	N/A	
40th	0.004	0.023	Single phase	N/A	
THD	--	4.860	Single phase	23	
PWHD	--	2.851	Single phase	23	

CEI 0-21				
Clause	Requirement - Test	Result - Remark	Verdict	
B1 a)/b)	TABLE: Harmonics measurement under test condition 25°C /-25°C / 60°C, 100% P_n / 66% P_n / 33% P_n (CEI EN 61000-3-12)			P
Model	VT-6607106			
Active power (W)		2014.49 (33% P _n , 60°C)		
Voltage (V)		229.96		
Current (A)		8.83		
Power Factor		0.992		
Frequency (Hz)		50.00		
Harmonics	Current Magnitude (A)	Current Percent of Fundamental (%)	Phase	Harmonic Current Limits (%)
1st	8.609	--	Single phase	--
2nd	0.031	0.354	Single phase	8
3rd	0.524	6.090	Single phase	21,6
4th	0.009	0.106	Single phase	4
5th	0.321	3.730	Single phase	10,7
6th	0.013	0.151	Single phase	2,7
7th	0.176	2.045	Single phase	7,2
8th	0.026	0.301	Single phase	2
9th	0.118	1.373	Single phase	3,8
10th	0.013	0.156	Single phase	1,6
11th	0.081	0.936	Single phase	3,1
12th	0.006	0.066	Single phase	1,3
13th	0.041	0.476	Single phase	2
14th	0.007	0.077	Single phase	N/A
15th	0.032	0.371	Single phase	N/A
16th	0.004	0.049	Single phase	N/A
17th	0.017	0.196	Single phase	N/A
18th	0.006	0.066	Single phase	N/A
19th	0.010	0.121	Single phase	N/A
20th	0.005	0.059	Single phase	N/A
21st	0.014	0.165	Single phase	N/A
22nd	0.008	0.096	Single phase	N/A
23rd	0.007	0.081	Single phase	N/A
24th	0.006	0.071	Single phase	N/A
25th	0.012	0.135	Single phase	N/A
26th	0.003	0.041	Single phase	N/A
27th	0.013	0.151	Single phase	N/A
28th	0.004	0.046	Single phase	N/A
29th	0.010	0.112	Single phase	N/A
30th	0.005	0.062	Single phase	N/A
31st	0.008	0.090	Single phase	N/A
32nd	0.004	0.045	Single phase	N/A
33rd	0.005	0.062	Single phase	N/A
34th	0.004	0.042	Single phase	N/A
35th	0.005	0.058	Single phase	N/A
36th	0.005	0.055	Single phase	N/A
37th	0.007	0.082	Single phase	N/A
38th	0.003	0.039	Single phase	N/A
39th	0.006	0.075	Single phase	N/A
40th	0.005	0.055	Single phase	N/A
THD	--	7.968	Single phase	23
PWHD	--	2.708	Single phase	23

CEI 0-21				
Clause	Requirement - Test	Result - Remark	Verdict	
B1 a)/b)	TABLE: Harmonics measurement under test condition 25°C /-25°C / 60°C, 100% P_n / 66% P_n / 33% P_n (CEI EN 61000-3-12)			P
Model	VT-6607106			
Active power (W)		2009.97 (33% P _n , -25°C)		
Voltage (V)		229.97		
Current (A)		8.81		
Power Factor		0.992		
Frequency (Hz)		50.00		
Harmonics	Current Magnitude (A)	Current Percent of Fundamental (%)	Phase	Harmonic Current Limits (%)
1st	8.609	--	Single phase	--
2nd	0.031	0.358	Single phase	8
3rd	0.527	6.122	Single phase	21,6
4th	0.010	0.118	Single phase	4
5th	0.322	3.738	Single phase	10,7
6th	0.014	0.159	Single phase	2,7
7th	0.177	2.053	Single phase	7,2
8th	0.026	0.301	Single phase	2
9th	0.117	1.355	Single phase	3,8
10th	0.013	0.147	Single phase	1,6
11th	0.080	0.931	Single phase	3,1
12th	0.005	0.061	Single phase	1,3
13th	0.041	0.475	Single phase	2
14th	0.007	0.080	Single phase	N/A
15th	0.031	0.362	Single phase	N/A
16th	0.005	0.052	Single phase	N/A
17th	0.016	0.185	Single phase	N/A
18th	0.006	0.070	Single phase	N/A
19th	0.010	0.119	Single phase	N/A
20th	0.005	0.058	Single phase	N/A
21st	0.014	0.164	Single phase	N/A
22nd	0.008	0.094	Single phase	N/A
23rd	0.007	0.082	Single phase	N/A
24th	0.005	0.063	Single phase	N/A
25th	0.011	0.133	Single phase	N/A
26th	0.004	0.043	Single phase	N/A
27th	0.013	0.155	Single phase	N/A
28th	0.004	0.048	Single phase	N/A
29th	0.009	0.106	Single phase	N/A
30th	0.005	0.063	Single phase	N/A
31st	0.008	0.090	Single phase	N/A
32nd	0.004	0.048	Single phase	N/A
33rd	0.006	0.070	Single phase	N/A
34th	0.004	0.045	Single phase	N/A
35th	0.005	0.055	Single phase	N/A
36th	0.004	0.050	Single phase	N/A
37th	0.007	0.083	Single phase	N/A
38th	0.004	0.044	Single phase	N/A
39th	0.007	0.077	Single phase	N/A
40th	0.004	0.047	Single phase	N/A
THD	--	7.950	Single phase	23
PWHD	--	2.694	Single phase	23

CEI 0-21				
Clause	Requirement - Test	Result - Remark	Verdict	
B1 a)/b)	TABLE: Harmonics measurement under test condition 25°C /-25°C / 60°C, 100% P_n / 66% P_n / 33% P_n (CEI EN 61000-3-12)			P
Model	VT-6607106			
Active power (W)		2015.11 (33% P _n , 25°C)		
Voltage (V)		229.97		
Current (A)		8.83		
Power Factor		0.992		
Frequency (Hz)		50.00		
Harmonics	Current Magnitude (A)	Current Percent of Fundamental (%)	Phase	Harmonic Current Limits (%)
1st	8.609	--	Single phase	--
2nd	0.033	0.381	Single phase	8
3rd	0.523	6.075	Single phase	21,6
4th	0.009	0.101	Single phase	4
5th	0.322	3.741	Single phase	10,7
6th	0.012	0.144	Single phase	2,7
7th	0.177	2.059	Single phase	7,2
8th	0.029	0.332	Single phase	2
9th	0.118	1.368	Single phase	3,8
10th	0.014	0.164	Single phase	1,6
11th	0.080	0.924	Single phase	3,1
12th	0.006	0.070	Single phase	1,3
13th	0.041	0.478	Single phase	2
14th	0.006	0.074	Single phase	N/A
15th	0.031	0.364	Single phase	N/A
16th	0.004	0.046	Single phase	N/A
17th	0.016	0.181	Single phase	N/A
18th	0.006	0.069	Single phase	N/A
19th	0.010	0.121	Single phase	N/A
20th	0.005	0.060	Single phase	N/A
21st	0.014	0.167	Single phase	N/A
22nd	0.009	0.104	Single phase	N/A
23rd	0.008	0.088	Single phase	N/A
24th	0.006	0.070	Single phase	N/A
25th	0.012	0.139	Single phase	N/A
26th	0.004	0.041	Single phase	N/A
27th	0.014	0.158	Single phase	N/A
28th	0.004	0.047	Single phase	N/A
29th	0.010	0.118	Single phase	N/A
30th	0.005	0.062	Single phase	N/A
31st	0.008	0.094	Single phase	N/A
32nd	0.004	0.047	Single phase	N/A
33rd	0.006	0.070	Single phase	N/A
34th	0.004	0.046	Single phase	N/A
35th	0.005	0.053	Single phase	N/A
36th	0.004	0.048	Single phase	N/A
37th	0.007	0.083	Single phase	N/A
38th	0.004	0.041	Single phase	N/A
39th	0.006	0.070	Single phase	N/A
40th	0.004	0.052	Single phase	N/A
THD	--	7.971	Single phase	23
PWHD	--	2.678	Single phase	23

CEI 0-21			
Clause	Requirement - Test	Result - Remark	Verdict

B.1 a) Harmonics measurement under test condition 25°C /-25°C / 60°C (CEI EN 61000-3-2)				
60°C, 100% P_n power condition:				
Harmonic	L1 Phase (A)	L2 Phase (A)	L3 Phase (A)	Limit (A)
2nd	0.014	--	--	1.080
3rd	0.311	--	--	2.300
4th	0.010	--	--	0.430
5th	0.177	--	--	1.140
6th	0.006	--	--	0.300
7th	0.067	--	--	0.770
8th	0.008	--	--	0.230
9th	0.014	--	--	0.400
10th	0.005	--	--	0.184
11th	0.019	--	--	0.330
12th	0.004	--	--	0.153
13th	0.027	--	--	0.210
14th	0.005	--	--	0.131
15th	0.031	--	--	0.150
16th	0.005	--	--	0.115
17th	0.018	--	--	0.132
18th	0.005	--	--	0.102
19th	0.017	--	--	0.118
20th	0.003	--	--	0.092
21th	0.007	--	--	0.107
22th	0.007	--	--	0.084
23th	0.011	--	--	0.098
24th	0.003	--	--	0.077
25th	0.012	--	--	0.090
26th	0.004	--	--	0.071
27th	0.013	--	--	0.083
28th	0.004	--	--	0.066
29th	0.007	--	--	0.078
30th	0.003	--	--	0.061
31th	0.007	--	--	0.073
32th	0.003	--	--	0.058
33th	0.004	--	--	0.068
34th	0.004	--	--	0.054
35th	0.008	--	--	0.064
36th	0.003	--	--	0.051
37th	0.008	--	--	0.061
38th	0.003	--	--	0.048
39th	0.008	--	--	0.058
40th	0.003	--	--	0.046

CEI 0-21			
Clause	Requirement - Test	Result - Remark	Verdict

B.1 a) Harmonics measurement under test condition 25°C /-25°C / 60°C (CEI EN 61000-3-2)				
60°C, 66% P_n power condition:				
Harmonic	L1 Phase (A)	L2 Phase (A)	L3 Phase (A)	Limit (A)
2nd	0.013	--	--	1.080
3rd	0.331	--	--	2.300
4th	0.009	--	--	0.430
5th	0.122	--	--	1.140
6th	0.007	--	--	0.300
7th	0.020	--	--	0.770
8th	0.008	--	--	0.230
9th	0.058	--	--	0.400
10th	0.007	--	--	0.184
11th	0.057	--	--	0.330
12th	0.008	--	--	0.153
13th	0.033	--	--	0.210
14th	0.008	--	--	0.131
15th	0.017	--	--	0.150
16th	0.004	--	--	0.115
17th	0.029	--	--	0.132
18th	0.006	--	--	0.102
19th	0.028	--	--	0.118
20th	0.004	--	--	0.092
21th	0.017	--	--	0.107
22th	0.005	--	--	0.084
23th	0.017	--	--	0.098
24th	0.004	--	--	0.077
25th	0.016	--	--	0.090
26th	0.003	--	--	0.071
27th	0.016	--	--	0.083
28th	0.003	--	--	0.066
29th	0.008	--	--	0.078
30th	0.004	--	--	0.061
31th	0.010	--	--	0.073
32th	0.003	--	--	0.058
33th	0.010	--	--	0.068
34th	0.003	--	--	0.054
35th	0.009	--	--	0.064
36th	0.004	--	--	0.051
37th	0.007	--	--	0.061
38th	0.003	--	--	0.048
39th	0.009	--	--	0.058
40th	0.003	--	--	0.046

CEI 0-21			
Clause	Requirement - Test	Result - Remark	Verdict

B.1 a) Harmonics measurement under test condition 25°C /-25°C / 60°C (CEI EN 61000-3-2)				
60°C, 33% P_n power condition:				
Harmonic	L1 Phase (A)	L2 Phase (A)	L3 Phase (A)	Limit (A)
2nd	0.014	--	--	1.080
3rd	0.297	--	--	2.300
4th	0.009	--	--	0.430
5th	0.096	--	--	1.140
6th	0.009	--	--	0.300
7th	0.134	--	--	0.770
8th	0.007	--	--	0.230
9th	0.053	--	--	0.400
10th	0.008	--	--	0.184
11th	0.073	--	--	0.330
12th	0.007	--	--	0.153
13th	0.050	--	--	0.210
14th	0.007	--	--	0.131
15th	0.052	--	--	0.150
16th	0.008	--	--	0.115
17th	0.039	--	--	0.132
18th	0.004	--	--	0.102
19th	0.038	--	--	0.118
20th	0.004	--	--	0.092
21th	0.031	--	--	0.107
22th	0.005	--	--	0.084
23th	0.024	--	--	0.098
24th	0.003	--	--	0.077
25th	0.018	--	--	0.090
26th	0.004	--	--	0.071
27th	0.017	--	--	0.083
28th	0.003	--	--	0.066
29th	0.013	--	--	0.078
30th	0.004	--	--	0.061
31th	0.011	--	--	0.073
32th	0.003	--	--	0.058
33th	0.011	--	--	0.068
34th	0.003	--	--	0.054
35th	0.009	--	--	0.064
36th	0.004	--	--	0.051
37th	0.008	--	--	0.061
38th	0.003	--	--	0.048
39th	0.009	--	--	0.058
40th	0.003	--	--	0.046

CEI 0-21			
Clause	Requirement - Test	Result - Remark	Verdict

B.1 a) Harmonics measurement under test condition 25°C /-25°C / 60°C (CEI EN 61000-3-2)				
-25°C, 100% P_n power condition:				
Harmonic	L1 Phase (A)	L2 Phase (A)	L3 Phase (A)	Limit (A)
2nd	0.013	--	--	1.080
3rd	0.312	--	--	2.300
4th	0.010	--	--	0.430
5th	0.176	--	--	1.140
6th	0.006	--	--	0.300
7th	0.067	--	--	0.770
8th	0.008	--	--	0.230
9th	0.015	--	--	0.400
10th	0.006	--	--	0.184
11th	0.019	--	--	0.330
12th	0.005	--	--	0.153
13th	0.027	--	--	0.210
14th	0.005	--	--	0.131
15th	0.031	--	--	0.150
16th	0.005	--	--	0.115
17th	0.017	--	--	0.132
18th	0.005	--	--	0.102
19th	0.017	--	--	0.118
20th	0.003	--	--	0.092
21th	0.007	--	--	0.107
22th	0.006	--	--	0.084
23th	0.011	--	--	0.098
24th	0.003	--	--	0.077
25th	0.011	--	--	0.090
26th	0.004	--	--	0.071
27th	0.013	--	--	0.083
28th	0.004	--	--	0.066
29th	0.007	--	--	0.078
30th	0.003	--	--	0.061
31th	0.006	--	--	0.073
32th	0.003	--	--	0.058
33th	0.004	--	--	0.068
34th	0.004	--	--	0.054
35th	0.008	--	--	0.064
36th	0.004	--	--	0.051
37th	0.008	--	--	0.061
38th	0.003	--	--	0.048
39th	0.008	--	--	0.058
40th	0.003	--	--	0.046

CEI 0-21			
Clause	Requirement - Test	Result - Remark	Verdict

B.1 a) Harmonics measurement under test condition 25°C /-25°C / 60°C (CEI EN 61000-3-2)				
-25°C, 66% P_n power condition:				
Harmonic	L1 Phase (A)	L2 Phase (A)	L3 Phase (A)	Limit (A)
2nd	0.012	--	--	1.080
3rd	0.331	--	--	2.300
4th	0.010	--	--	0.430
5th	0.121	--	--	1.140
6th	0.006	--	--	0.300
7th	0.020	--	--	0.770
8th	0.008	--	--	0.230
9th	0.057	--	--	0.400
10th	0.007	--	--	0.184
11th	0.056	--	--	0.330
12th	0.009	--	--	0.153
13th	0.032	--	--	0.210
14th	0.008	--	--	0.131
15th	0.017	--	--	0.150
16th	0.004	--	--	0.115
17th	0.028	--	--	0.132
18th	0.005	--	--	0.102
19th	0.028	--	--	0.118
20th	0.003	--	--	0.092
21th	0.016	--	--	0.107
22th	0.004	--	--	0.084
23th	0.017	--	--	0.098
24th	0.004	--	--	0.077
25th	0.016	--	--	0.090
26th	0.003	--	--	0.071
27th	0.016	--	--	0.083
28th	0.003	--	--	0.066
29th	0.008	--	--	0.078
30th	0.004	--	--	0.061
31th	0.010	--	--	0.073
32th	0.003	--	--	0.058
33th	0.010	--	--	0.068
34th	0.003	--	--	0.054
35th	0.009	--	--	0.064
36th	0.003	--	--	0.051
37th	0.007	--	--	0.061
38th	0.003	--	--	0.048
39th	0.009	--	--	0.058
40th	0.003	--	--	0.046

CEI 0-21			
Clause	Requirement - Test	Result - Remark	Verdict

B.1 a) Harmonics measurement under test condition 25°C /-25°C / 60°C (CEI EN 61000-3-2)				
-25°C, 33% P_n power condition:				
Harmonic	L1 Phase (A)	L2 Phase (A)	L3 Phase (A)	Limit (A)
2nd	0.014	--	--	1.080
3rd	0.295	--	--	2.300
4th	0.008	--	--	0.430
5th	0.095	--	--	1.140
6th	0.010	--	--	0.300
7th	0.134	--	--	0.770
8th	0.006	--	--	0.230
9th	0.053	--	--	0.400
10th	0.008	--	--	0.184
11th	0.073	--	--	0.330
12th	0.006	--	--	0.153
13th	0.050	--	--	0.210
14th	0.007	--	--	0.131
15th	0.052	--	--	0.150
16th	0.008	--	--	0.115
17th	0.039	--	--	0.132
18th	0.004	--	--	0.102
19th	0.038	--	--	0.118
20th	0.004	--	--	0.092
21th	0.030	--	--	0.107
22th	0.004	--	--	0.084
23th	0.025	--	--	0.098
24th	0.003	--	--	0.077
25th	0.017	--	--	0.090
26th	0.004	--	--	0.071
27th	0.018	--	--	0.083
28th	0.003	--	--	0.066
29th	0.014	--	--	0.078
30th	0.003	--	--	0.061
31th	0.010	--	--	0.073
32th	0.003	--	--	0.058
33th	0.011	--	--	0.068
34th	0.003	--	--	0.054
35th	0.009	--	--	0.064
36th	0.003	--	--	0.051
37th	0.008	--	--	0.061
38th	0.003	--	--	0.048
39th	0.009	--	--	0.058
40th	0.003	--	--	0.046

CEI 0-21			
Clause	Requirement - Test	Result - Remark	Verdict

B.1 a) Harmonics measurement under test condition 25°C /-25°C / 60°C (CEI EN 61000-3-2)				
25°C, 100% P_n power condition:				
Harmonic	L1 Phase (A)	L2 Phase (A)	L3 Phase (A)	Limit (A)
2nd	0.014	--	--	1.080
3rd	0.312	--	--	2.300
4th	0.010	--	--	0.430
5th	0.177	--	--	1.140
6th	0.006	--	--	0.300
7th	0.067	--	--	0.770
8th	0.009	--	--	0.230
9th	0.014	--	--	0.400
10th	0.006	--	--	0.184
11th	0.019	--	--	0.330
12th	0.005	--	--	0.153
13th	0.027	--	--	0.210
14th	0.006	--	--	0.131
15th	0.031	--	--	0.150
16th	0.005	--	--	0.115
17th	0.018	--	--	0.132
18th	0.004	--	--	0.102
19th	0.017	--	--	0.118
20th	0.003	--	--	0.092
21th	0.008	--	--	0.107
22th	0.006	--	--	0.084
23th	0.011	--	--	0.098
24th	0.003	--	--	0.077
25th	0.011	--	--	0.090
26th	0.004	--	--	0.071
27th	0.013	--	--	0.083
28th	0.004	--	--	0.066
29th	0.007	--	--	0.078
30th	0.003	--	--	0.061
31th	0.007	--	--	0.073
32th	0.003	--	--	0.058
33th	0.004	--	--	0.068
34th	0.003	--	--	0.054
35th	0.008	--	--	0.064
36th	0.004	--	--	0.051
37th	0.008	--	--	0.061
38th	0.003	--	--	0.048
39th	0.008	--	--	0.058
40th	0.003	--	--	0.046

CEI 0-21			
Clause	Requirement - Test	Result - Remark	Verdict

Harmonics measurement under test condition 25°C /-25°C / 60°C (CEI EN 61000-3-2)				
25°C, 66% P _n power condition:				
Harmonic	L1 Phase (A)	L2 Phase (A)	L3 Phase (A)	Limit (A)
2nd	0.013	--	--	1.080
3rd	0.331	--	--	2.300
4th	0.010	--	--	0.430
5th	0.121	--	--	1.140
6th	0.006	--	--	0.300
7th	0.020	--	--	0.770
8th	0.008	--	--	0.230
9th	0.057	--	--	0.400
10th	0.007	--	--	0.184
11th	0.057	--	--	0.330
12th	0.009	--	--	0.153
13th	0.033	--	--	0.210
14th	0.007	--	--	0.131
15th	0.017	--	--	0.150
16th	0.004	--	--	0.115
17th	0.028	--	--	0.132
18th	0.005	--	--	0.102
19th	0.028	--	--	0.118
20th	0.004	--	--	0.092
21th	0.017	--	--	0.107
22th	0.004	--	--	0.084
23th	0.017	--	--	0.098
24th	0.004	--	--	0.077
25th	0.016	--	--	0.090
26th	0.003	--	--	0.071
27th	0.016	--	--	0.083
28th	0.003	--	--	0.066
29th	0.008	--	--	0.078
30th	0.003	--	--	0.061
31th	0.010	--	--	0.073
32th	0.003	--	--	0.058
33th	0.010	--	--	0.068
34th	0.003	--	--	0.054
35th	0.009	--	--	0.064
36th	0.004	--	--	0.051
37th	0.007	--	--	0.061
38th	0.003	--	--	0.048
39th	0.010	--	--	0.058
40th	0.003	--	--	0.046

CEI 0-21			
Clause	Requirement - Test	Result - Remark	Verdict

Harmonics measurement under test condition 25°C /-25°C / 60°C (CEI EN 61000-3-2)				
25°C, 33% P _n power condition:				
Harmonic	L1 Phase (A)	L2 Phase (A)	L3 Phase (A)	Limit (A)
2nd	0.013	--	--	1.080
3rd	0.295	--	--	2.300
4th	0.008	--	--	0.430
5th	0.095	--	--	1.140
6th	0.010	--	--	0.300
7th	0.134	--	--	0.770
8th	0.007	--	--	0.230
9th	0.053	--	--	0.400
10th	0.008	--	--	0.184
11th	0.073	--	--	0.330
12th	0.007	--	--	0.153
13th	0.051	--	--	0.210
14th	0.007	--	--	0.131
15th	0.053	--	--	0.150
16th	0.008	--	--	0.115
17th	0.039	--	--	0.132
18th	0.004	--	--	0.102
19th	0.038	--	--	0.118
20th	0.004	--	--	0.092
21th	0.031	--	--	0.107
22th	0.004	--	--	0.084
23th	0.025	--	--	0.098
24th	0.003	--	--	0.077
25th	0.017	--	--	0.090
26th	0.004	--	--	0.071
27th	0.017	--	--	0.083
28th	0.003	--	--	0.066
29th	0.013	--	--	0.078
30th	0.003	--	--	0.061
31th	0.010	--	--	0.073
32th	0.003	--	--	0.058
33th	0.011	--	--	0.068
34th	0.003	--	--	0.054
35th	0.009	--	--	0.064
36th	0.004	--	--	0.051
37th	0.008	--	--	0.061
38th	0.003	--	--	0.048
39th	0.008	--	--	0.058
40th	0.003	--	--	0.046

CEI 0-21			
Clause	Requirement - Test	Result - Remark	Verdict

B1 c)	TABLE: Flicker emission			P
Model	VT-6607106			
Normal ambient				
Output power:	Flicker limits according to*:	Result:		
		Plt	Pst	dc%
33%	EN61000-3-3 / EN61000-3-11	0.101	0.107	0.023
66%	EN61000-3-3 / EN61000-3-11	0.099	0.105	0.024
100%	EN61000-3-3 / EN61000-3-11	0.103	0.108	0.061
Minimum ambient rating or -25°C				
Output power:	Flicker limits according to*:	Result:		
		Plt	Pst	dc%
33%	EN61000-3-3 / EN61000-3-11	0.099	0.105	0.024
66%	EN61000-3-3 / EN61000-3-11	0.103	0.108	0.089
100%	EN61000-3-3 / EN61000-3-11	0.116	0.137	0.024
Maximum ambient rating or 60°C				
Output power:	Flicker limits according to*:	Result:		
		Plt	Pst	dc%
33%	EN61000-3-3 / EN61000-3-11	0.098	0.104	0.024
66%	EN61000-3-3 / EN61000-3-11	0.102	0.107	0.088
100%	EN61000-3-3 / EN61000-3-11	0.116	0.137	0.023
<p>Note:</p> <p>* Mains Impedance according EN61000-3-3 / EN61000-3-11: $R_{max} = \Omega$; $jX_{max} = \Omega @50Hz$ ($Z_{max} = \Omega$)</p> <p>Calculation of the maximum permissible grid impedance at the point of common coupling based on dc: $Z_{max} = Z_{ref} * 3,3\% / d_c(P_n)$</p> <p>The tests should be based on the limits of the EN61000-3-3 for less than 16A and on EN 61000-3-11 for more than 16A.</p> <p>If the EUT operating temperature out of -10°C to 55°C, please use the upper and lower operating temperature limit in the test (such as -25°C / +60°C).</p>				

CEI 0-21											
Clause	Requirement - Test						Result - Remark		Verdict		
	dc[%]			dmax[%]			d(t)[ms]	Pst	Plt		
Limit	3.30			4.00			500	1.00	0.65		
							3.30%		N:12		
No. 1	0.010	Pass		0.304	Pass		0.0	Pass	0.107	Pass	
2	0.020	Pass		0.301	Pass		0.0	Pass	0.105	Pass	
3	0.016	Pass		0.282	Pass		0.0	Pass	0.106	Pass	
4	0.018	Pass		0.341	Pass		0.0	Pass	0.105	Pass	
5	0.020	Pass		0.280	Pass		0.0	Pass	0.103	Pass	
6	0.013	Pass		0.364	Pass		0.0	Pass	0.103	Pass	
7	0.016	Pass		0.321	Pass		0.0	Pass	0.102	Pass	
8	0.020	Pass		0.316	Pass		0.0	Pass	0.100	Pass	
9	0.015	Pass		0.336	Pass		0.0	Pass	0.127	Pass	
10	0.023	Pass		0.345	Pass		0.0	Pass	0.137	Pass	
11	0.016	Pass		0.293	Pass		0.0	Pass	0.136	Pass	
12	0.014	Pass		0.361	Pass		0.0	Pass	0.136	Pass	
Result		Pass			Pass			Pass		0.116	Pass

CEI 0-21			
Clause	Requirement - Test	Result - Remark	Verdict

B.1.1	TABLE: Conditions of connection, reconnection and gradual power supply		P
Model	VT-6607106		
Test:			
Power meter measurement-data:	Sample-Rate:	0.2 s	
	Sample time:	6400	
Voltage conditons			
a) Out of voltage range	84% U_n for 30s	111% U_n for 30s	
Connection:	No connection	No connection	
Limit	No connection allowed		
b) In voltage range at start-up	85% $U_n < U < 110\% U_n$		
Reconnection time [s]	33.4	31.0	
Limit:	Reconnection after 30s		
Gradient:	Gradient should be recorded for at least 300s until the inverter has the full output power. Max gradient: 20%Pn/min For recorded gradient see diagram underneath		
c) In voltage range after voltage failure	85% $U_n < U < 110\% U_n$		
Reconnection time [s]	304.2	303.6	
Limit:	Reconnection after 300s		
Gradient:	Gradient should be recorded for at least 300s until the inverter has the full output power. Max gradient: 20%Pn/min For recorded gradient see diagram underneath		
Frequency conditions			
d) Out of frequency range	49,88 ± 0,01	50,12 ± 0,01	
Connection:	No connection	No connection	
Limit	No connection allowed		
e) In frequency range at start-up	49,90 Hz < f < 50,10		
Reconnection time [s]	33.8	31.2	
Limit:	Reconnection after 30s		
Gradient:	Gradient should be recorded for at least 300s until the inverter has the full output power. Max gradient: 20%Pn/min For recorded gradient see diagram underneath		
f) In frequency range after frequency failure	49,90 Hz < f < 50,10		
Reconnection time [s]	304.2	303.4	
Limit:	Reconnection after 300s		
Gradient:	Gradient should be recorded for at least 300s until the inverter has the full output power. Max gradient: 20%Pn/min For recorded gradient see diagram underneath		
file name a) b) and c):			

CEI 0-21			
Clause	Requirement - Test	Result - Remark	Verdict

file name d), e) and f):			
Changable reconnection conditions:		Frequency range: 49Hz-51Hz in 0,05Hz steps (default value: 49,90 and 50,10Hz)	Reconnection time range: 0-900s in steps of 5s (default value: 300s)

Test:

Test condition b) and c): voltage within the limits of 85% to 110%U_n
 Test condition e) and f): frequency within the limits of 49,90Hz to 50,10Hz
 Max deviation of the gradient: +2,5%P_n

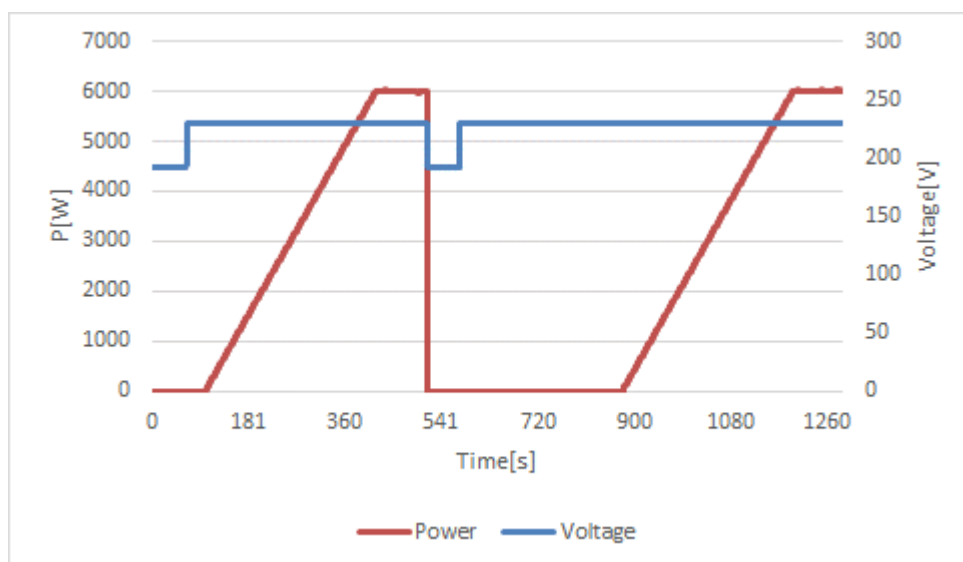
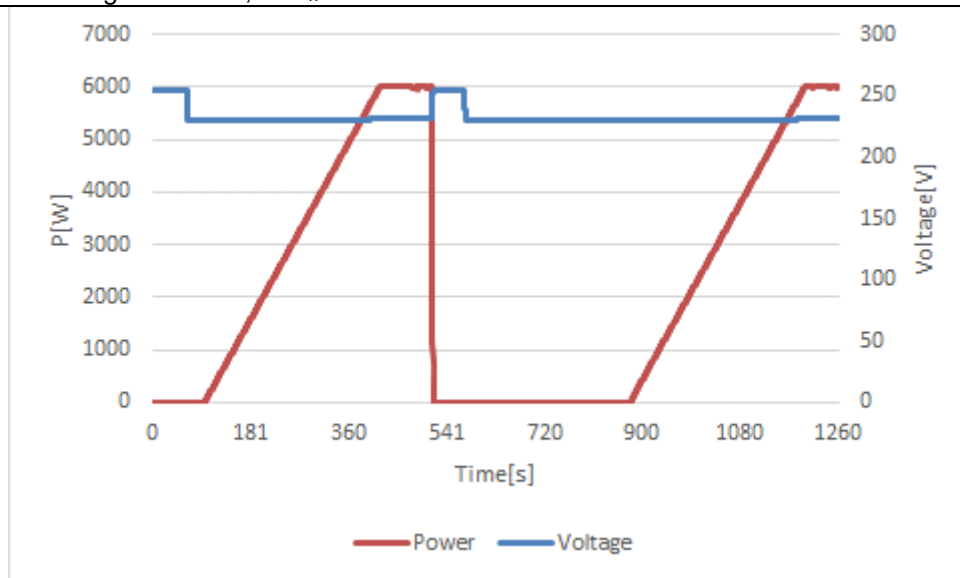

CEI 0-21			
Clause	Requirement - Test	Result - Remark	Verdict

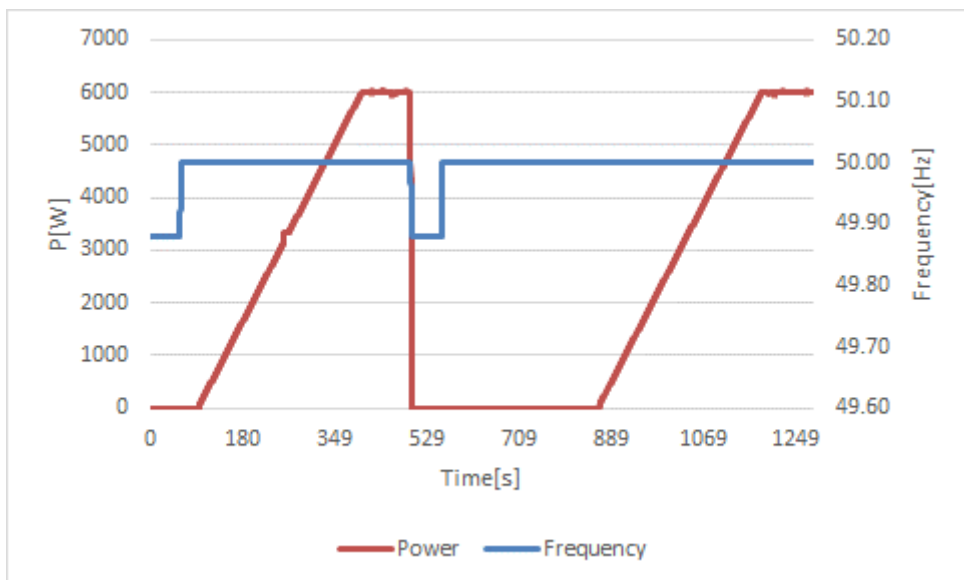
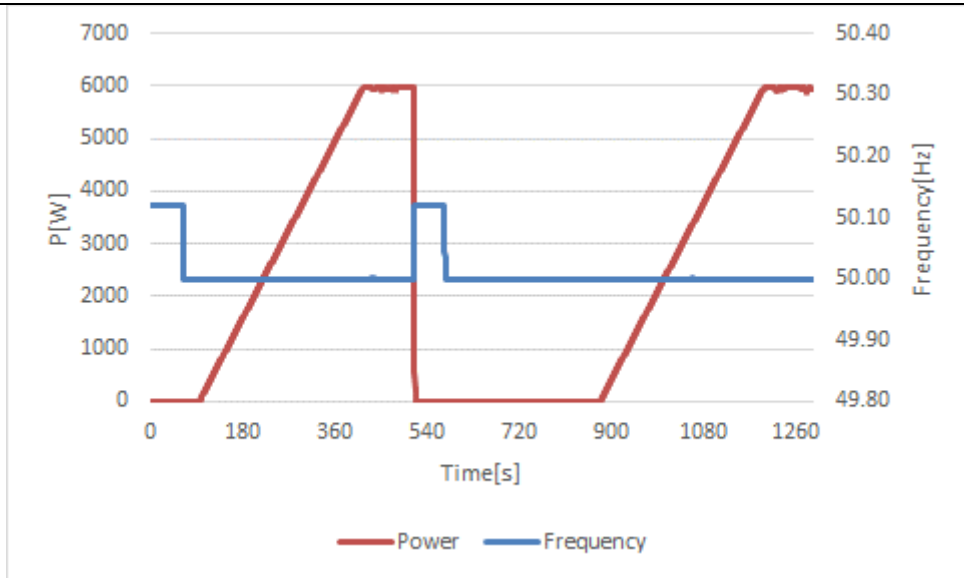

CEI 0-21			
Clause	Requirement - Test	Result - Remark	Verdict

B.1.2.2.2	TABLE: Reactive power capability - Inverter in systems with total capacity greater than 11.08 kW						P
Model	VT-6607106						
TABLE: Reactive power production with set point Q = 0							
Power-Bin	Active Power		Reactive Power		DC Power		Power Factor
	W	p.u.	VAr	p.u.	W	p.u.	Cos ϕ
0% -10%(*)	539	8.99%	-118	-1.96%	671	11.19%	0.9770
10% -20%(**)	1147	19.12%	-123	-2.06%	1283	21.38%	0.9943
20% -30%	1754	29.24%	-136	-2.26%	1901	31.68%	0.9970
30% -40%	2300	38.34%	-147	-2.45%	2455	40.91%	0.9980
40% -50%	2907	48.45%	-159	-2.65%	3072	51.21%	0.9985
50% -60%	3513	58.55%	-171	-2.85%	3692	61.53%	0.9988
60% -70%	4119	68.65%	-183	-3.05%	4309	71.82%	0.9990
70% -80%	4724	78.74%	-197	-3.29%	4929	82.16%	0.9991
80% -90%	5329	88.82%	-212	-3.54%	5550	92.50%	0.9992
90% -100%(***)	5931	98.85%	-231	-3.85%	6168	102.80%	0.9992
TABLE: Reactive power production with set point Q = -Q_{max} (>11.08 kW)							
Power-Bin	Active Power		Reactive Power		DC Power		Power Factor
	W	p.u.	VAr	p.u.	W	p.u.	Cos ϕ
0% -10%(*)	543	9.05%	-157	-2.62%	623	10.39%	0.9604
10% -20%(**)	1155	19.24%	-162	-2.69%	1240	20.66%	0.9903
20% -30%	1765	29.42%	-2910	-48.50%	1871	31.19%	0.5183
30% -40%	2315	38.58%	-2915	-48.58%	2433	40.55%	0.6216
40% -50%	2926	48.76%	-2916	-48.60%	3059	50.99%	0.7078
50% -60%	3536	58.93%	-2920	-48.67%	3686	61.43%	0.7706
60% -70%	4146	69.09%	-2926	-48.77%	4314	71.89%	0.8166
70% -80%	4755	79.25%	-2930	-48.83%	4941	82.35%	0.8510
80% -90%	5364	89.40%	-2934	-48.89%	5570	92.83%	0.8770
90% -100%(***)	5439	90.65%	-2938	-48.97%	5636	93.93%	0.8795
TABLE: Reactive power production with set point Q =+Q_{max} (>11.08 kW)							
Power-Bin	Active Power		Reactive Power		DC Power		Power Factor
	W	p.u.	VAr	p.u.	W	p.u.	Cos ϕ
0% -10%(*)	544	9.06%	-144	-2.39%	596	9.93%	0.9669
10% -20%(**)	1156	19.26%	-147	-2.45%	1212	20.19%	0.9920
20% -30%	1768	29.47%	2918	48.64%	1824	30.40%	0.5179

CEI 0-21							
Clause	Requirement - Test				Result - Remark		Verdict
30% -40%	2318	38.64%	2923	48.71%	2382	39.69%	0.6210
40% -50%	2930	48.83%	2925	48.75%	3000	50.00%	0.7072
50% -60%	3539	58.99%	2932	48.86%	3627	60.45%	0.7697
60% -70%	4150	69.17%	2939	48.98%	4255	70.92%	0.8157
70% -80%	4762	79.36%	2944	49.07%	4885	81.42%	0.8501
80% -90%	5374	89.57%	2949	49.14%	5518	91.97%	0.8764
90% -100%(***)	5602	93.37%	2955	49.26%	5755	95.92%	0.8841

Note:

The PV inverter maximum reactive power set point $Q = 48.43\%P_D$.

(*) For power outputs less than 10% of the nominal power the generator must not exchange a reactive power higher than 10% of the nominal power.

(**) For power outputs less than 20% of the nominal power the generator must not exchange a reactive power higher than 10% of the nominal power.

(***) Ensure that the minimum requirement for cos is sustained steadily when thermal balance is achieved.

CEI 0-21			
Clause	Requirement - Test	Result - Remark	Verdict

B.1.2.3			TABLE: Reactive power supply at an assigned level (greater 11.08 kW systems, but can requested for smaller systems as well)		P
Model	VT-6607106				
Power meter measurement data:	Sample-Rate:	0.2 s			
	Samples time:	3 min for each power point			
P _N in %	Q _{min} /cosφ min (180s)	Q=0/ cosφ=0 (180s)	Q _{max} /cosφ max (180s)		
50% P _N	Reactive power Set point Q/P _N [%]	Reactive power measured Q/P _N [%]	Deviation from set point ΔQ/P _N [%]	Limit [%]	
-Q _{min}	-50.00%	-50.70%	0.70%	ΔQ ≤ ±2.5% P _N	
0	0.00%	-2.30%	2.30%	ΔQ ≤ ±2.5% P _N	
+Q _{max}	50.00%	50.41%	-0.41%	ΔQ ≤ ±2.5% P _N	

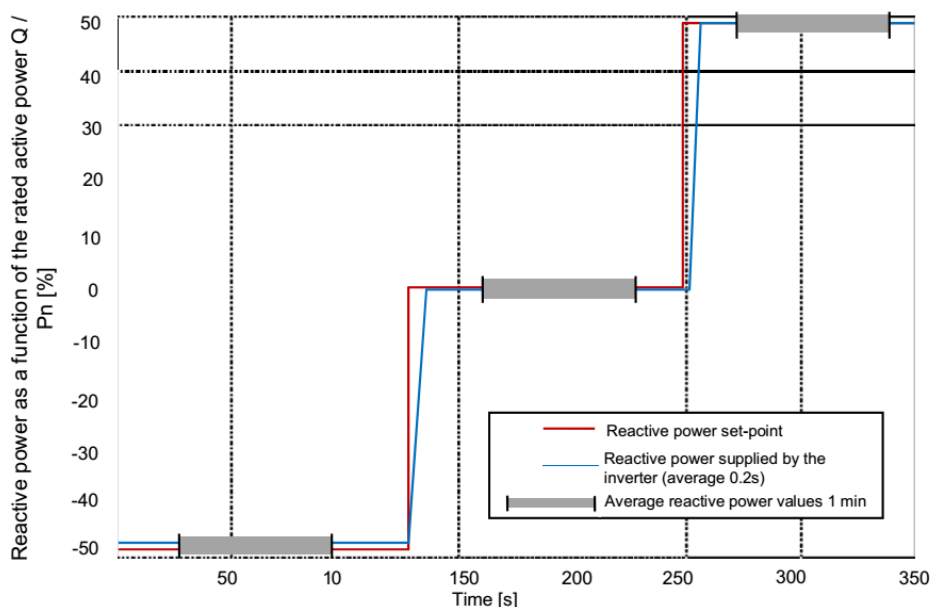

Figure 48 - Measurement of the reactive power delivered based on an external command, accuracy check

Test procedure:

- Set the DC source so that the inverter delivers about 50% of the nominal active power P_N.
- Using the methods and the control parameter established by the manufacturer, vary the reactive power supplied by the converter passing from the maximum inductive value (at least equal to Q_{min} ≤ -0.4843 P_N) directly to zero (Q = 0), and then go from zero at the maximum capacitive value (equal to Q_{max} ≥ +0.4843 P_N).
- Maintain each of the 3 limit set-points for 180 s.
- Calculate the average values of reactive power at 1 min on the basis of the values measured over a window of 200 ms at the fundamental frequency. The calculation of the value on an average of 1 min must start from the samples detected after 30 s from the instant in which the command of the new reactive power regulation set-point is sent, this is to ensure that the system has reached the steady state.

CEI 0-21			
Clause	Requirement - Test	Result - Remark	Verdict

B.1.2.4	TABLE: Response time to an assigned step level change (greater 11.08 kW systems)		P
Model	VT-6607106		
Power meter measurement data:	Sample-Rate:	0,2 s	
	Samples time:	at least 2 minutes for each power point	
P_{Emax} in %	50	100	
Maximum response time :10 s	2 s	2 s	

Test:

DC source should be set to 50% (test1) and 100% (test 2) output power

Starting with $Q=0$ then $Q_{min} \leq -0,4843 P_n$ to $Q_{max} \geq 0,4843 P_n$, and then back to $Q=0$ in doing so each point must be kept for at least 2 minute.

The total tolerance is $\Delta Q \leq \pm 5,0\%$ of P_n or $\Delta \cos\phi \leq \pm 0.01$

The maximum response time is 10s.

As for the requirements of the previous paragraph, also in this case the tests are required to inverters used in plants with a total power greater than 11.08 kW, which must also be able to implement a centralized control strategy via remote control signal, issued by the Distributor. However, the manufacturer has the right to voluntarily carry out tests even for smaller inverters.

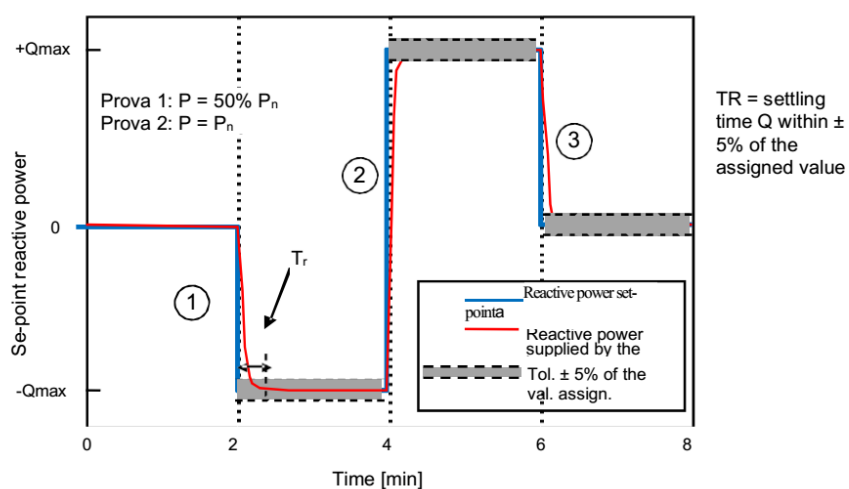
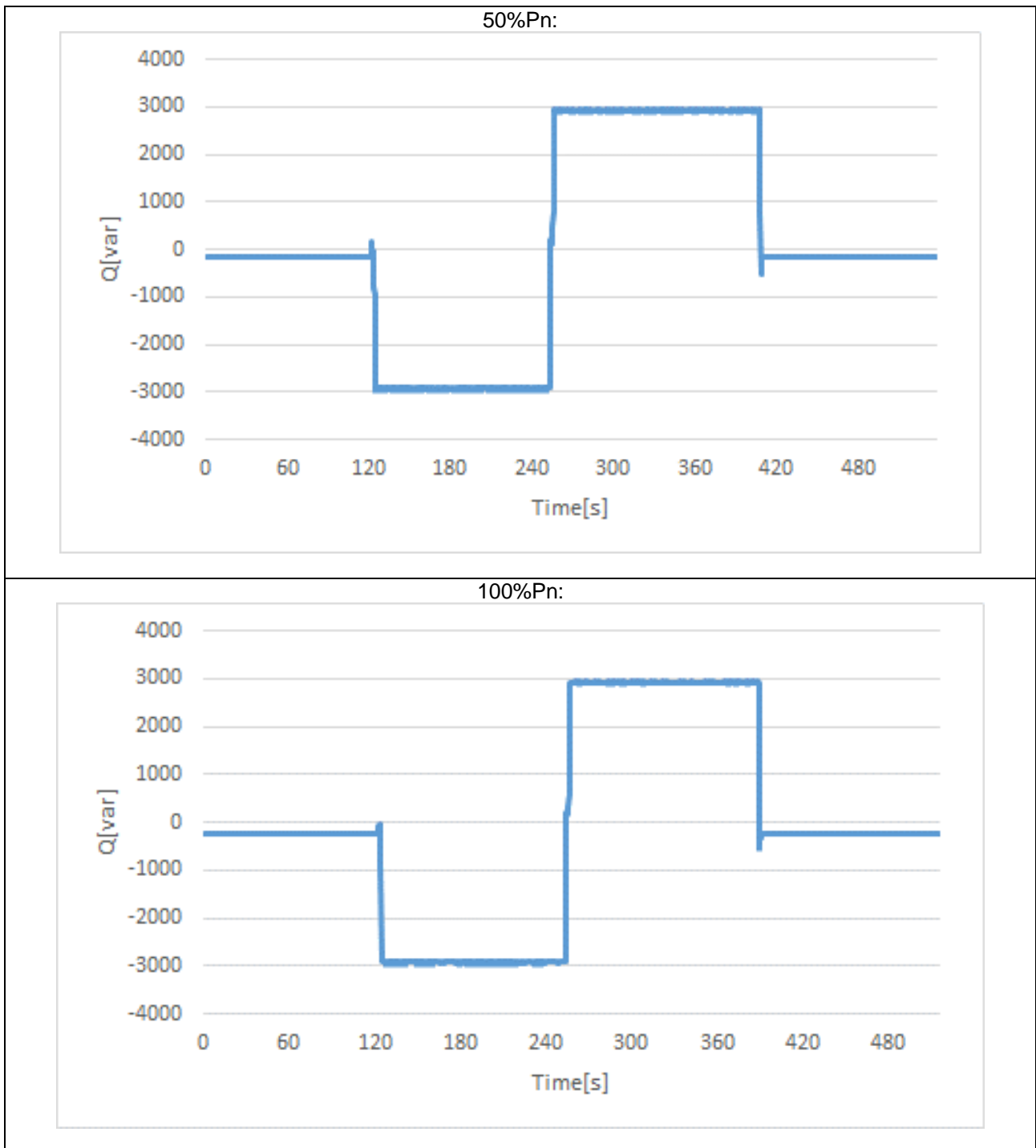

Figure 49 - Measurement of the response time to step changes of the set-point assigned for the reactive power

CEI 0-21			
Clause	Requirement - Test	Result - Remark	Verdict



CEI 0-21			
Clause	Requirement - Test	Result - Remark	Verdict

B.1.2.5	TABLE: Automatic supply of reactive power according to the characteristic curve $\cos \varphi=f(P)$	P
----------------	---	----------

Model	VT-6607106
-------	------------

Test:

Test points A-F: Set the system voltage to $1,04V_n$ (default lock-in value of the manufacture $1,05V_n$) and increases the active power from 20% $P_{E_{max}}$ in increments of 10% P_E to 60%.

Test points G-H: Set the system voltage to $1,06V_n$ increases the active power from 60% P_E to 100% $P_{E_{max}}$.

Test points J: Set the system voltage back to V_n at 100% $P_{E_{max}}$ and check that the inverter still remain in reactive power supply.

The total tolerance is $\Delta \cos \varphi \leq \pm 0.01$

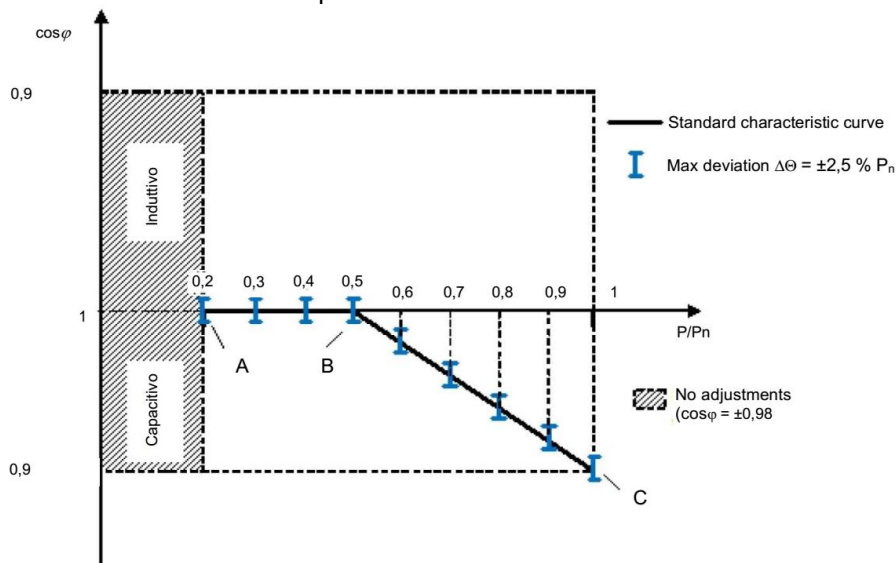

Figure 50 - Standard characteristic curve $\cos \varphi = f(P)$

Assessment criterion:

Test 1: $\cos \varphi$ accuracy $\cos \varphi (\pm 0,01)$

Test 2: $\cos \varphi$ accuracy $\cos \varphi (\pm 0,01)$

For the test to be passed, the $\cos \varphi$ setpoint from the active power must be measured at the terminals of the PGU within a settling time of 10 s.

CEI 0-21			
Clause	Requirement - Test	Result - Remark	Verdict

Model: VT-6607106								
P/P _{SMAX} [%]	P[W]	Vout[V]	Q[Var]	Cos φ _{Setpoint}	Cos φ _{measured}	ΔCosφ	Limit Δcosφ_max	Result
20	1253	104.00	157	1.00	0.992	-0.008	≤ ± 0.01	P
30	1833	104.05	159	1.00	0.996	-0.004	≤ ± 0.01	P
40	2421	104.10	156	1.00	0.998	-0.002	≤ ± 0.01	P
50	3023	104.15	154	1.00	0.998	-0.002	≤ ± 0.01	P
60	3603	104.20	135	1.00	0.999	-0.001	≤ ± 0.01	P
60	3627	106.19	-731	0.98	0.980	0.000	≤ ± 0.01	P
70	4209	106.23	-1210	0.96	0.961	0.001	≤ ± 0.01	P
80	4802	106.28	-1721	0.94	0.941	0.001	≤ ± 0.01	P
90	5406	106.32	-2284	0.92	0.921	0.001	≤ ± 0.01	P
100	5589	106.37	-2863	0.90	0.902	0.002	≤ ± 0.01	P
100	5469	102.40	-2761	0.90	0.905	0.005	≤ ± 0.01	P
100	6016	97.48	-122	1.00	0.999	-0.001	≤ ± 0.01	P

Graph reactive power production according to a characteristic curve cos(phi) = f(P)

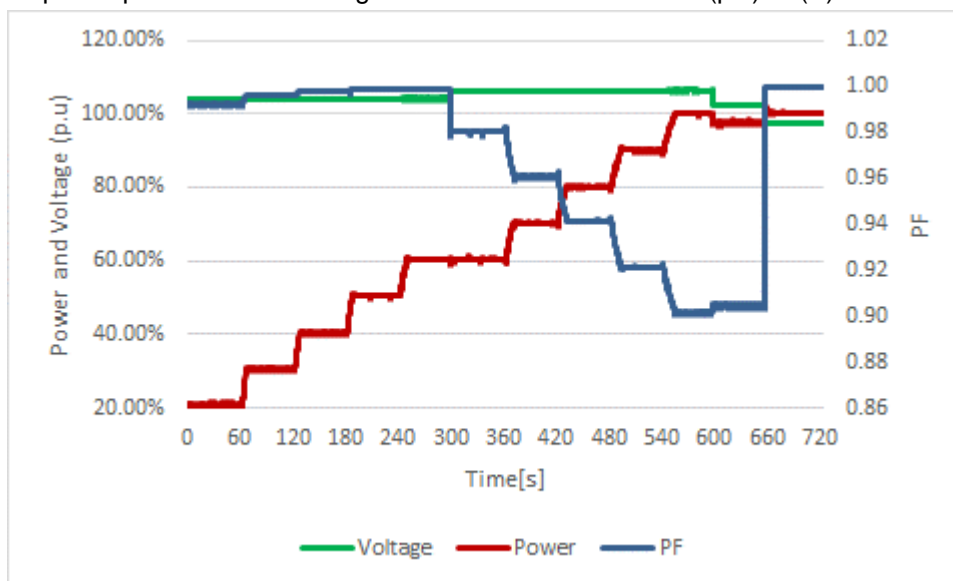

CEI 0-21			
Clause	Requirement - Test	Result - Remark	Verdict

B1.2.6	TABLE: Automatic supply of reactive power according to the characteristic curve $Q = f(V)$ (greater 11.08kW systems)	P
Over voltage & Under voltage		
Power meter measurement data:	Sample-Rate:	0.2 s
	Samples:	1000
<p>Test:</p> <p>Test points A-I: Set the system voltage to $1.07 V_n / 0.93V_n$ (default lock-in value of the manufacture $1.08 V_n / 0.92V_n$) and set up the active power to less than 20%. After stabilisation of this point increase the grid voltage from 0.93 to 0.91 and 1.08 to $1.10 V_n$ in 1V steps but hold the active power $<20\% P_E$. The active power should be now increase to 30% and then from 30% $P_{E_{max}}$ in increments of 10% P_E to 100%.</p> <p>Test points J-K: Set the system voltage to $1.10V_n$ and $0.90V_n$ and decreases the active power from 100% P_E to 10% $P_{E_{max}}$ and after at least 30s smaller than 5% $P_{E_{max}}$.</p> <p>The total tolerance is $\Delta Q \leq \pm 2.5\%$ of P_n</p> <p>The inverter must be able to delay the activation of the curve from 0s - 30s (in 1s steps / default setting: 3s)</p>		
<p style="text-align: center;">Figure 51 - Standard characteristic curves $Q = f(V)$</p>		
<p>Curve settings: $V_{1s} = 1.08V_n$; $V_{2s} = 1.1V_n$ $V_{1i} = 0.92V_n$; $V_{2i} = 0.9V_n$ (V_{1i}, V_{2i}, V_{1s} and V_{2s} must be programmable in a range 0.9-1.1V_n with steps 0.01V_n)</p>		
<p>Assessment criterion: Test 1: $\cos \varphi$ accuracy $\cos \varphi (\pm 0,01)$ Test 2: $\cos \varphi$ accuracy $\cos \varphi (\pm 0,01)$ For the test to be passed, the $\cos \varphi$ setpoint from the active power must be measured at the terminals of the PGU within a settling time of 10 s.</p>		

CEI 0-21			
Clause	Requirement - Test	Result - Remark	Verdict

B.1.2.6	TABLE: Automatic supply of reactive power according to the characteristic curve $Q = f(V)$ (greater 11.08kW systems)						P
Model	VT-6607106						
Q_{min} reactive power in accordance to standard characteristic curve $Q=f(V)$							
P/P _n [%] Set-point	Vac [V] Set-point	P/P _n [%] measured	Vac [V] measured	Q [Var] measured	Q [Var] expected	ΔQ [$\leq \pm 2.5\% P_n$]	
< 20%	1.07V _n	18.20	246.21	143	$\approx 0 (< \pm 2.5\% P_n)$	-2.39%	
< 20%	1.09V _n	18.18	250.78	148	$\approx 0 (< \pm 2.5\% P_n)$	-2.47%	
< 20% -> 30%	1.09V _n	30.37	250.77	-1183	-0.5 Q _{min} (within 10s)	-2.07%	
40%	1.09V _n	40.54	250.79	-1272	-0.5 Q _{min}	-0.59%	
50%	1.09V _n	50.70	250.79	-1276	-0.5 Q _{min}	-0.53%	
60%	1.09V _n	60.87	250.73	-1234	-0.5 Q _{min}	-1.22%	
70%	1.09V _n	71.04	250.76	-1252	-0.5 Q _{min}	-0.92%	
80%	1.09V _n	81.22	250.80	-1296	-0.5 Q _{min}	-0.19%	
90%	1.09V _n	91.39	250.72	-1266	-0.5 Q _{min}	-0.70%	
100%	1.09V _n	98.62	250.73	-1274	-0.5 Q _{min}	-0.56%	
100%	1.1 V _n	90.49	253.06	-2571	- Q _{min}	-0.74%	
100% -> 10%	1.1 V _n	9.99	253.05	-2499	- Q _{min}	-1.93%	
10% -> $\leq 5\%$	1.1 V _n	3.91	253.10	133	$\approx 0 (< \pm 5\% P_n)$	-2.21%	
Q_{max} reactive power in accordance to standard characteristic curve $Q=f(V)$							
P/P _n [%] Set-point	Vac [V] Set-point	P/P _n [%] measured	Vac [V] measured	Q [Var] measured	Q [Var] expected	ΔQ [$\leq \pm 2.5\% P_n$]	
< 20%	0.93V _n	18.29	213.97	-135	$\approx 0 (< \pm 2.5\% P_n)$	2.24%	
< 20%	0.91V _n	18.31	209.39	-135	$\approx 0 (< \pm 2.5\% P_n)$	2.25%	
< 20% - 30%	0.91V _n	30.60	209.41	1405	-0.5 Q _{max} (within 10s)	-1.63%	
40%	0.91V _n	40.76	209.38	1351	-0.5 Q _{max}	-0.73%	
50%	0.91V _n	50.94	209.34	1370	-0.5 Q _{max}	-1.04%	
60%	0.91V _n	61.13	209.32	1357	-0.5 Q _{max}	-0.83%	
70%	0.91V _n	71.30	209.35	1327	-0.5 Q _{max}	-0.33%	
80%	0.91V _n	81.50	209.32	1323	-0.5 Q _{max}	-0.26%	
90%	0.91V _n	91.41	209.36	1300	-0.5 Q _{max}	0.13%	
100%	0.91V _n	91.55	209.37	1301	-0.5 Q _{max}	0.11%	
100%	0.90V _n	89.33	207.03	2606	- Q _{max}	0.14%	
100% - 10%	0.90V _n	10.24	207.12	2613	- Q _{max}	0.04%	
10% - 5%	0.90V _n	5.06	207.06	-131	$\approx 0 (< \pm 5\% P_n)$	2.18%	
Note:							
The lock-in value is adjustable between V _n and 1.1V _n and the lock-out value between V _n and 0.9V _n in 0.01V steps.							
The inverter voltage on the AC side of the (inverter) is rated to 400V line to line.							
In reference to the circular characteristic, the inverter reduces the active output power to maintain the reactive output power.							
The under voltage measurement effects the active output power in reference to the reactive output power since the reactive output power has always priority. Therefore the inverter must lower the active output power.							

CEI 0-21			
Clause	Requirement - Test	Result - Remark	Verdict

B.1.3.1	TABLE: Automatic limitation of active power for voltage values close to 110% of the rated voltage	P
----------------	--	----------

Model	VT-6607106					
Set point		Activation threshold U_1			Deactivation threshold U_2	
U/U_n		110%			112%	
P/P_n		100%			20%	
Step	Set voltage [V/ V_n]	Voltage [V]	Measured power [W]	Measured power [%]	Limit	Result
1	1,08	248.14	5950.18	99.17%	--	P
2	1,12	258.08	1173.29	19.55%	$P < 20\%P_n$	P
3	1,08	248.04	5966.98	99.45%	--	P

The purpose of the test is to verify the automatic reduction function of the active power delivered when the voltage read at the generator terminals has a value close to 110% of V_n .

Proceed as follows:

- enable the active power reduction function $P(U)$, according to the methods indicated by the manufacturer (which must be reported in the test report);
- adjust the voltage read at the output terminals of the converter to -2% of the activation threshold declared by the manufacturer and the DC source, so that the active power delivered at the output is equal to the maximum power available for injection;
- adjust the voltage read at the output terminals of the converter to + 2% of the activation threshold declared by the manufacturer;
- the active power is measured as averages at 1 s, plotting the values obtained as a function of time;
- within 5 minutes from the instant of application of the voltage + 2% of the activation threshold declared by the manufacturer, it is verified that the active power supplied by the inverter has been reduced to a value not exceeding 20% of P_n
- adjust the voltage read at the output terminals of the converter to -2% of the activation threshold declared by the manufacturer;
- the active power is measured as averages at 1 s, plotting the values obtained as a function of time;
- verify that the active power delivered by the inverter returns to the value congruent with the power made available from the primary or simulated source.

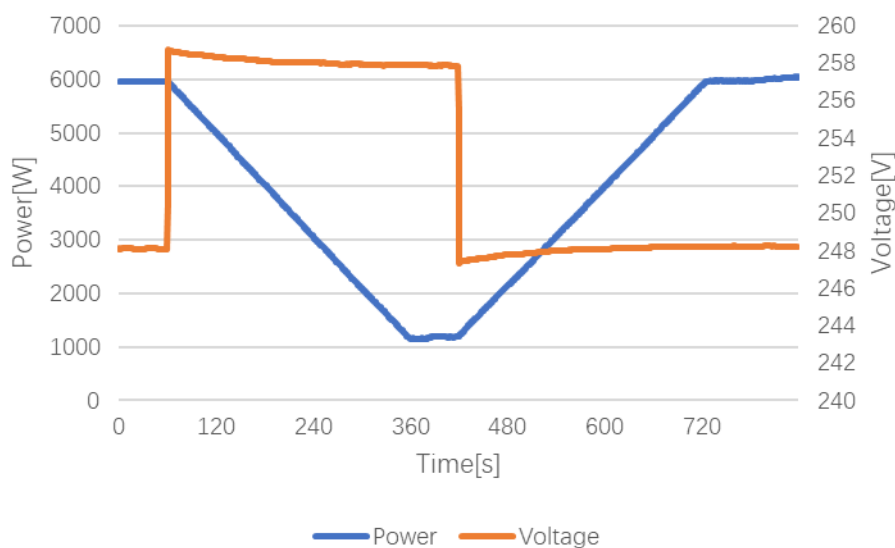

CEI 0-21			
Clause	Requirement - Test	Result - Remark	Verdict

B.1.3.2	TABLE: Adjustment of active power in the presence of over-frequency transistors on the transmission network						P
Model	VT-6607106						
Test:							
Power meter measurement data:	Sample-Rate:			0,2 s			
	Samples:			60 per frequency Point			
f [Hz] (ramps)	1) 47,51	2) 50,15	3) 50,40	4) 50,60	5) 51,49	6) 50,11	7) 50,00
file: 100% P _{E_{max}}	Sequence A						
file: 50% P _{E_{max}}	Sequence B						
Test:							
<p>The test is conducted for two powers. First, the test must start at a power 100% P_{E_{max}} ("Measurement 1"), and in a second test, for a power of 50% P_{E_{max}} ("Measurement 2"). The inverter must reduce the power and stay in this condition, until the grid stays in the limits for more than 300s. In the second test, after freezing of the momentary output power, the available active power output must be increased to a value 100% P_{E_{max}}, and after the network frequency of 50,3 Hz is fallen below, the rise of the active power gradient must be recorded.</p> <p>Perform the measurements on 7 points (the frequency value must have an uncertainty of maximum ± 10 mHz) temporally consequent to each other:</p> <ol style="list-style-type: none"> 1) f = 47.51 Hz (t₁ for sequence A, t₁ for sequence B) 2) f = 50 Hz + 0.15 Hz (t₂ for sequence A, t'₂ for sequence B) 3) f = 50 Hz + 0.40 Hz (t₃ for sequence A, t'₃ for sequence B) 4) f = 50 Hz + 0.60 Hz (t₄ for sequence A, t'₄ for sequence B) 5) f = 50 Hz + 1.49 Hz (t₅ for sequence A, t'₅ for sequence B) 6) f = 50 Hz + 0.11 Hz (t₆ for sequence A, t'₆ for sequence B) <p>Now carry out step 7). bringing the frequency back to the nominal value to verify the conditions of gradual restoration of the maximum supply (sequence A), or to 50% of the maximum power available (sequence B):</p> <ol style="list-style-type: none"> 7) f = 50 Hz (t₇ for sequence A, t'₇ for sequence B). 							

CEI 0-21			
Clause	Requirement - Test	Result - Remark	Verdict

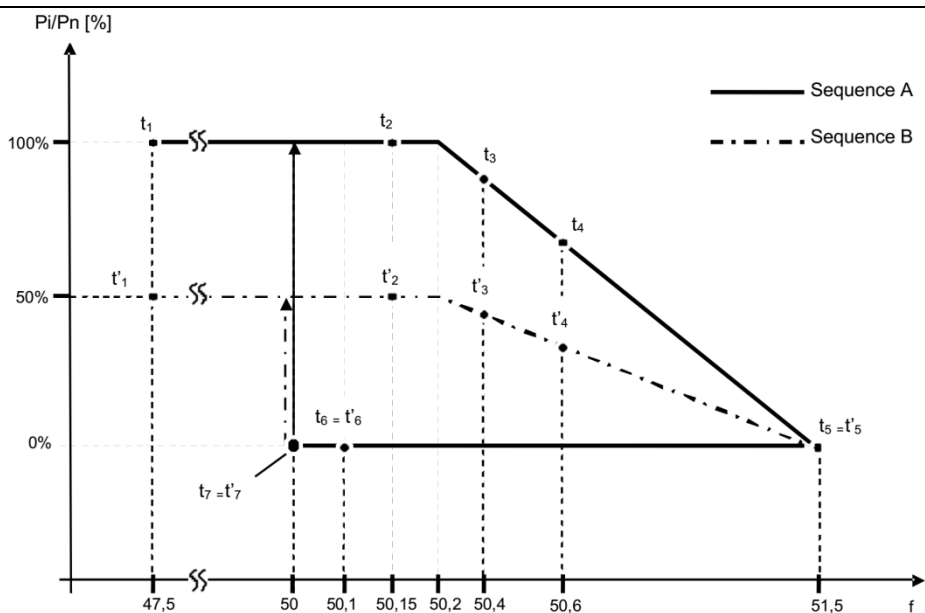
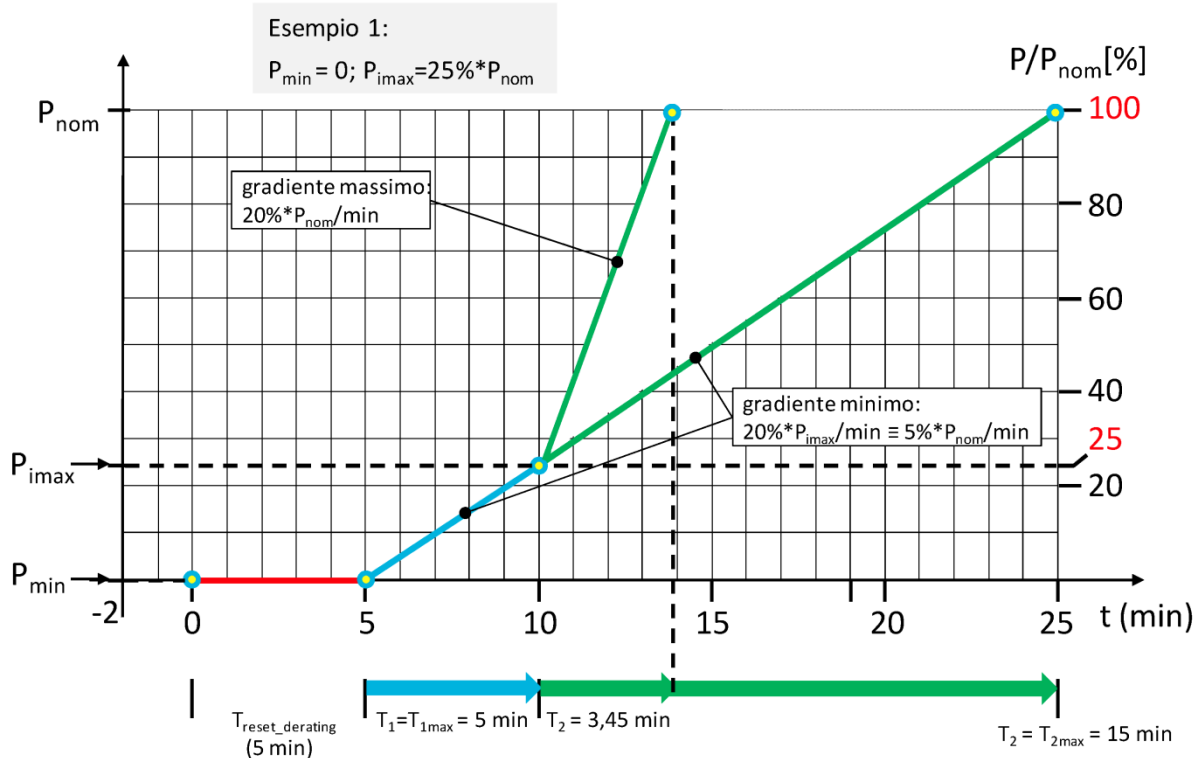

Figure 52 - Curves for limiting active power with respect to frequency

The total tolerance is $\Delta P \leq \pm 2,5\%$ of P_n

Limits of the power-up gradient



CEI 0-21			
Clause	Requirement - Test	Result - Remark	Verdict

Sequence A						
Step No.	Set output power [%]	Frequency[Hz]	Expected power value [W]	Actual power values [W]	Limits	Graph point
1	100	47.51	6000	5940	$\pm 2.5\% P_n$	t ₁
2	100	50.15	6000	6002	$\pm 2.5\% P_n$	t ₂
3	100	50.40	5077	5067	$\pm 2.5\% P_n$	t ₃
4	100	50.60	4154	4153	$\pm 2.5\% P_n$	t ₄
5	100	51.49	46	45	$\pm 2.5\% P_n$	t ₅
6	100	50.10	46	43	$\pm 2.5\% P_n$	t ₆
7	100	50.00	6000	5993	P _n	t ₇

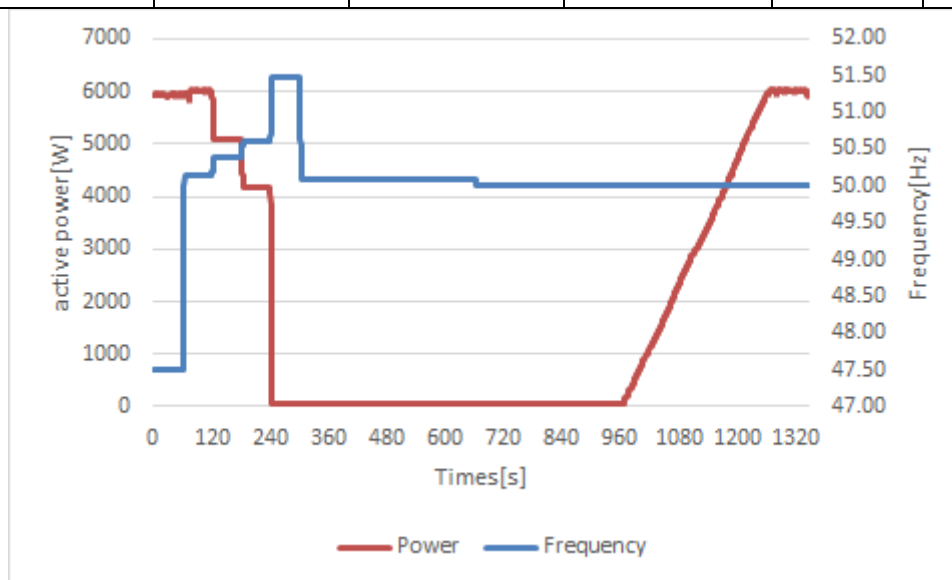

CEI 0-21			
Clause	Requirement - Test	Result - Remark	Verdict

Sequence B						
Step No.	Set output power [%]	Frequency[Hz]	Expected power value [W]	Actual power values [W]	Limits	Graph point
1	50	47.51	3000	3062	$\pm 2.5\% P_n$	t ₁
2	50	50.15	3000	3065	$\pm 2.5\% P_n$	t ₂
3	50	50.40	2538	2537	$\pm 2.5\% P_n$	t ₃
4	50	50.60	2077	2032	$\pm 2.5\% P_n$	t ₄
5	50	51.49	23	29	$\pm 2.5\% P_n$	t ₅
6	50	50.10	23	28	$\pm 2.5\% P_n$	t ₆
7	50	50.00	3000	3003	50% P _n	t ₇

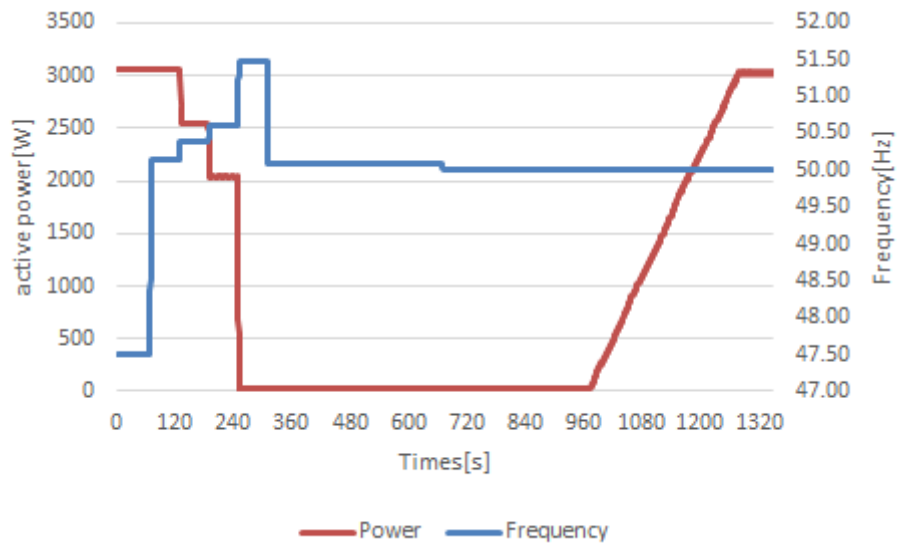

CEI 0-21			
Clause	Requirement - Test	Result - Remark	Verdict

B.1.3.3	TABLE: Verification of the operating range in voltage and frequency	P
----------------	--	----------

Model	VT-6607106					
-------	------------	--	--	--	--	--

Test No.	Voltage (V)	Frequency (Hz)	P (W)	Cos ϕ	Time (s)	Limit (%P _n)
Test 1	253.26	51.50	6080	0.998	>5min	± 5
Test 2	195.74	50.00	5164	0.998	>5min	± 15

Test 1: $V = 110 \% * V_n$; $f = 51,5 \text{ Hz}$; $P = 100 \%P_n$; $\text{Cos } \phi = 1$ (Duration: at least 5 minutes)

Test 2: $V = 85 \% * V_n$; $f = 50,0 \text{ Hz}$; $P = 100 \%P_n$; $\text{Cos } \phi = 1$

Test 1 and 2 have a duration of at least 5 minutes. In Test 2, operation at reduced power is allowed, equal to the maximum deliverable when the maximum output current limit has been reached ($P \geq 85\% P_n$).

To allow the tests to be carried out, the restrictive frequency thresholds must be disabled.

During the tests it is necessary to disable the automatic regulation in power reduction in case of over-frequency.

The frequency, voltage and active power measured at the generator output terminals must be recorded at a rate of at least 1 sample per second. The delivered power must remain stable within a limit of $\pm 5\%P_n$.

Test 1

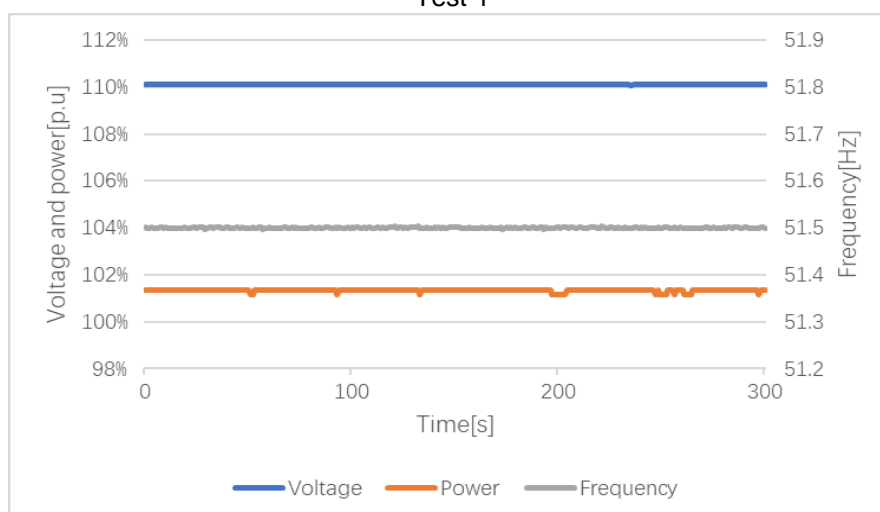

Test 2

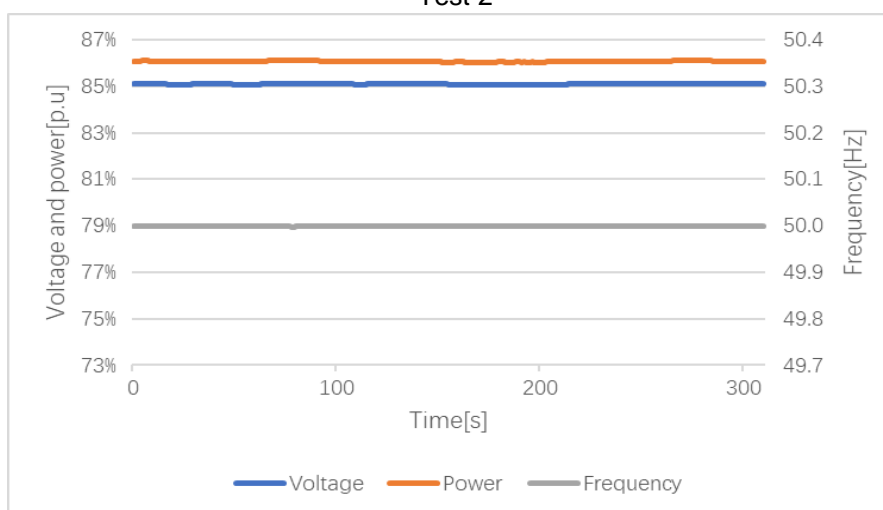

CEI 0-21			
Clause	Requirement - Test	Result - Remark	Verdict

B.1.3.3.1	TABLE: Reduction of active power in the presence of transient under-frequency on transmission network						P
Model:	VT-6607106						
5-min mean value	50.0 Hz	49.5 Hz	49.0 Hz	48.5 Hz	48.0 Hz	47.5 Hz	
Frequency [Hz]:	50.00	49.50	49.00	48.50	48.00	47.50	
Active power [W]:	6014	6017	6018	6016	6017	6017	
<p>Test:</p> <p>The test must be carried out at 100% P_n.</p> <p>Measurements are carried out at the following operating points:</p> <ul style="list-style-type: none"> -Connect the object under test according to the instructions provided by the manufacturer. -Set all the parameters of the simulated network to the respective values of normal exercise. -Bring all the parameters of the object under test to the respective values of normal performance, such that the out power of the inverter is equal to the maximum deliverable power. -Implement measures of active power on 6 points of time from each other on the basis of 50 Hz, and by reducing the frequency of 0.5 Hz with a step up to the minimum value of 47.5 Hz. <p>The each operating point shall be maintained for at least 5 min.</p> <p>Assessment criterion:</p> <p>The test is regarded as passed if:</p> <p>the results should be presented in a table, and on the basis they must extrapolate the trend on a graph that must be greater than the threshold identified by continuous tract of fig. 12a contained in the 8.4.4.</p> <ul style="list-style-type: none"> • the power reduction in point c) is less or equal to the allowed power reduction according to 8.4.4. <p>The power reduction in point c) is less or equal to the power reduction of 10 % P_M per 1 Hz drop.</p>							
<p style="text-align: center;">Maximum allowable power reduction in case of under-frequency</p>							

CEI 0-21			
Clause	Requirement - Test	Result - Remark	Verdict

B.1.3.4	TABLE: Limitation of active power by external control from the distributor	P
----------------	---	----------

Model	VT-6607106			
Set point P [P/P_n]	Set point P [W]	P measured [W]	Deviation (%)	Limit ($\%P_n$)
100	6000	6026	-0.43%	--
90	5400	5478	-1.30%	± 2.5
80	4800	4870	-1.16%	± 2.5
70	4200	4260	-1.00%	± 2.5
60	3600	3651	-0.85%	± 2.5
50	3000	3043	-0.71%	± 2.5
40	2400	2433	-0.56%	± 2.5
30	1800	1823	-0.39%	± 2.5
20	1200	1214	-0.23%	± 2.5
10	600	605	-0.08%	± 2.5

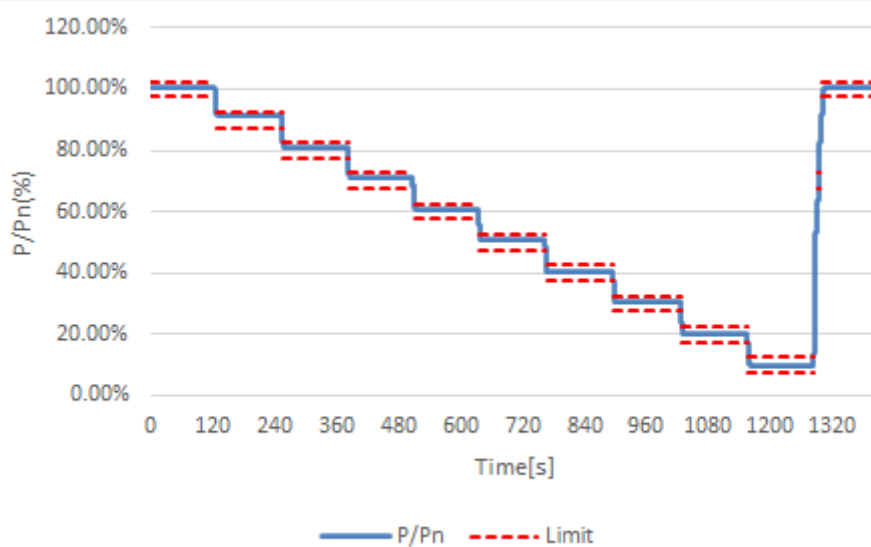
**Test:**

The setpoint signal must be reduced from 100% to 10% $P_{E_{max}}$:

For adjustable PGUs in increments of 10% $P_{E_{max}}$. 1 minute must elapse after every change to the setpoint setting so that the PGU can settle at the new setpoint. Then the active power of the PGU must be measured as a 1-min mean value.

Assessment criterion:

a) for adjustable PGUs:

- no network disconnection above 12,5% P_n
- the active power value does not exceed the setpoint by more than 2,5% P_n
- the setting time determined this way is ≤ 1 min

Note:

CEI 0-21			
Clause	Requirement - Test	Result - Remark	Verdict

B.1.4.1	TABLE: Checking the DC component output			P
Model	VT-6607106			
Power Level	(33 ± 5)%	(66 ± 5)%	(100 ± 5)%	
Ambient				
Total output Power (W)	2011	4005	6032	
Output Vrms	230.27	230.27	230.68	
Output Arms	8.76	17.41	26.16	
Cos φ	0.999	0.999	0.999	
L1 DC Component (A)	0.006	0.006	0.005	
L2 DC Component (A)	-	-	-	
L3 DC Component (A)	-	-	-	
L1 DC Component (% I _r)	0.021%	0.023%	0.019%	
L2 DC Component (% I _r)	-	-	-	
L3 DC Component (% I _r)	-	-	-	
Minimum ambient rating or 20°C				
Total output Power (W)	2010	4005	6035	
Output Vrms	230.28	230.27	230.69	
Output Arms	8.76	17.40	26.18	
Cos φ	0.999	0.999	0.999	
L1 DC Component (A)	0.005	0.005	0.005	
L2 DC Component (A)	-	-	-	
L3 DC Component (A)	-	-	-	
L1 DC Component (% I _r)	0.019%	0.020%	0.018%	
L2 DC Component (% I _r)	-	-	-	
L3 DC Component (% I _r)	-	-	-	
Maximum ambient rating or 60°C				
Total output Power (W)	2010	4000	6021	
Output Vrms	230.28	230.27	230.69	
Output Arms	8.76	17.38	26.11	
Cos φ	0.999	0.999	0.999	
L1 DC Component (A)	0.005	0.005	0.005	
L2 DC Component (A)	-	-	-	
L3 DC Component (A)	-	-	-	
L1 DC Component (% I _r)	0.020%	0.020%	0.021%	
L2 DC Component (% I _r)	-	-	-	
L3 DC Component (% I _r)	-	-	-	

CEI 0-21			
Clause	Requirement - Test	Result - Remark	Verdict

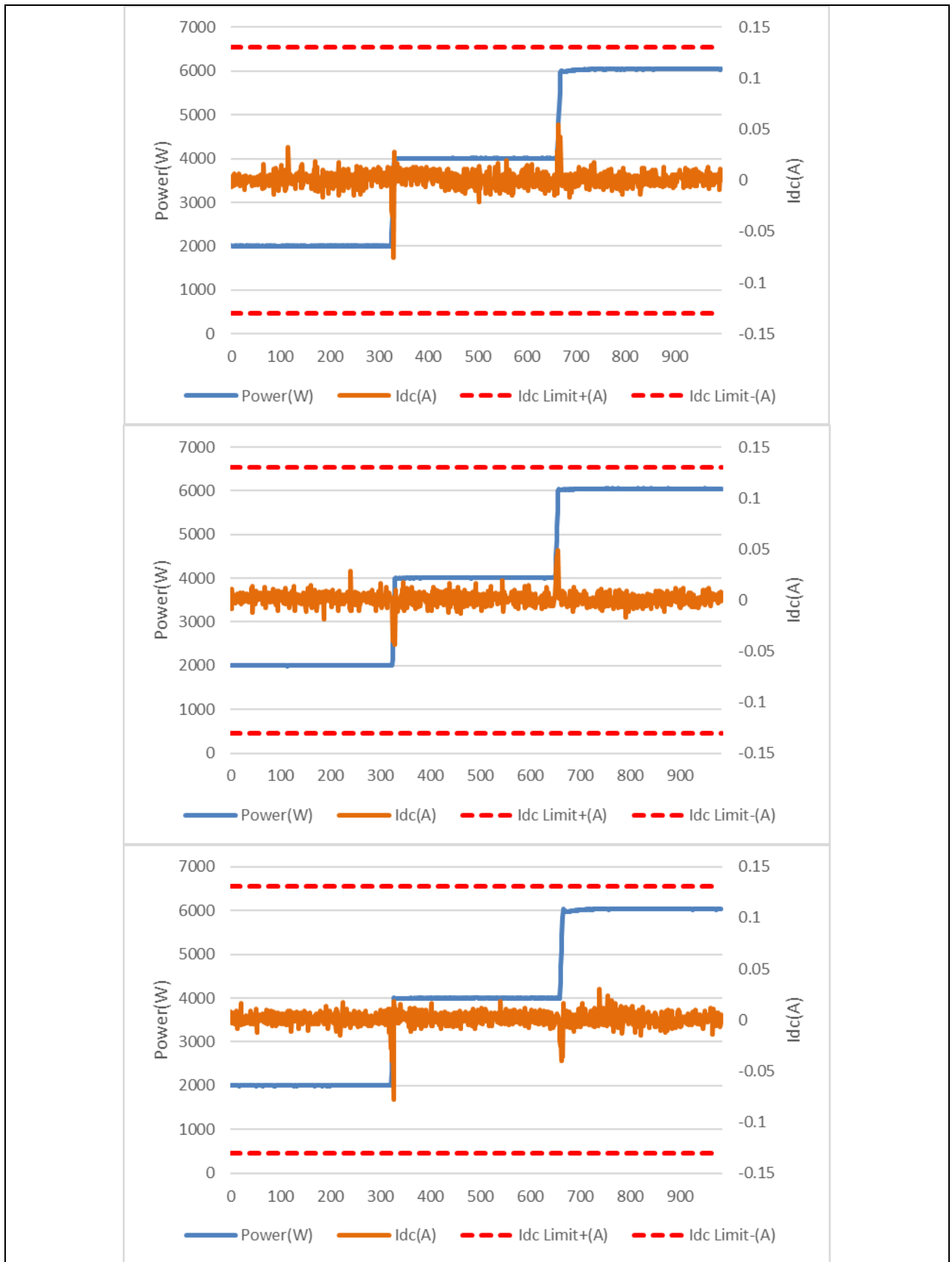

CEI 0-21			
Clause	Requirement - Test	Result - Remark	Verdict

B.1.4.1	TABLE: Checking the DC component output			P
Model	VT-6607100			
Power Level	(33 ± 5)%	(66 ± 5)%	(100 ± 5)%	
Ambient				
Total output Power (W)	335	672	1019	
Output Vrms	229.87	229.86	230.07	
Output Arms	1.47	2.93	4.44	
Cos φ	0.997	0.998	0.999	
L1 DC Component (A)	0.002	0.002	0.002	
L2 DC Component (A)	-	-	-	
L3 DC Component (A)	-	-	-	
L1 DC Component (% I _r)	0.042%	0.043%	0.040%	
L2 DC Component (% I _r)	-	-	-	
L3 DC Component (% I _r)	-	-	-	
Minimum ambient rating or 20°C				
Total output Power (W)	335	673	1019	
Output Vrms	230.07	230.06	230.27	
Output Arms	1.46	2.93	4.43	
Cos φ	0.998	0.998	0.999	
L1 DC Component (A)	0.002	0.002	0.002	
L2 DC Component (A)	-	-	-	
L3 DC Component (A)	-	-	-	
L1 DC Component (% I _r)	0.044%	0.048%	0.042%	
L2 DC Component (% I _r)	-	-	-	
L3 DC Component (% I _r)	-	-	-	
Maximum ambient rating or 60°C				
Total output Power (W)	333	670	1016	
Output Vrms	230.07	230.07	230.27	
Output Arms	1.46	2.92	4.42	
Cos φ	0.998	0.998	0.999	
L1 DC Component (A)	0.002	0.002	0.002	
L2 DC Component (A)	-	-	-	
L3 DC Component (A)	-	-	-	
L1 DC Component (% I _r)	0.044%	0.048%	0.042%	
L2 DC Component (% I _r)	-	-	-	
L3 DC Component (% I _r)	-	-	-	

CEI 0-21			
Clause	Requirement - Test	Result - Remark	Verdict

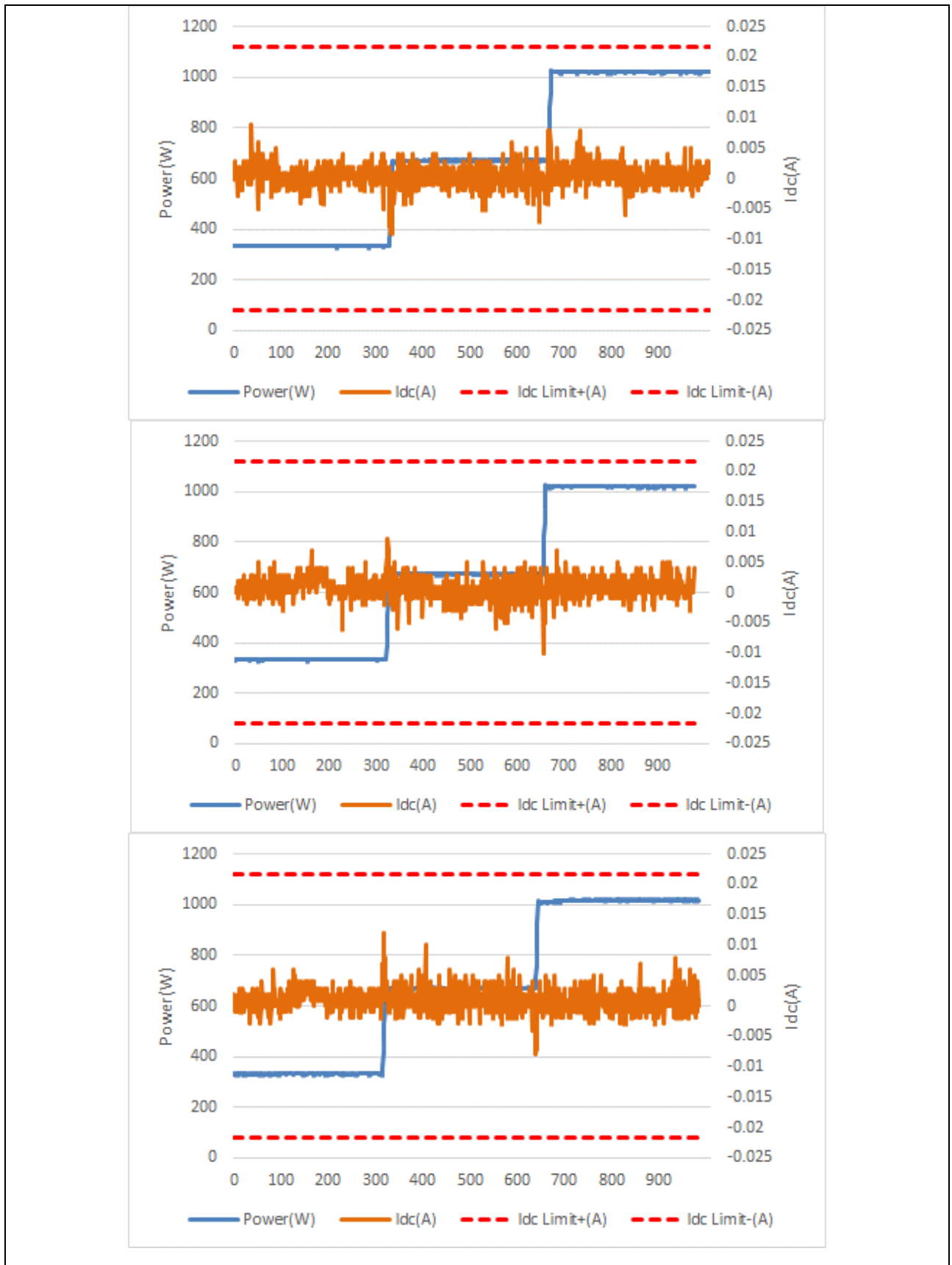

CEI 0-21			
Clause	Requirement - Test	Result - Remark	Verdict

B.1.4.2	TABLE: Checking the protection against DC injection				P
Model	VT-6607106				
Ambient					
Actual Power	Limits	Measurement:(mA)	Limiting value: (mA)	Disconnection time:(ms)	
I_{dc} = 0,5% of I_{nom}					
33%	+0,5%I _{nom} /1s	131.0	130.4	992.4	
66%	+0,5%I _{nom} /1s	134.4	130.4	994.2	
100%	+0,5%I _{nom} /1s	134.5	130.4	980.0	
I_{dc} = 1A					
33%	+1A I _{dc} /200ms	1018	1000	194.4	
66%	+1A I _{dc} /200ms	1020	1000	188.9	
100%	+1A I _{dc} /200ms	1019	1000	194.6	
Model	VT-6607100				
Actual Power	Limits	Measurement:(mA)	Limiting value:(mA)	Disconnection time:(ms)	
I_{dc} = 0,5% of I_{nom}					
33%	+0,5%I _{nom} /1s	22.03	21.7	985.0	
66%	+0,5%I _{nom} /1s	22.01	21.7	983.4	
100%	+0,5%I _{nom} /1s	22.04	21.7	990.4	
I_{dc} = 1A					
33%	+1A I _{dc} /200ms	1006	1000	183.6	
66%	+1A I _{dc} /200ms	1019	1000	195.9	
100%	+1A I _{dc} /200ms	1018	1000	187.6	
Note: The internal temperature of the EUT must be stabilized.					

CEI 0-21			
Clause	Requirement - Test	Result - Remark	Verdict

B.1.4.2	TABLE: Checking the protection against DC injection				P
Model:	VT-6607106				
Minimum ambient rating or 20°C					
Actual Power	Limits	Measurement:(mA)	Limiting value: (mA)	Disconnection time:(ms)	
I_{dc} = 0,5% of I_{nom}					
33%	+0,5%I _{nom} /1s	134.3	130.4	997.4	
66%	+0,5%I _{nom} /1s	134.4	130.4	985.6	
100%	+0,5%I _{nom} /1s	134.5	130.4	998.1	
I_{dc} = 1A					
33%	+1A I _{dc} /200ms	1020	1000	193.2	
66%	+1A I _{dc} /200ms	1019	1000	198.1	
100%	+1A I _{dc} /200ms	1020	1000	185.4	
Model:	VT-6607100				
Actual Power	Limits	Measurement:(mA)	Limiting value: (mA)	Disconnection time:(ms)	
I_{dc} = 0,5% of I_{nom}					
33%	+0,5%I _{nom} /1s	22.06	21.74	992.7	
66%	+0,5%I _{nom} /1s	22.01	21.74	987.6	
100%	+0,5%I _{nom} /1s	22.07	21.74	989.6	
I_{dc} = 1A					
33%	+1A I _{dc} /200ms	1007	1000	188.6	
66%	+1A I _{dc} /200ms	1016	1000	189.9	
100%	+1A I _{dc} /200ms	1017	1000	193.0	
Note: The internal temperature of the EUT must be stabilized.					

CEI 0-21			
Clause	Requirement - Test	Result - Remark	Verdict

B.1.4.2	TABLE: Checking the protection against DC injection			P
Model:	VT-6607106			
Maximum ambient rating or 60°C				
Actual Power	Limits	Measurement:(mA)	Limiting value:(mA)	Disconnection time:(ms)
I_{dc} = 0,5% of I_{nom}				
33%	+0,5%I _{nom} /1s	134.1	130.4	996.2
66%	+0,5%I _{nom} /1s	134.6	130.4	985.2
100%	+0,5%I _{nom} /1s	134.5	130.4	985.3
I_{dc} = 1A				
33%	+1A I _{dc} /200ms	1019	1000	187.4
66%	+1A I _{dc} /200ms	1019	1000	184.3
100%	+1A I _{dc} /200ms	1018	1000	194.6
Model:	VT-6607100			
Actual Power	Limits	Measurement:(mA)	Limiting value:(mA)	Disconnection time:(ms)
I_{dc} = 0,5% of I_{nom}				
33%	+0,5%I _{nom} /1s	22.05	21.74	991.2
66%	+0,5%I _{nom} /1s	22.05	21.74	989.4
100%	+0,5%I _{nom} /1s	22.05	21.74	997.6
I_{dc} = 1A				
33%	+1A I _{dc} /200ms	1005	1000	182.1
66%	+1A I _{dc} /200ms	1020	1000	188.7
100%	+1A I _{dc} /200ms	1018	1000	190.4
Note: The internal temperature of the EUT must be stabilized.				

CEI 0-21			
Clause	Requirement - Test	Result - Remark	Verdict

B.1.5	TABLE: Verification of insensitivity to voltage dips (UVRT capability) [greater 11.08kW systems]	P	
Model	VT-6607106		

The purpose of these tests is to ensure that the converter, when used in systems with total capacity greater than 11.08 kW, is insensitive to voltage dips according to the time-amplitude profile shown in the diagram. In particular, the tests must verify that the following functional requirements are met:

- the generator must not disconnect from the grid in the white area above and along the points of the UVRT (V-t) characteristic indicated in Figure 29, where V is the phase-to-phase voltage at the connection point. Supply of active and reactive power prior to the occurrence of the fault can be temporarily interrupted in this area.
- in the area below (grey) the generator can disconnect from the grid.
- within 400 ms from restoring network voltage to within the range of +10% and -15% of nominal voltage, the generator must return to supplying active and reactive power to the network as before the fault, with a maximum tolerance of $\pm 10\%$ of the nominal voltage of the generator. If voltage returns but remains in the range between 85% and 90%, power distribution may be reduced in relation to the generator limits of output power.

Verification of compliance with the requirements of immunity to voltage sags are carried out according to the test sequences shown in Table 31, to be carried out with the generator running respectively:

- between 10% and 30% of the rated power;
- and above 90% of the rated power.

Table 12 - Parameters relating to **Figure 29** for the fault-ride-through capability of power park modules over 11.08 kW

U _{ret}	0,05 [p.u.]	T _{clear}	0,2 s
U _{clear}	0,15 [p.u.]	T _{rec1}	0,2 s
U _{rec1}	0,15 [p.u.]	T _{rec2}	0,2 s
U _{rec2}	0,85 [p.u.]	T _{rec3}	1,5 s

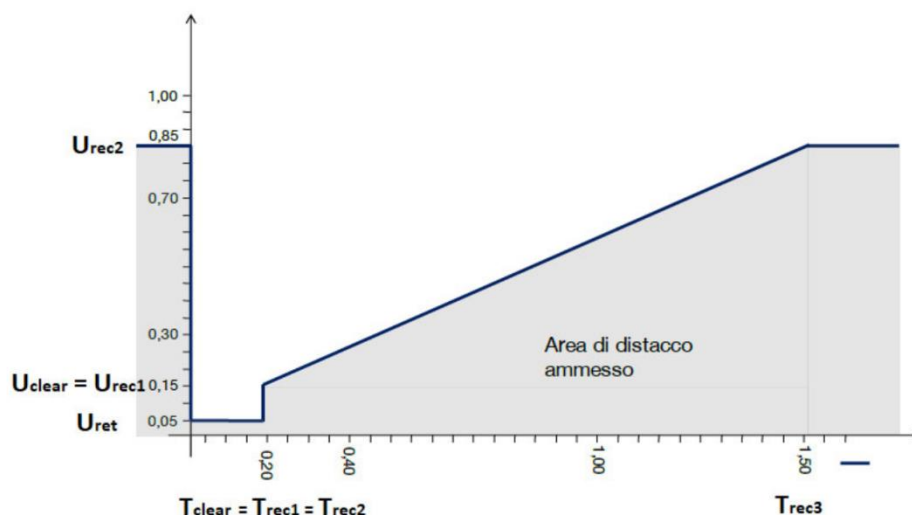
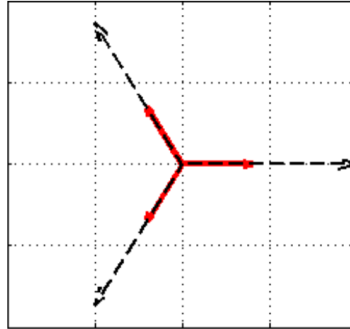

Figure 29 - Fault-ride-through profile of power park modules over 11.08 kW

CEI 0-21			
Clause	Requirement - Test	Result - Remark	Verdict

Test sequence:

- 1) three-phase symmetrical fault (**Table 31**, Tests N.1s, N.2s, N.3s and N4s)



- 2) two-phase asymmetric fault (**Table 31**, Tests N.1a, N2a, N.3a and N.4a)

Failure in MV, which causes a variation in LV not only of amplitude but also of the phase relationship of the voltages (the case considered involves the presence of a transformer Dy in the secondary substation).

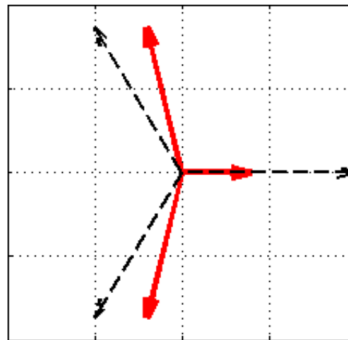



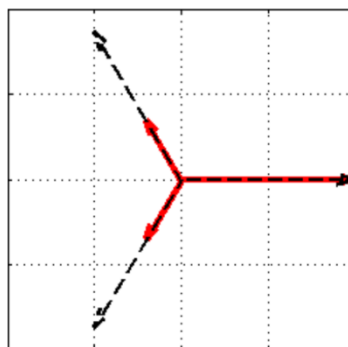







- 3) LV two-phase asymmetric fault (**Table 31**, Tests No. 5 and No. 6)



CEI 0-21			
Clause	Requirement - Test	Result - Remark	Verdict

Requirement of LVRT test:**Table 31 - Test sequences to verify immunity to temporary voltage dips. The amplitude, duration and shape relate to no-load test conditions**

List of tests	Residual amplitude of phase-to-phase voltage V/V_{nom}	Drop duration limit [ms]	Power re-supply time after restoring network [ms]	Shape (*)
1s – three-phase symmetrical fault	$0,10 \pm 0,05 (V_1/V_n)$	200 ± 20	400	
1a – two-phase asymmetric failure	$0,10 \pm 0,05 (V_1/V_n)$	200 ± 20	400	
2s – three-phase symmetrical fault	$0,25 \pm 0,05 (V_2/V_n)$	400 ± 20	400	
2a – two-phase asymmetric failure	$0,25 \pm 0,05 (V_2/V_n)$	400 ± 20	400	
3s – three-phase asymmetrical fault	$0,50 \pm 0,05 (V_3/V_n)$	850 ± 20	400	
3a – two-phase asymmetric failure	$0,50 \pm 0,05 (V_3/V_n)$	850 ± 20	400	
4s – three-phase asymmetrical fault	$0,75 \pm 0,05 (V_4/V_n)$	1300 ± 20	400	
4a – two-phase asymmetric failure	$0,75 \pm 0,05 (V_4/V_n)$	1300 ± 20	400	
5 – LV two-phase asymmetrical fault	$0,10 \pm 0,05 (V_5/V_n)$	200 ± 20	400	
6 – LV two-phase asymmetrical fault	$0,50 \pm 0,05 (V_6/V_n)$	850 ± 20	400	

Test No.	V/V_{nom}	Phase-to-earth voltages			Phase angles		
		$U_1/U_{1,nom}$	$U_2/U_{2,nom}$	$U_3/U_{3,nom}$	φ_{U1}	φ_{U2}	φ_{U3}
1s	$0,10 \pm 0,05$	$0,10 \pm 0,05$	$0,10 \pm 0,05$	$0,10 \pm 0,05$	0°	-120°	120°
1a	$0,10 \pm 0,05$	$0,87 \pm 0,05$	$0,87 \pm 0,05$	$0,10 \pm 0,05$	27°	-147°	120°
2s	$0,25 \pm 0,05$	$0,25 \pm 0,05$	$0,25 \pm 0,05$	$0,25 \pm 0,05$	0°	-120°	120°
2a	$0,25 \pm 0,05$	$0,88 \pm 0,05$	$0,88 \pm 0,05$	$0,25 \pm 0,05$	22°	-142°	120°
3s	$0,50 \pm 0,05$	$0,50 \pm 0,05$	$0,50 \pm 0,05$	$0,50 \pm 0,05$	0°	-120°	120°
3a	$0,50 \pm 0,05$	$0,90 \pm 0,05$	$0,90 \pm 0,05$	$0,50 \pm 0,05$	14°	-134°	120°
4s	$0,75 \pm 0,05$	$0,75 \pm 0,05$	$0,75 \pm 0,05$	$0,75 \pm 0,05$	0°	-120°	120°
4a	$0,75 \pm 0,05$	$0,94 \pm 0,05$	$0,94 \pm 0,05$	$0,75 \pm 0,05$	7°	-127°	120°
5	$0,10 \pm 0,05$	1	$0,10 \pm 0,05$	$0,10 \pm 0,05$	0°	-120°	120°
6	$0,50 \pm 0,05$	1	$0,50 \pm 0,05$	$0,50 \pm 0,05$	0°	-120°	120°
normal condition	1	1	1	1	0°	-120°	120°

(*) Regardless of the method used to simulate the transients (simulator or impedance network), the falling and rising edges of the voltage must have a duration of less than 10 ms.

CEI 0-21			
Clause	Requirement - Test	Result - Remark	Verdict

Graph of LVRT and OVRT test:				
List of tests	Residual amplitude of phase-to-phase voltage V/V_{nom}	Drop duration limit [ms]	Measured drop duration [ms]	Duration of restoring network [ms]
1s – three-phase symmetrical fault (P = 0,1 - 0,3)	$0,10 \pm 0,05 (V_1/V_n)$	200 +20	211	151
1s – three-phase symmetrical fault (P > 0,9)	$0,10 \pm 0,05 (V_1/V_n)$	200 +20	211	168
1a – two-phase asymmetrical fault (P = 0,1 - 0,3)	$0,10 \pm 0,05 (V_1/V_n)$	200 +20	211	124
1a – two-phase asymmetrical fault (P > 0,9)	$0,10 \pm 0,05 (V_1/V_n)$	200 +20	211	119
2s – three-phase symmetrical fault (P = 0,1 - 0,3)	$0,25 \pm 0,05 (V_2/V_n)$	400 +20	407	162
2s – three-phase symmetrical fault (P > 0,9)	$0,25 \pm 0,05 (V_2/V_n)$	400 +20	407	157
2a – three-phase symmetrical fault (P = 0,1 - 0,3)	$0,25 \pm 0,05 (V_2/V_n)$	400 +20	411	173
2a – three-phase symmetrical fault (P > 0,9)	$0,25 \pm 0,05 (V_2/V_n)$	400 +20	411	141
3s – three-phase symmetrical fault (P = 0,1 - 0,3)	$0,50 \pm 0,05 (V_3/V_n)$	850 ± 20	860	151
3s – three-phase symmetrical fault (P > 0,9)	$0,50 \pm 0,05 (V_3/V_n)$	850 ± 20	860	160
3a – two-phase asymmetrical fault (P = 0,1 - 0,3)	$0,50 \pm 0,05 (V_3/V_n)$	850 ± 20	860	176
3a – two-phase asymmetrical fault (P > 0,9)	$0,50 \pm 0,05 (V_3/V_n)$	850 ± 20	860	144
4s – three-phase symmetrical fault (P = 0,1 - 0,3)	$0,75 \pm 0,05 (V_4/V_n)$	1300 ± 20	1312	151
4s – three-phase symmetrical fault (P > 0,9)	$0,75 \pm 0,05 (V_4/V_n)$	1300 ± 20	1312	156
4a – two-phase asymmetrical fault (P = 0,1 - 0,3)	$0,75 \pm 0,05 (V_4/V_n)$	1300 ± 20	1312	159
4a – two-phase asymmetrical fault (P > 0,9)	$0,75 \pm 0,05 (V_4/V_n)$	1300 ± 20	1312	119
5 – LV two-phase asymmetrical fault (P = 0,1 - 0,3)	$0,10 \pm 0,05 (V_5/V_n)$	200 +20	210	0
5 – LV two-phase asymmetrical fault (P > 0,9)	$0,10 \pm 0,05 (V_5/V_n)$	200 +20	210	0
6 – LV two-phase asymmetrical fault (P = 0,1 - 0,3)	$0,50 \pm 0,05 (V_6/V_n)$	400 +20	851	0
6 – LV two-phase asymmetrical fault (P > 0,9)	$0,50 \pm 0,05 (V_6/V_n)$	400 +20	851	0
7 – HV three-phase symmetrical fault (P = 0,1 - 0,3)	$1,20 \pm 0,05 (V_7/V_n)$	500 +20	511	152
7 – HV three-phase symmetrical fault (P > 0,9)	$1,20 \pm 0,05 (V_7/V_n)$	500 +20	511	117
8 – HV three-phase symmetrical fault (P = 0,1 - 0,3)	$1,25 \pm 0,05 (V_8/V_n)$	100 +20	110	140
8 – HV three-phase symmetrical fault (P > 0,9)	$1,25 \pm 0,05 (V_8/V_n)$	100 +20	110	132
Note:				
(*) Regardless of the method used to simulate transients (simulator or impedance network), the rise and fall time of the voltage must be less than 10 ms				
The interface protection shall be disabled or adjusted to avoid spurious tripping during testing.				
The test conditions are performed as worst case conditions. The inverter feeds maximal active and reactive power during the complete test.				

CEI 0-21			
Clause	Requirement - Test	Result - Remark	Verdict

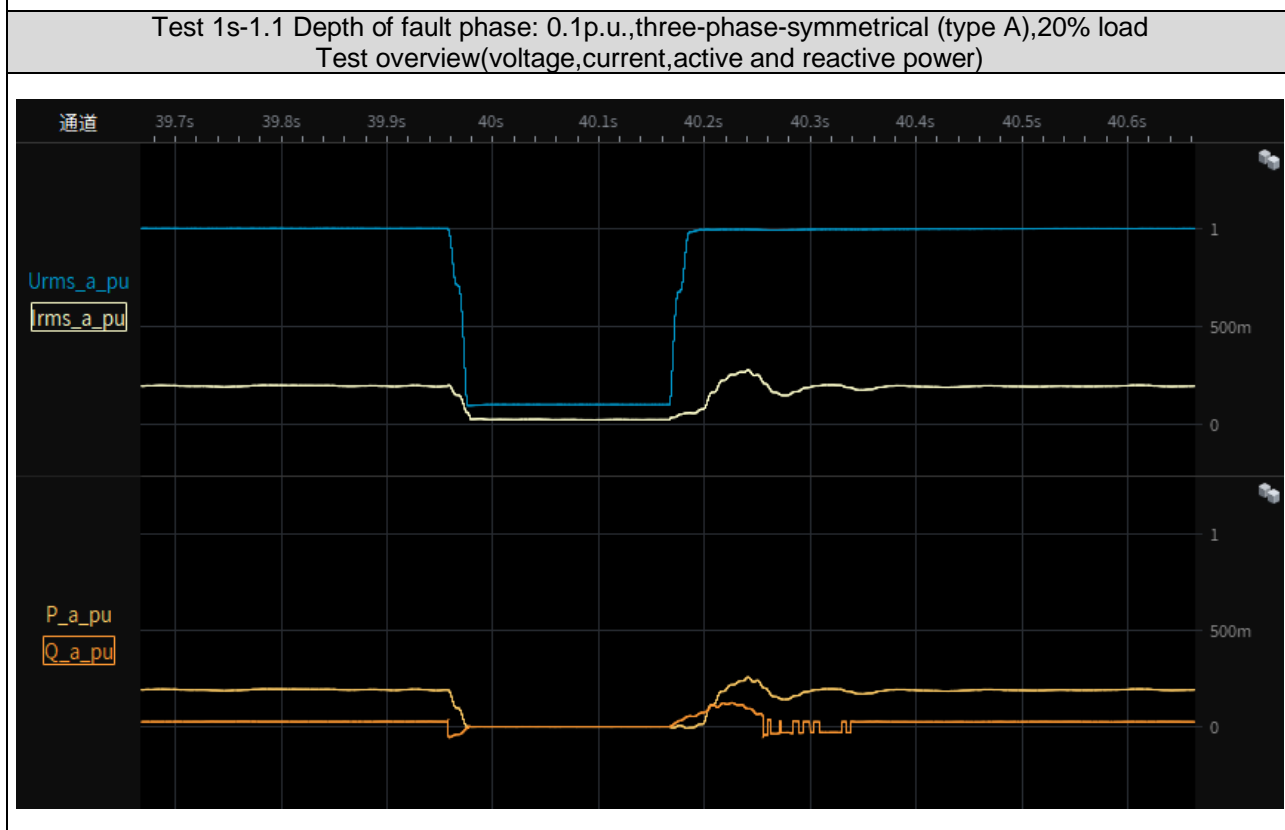
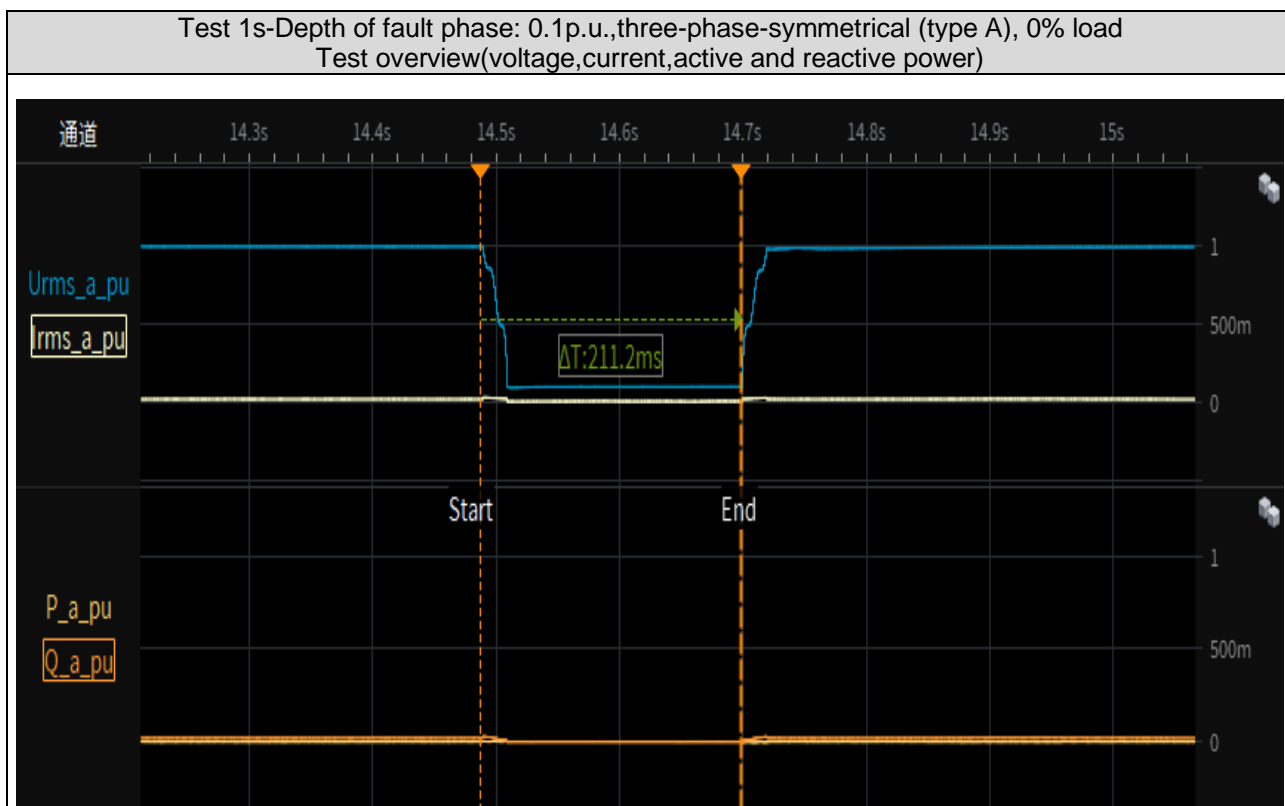

CEI 0-21			
Clause	Requirement - Test	Result - Remark	Verdict

Test 1s-1.2 Depth of fault phase: 0.1p.u.,three-phase-symmetrical (type A),20% load
Instantaneous curve and RMS value of phase-to-neutral voltages

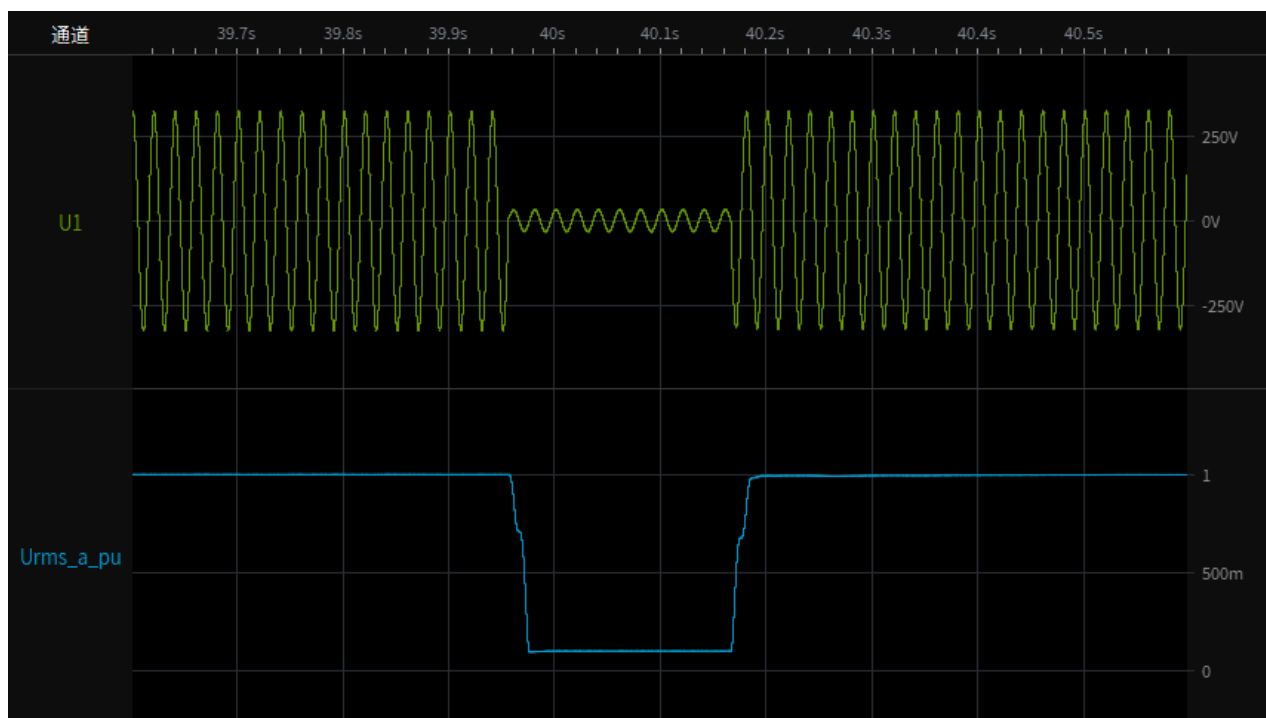

Test 1s-1.3 Depth of fault phase: 0.1p.u.,three-phase-symmetrical (type A),20% load
Instantaneous curve and RMS value of phase currents

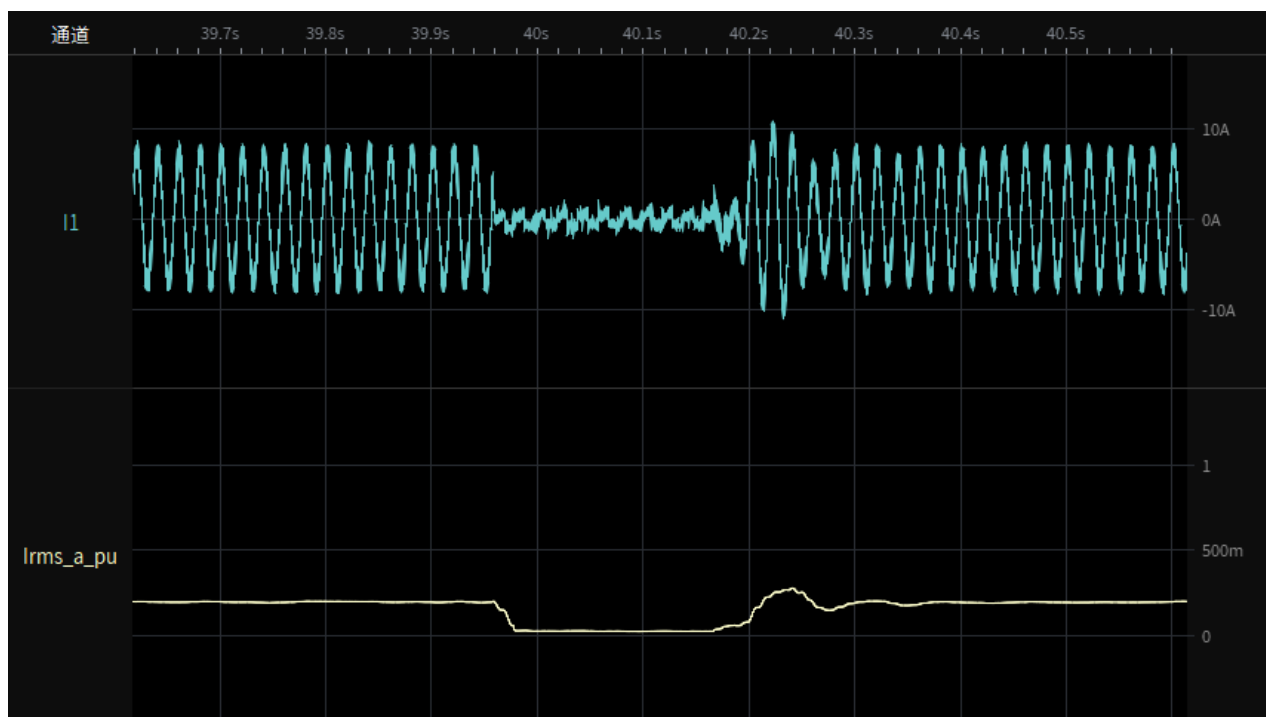

CEI 0-21			
Clause	Requirement - Test	Result - Remark	Verdict

Test 1s-1.4 Depth of fault phase: 0.1p.u.,three-phase-symmetrical (type A),20% load restoring time

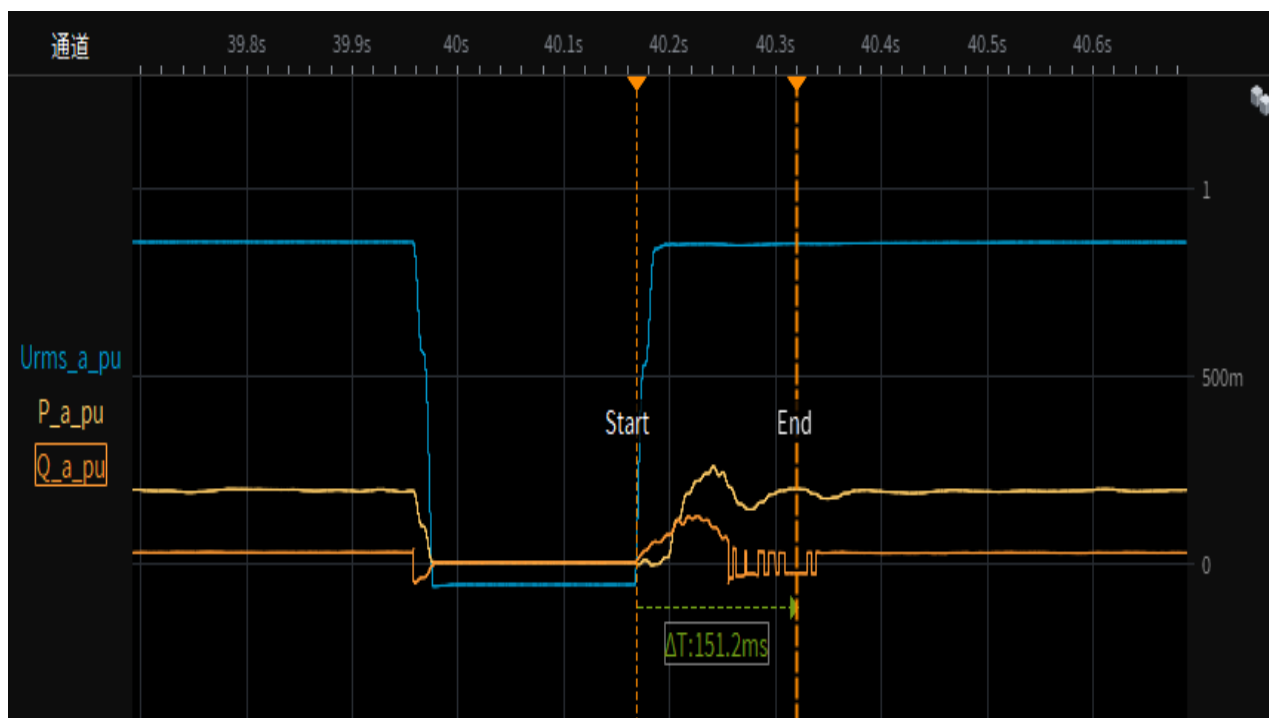

Test 1s-2.1 Depth of fault phase: 0.1p.u.,three-phase-symmetrical (type A),95% load Test overview(voltage,current,active and reactive power)

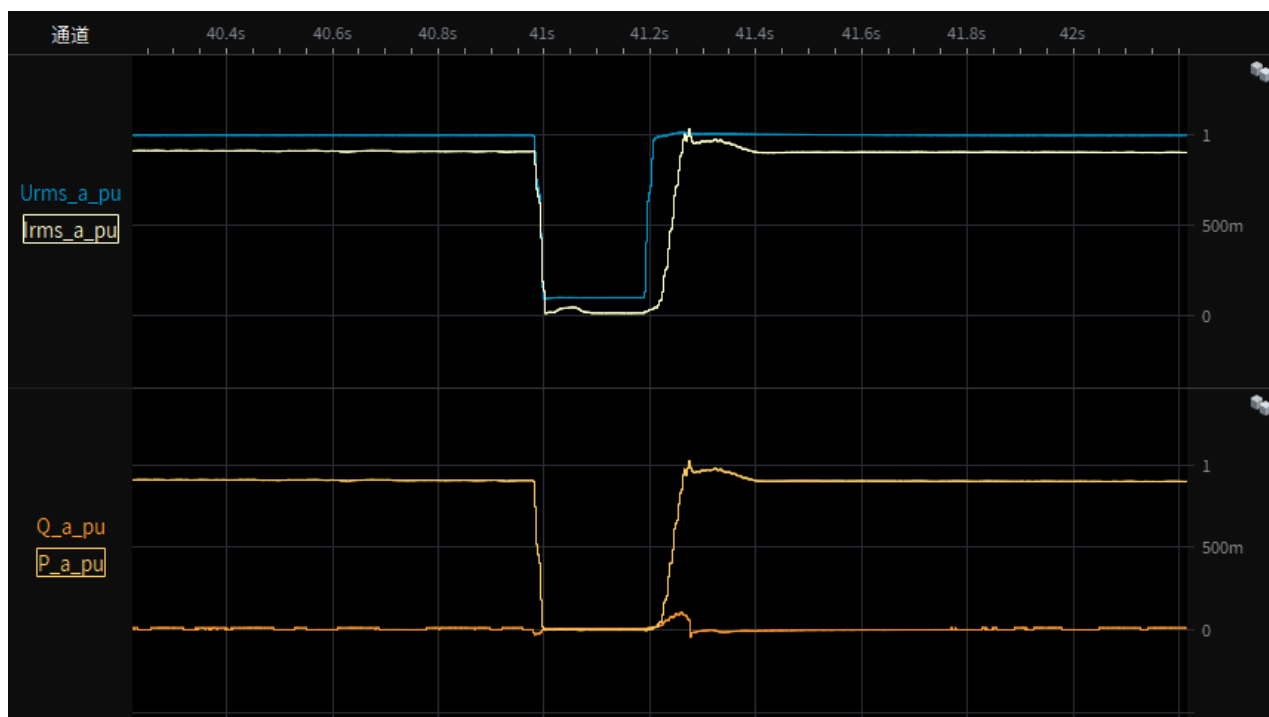

CEI 0-21			
Clause	Requirement - Test	Result - Remark	Verdict

Test 1s-2.2 Depth of fault phase: 0.1p.u.,three-phase-symmetrical (type A),95% load
Instantaneous curve and RMS value of phase-to-neutral voltages

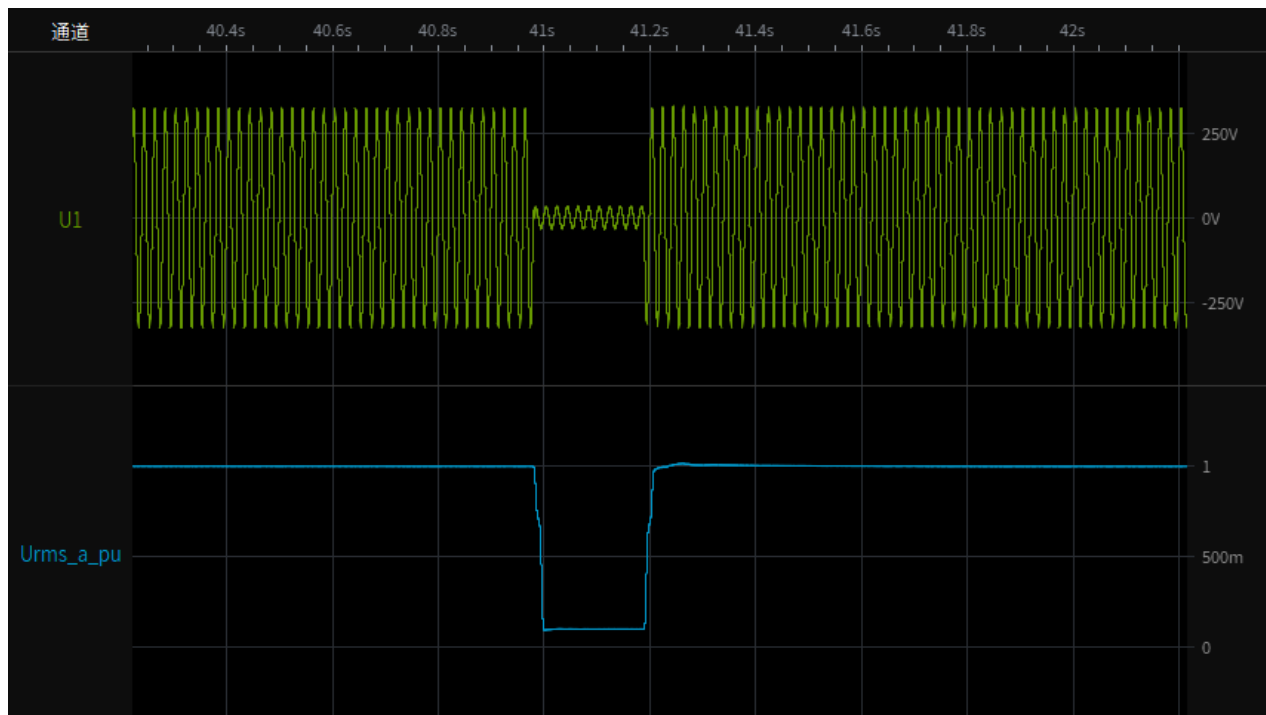

Test 1s-2.3 Depth of fault phase: 0.1p.u.,three-phase-symmetrical (type A),95% load
Instantaneous curve and RMS value of phase currents

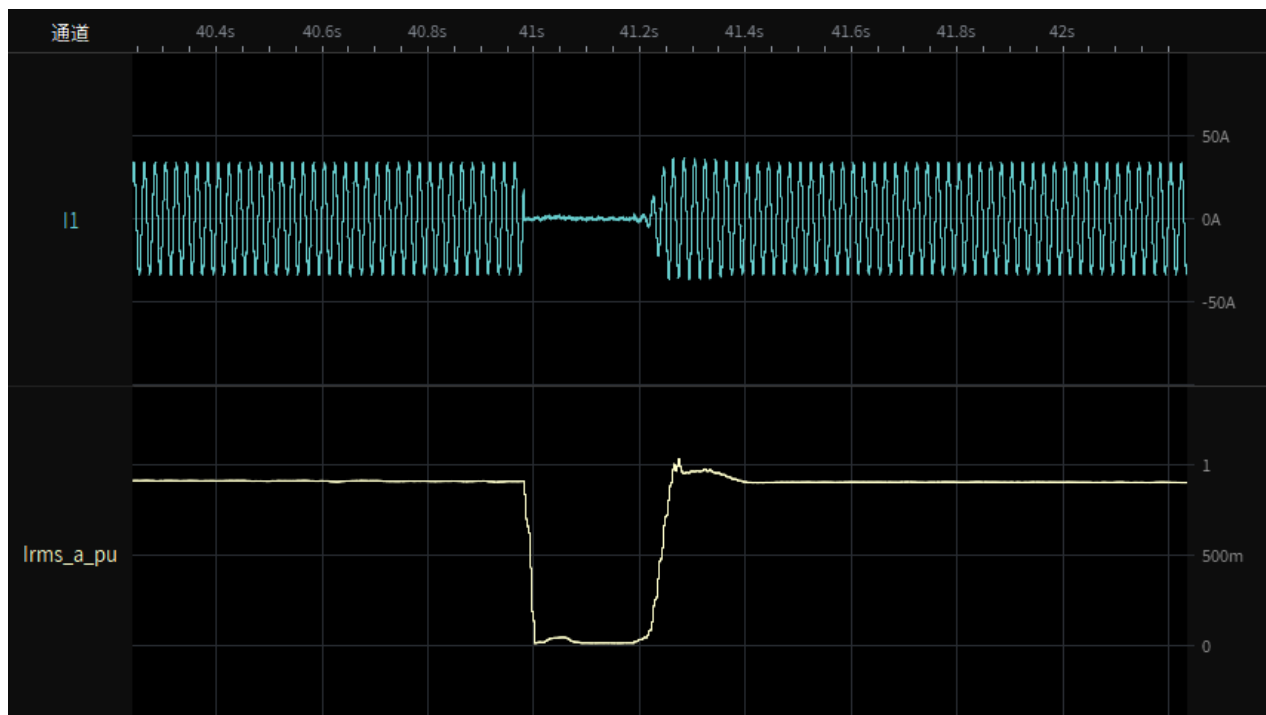

CEI 0-21			
Clause	Requirement - Test	Result - Remark	Verdict

Test 1s-2.4 Depth of fault phase: 0.1p.u.,three-phase-symmetrical (type A), 95% load restoring time

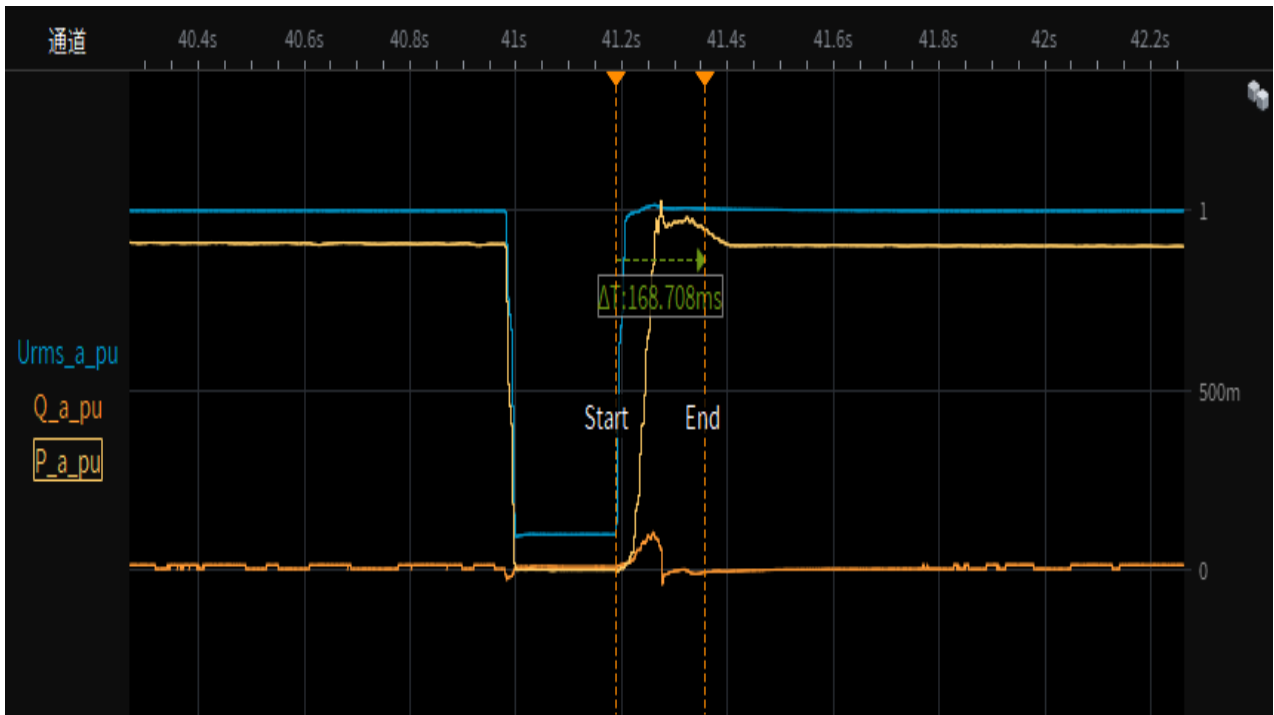

Test 1a-Depth of fault phase: 0.1p.u.,two-phase-asymmetrical (type D), 0% load Test overview(voltage,current,active and reactive power)

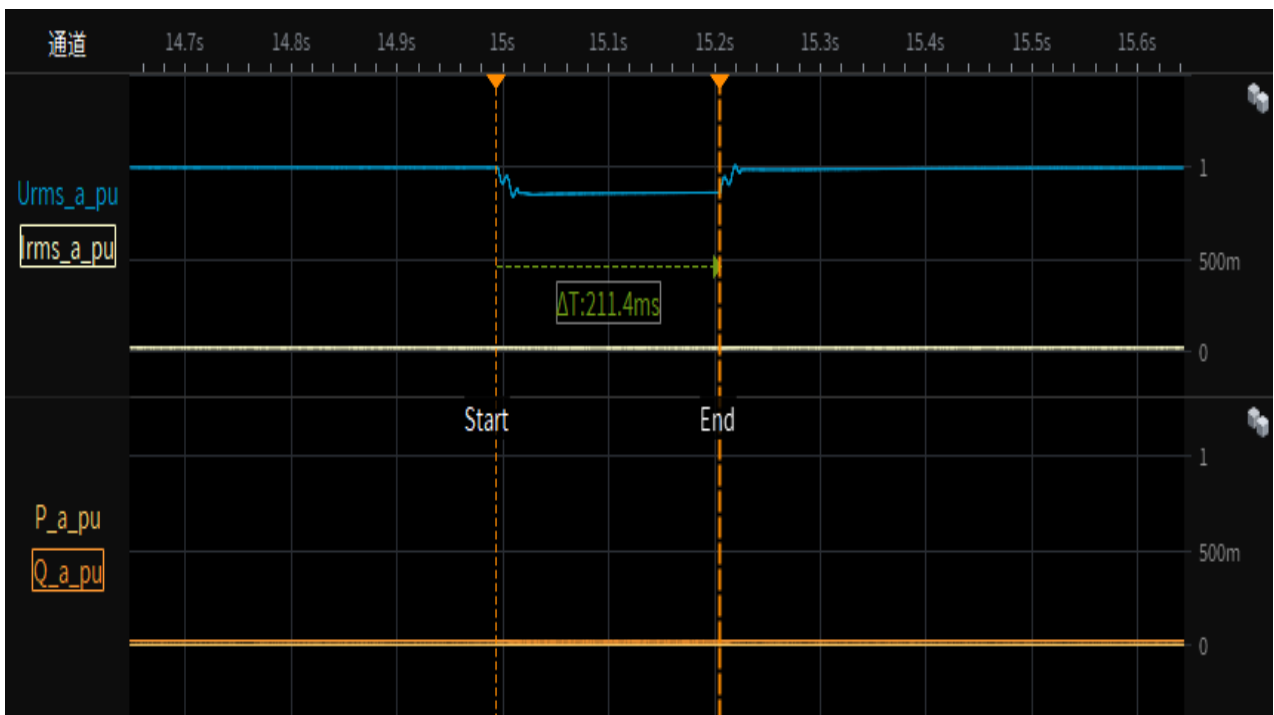

CEI 0-21			
Clause	Requirement - Test	Result - Remark	Verdict

Test 1a-1.1 Depth of fault phase: 0.1p.u., two-phase-asymmetrical (type D),20% load
 Test overview(voltage,current,active and reactive power)

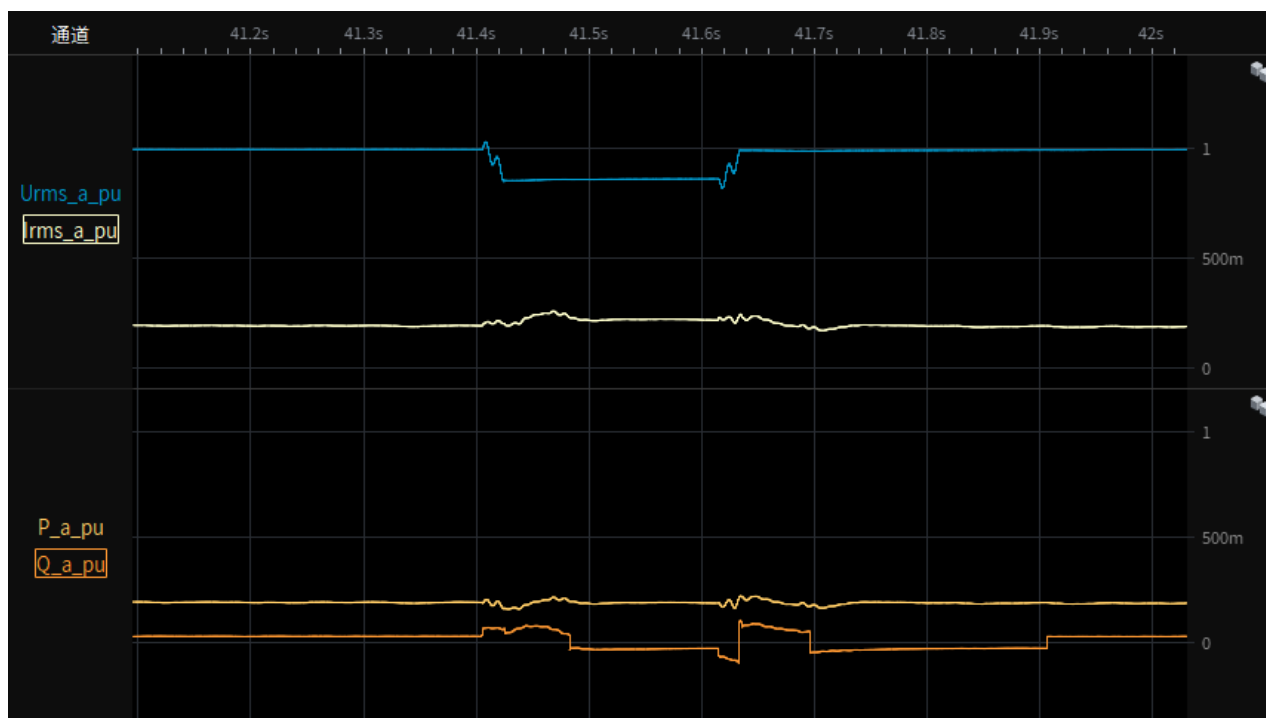

Test 1a-1.2 Depth of fault phase: 0.1p.u., two-phase-asymmetrical (type D),20% load
 Instantaneous curve and RMS value of phase-to-neutral voltages

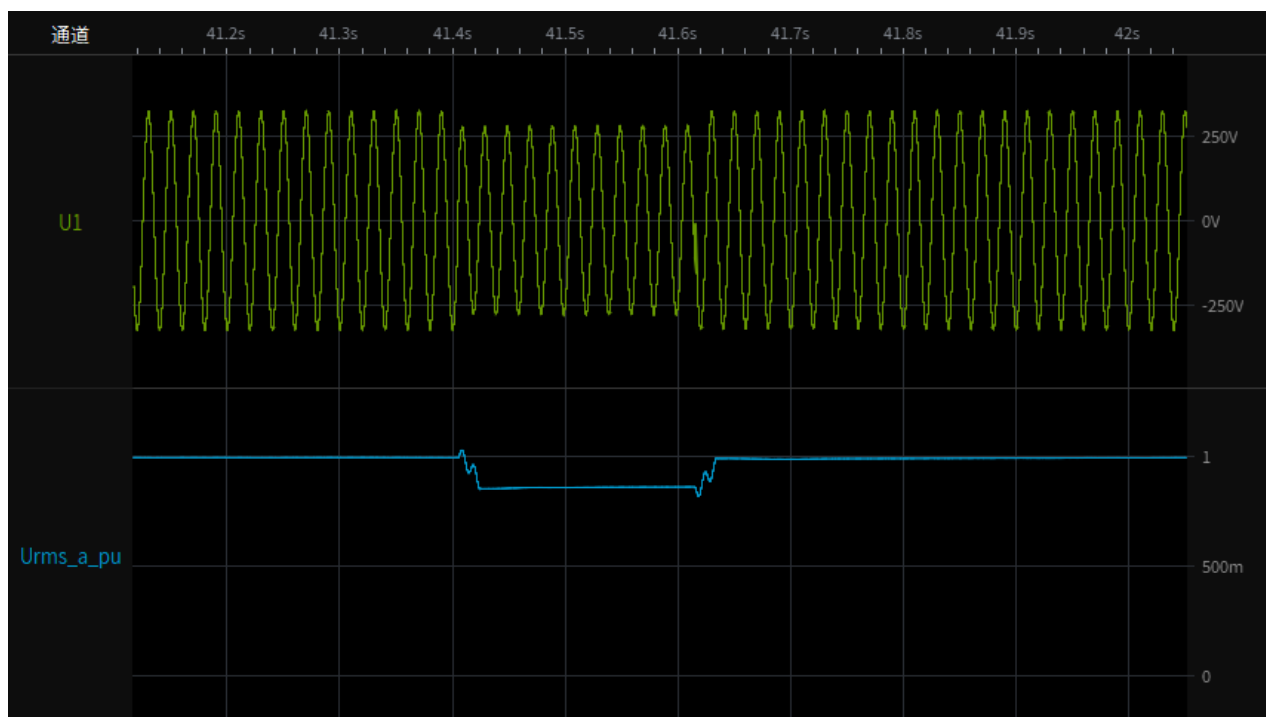

CEI 0-21			
Clause	Requirement - Test	Result - Remark	Verdict

Test 1a-1.3 Depth of fault phase: 0.1p.u., two-phase-asymmetrical (type D),20% load
Instantaneous curve and RMS value of phase currents

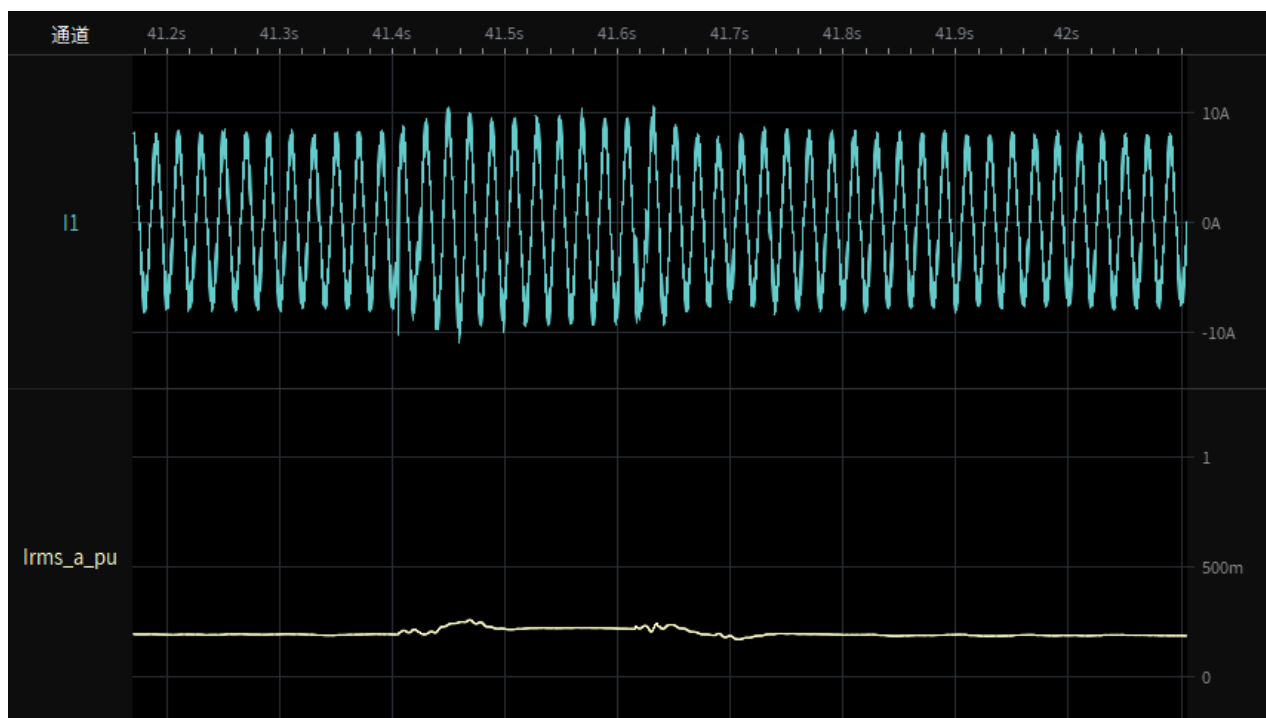

Test 1a-1.4 Depth of fault phase: 0.1p.u., two-phase-asymmetrical (type D),20% load
restoring time

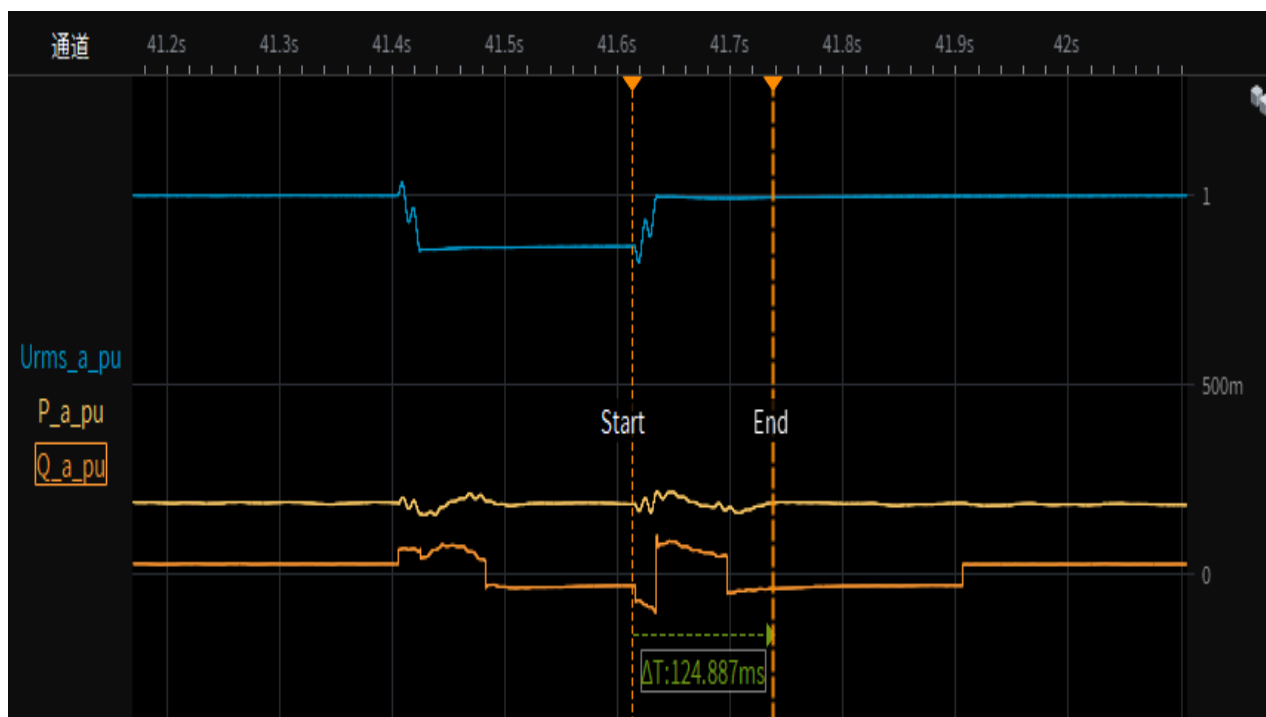

CEI 0-21			
Clause	Requirement - Test	Result - Remark	Verdict

Test 1a-2.1 Depth of fault phase: 0.1p.u., two-phase-asymmetrical (type D),95% load
Test overview(voltage,current,active and reactive power)

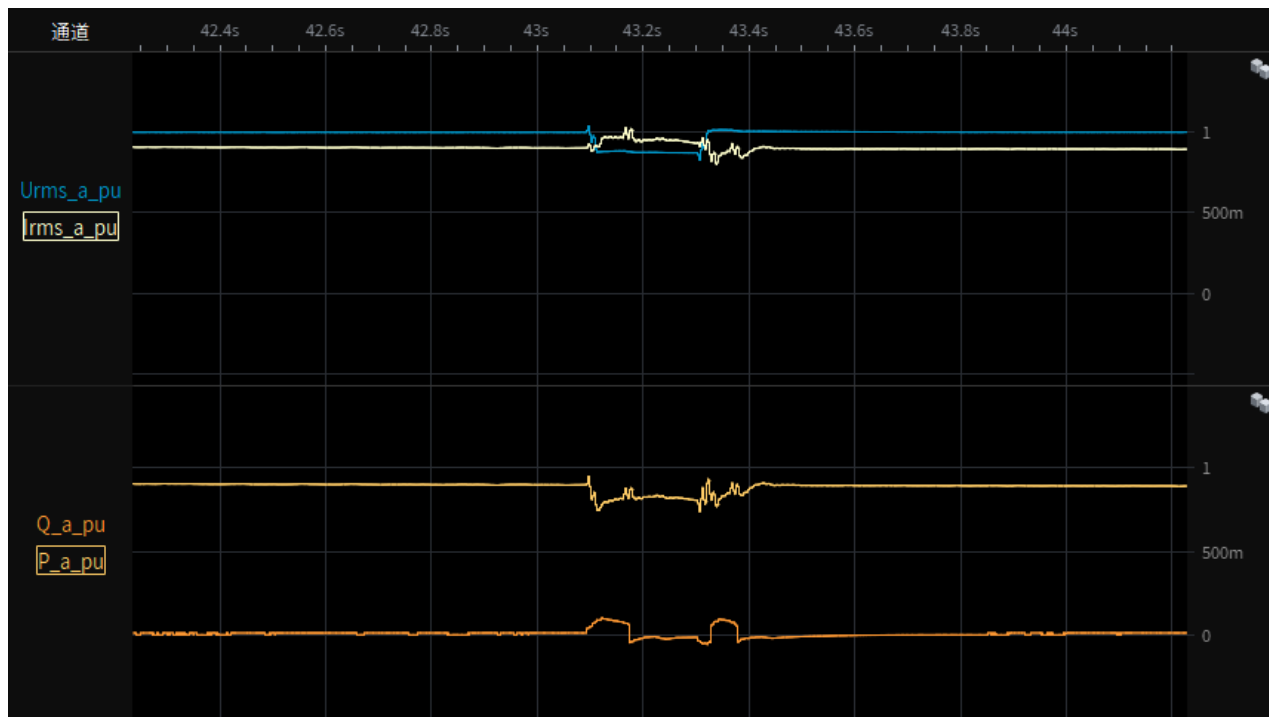

Test 1a-2.2 Depth of fault phase: 0.1p.u., two-phase-asymmetrical (type D),95% load
Instantaneous curve and RMS value of phase-to-neutral voltages

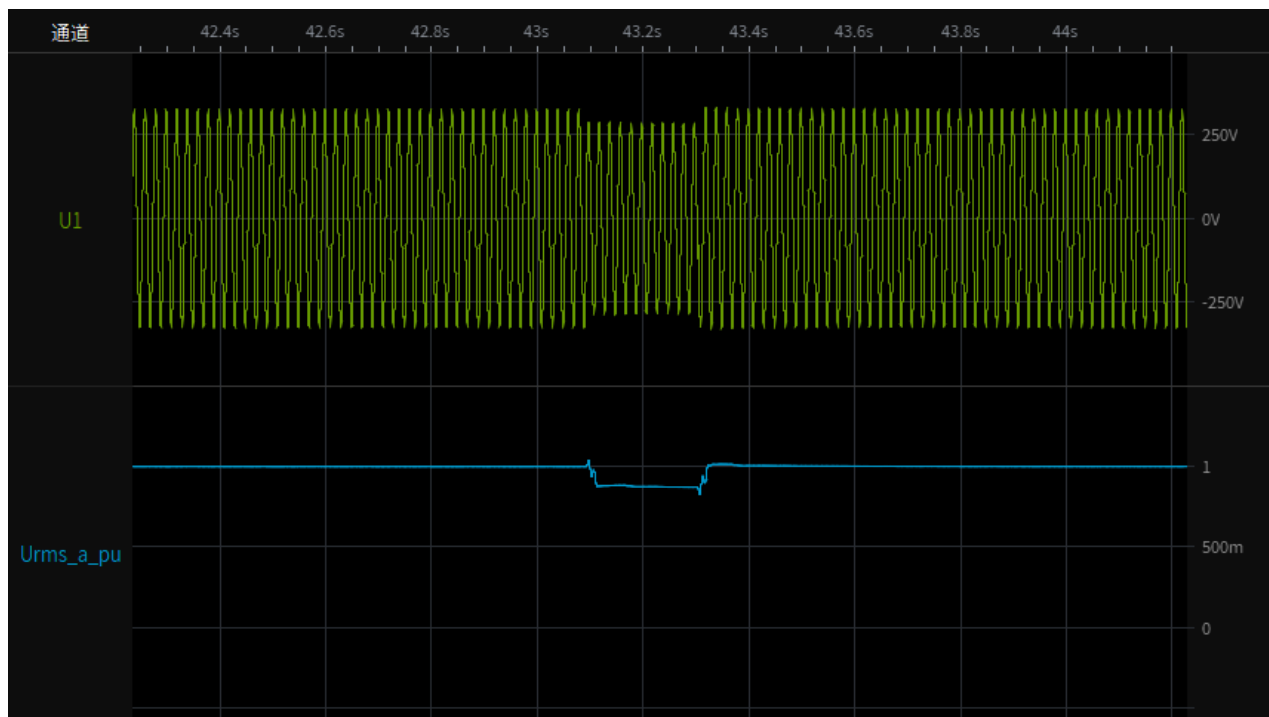

CEI 0-21			
Clause	Requirement - Test	Result - Remark	Verdict

Test 1a-2.3 Depth of fault phase: 0.1p.u., two-phase-asymmetrical (type D),95% load
Instantaneous curve and RMS value of phase currents

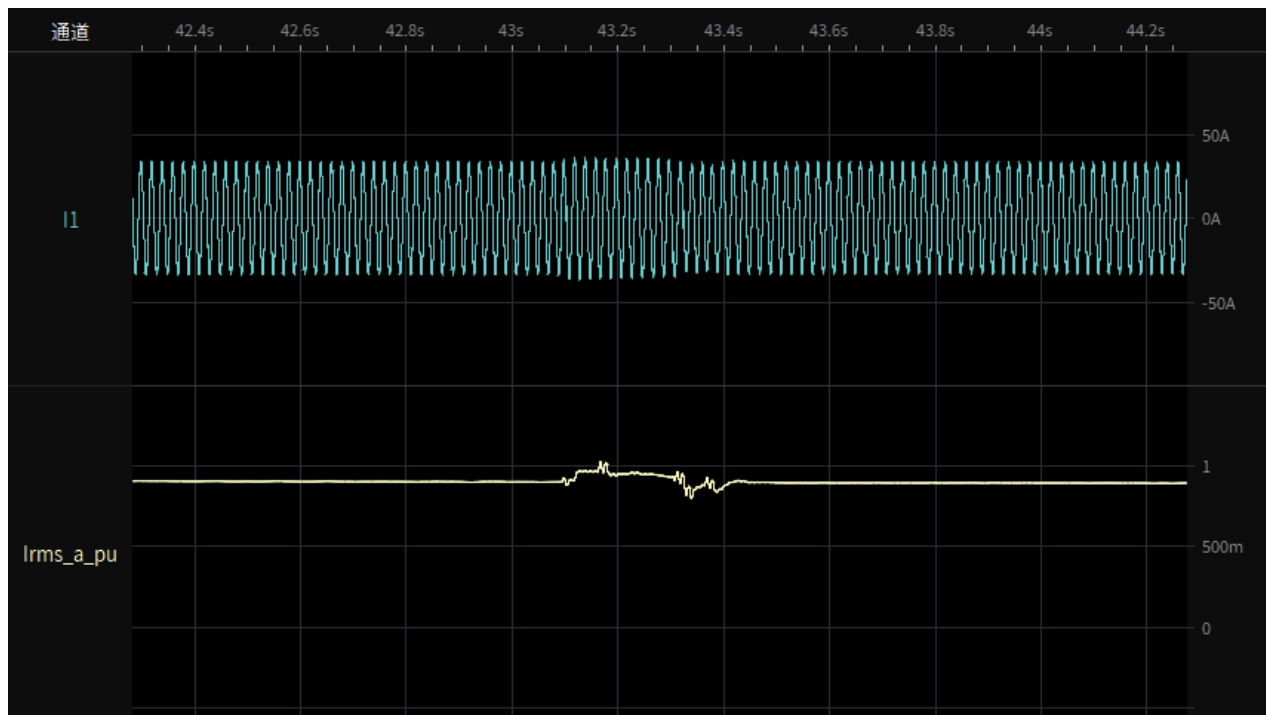

Test 1a-2.4 Depth of fault phase: 0.1p.u., two-phase-asymmetrical (type D), 95% load
restoring time

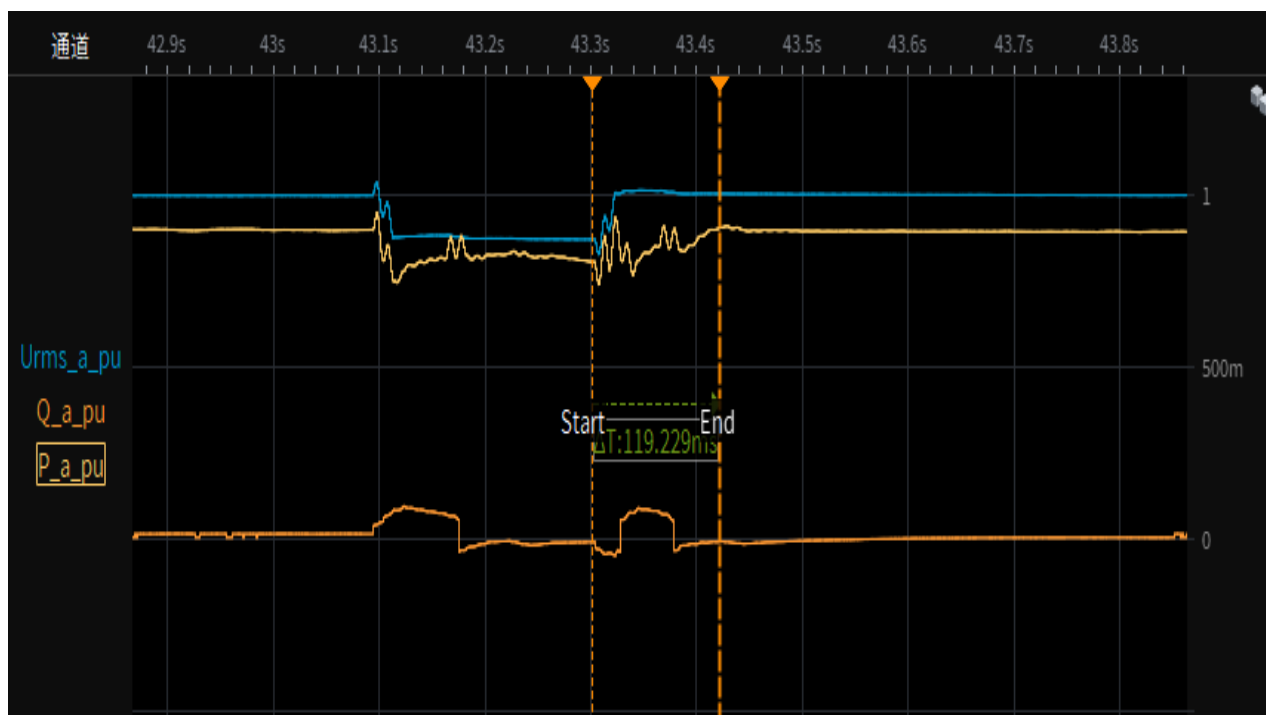

CEI 0-21			
Clause	Requirement - Test	Result - Remark	Verdict

Test 2s-Depth of fault phase: 0.25p.u.,three-phase-symmetrical (type A), 0% load
Test overview(voltage,current,active and reactive power)

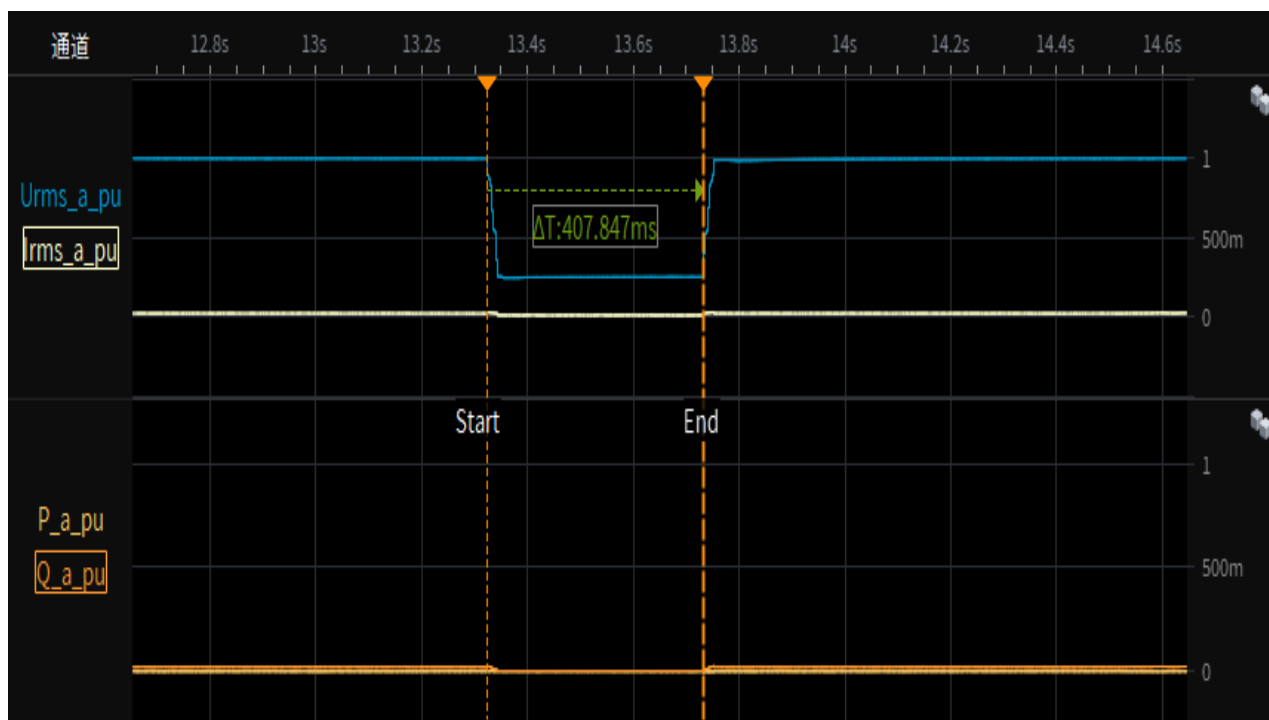

Test 2s-1.1 Depth of fault phase: 0.25p.u.,three-phase-symmetrical (type A),20% load
Test overview(voltage,current,active and reactive power)

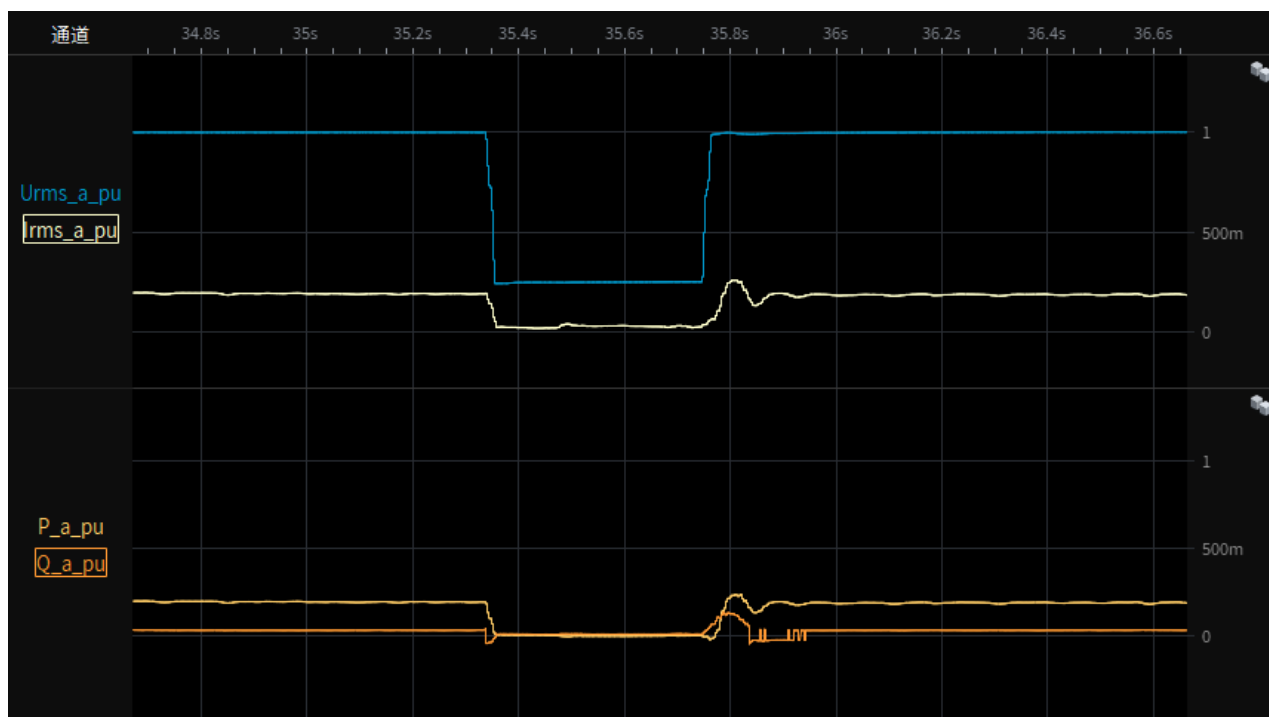

CEI 0-21			
Clause	Requirement - Test	Result - Remark	Verdict

Test 2s-1.2 Depth of fault phase: 0.25p.u.,three-phase-symmetrical (type A),20% load
Instantaneous curve and RMS value of phase-to-neutral voltages

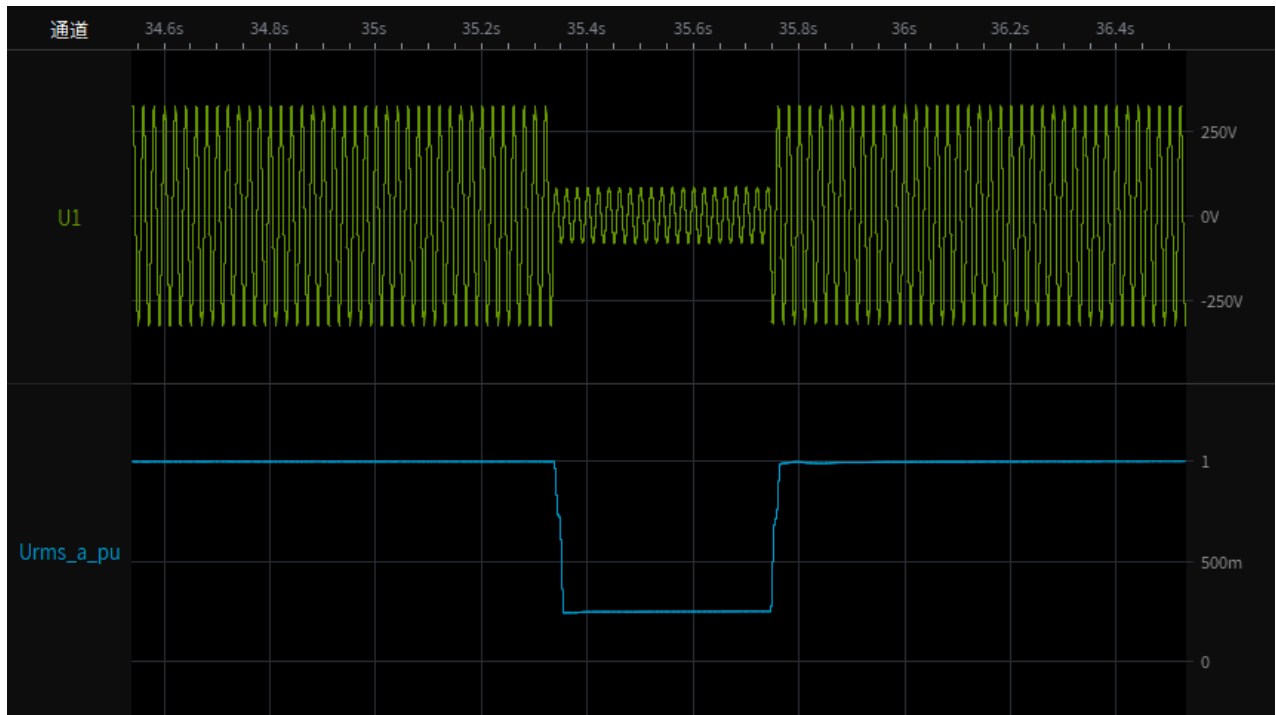

Test 2s-1.3 Depth of fault phase: 0.25p.u.,three-phase-symmetrical (type A),20% load
Instantaneous curve and RMS value of phase currents

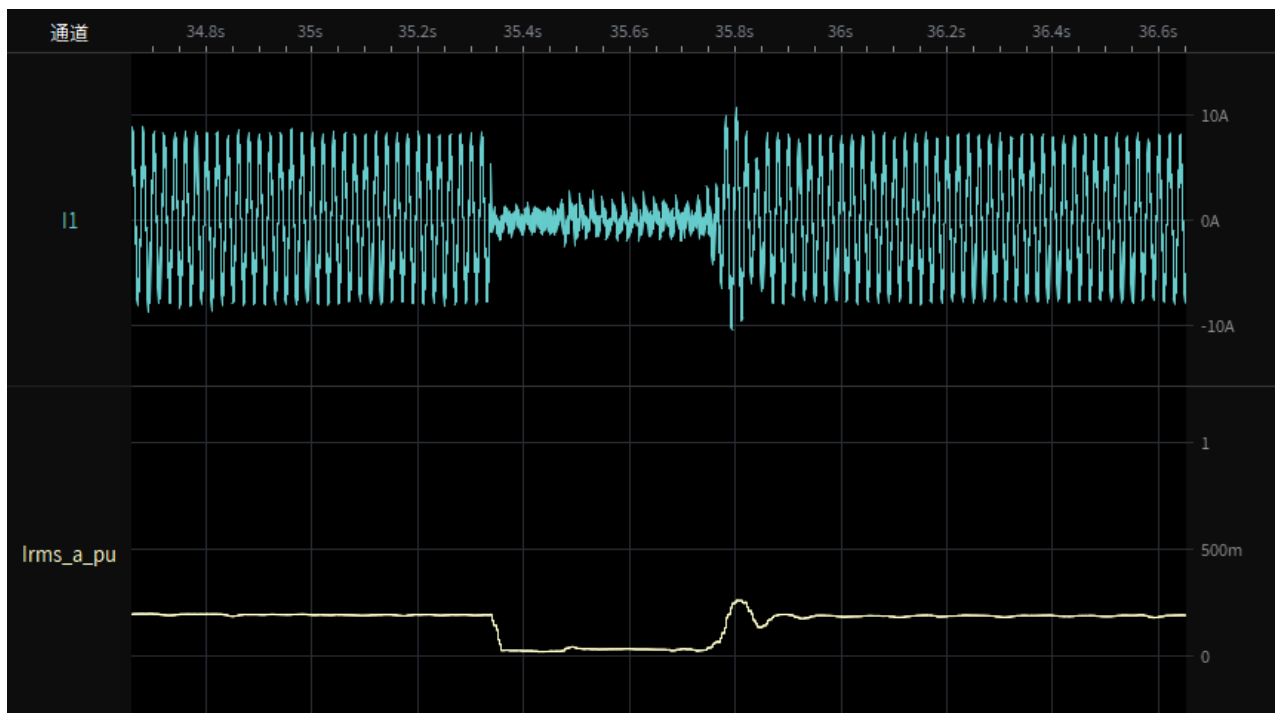

CEI 0-21			
Clause	Requirement - Test	Result - Remark	Verdict

Test 2s-1.4 Depth of fault phase: 0.25p.u.,three-phase-symmetrical (type A),20% load restoring time

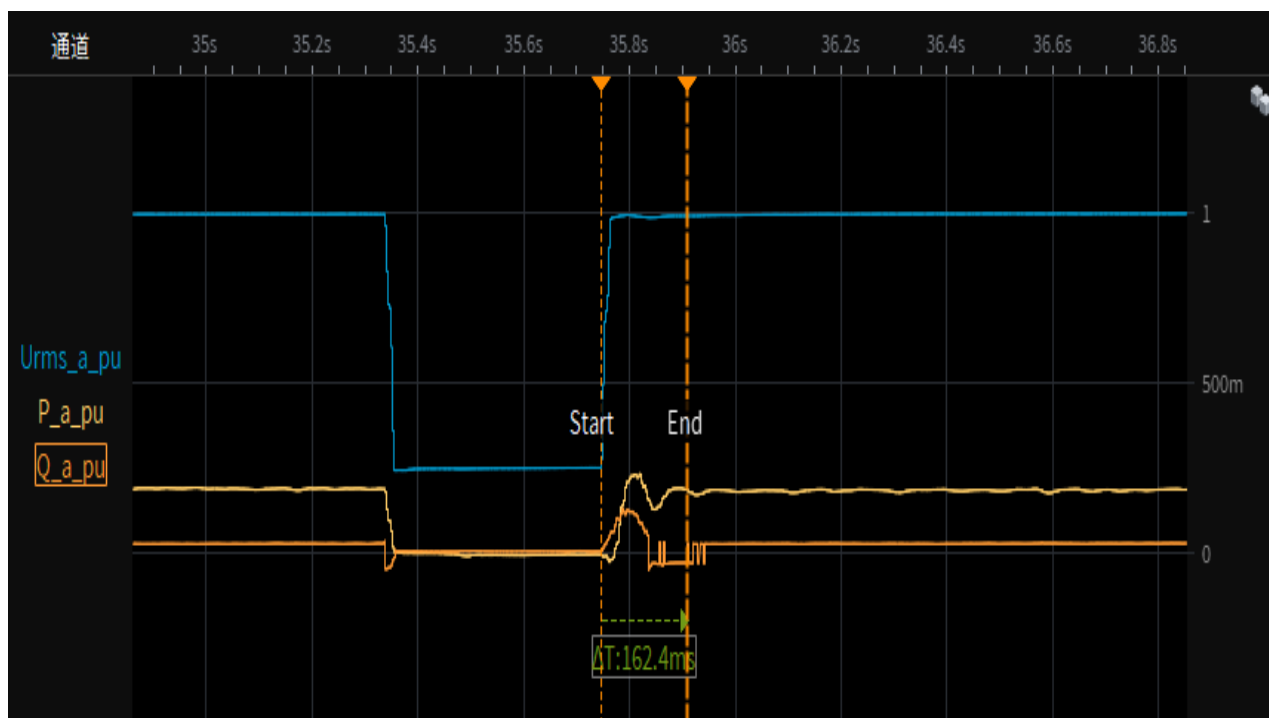

Test 2s-2.1 Depth of fault phase: 0.25p.u.,three-phase-symmetrical (type A),95% load Test overview(voltage,current,active and reactive power)

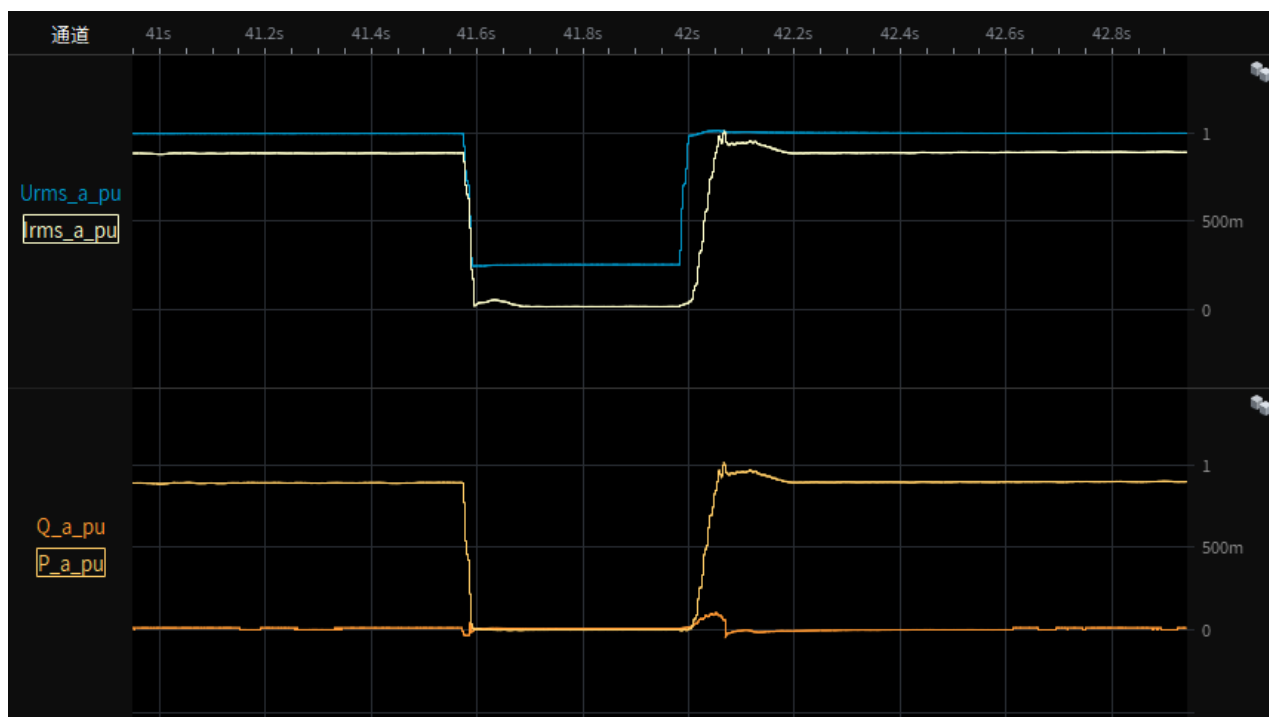

CEI 0-21			
Clause	Requirement - Test	Result - Remark	Verdict

Test 2s-2.2 Depth of fault phase: 0.25p.u.,three-phase-symmetrical (type A),95% load
Instantaneous curve and RMS value of phase-to-neutral voltages

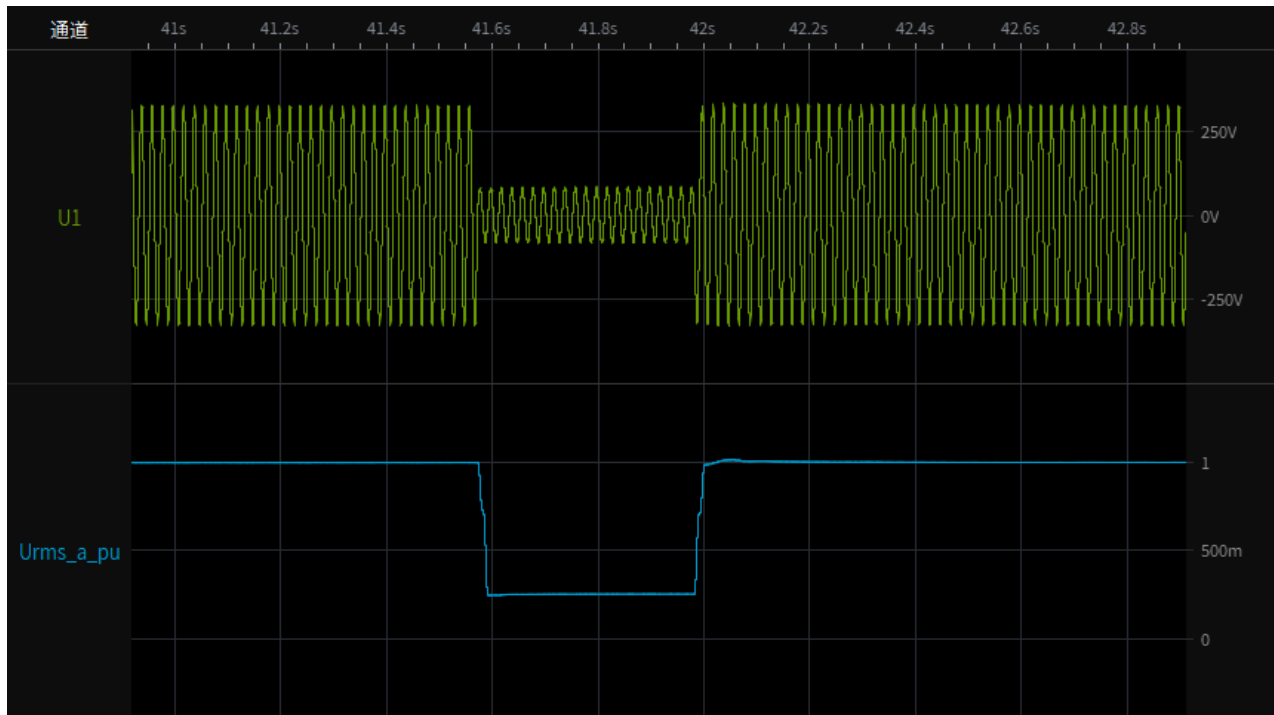

Test 2s-2.3 Depth of fault phase: 0.25p.u.,three-phase-symmetrical (type A),95% load
Instantaneous curve and RMS value of phase currents

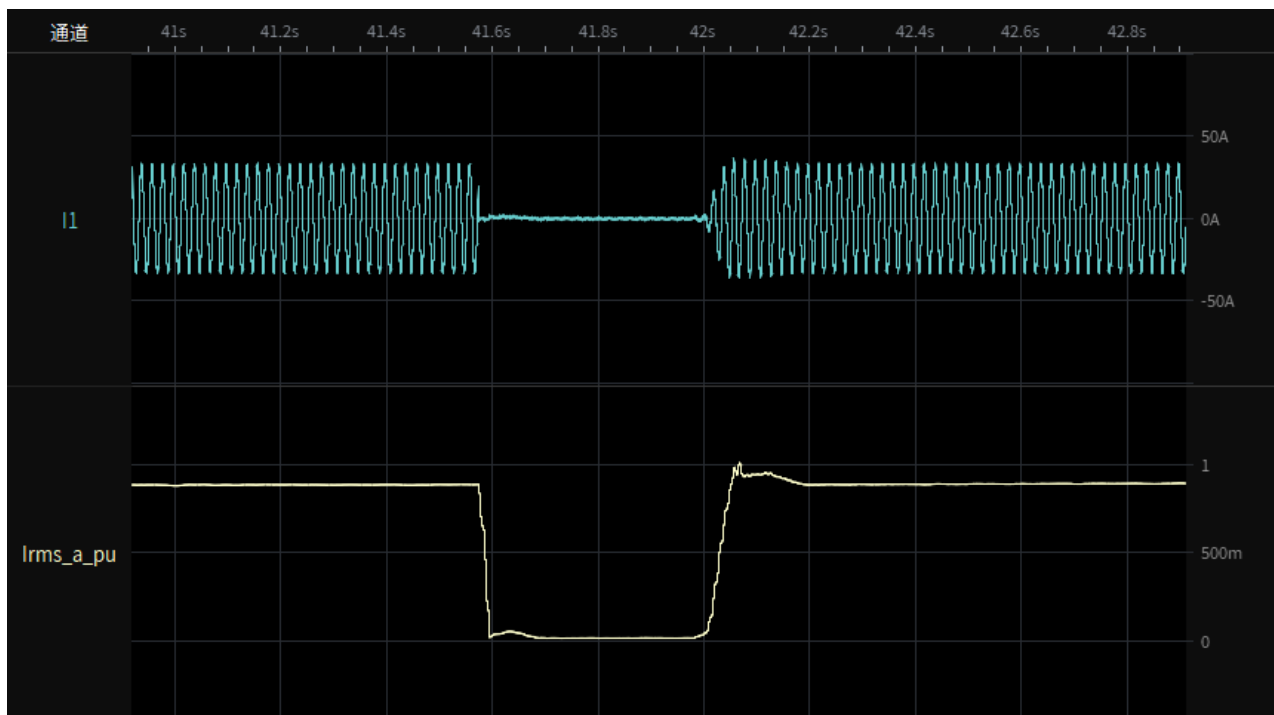

CEI 0-21			
Clause	Requirement - Test	Result - Remark	Verdict

Test 2s-2.4 Depth of fault phase: 0.25p.u.,three-phase-symmetrical (type A), 95% load restoring time

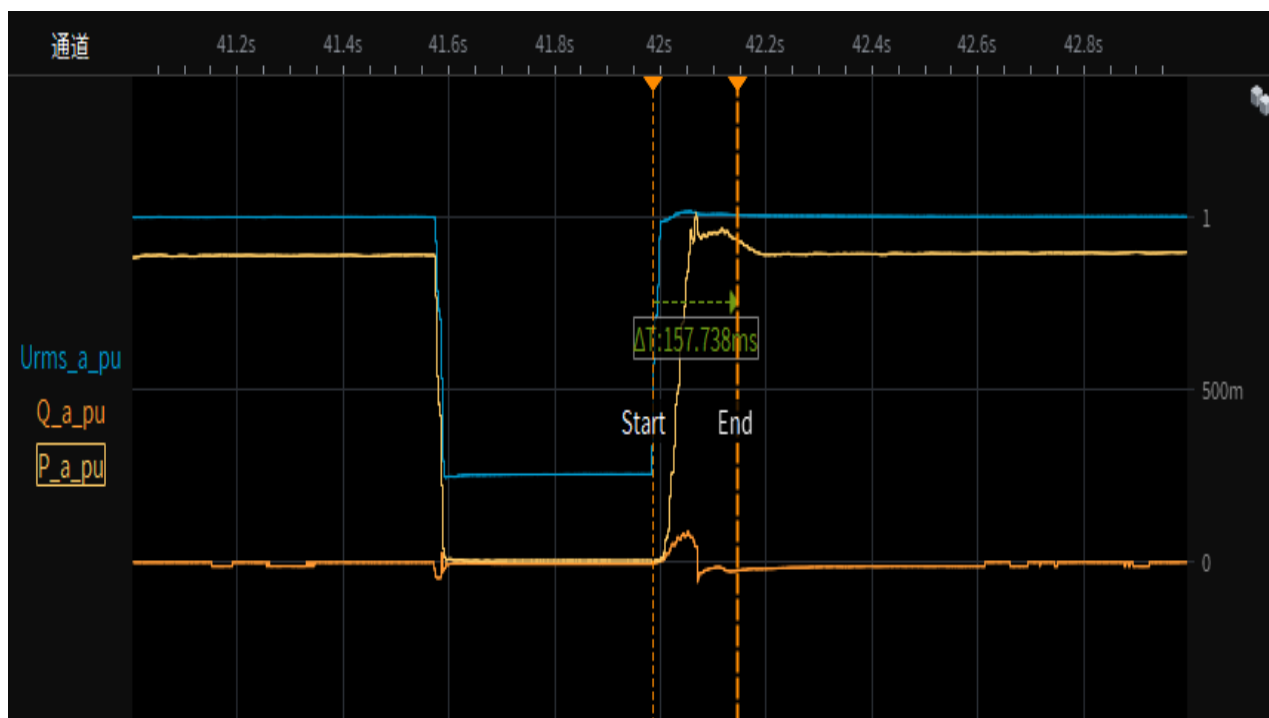

Test 2a-Depth of fault phase: 0.25p.u.,two-phase-asymmetrical (type D), 0% load Test overview(voltage,current,active and reactive power)

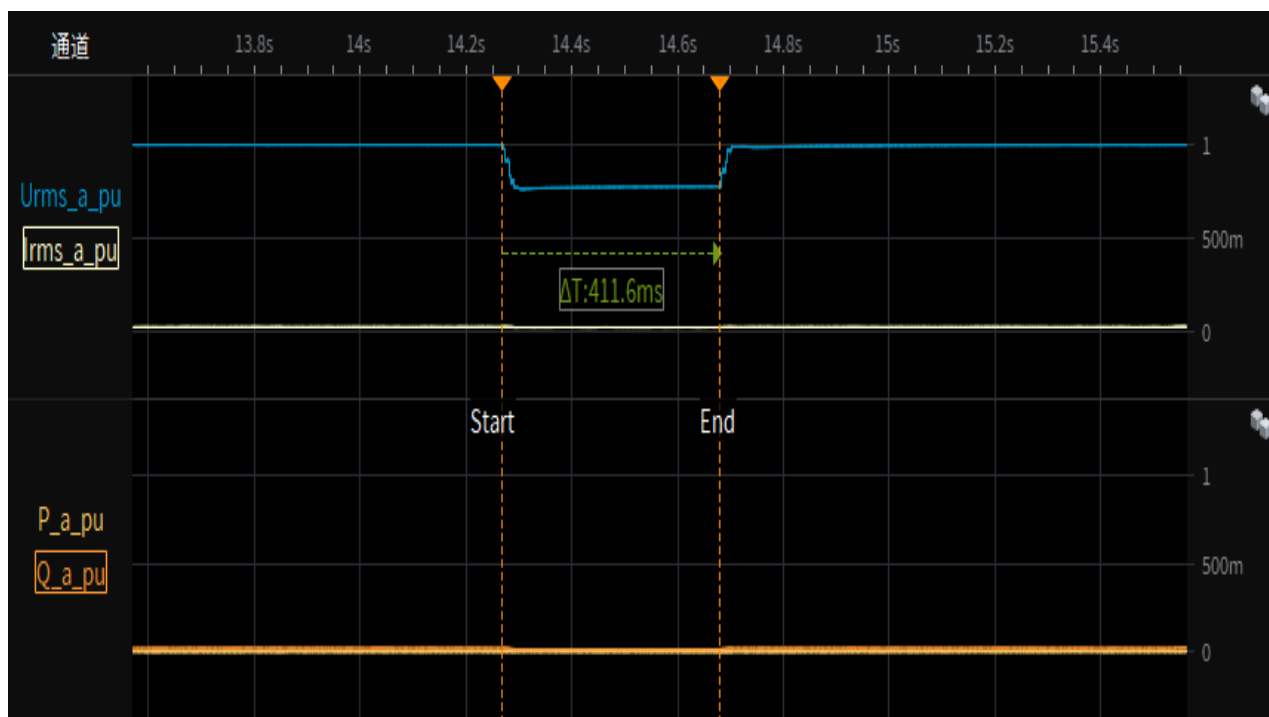

CEI 0-21			
Clause	Requirement - Test	Result - Remark	Verdict

Test 2a-1.1 Depth of fault phase: 0.25p.u.,two-phase-asymmetrical (type D),20% load
Test overview(voltage,current,active and reactive power)

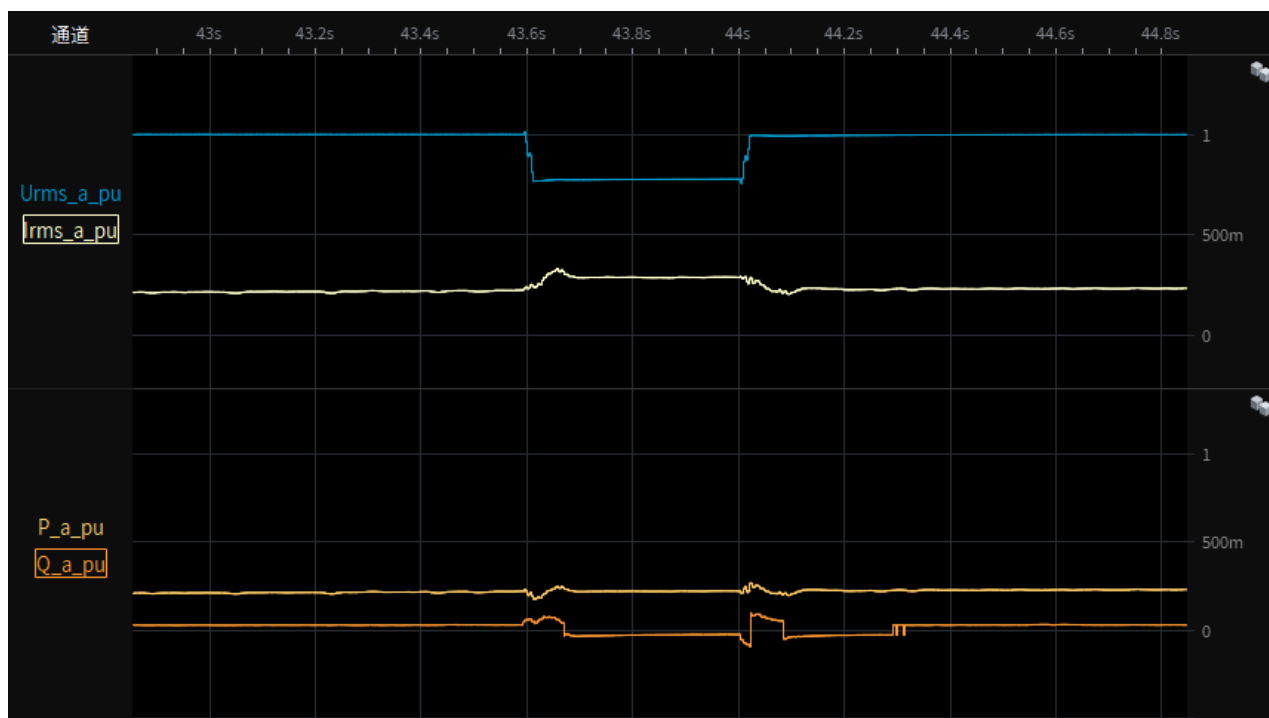

Test 2a-1.2 Depth of fault phase: 0.25p.u.,two-phase-asymmetrical (type D),20% load
Instantaneous curve and RMS value of phase-to-neutral voltages

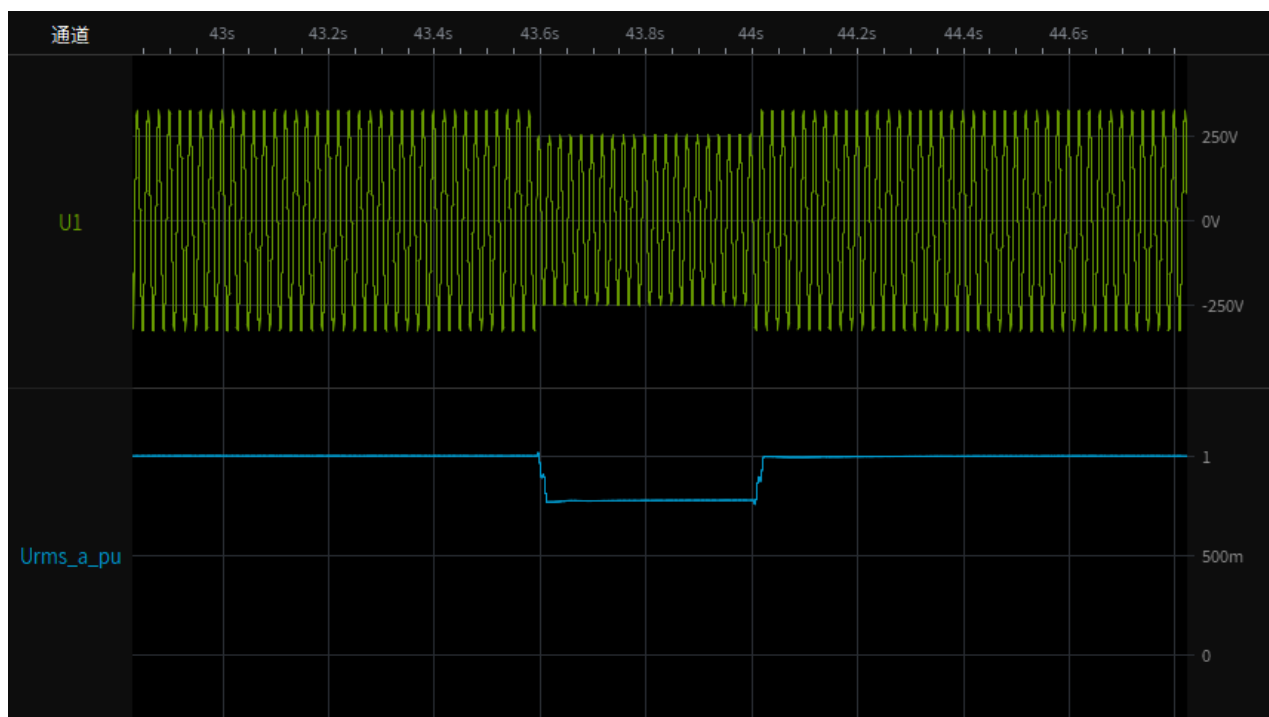

CEI 0-21			
Clause	Requirement - Test	Result - Remark	Verdict

Test 2a-1.3 Depth of fault phase: 0.25p.u.,two-phase-asymmetrical (type D),20% load
Instantaneous curve and RMS value of phase currents

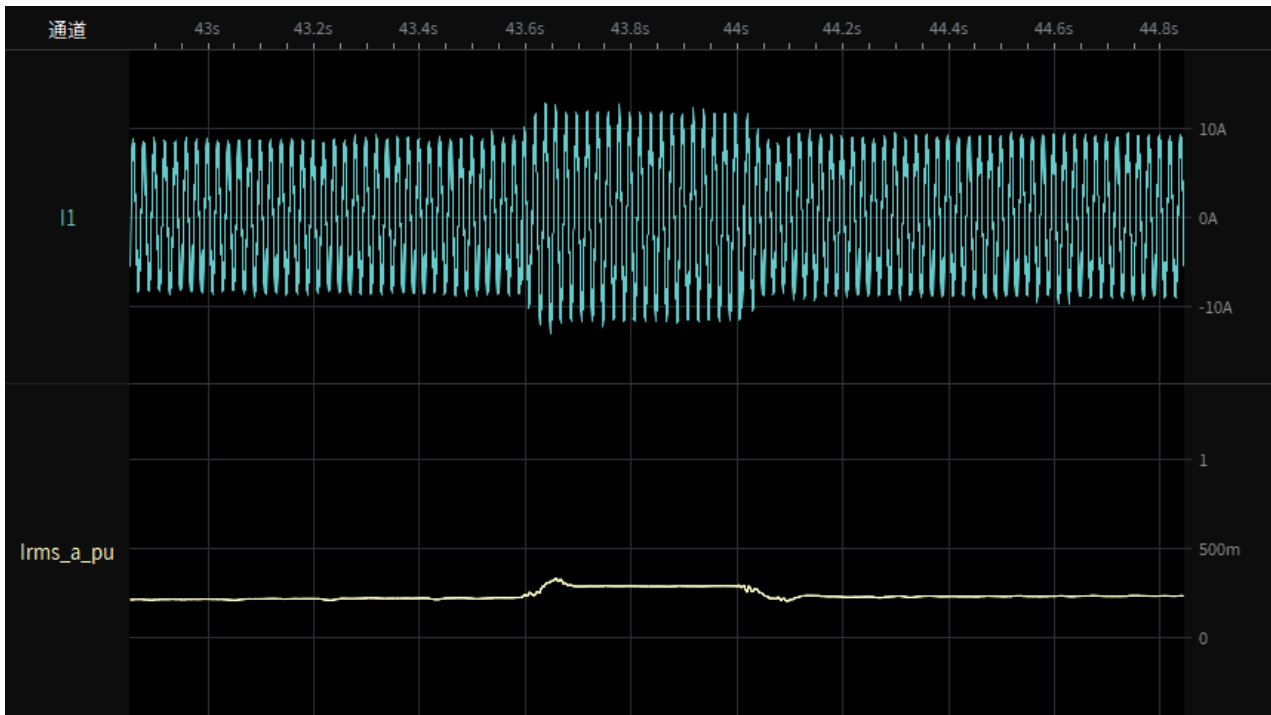

Test 2a-1.4 Depth of fault phase: 0.25p.u.,two-phase-asymmetrical (type D),20% load
restoring time

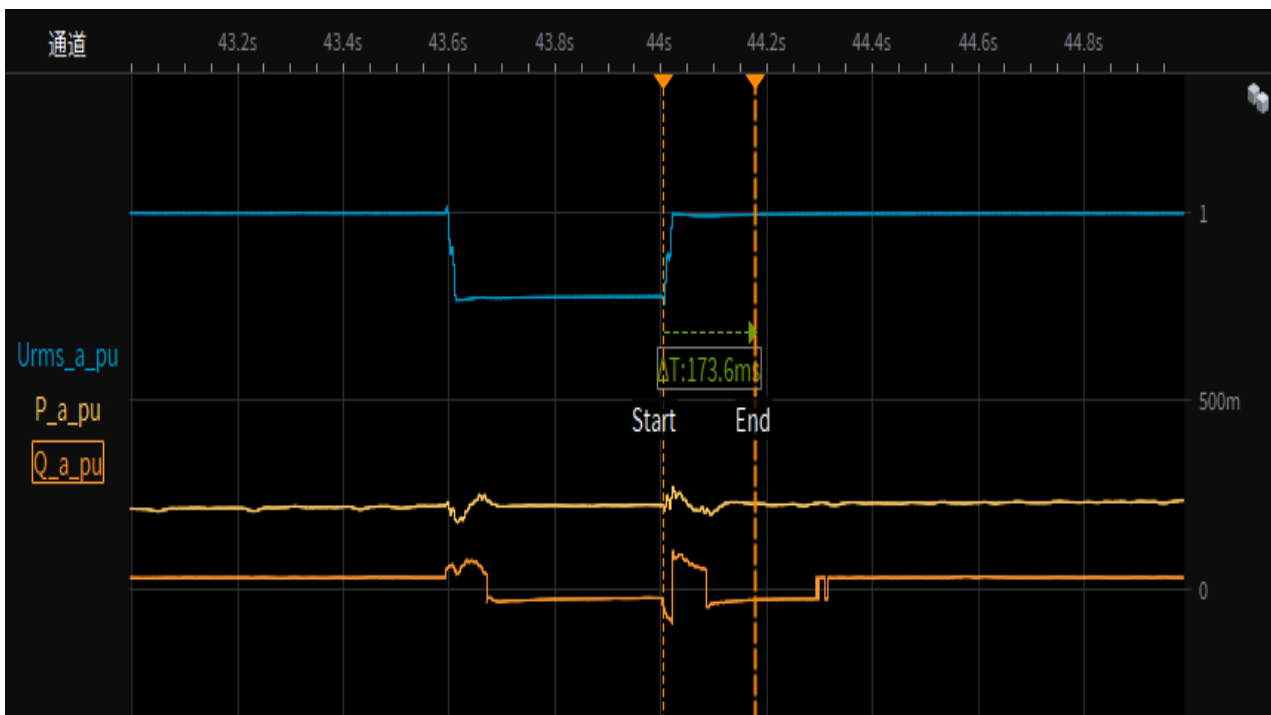

CEI 0-21			
Clause	Requirement - Test	Result - Remark	Verdict

Test 2a-2.1 Depth of fault phase: 0.25p.u.,two-phase-asymmetrical (type D),95% load
Test overview(voltage,current,active and reactive power)

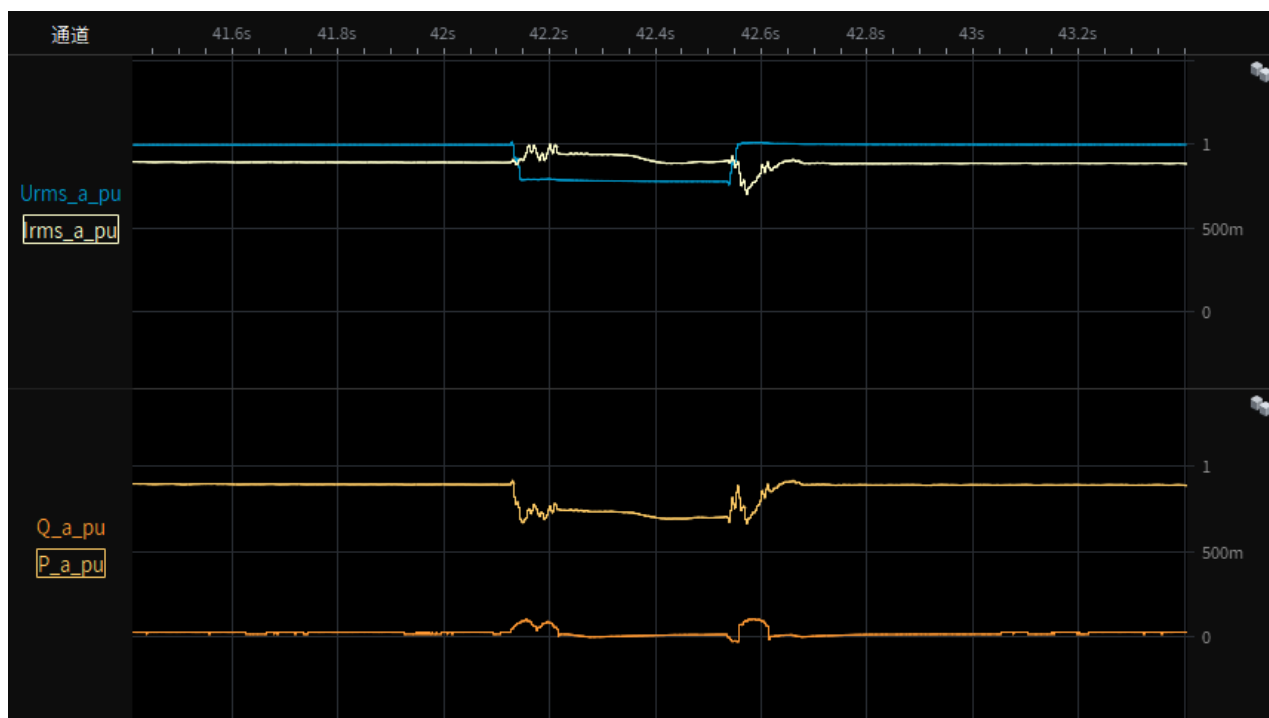

Test 2a-2.2 Depth of fault phase: 0.25p.u.,two-phase-asymmetrical (type D),95% load
Instantaneous curve and RMS value of phase-to-neutral voltages

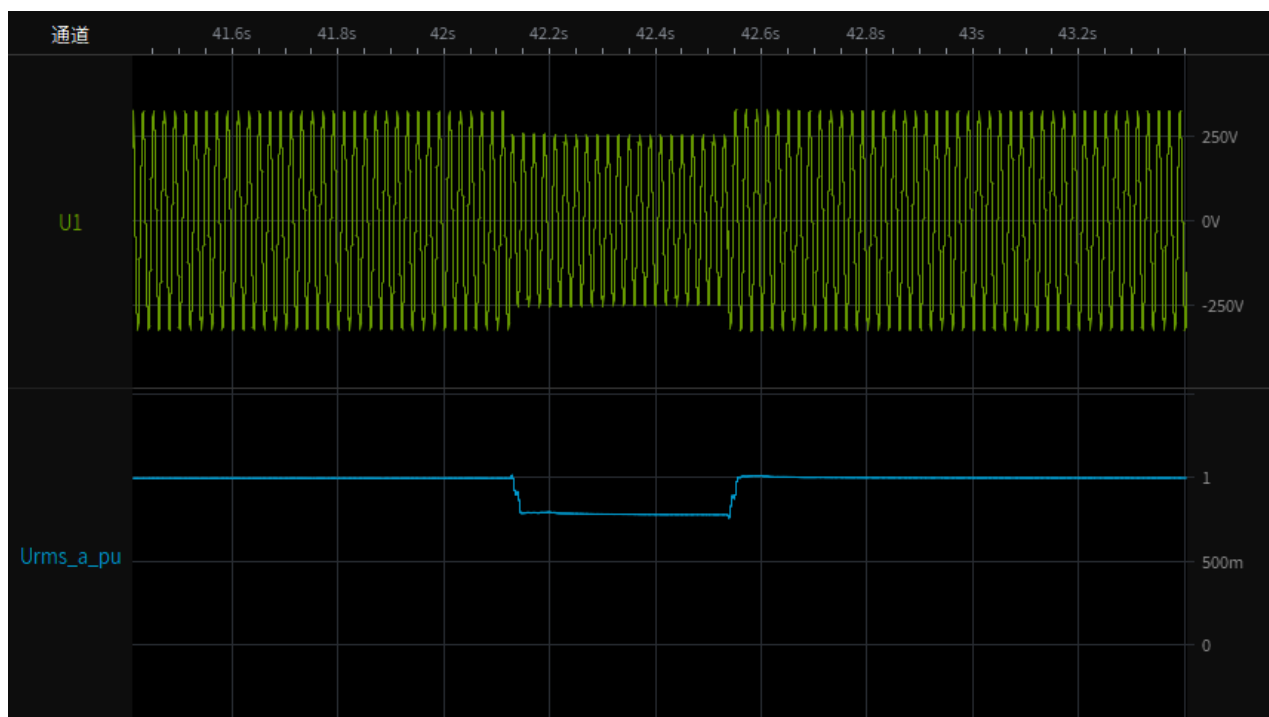

CEI 0-21			
Clause	Requirement - Test	Result - Remark	Verdict

Test 2a-2.3 Depth of fault phase: 0.25p.u., two-phase-asymmetrical (type D), 95% load
Instantaneous curve and RMS value of phase currents

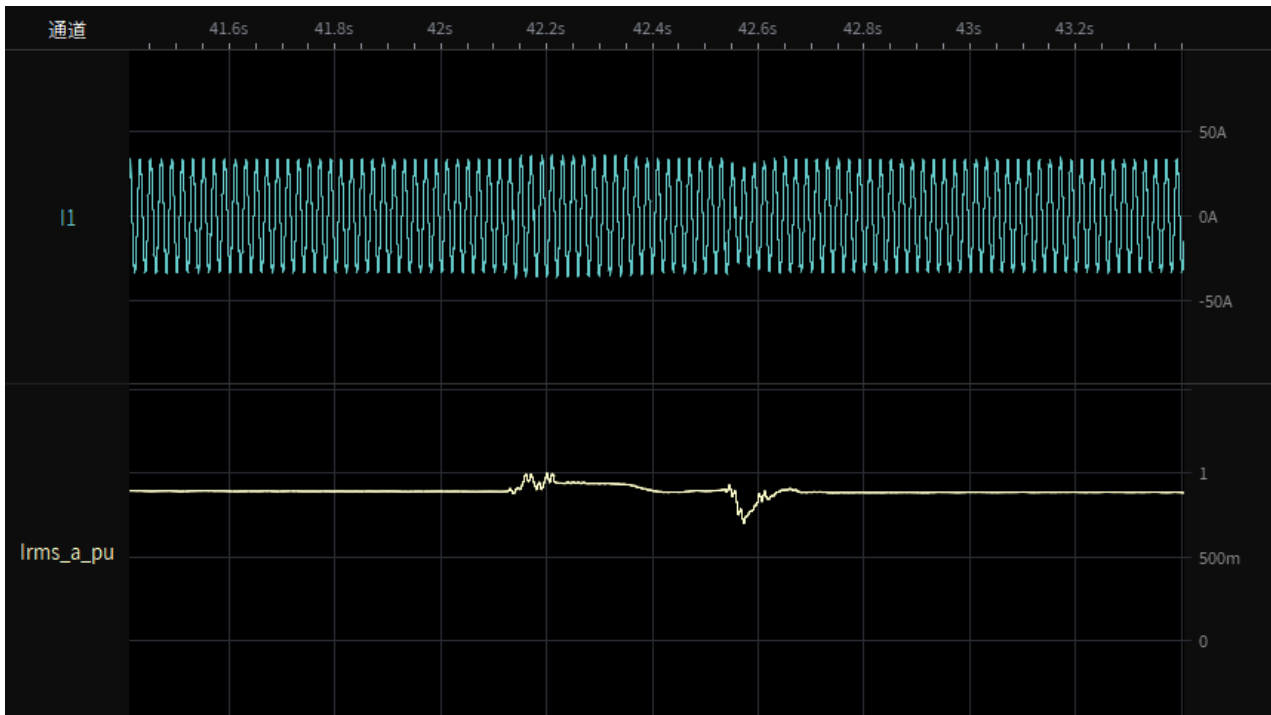

Test 2a-2.4 Depth of fault phase: 0.25p.u., two-phase-asymmetrical (type D), 95% load
restoring time



CEI 0-21			
Clause	Requirement - Test	Result - Remark	Verdict

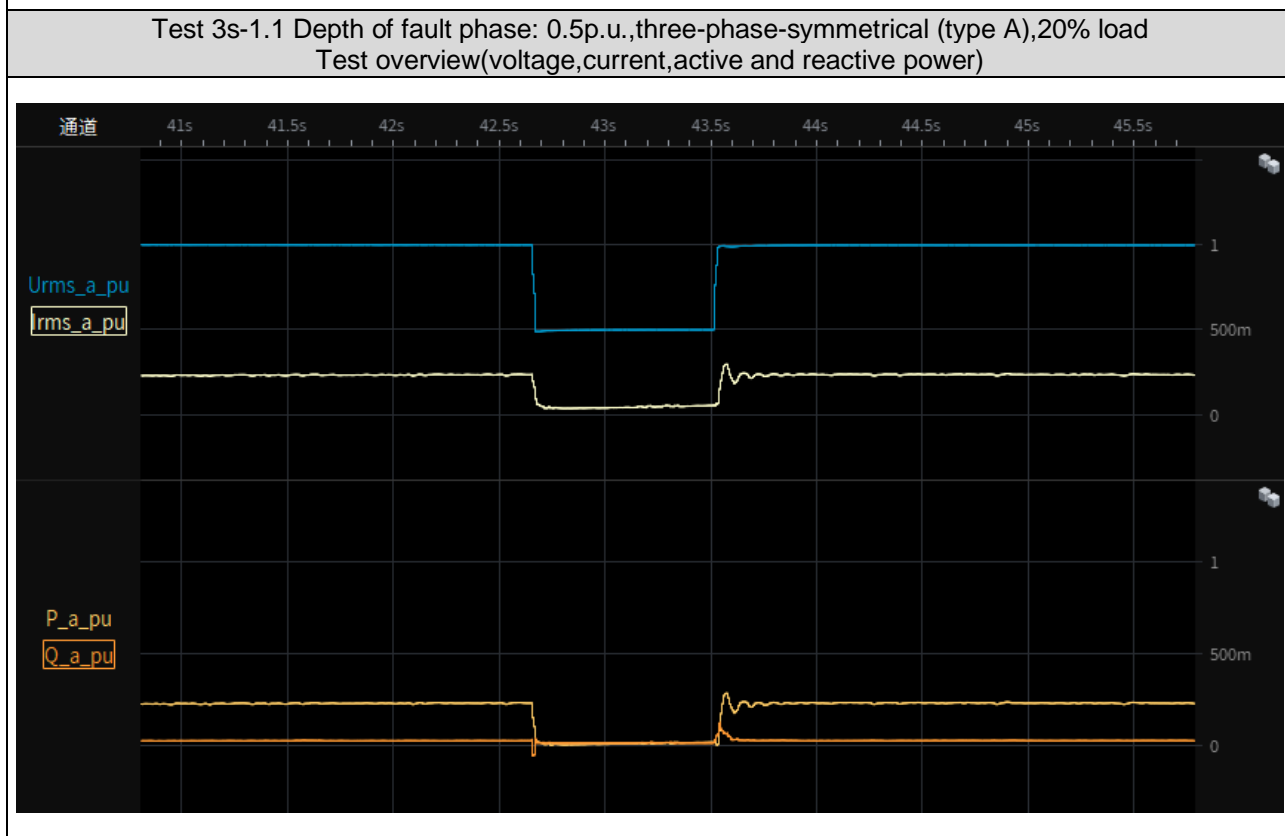
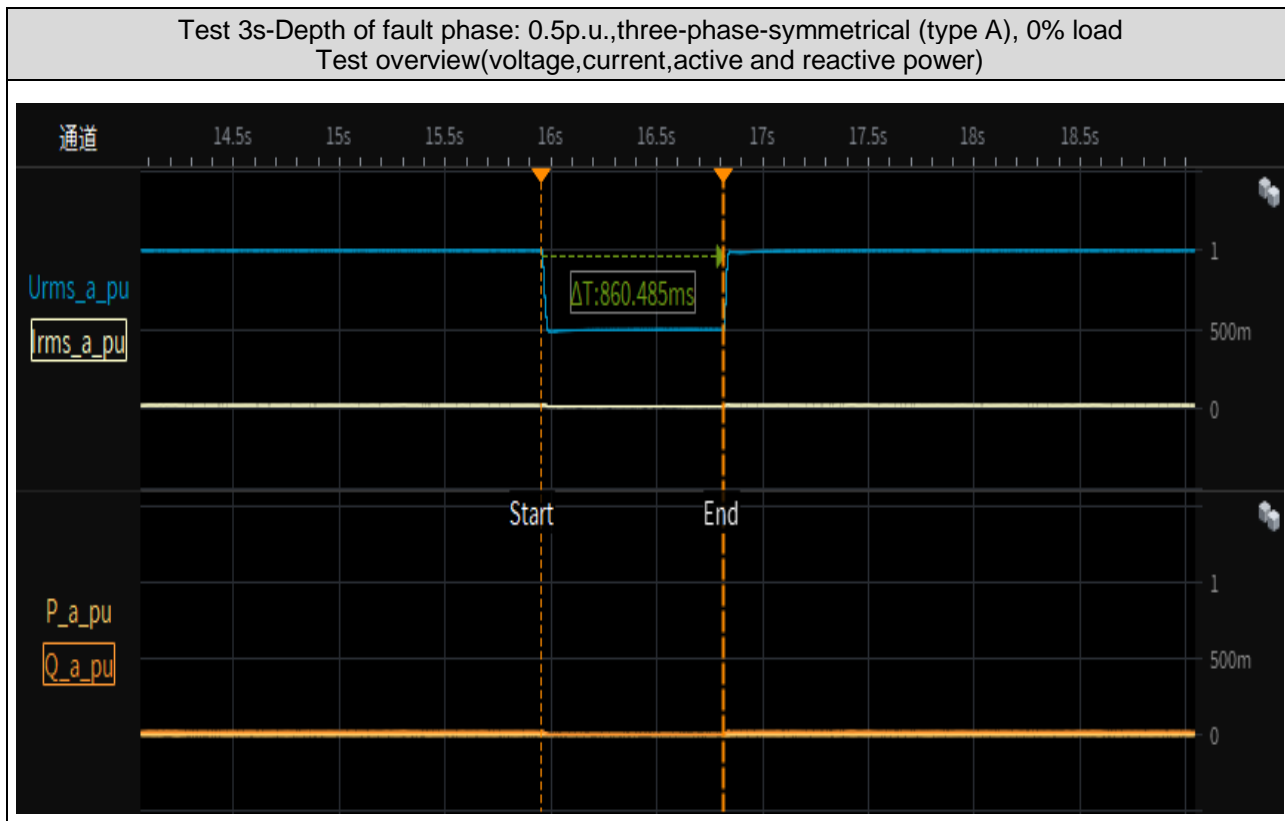

CEI 0-21			
Clause	Requirement - Test	Result - Remark	Verdict

Test 3s-1.2 Depth of fault phase: 0.5p.u.,three-phase-symmetrical (type A),20% load
Instantaneous curve and RMS value of phase-to-neutral voltages

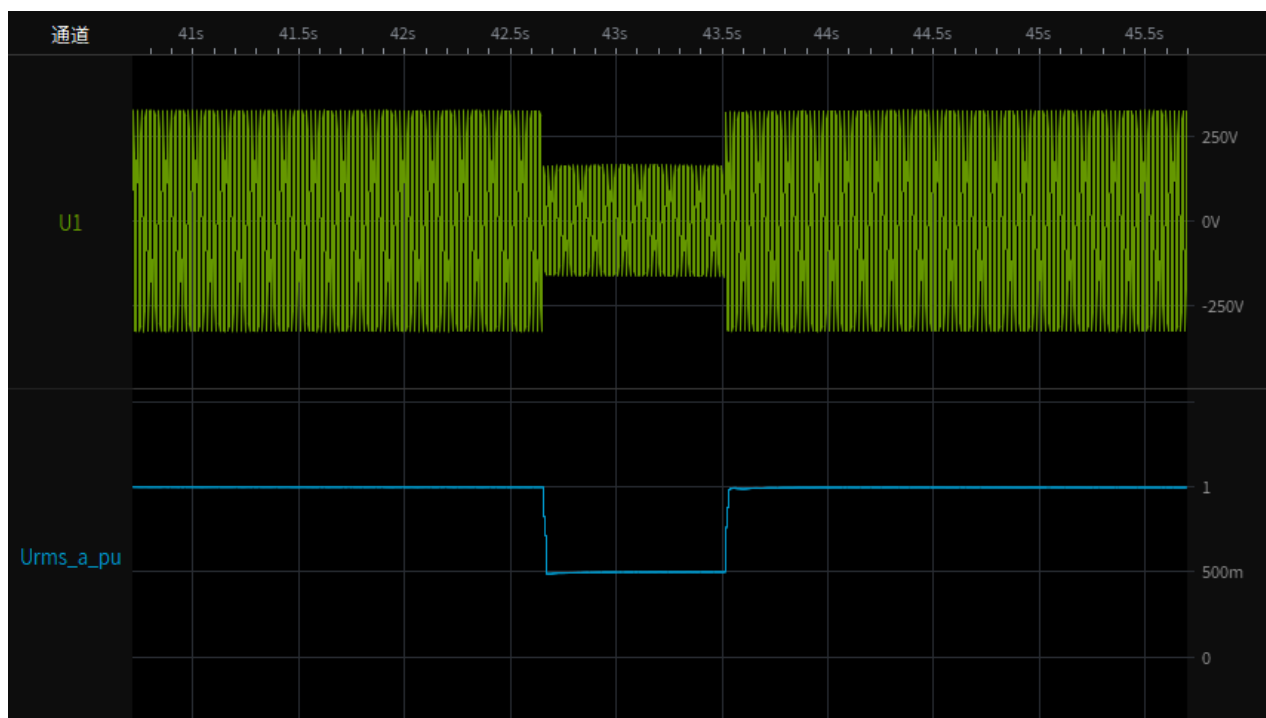

Test 3s-1.3 Depth of fault phase: 0.5p.u.,three-phase-symmetrical (type A),20% load
Instantaneous curve and RMS value of phase currents

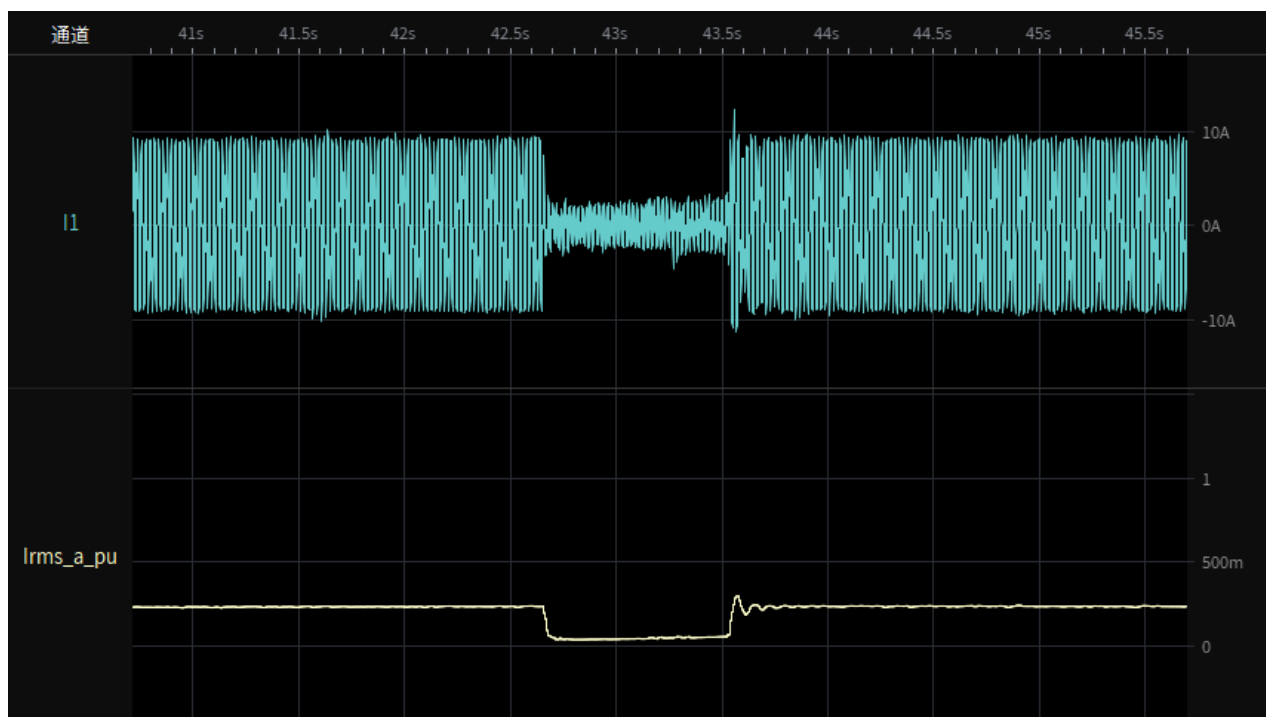

CEI 0-21			
Clause	Requirement - Test	Result - Remark	Verdict

Test 3s-1.4 Depth of fault phase: 0.5p.u.,three-phase-symmetrical (type A),20% load restoring time

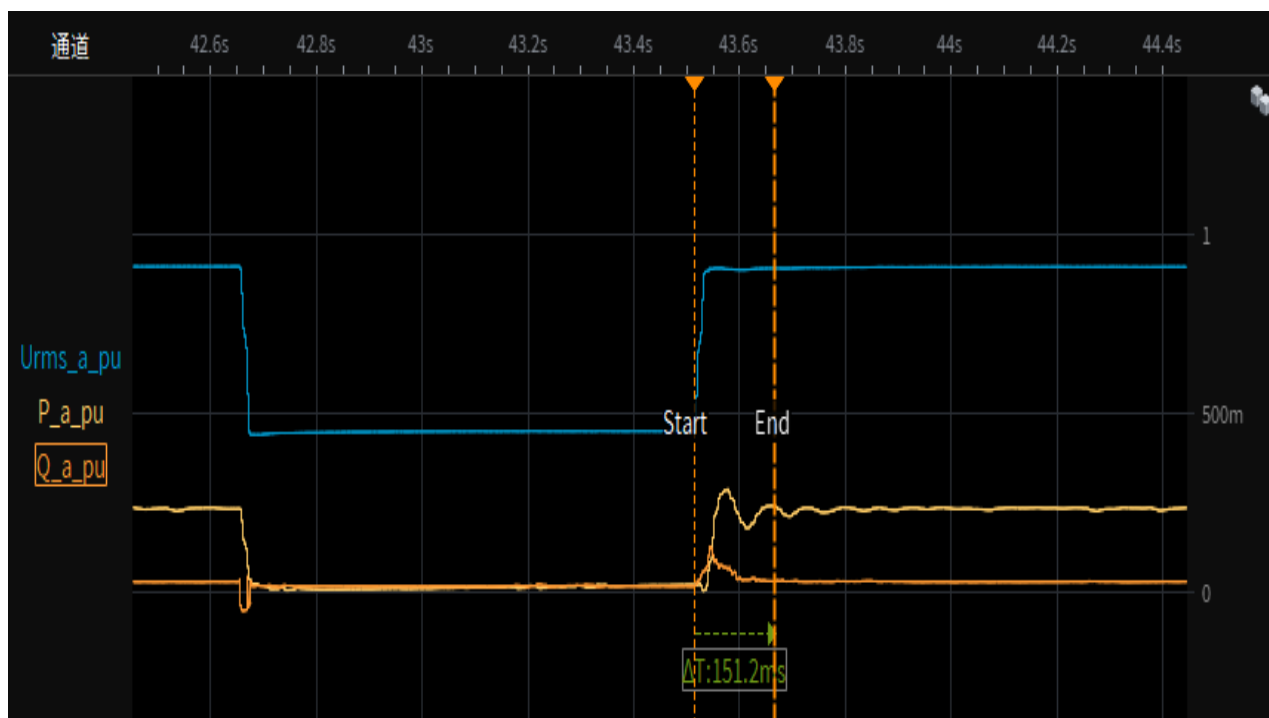

Test 3s-2.1 Depth of fault phase: 0.5p.u.,three-phase-symmetrical (type A),95% load Test overview(voltage,current,active and reactive power)

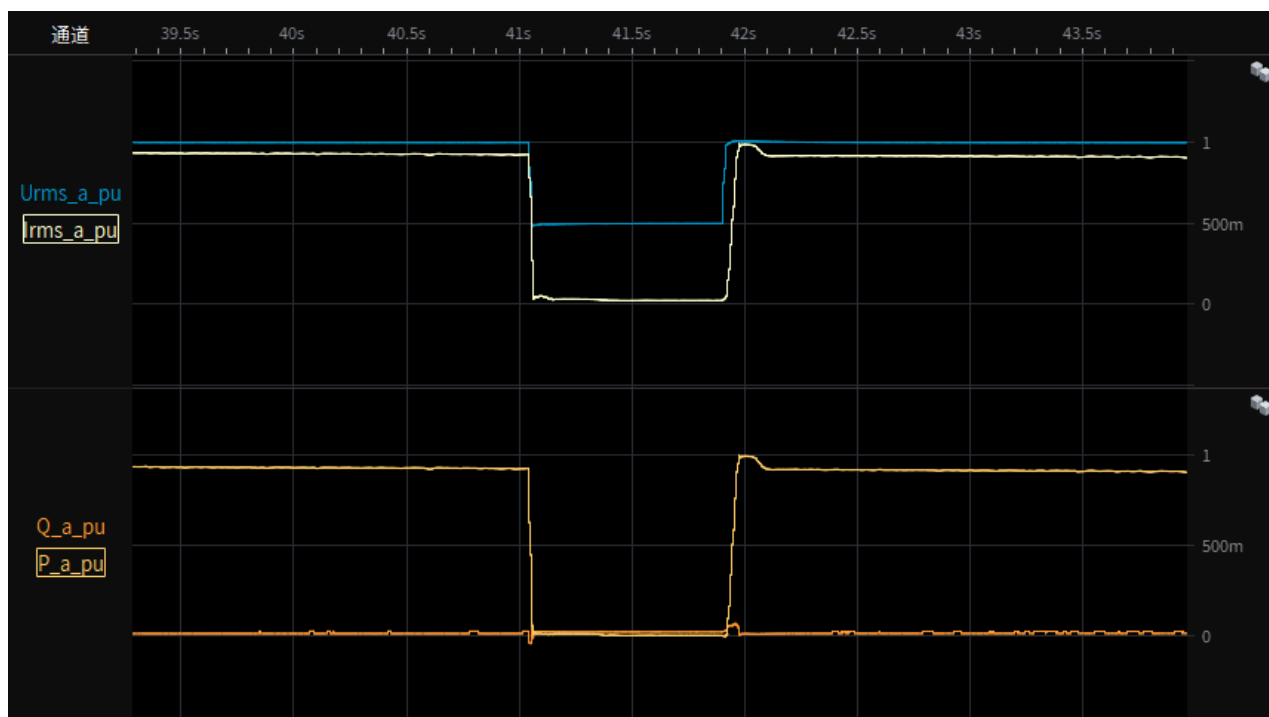

CEI 0-21			
Clause	Requirement - Test	Result - Remark	Verdict

Test 3s-2.2 Depth of fault phase: 0.5p.u.,three-phase-symmetrical (type A),95% load
Instantaneous curve and RMS value of phase-to-neutral voltages

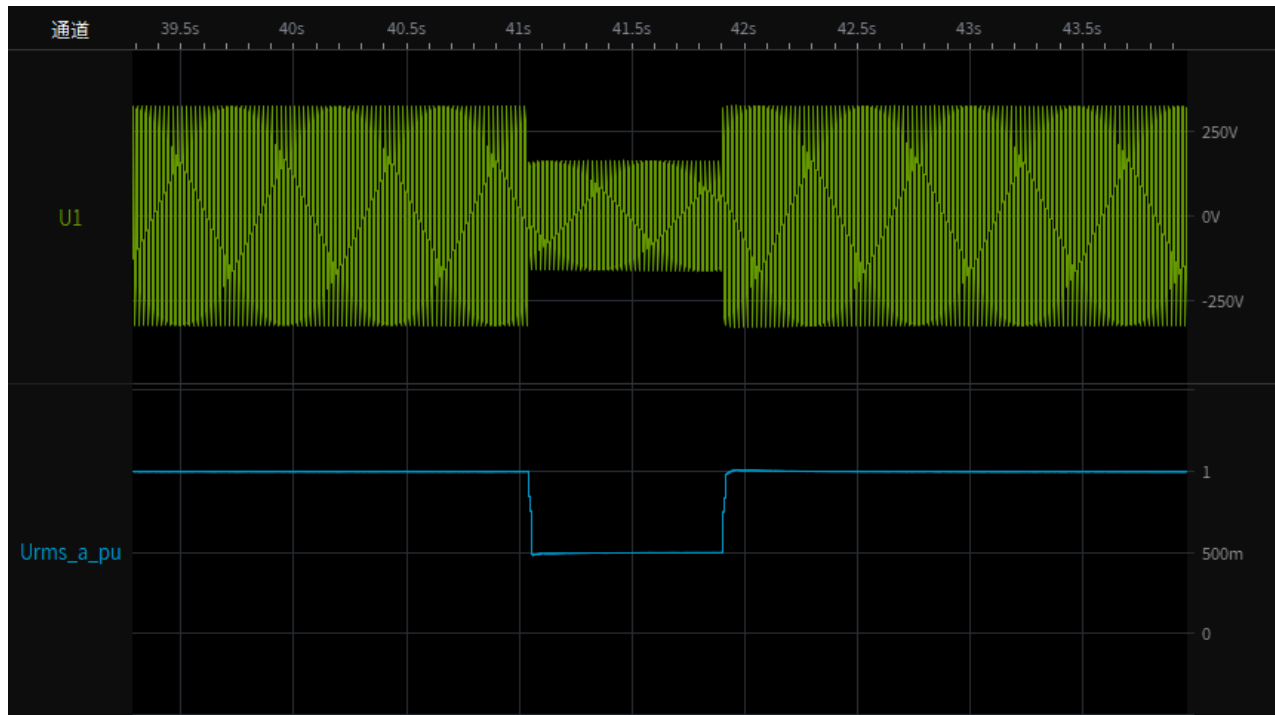

Test 3s-2.3 Depth of fault phase: 0.5p.u.,three-phase-symmetrical (type A),95% load
Instantaneous curve and RMS value of phase currents

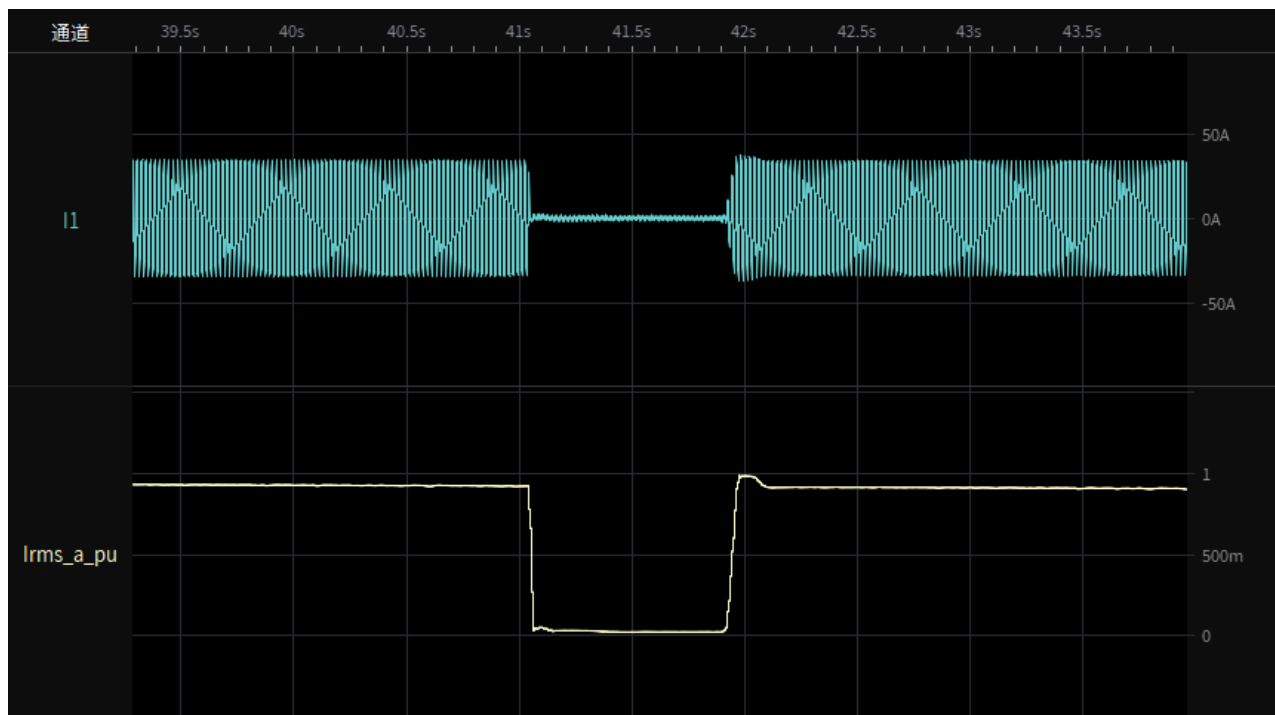

CEI 0-21			
Clause	Requirement - Test	Result - Remark	Verdict

Test 3s-2.4 Depth of fault phase: 0.5p.u.,three-phase-symmetrical (type A), 95% load restoring time

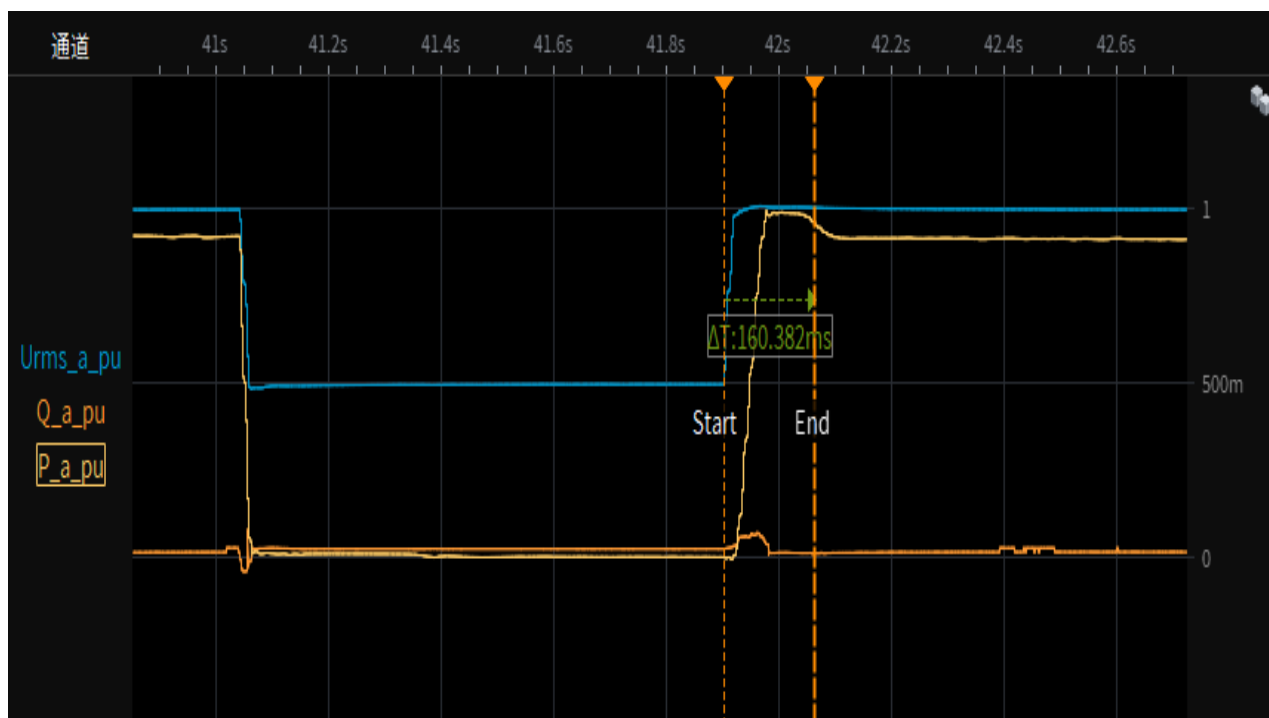

Test 3a-Depth of fault phase: 0.5p.u.,two-phase-asymmetrical (type D), 0% load Test overview(voltage,current,active and reactive power)

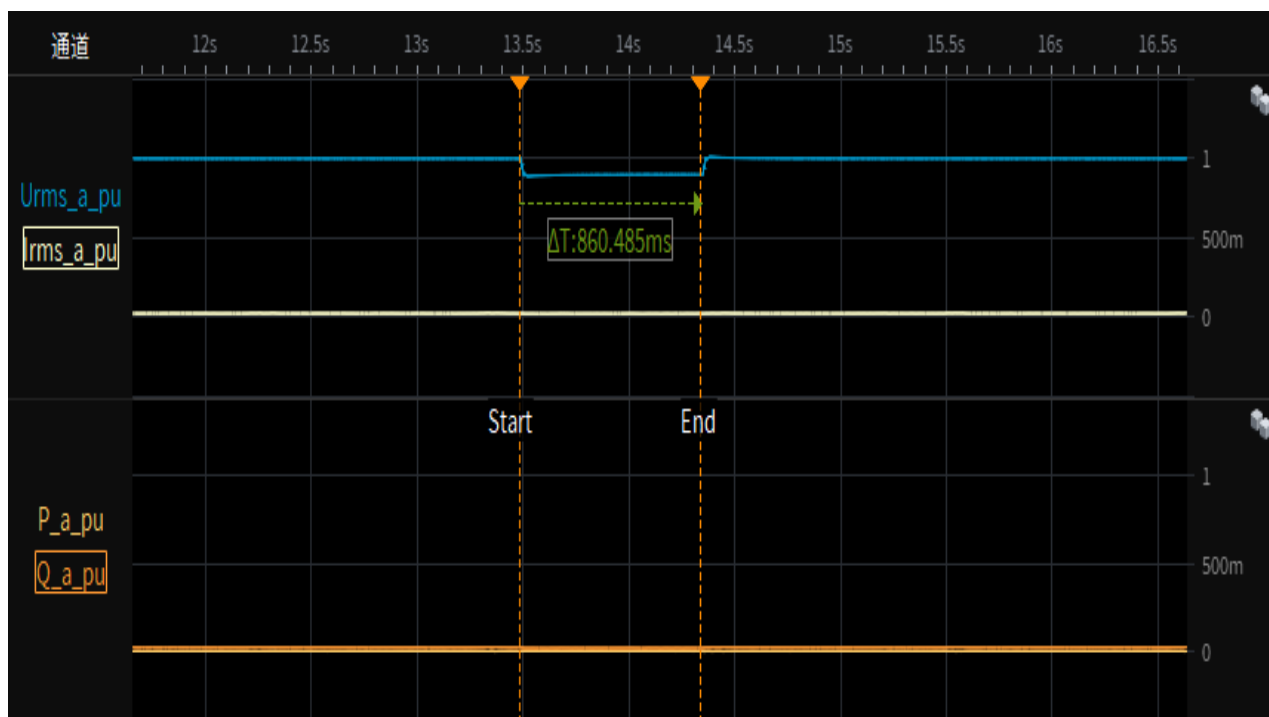

CEI 0-21			
Clause	Requirement - Test	Result - Remark	Verdict

Test 3a-1.1 Depth of fault phase: 0.5p.u.,two-phase-asymmetrical (type D),20% load
Test overview(voltage,current,active and reactive power)

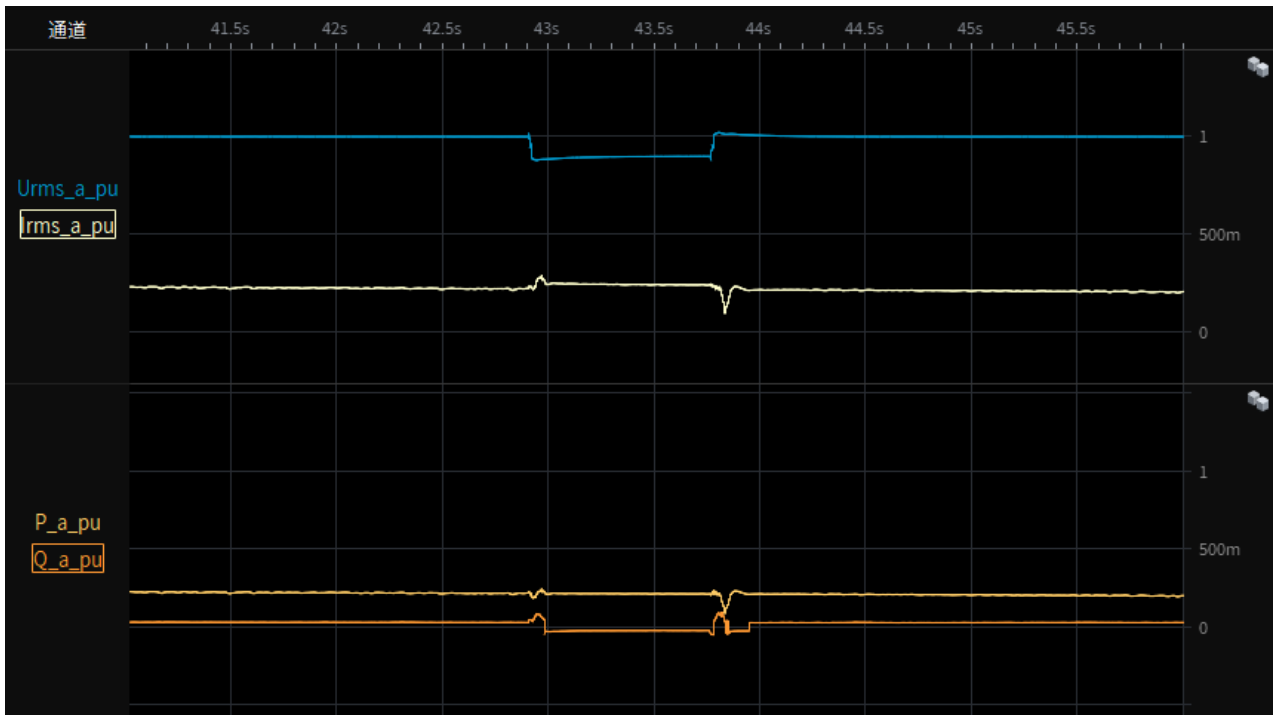

Test 3a-1.2 Depth of fault phase: 0.5p.u.,two-phase-asymmetrical (type D),20% load
Instantaneous curve and RMS value of phase-to-neutral voltages

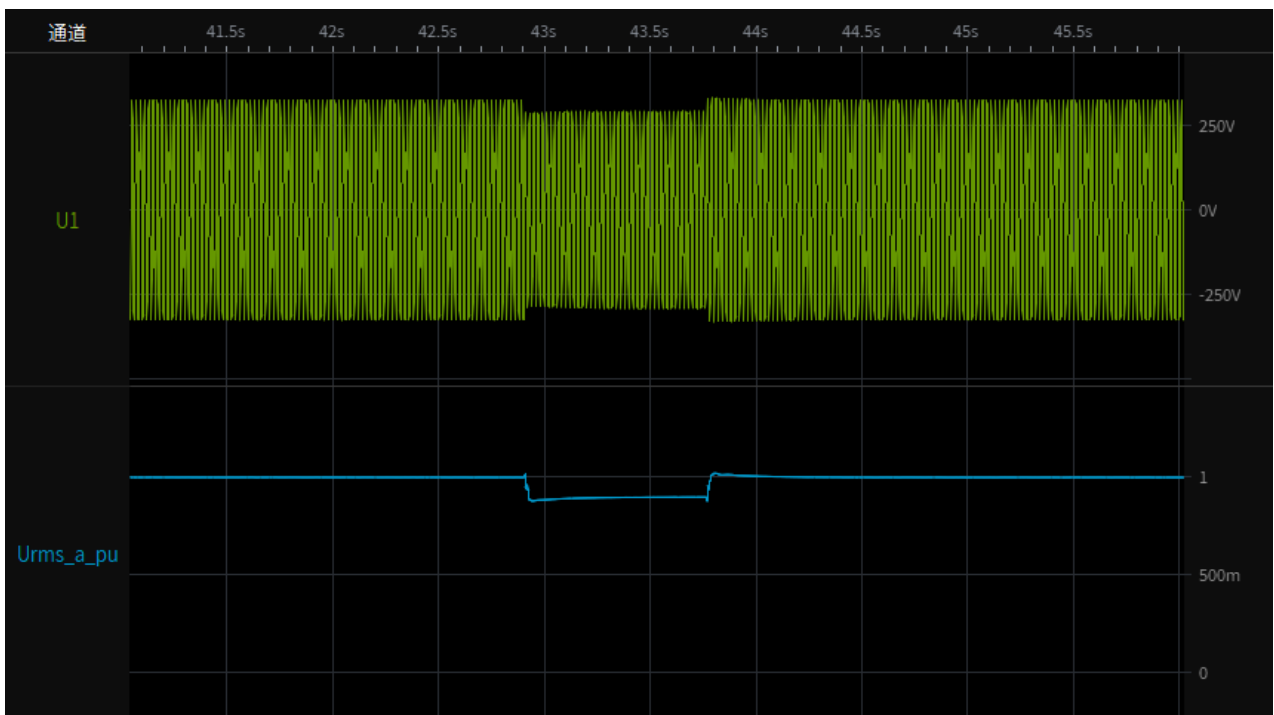

CEI 0-21			
Clause	Requirement - Test	Result - Remark	Verdict

Test 3a-1.3 Depth of fault phase: 0.5p.u.,two-phase-asymmetrical (type D),20% load
Instantaneous curve and RMS value of phase currents

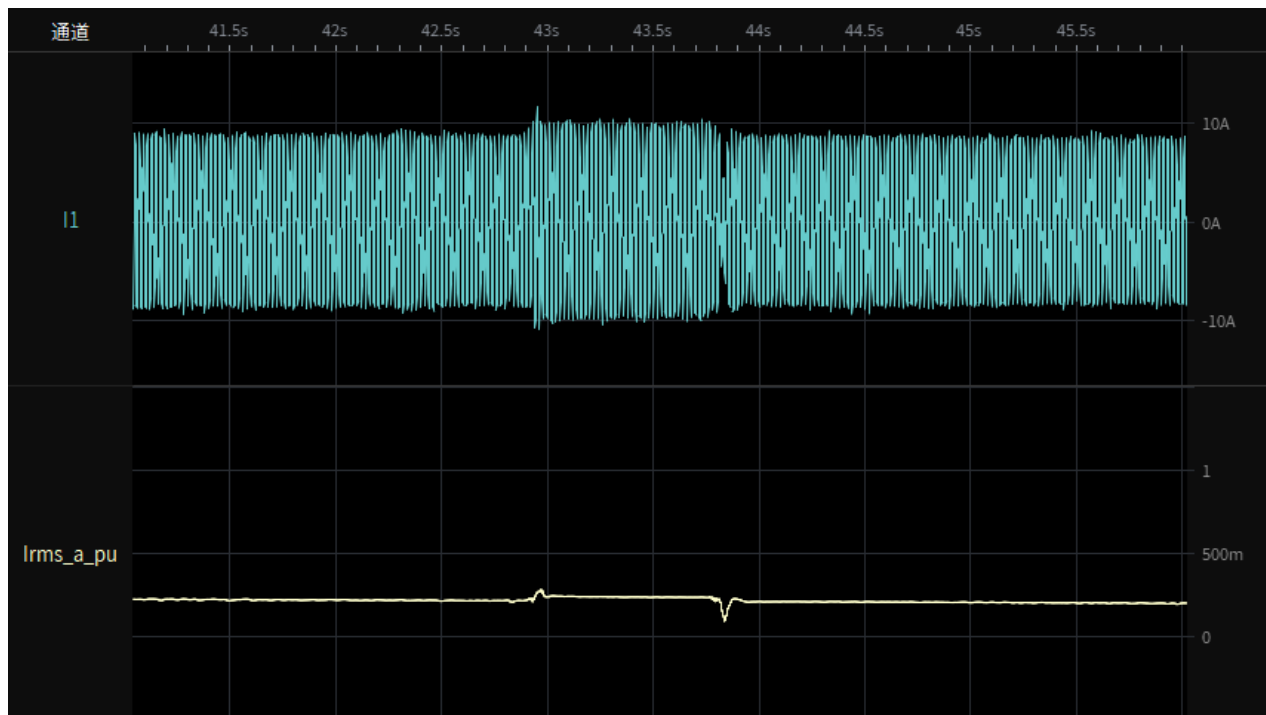

Test 3a-1.4 Depth of fault phase: 0.5p.u.,two-phase-asymmetrical (type D),20% load
restoring time

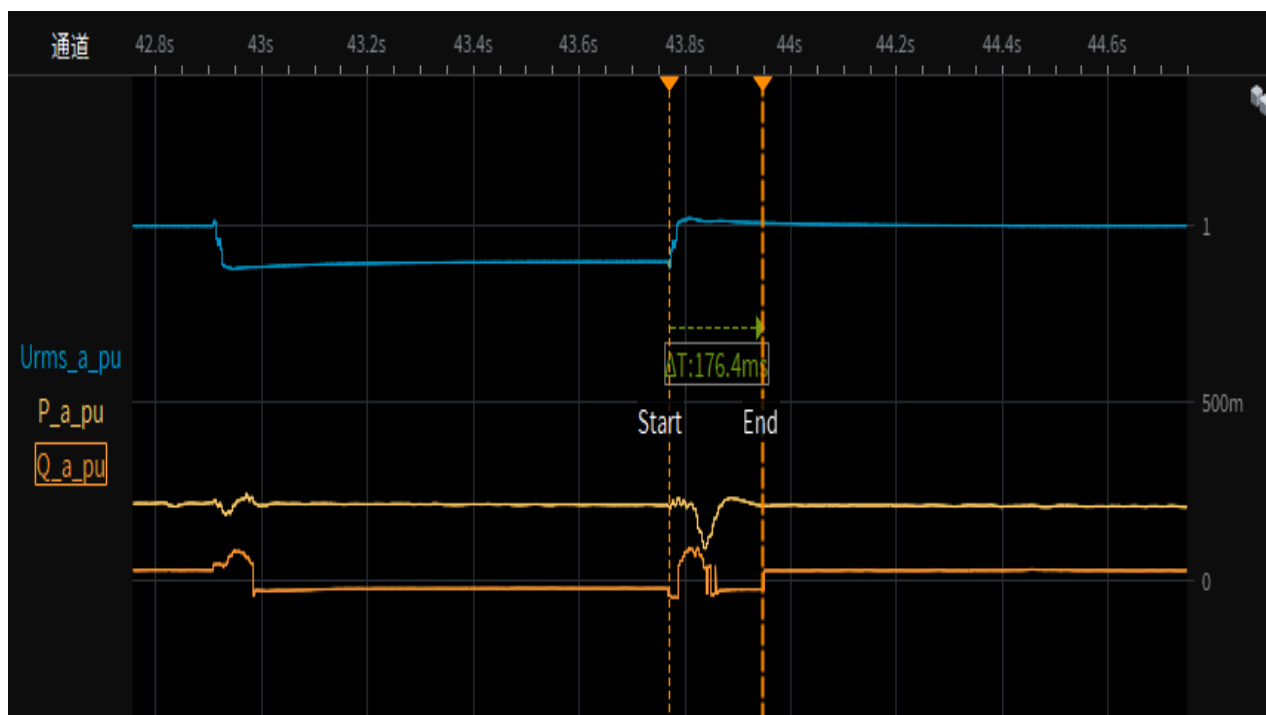

CEI 0-21			
Clause	Requirement - Test	Result - Remark	Verdict

Test 3a-2.1 Depth of fault phase: 0.5p.u.,two-phase-asymmetrical (type D),95% load
Test overview(voltage,current,active and reactive power)

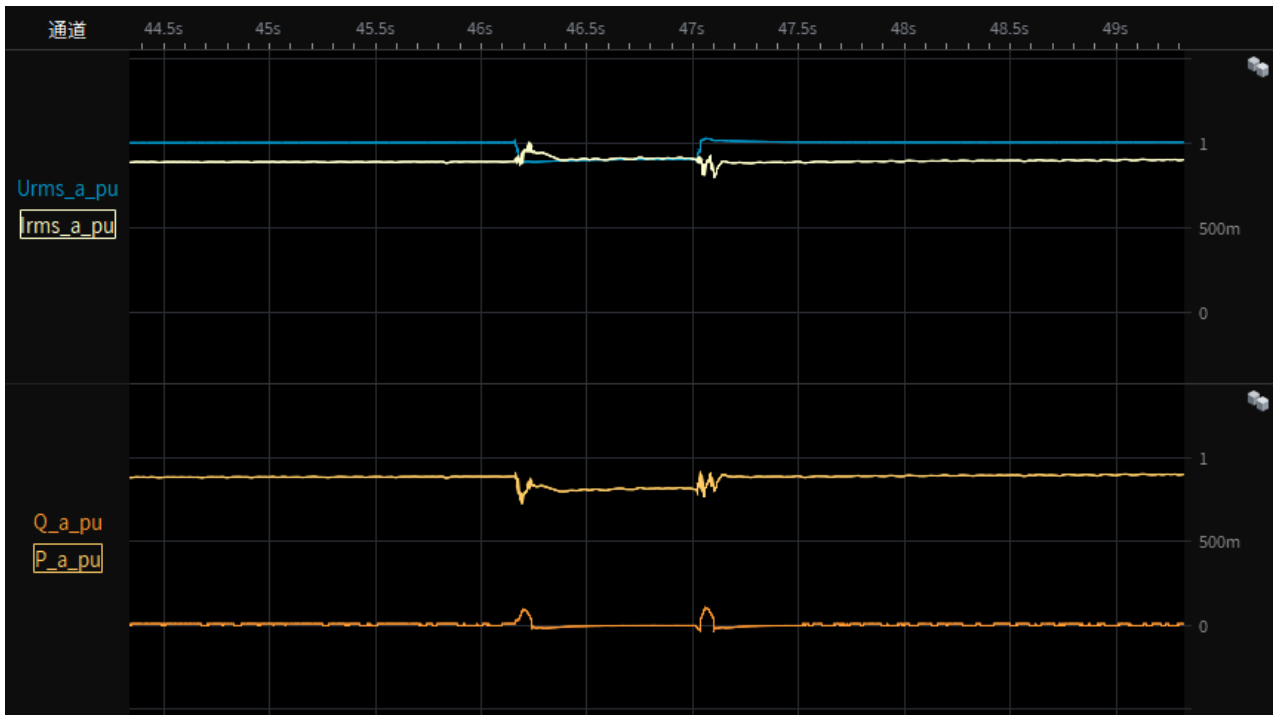

Test 3a-2.2 Depth of fault phase: 0.5p.u.,two-phase-asymmetrical (type D),95% load
Instantaneous curve and RMS value of phase-to-neutral voltages

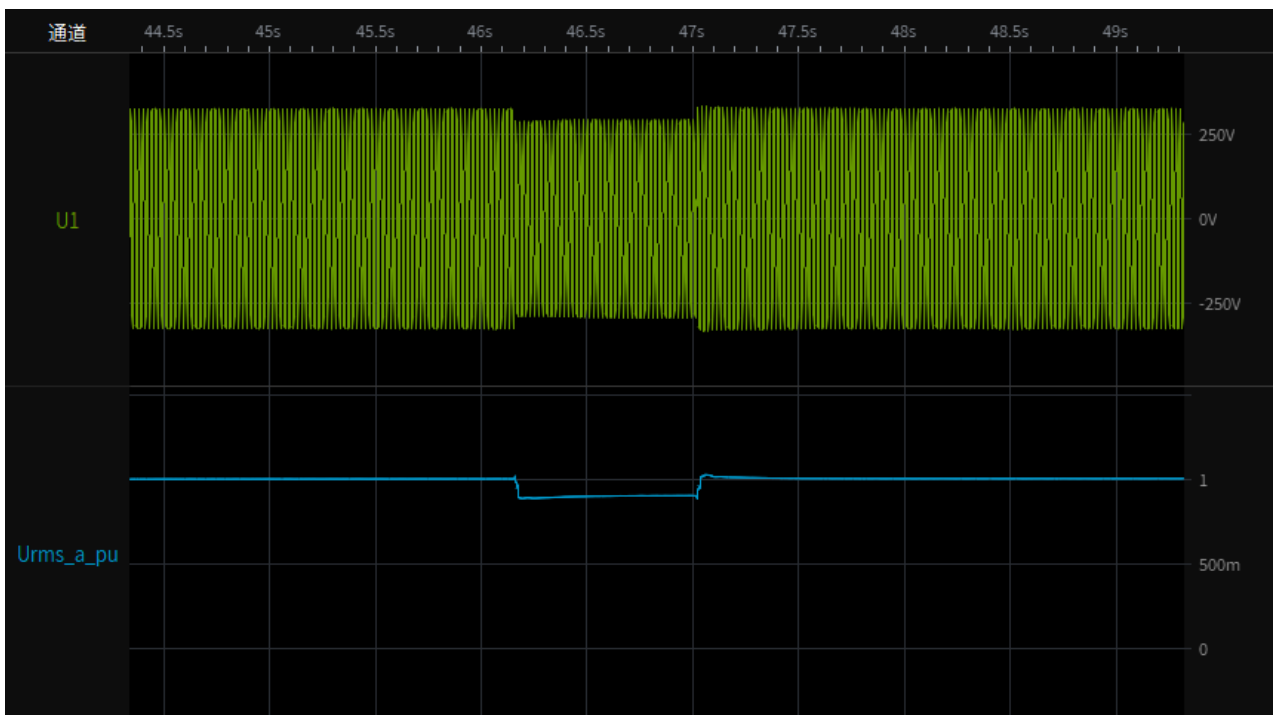

CEI 0-21			
Clause	Requirement - Test	Result - Remark	Verdict

Test 3a-2.3 Depth of fault phase: 0.5p.u.,two-phase-asymmetrical (type D),95% load
Instantaneous curve and RMS value of phase currents

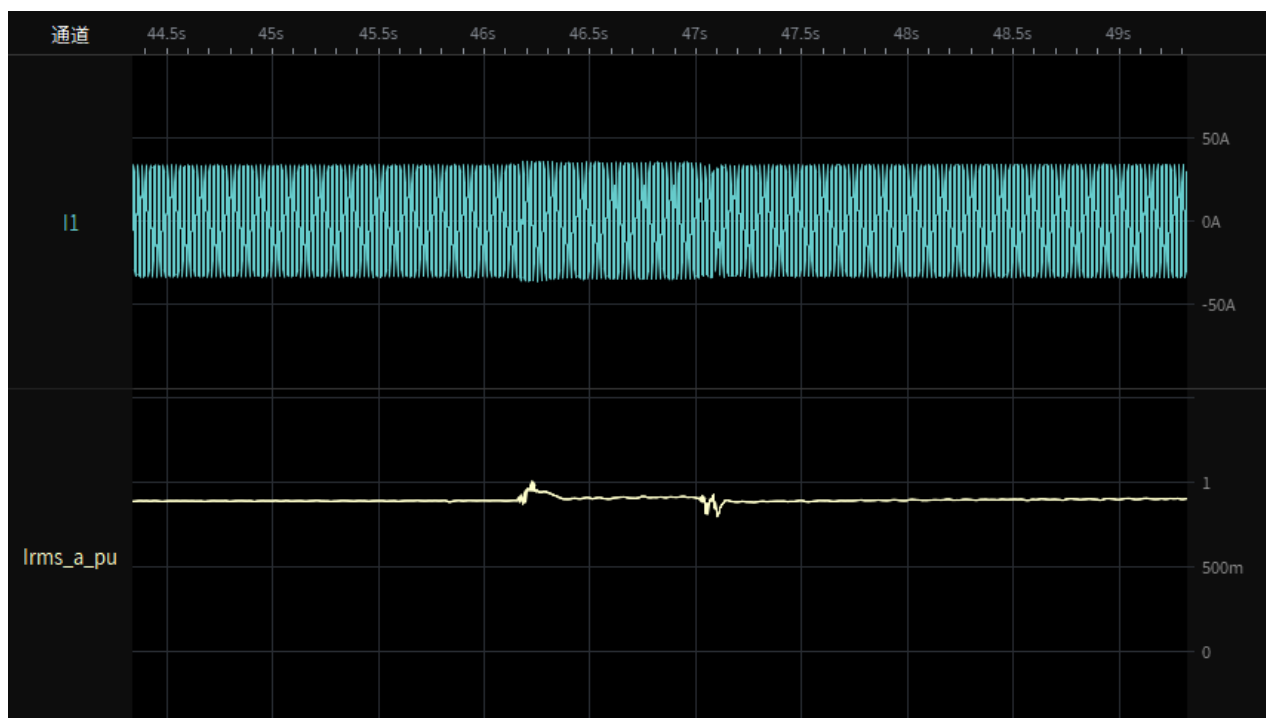

Test 3a-2.4 Depth of fault phase: 0.5p.u.,two-phase-asymmetrical (type D), 95% load
restoring time

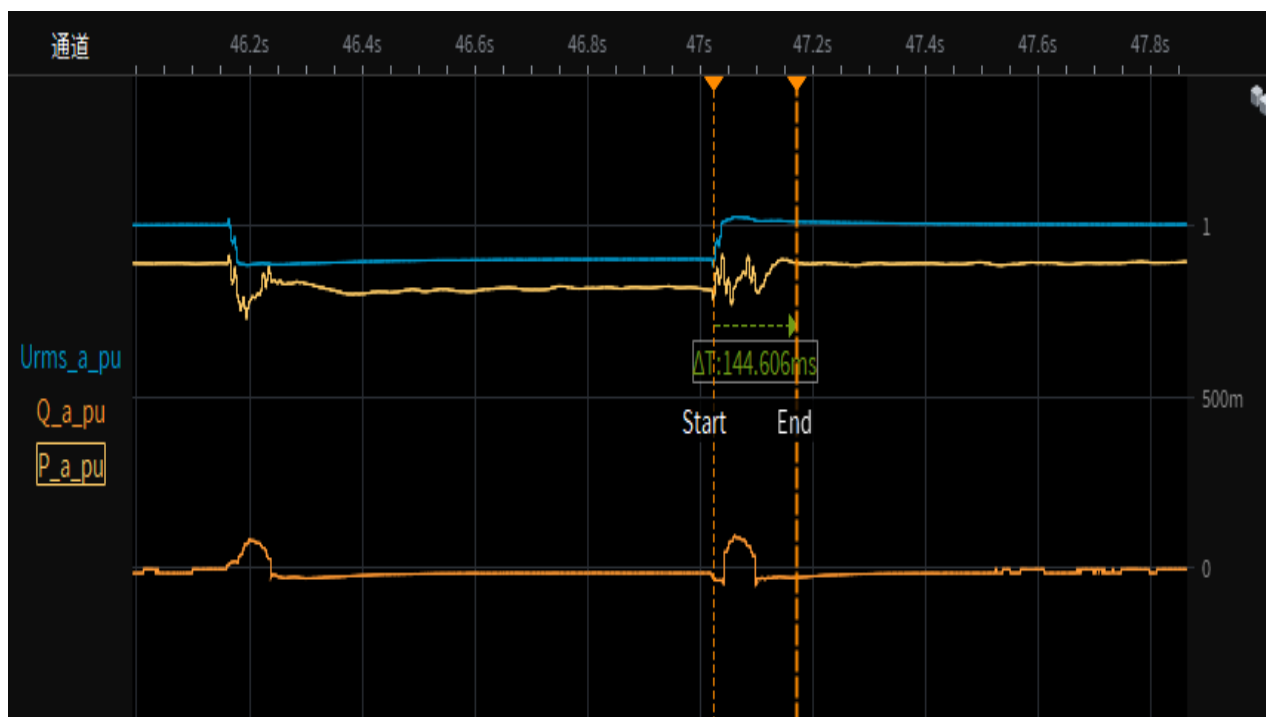

CEI 0-21			
Clause	Requirement - Test	Result - Remark	Verdict

Test 4s-Depth of fault phase: 0.75p.u.,three-phase-symmetrical (type A), 0% load
Test overview(voltage,current,active and reactive power)

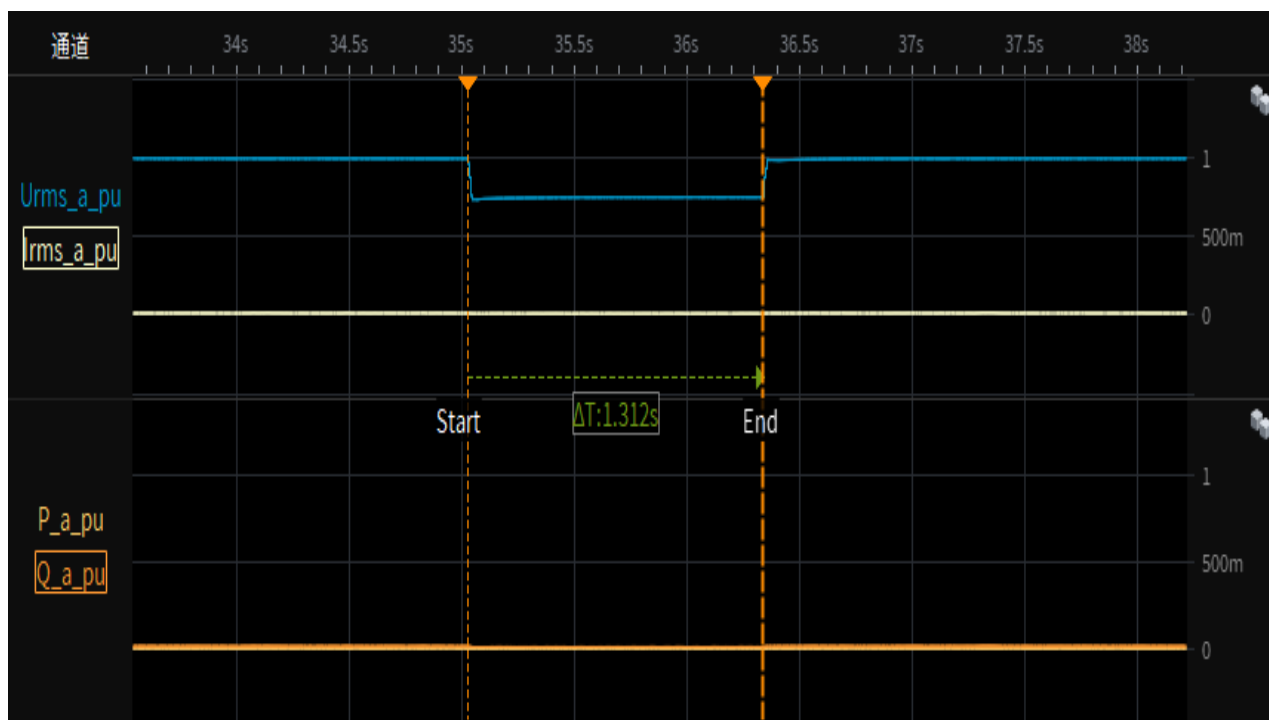

Test 4s-1.1 Depth of fault phase: 0.75p.u.,three-phase-symmetrical (type A),20% load
Test overview(voltage,current,active and reactive power)

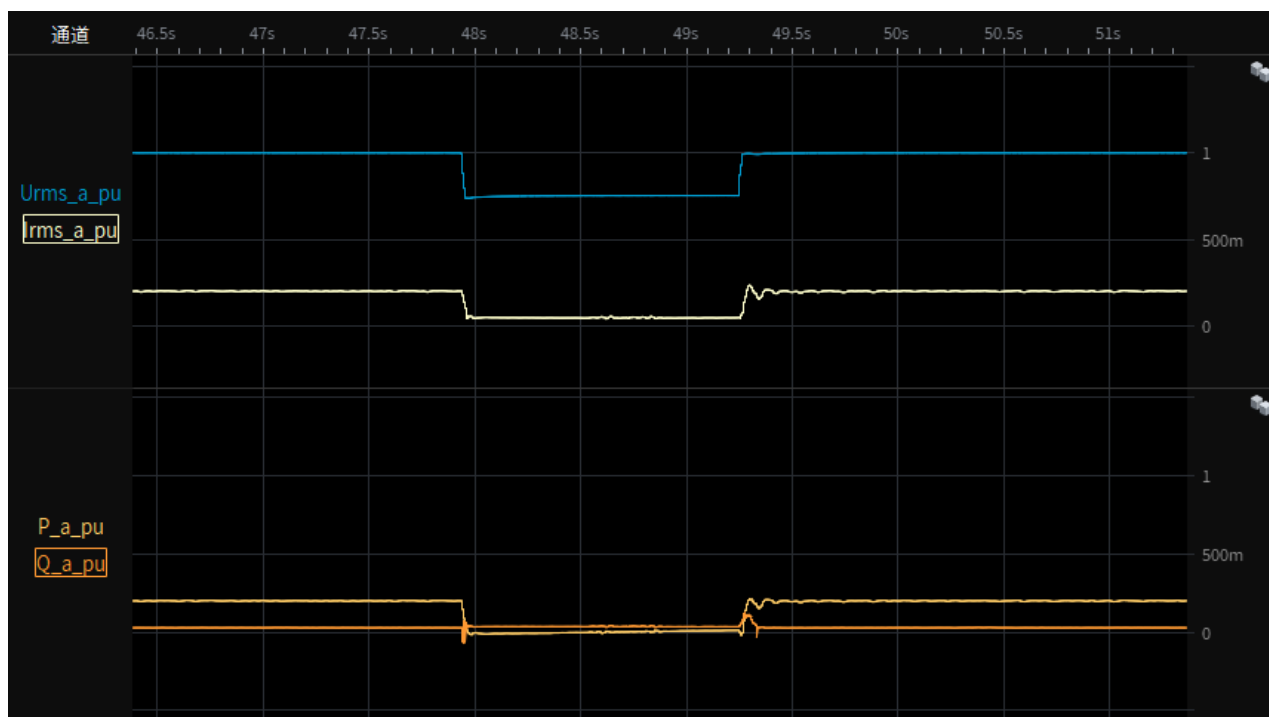

CEI 0-21			
Clause	Requirement - Test	Result - Remark	Verdict

Test 4s-1.2 Depth of fault phase: 0.75p.u.,three-phase-symmetrical (type A),20% load
Instantaneous curve and RMS value of phase-to-neutral voltages

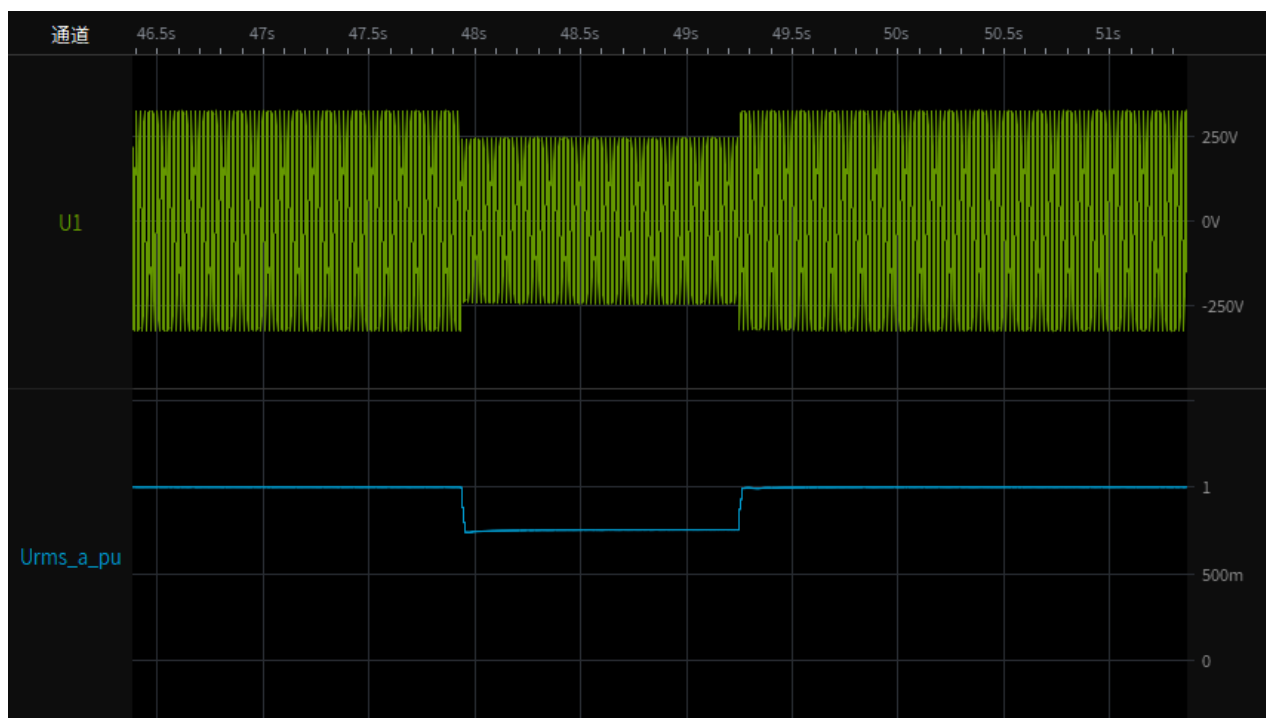

Test 4s-1.3 Depth of fault phase: 0.75p.u.,three-phase-symmetrical (type A),20% load
Instantaneous curve and RMS value of phase currents

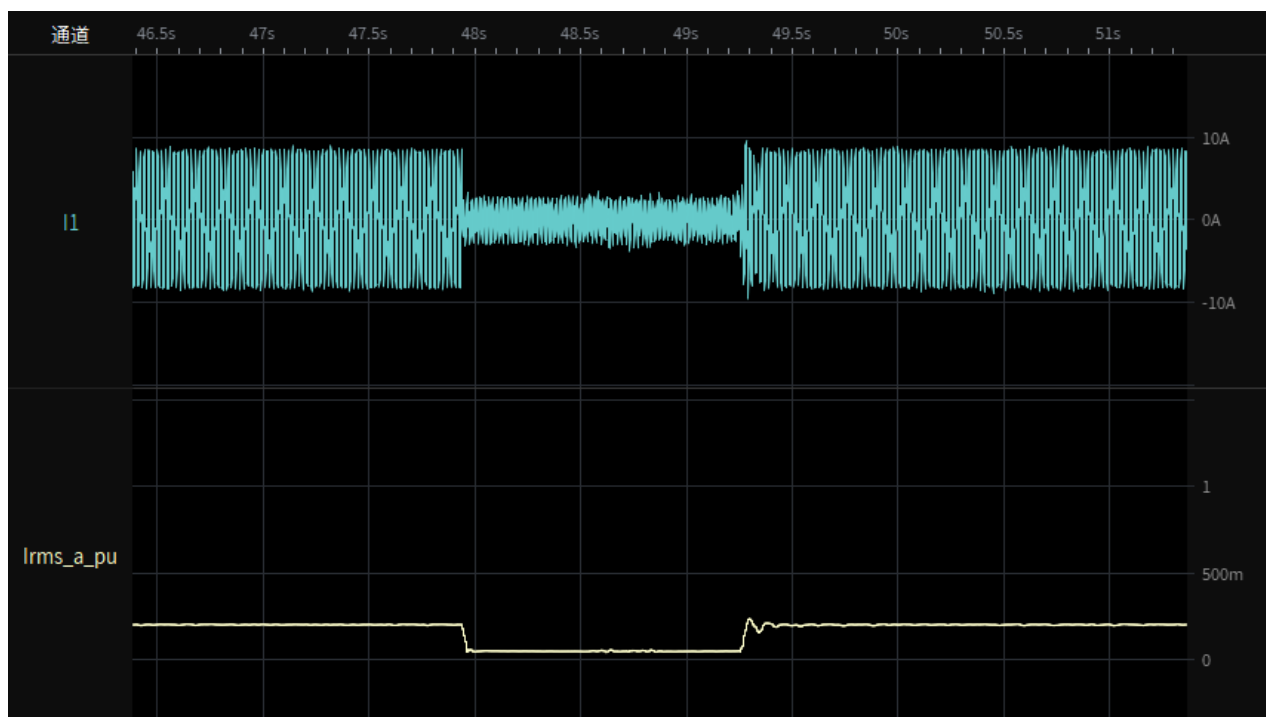

CEI 0-21			
Clause	Requirement - Test	Result - Remark	Verdict

Test 4s-1.4 Depth of fault phase: 0.75p.u.,three-phase-symmetrical (type A),20% load restoring time

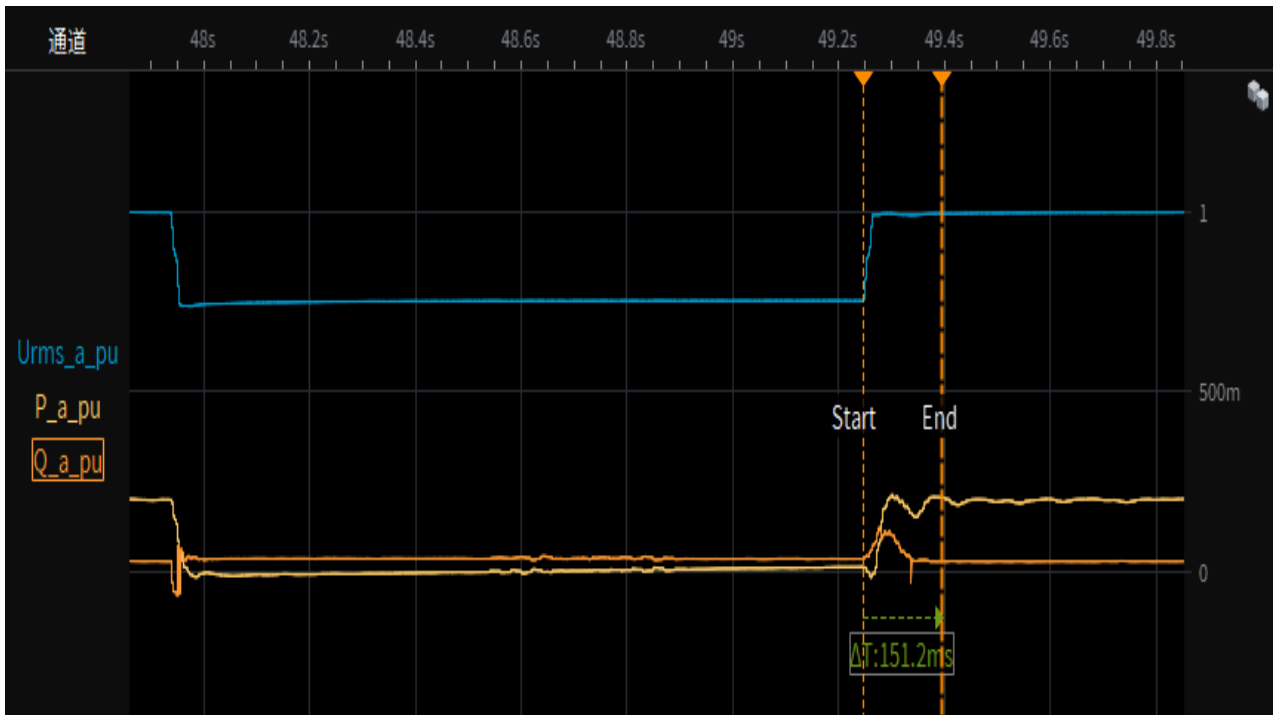

Test 4s-2.1 Depth of fault phase: 0.75p.u.,three-phase-symmetrical (type A),95% load Test overview(voltage,current,active and reactive power)

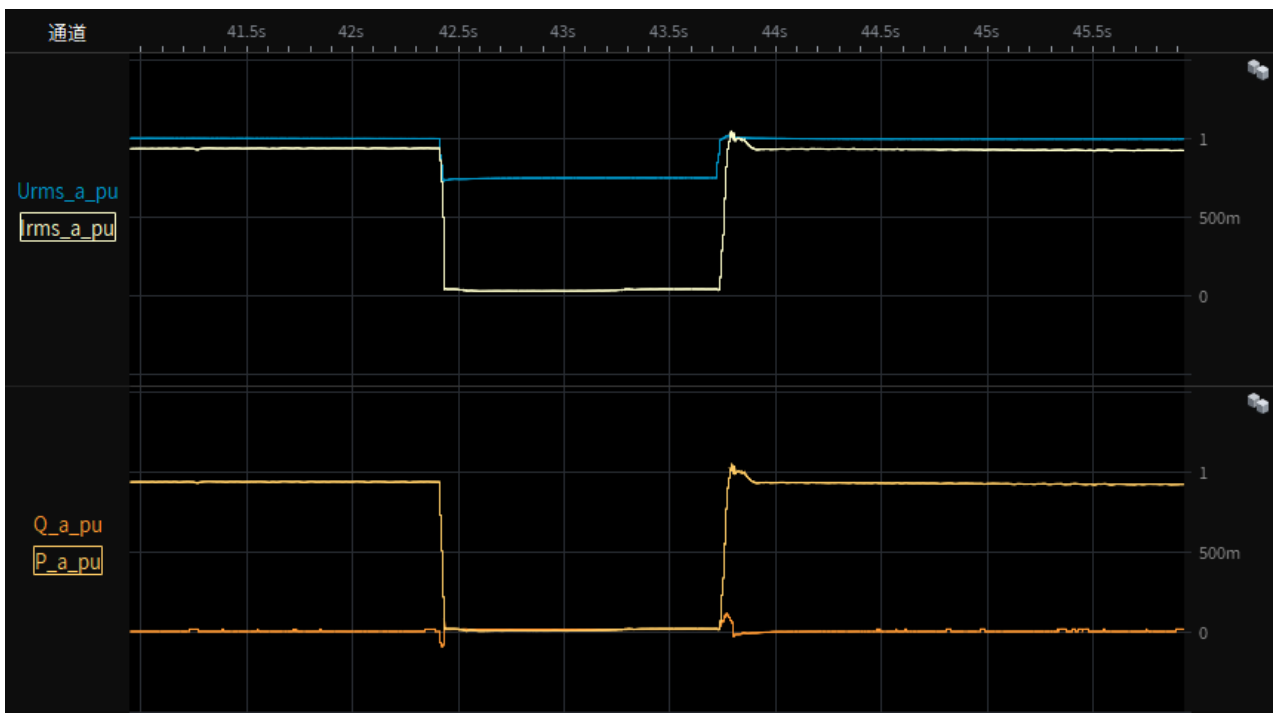

CEI 0-21			
Clause	Requirement - Test	Result - Remark	Verdict

Test 4s-2.2 Depth of fault phase: 0.75p.u.,three-phase-symmetrical (type A),95% load
Instantaneous curve and RMS value of phase-to-neutral voltages

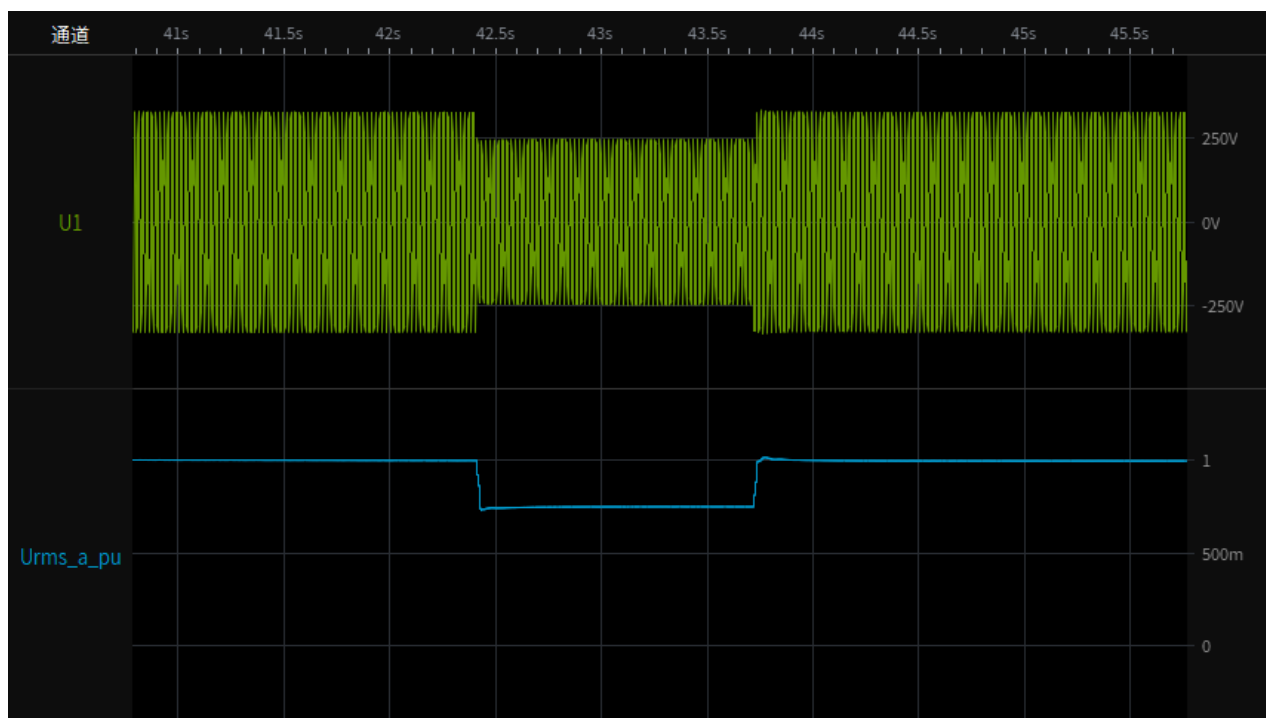

Test 4s-2.3 Depth of fault phase: 0.75p.u.,three-phase-symmetrical (type A),95% load
Instantaneous curve and RMS value of phase currents

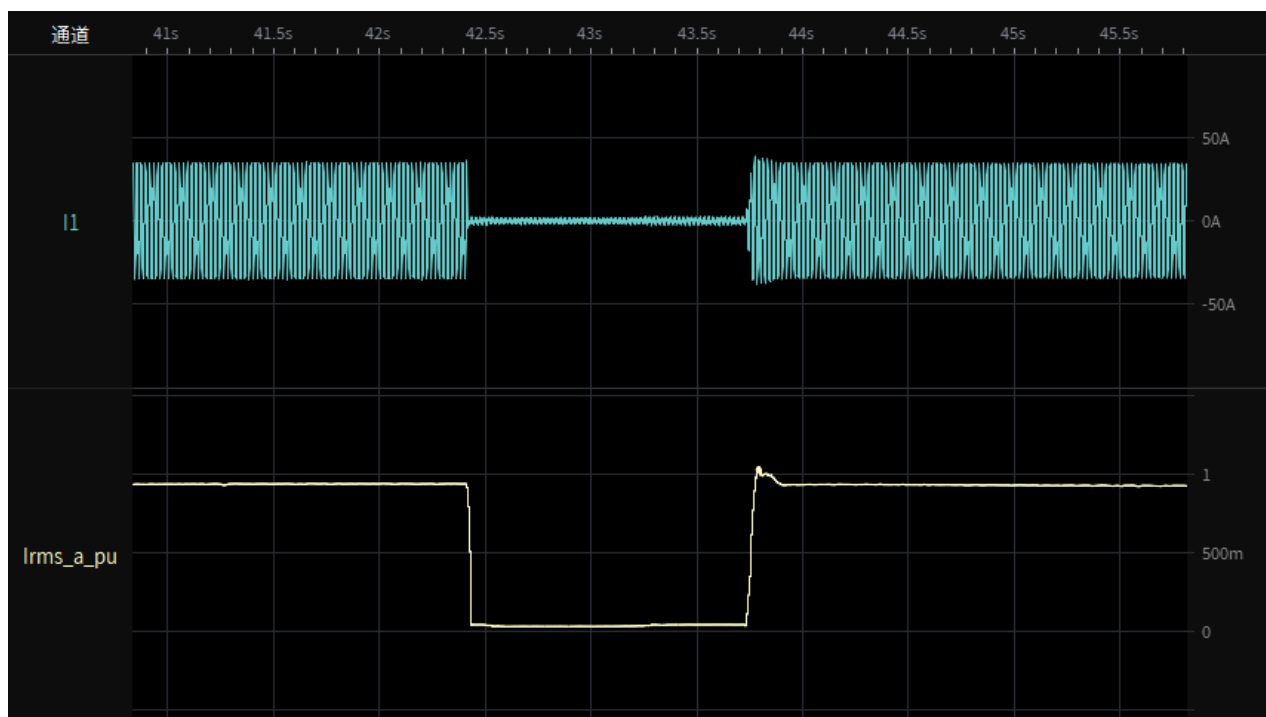

CEI 0-21			
Clause	Requirement - Test	Result - Remark	Verdict

Test 4s-2.4 Depth of fault phase: 0.75p.u.,three-phase-symmetrical (type A), 95% load restoring time



Test 4a-Depth of fault phase: 0.75p.u.,two-phase-asymmetrical (type D), 0% load Test overview(voltage,current,active and reactive power)

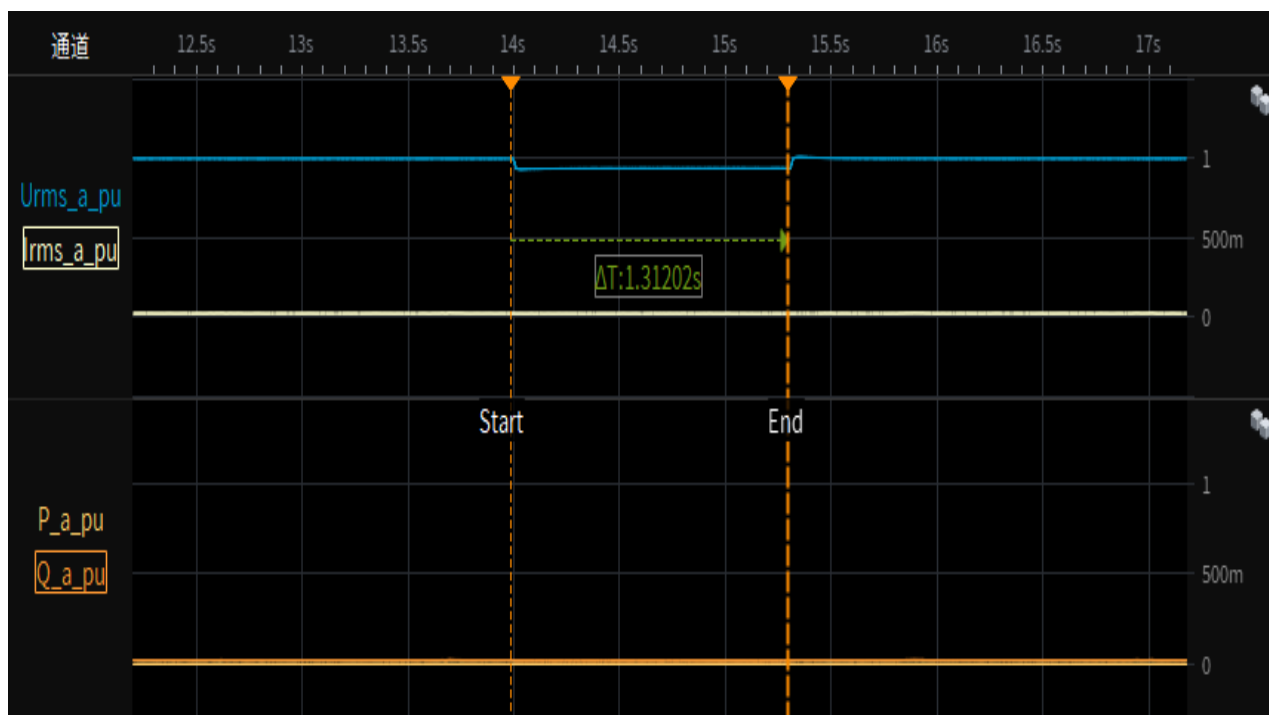

CEI 0-21			
Clause	Requirement - Test	Result - Remark	Verdict

Test 4a-1.1 Depth of fault phase: 0.75p.u.,two-phase-asymmetrical (type D),20% load
Test overview(voltage,current,active and reactive power)

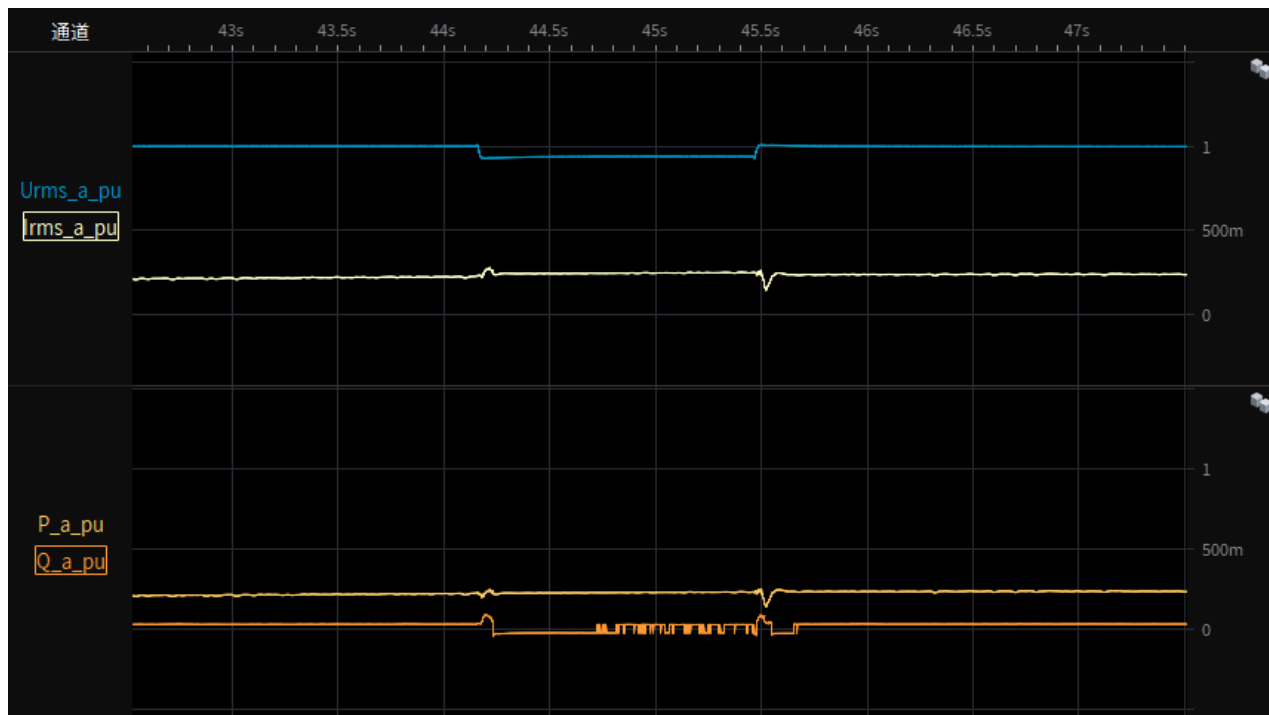

Test 4a-1.2 Depth of fault phase: 0.75p.u.,two-phase-asymmetrical (type D),20% load
Instantaneous curve and RMS value of phase-to-neutral voltages

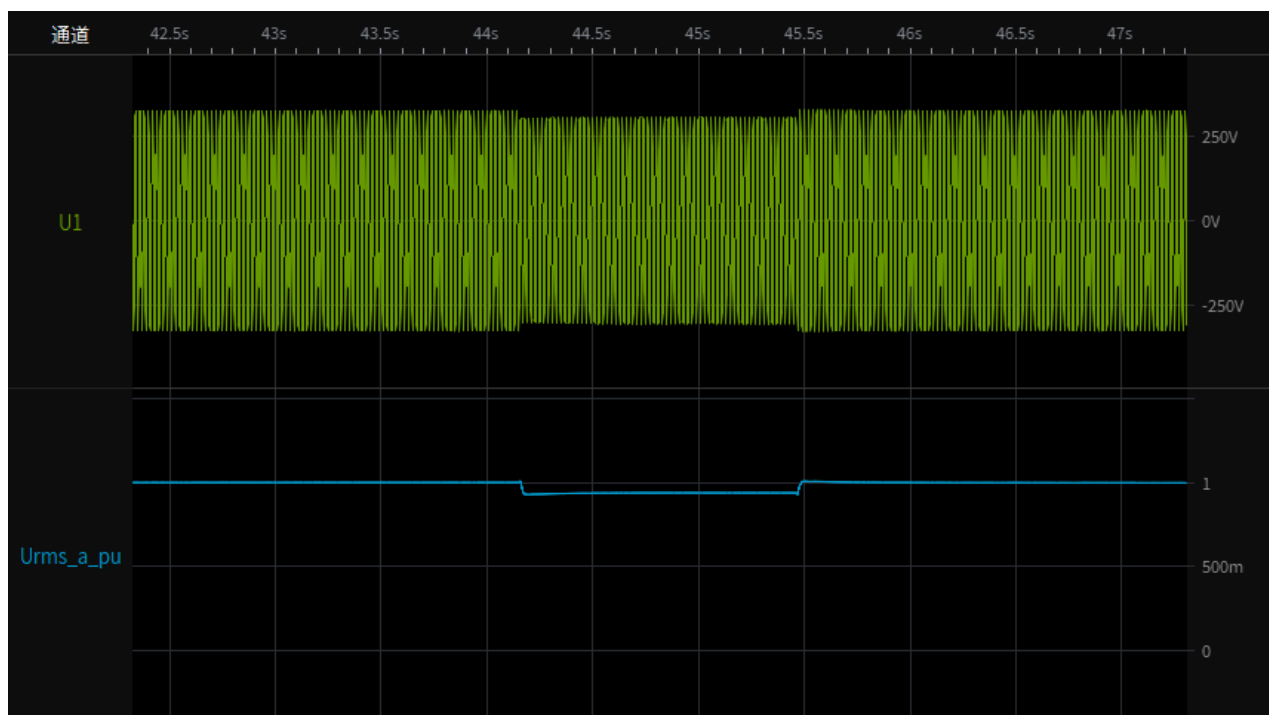

CEI 0-21			
Clause	Requirement - Test	Result - Remark	Verdict

Test 4a-1.3 Depth of fault phase: 0.75p.u.,two-phase-asymmetrical (type D),20% load
Instantaneous curve and RMS value of phase currents

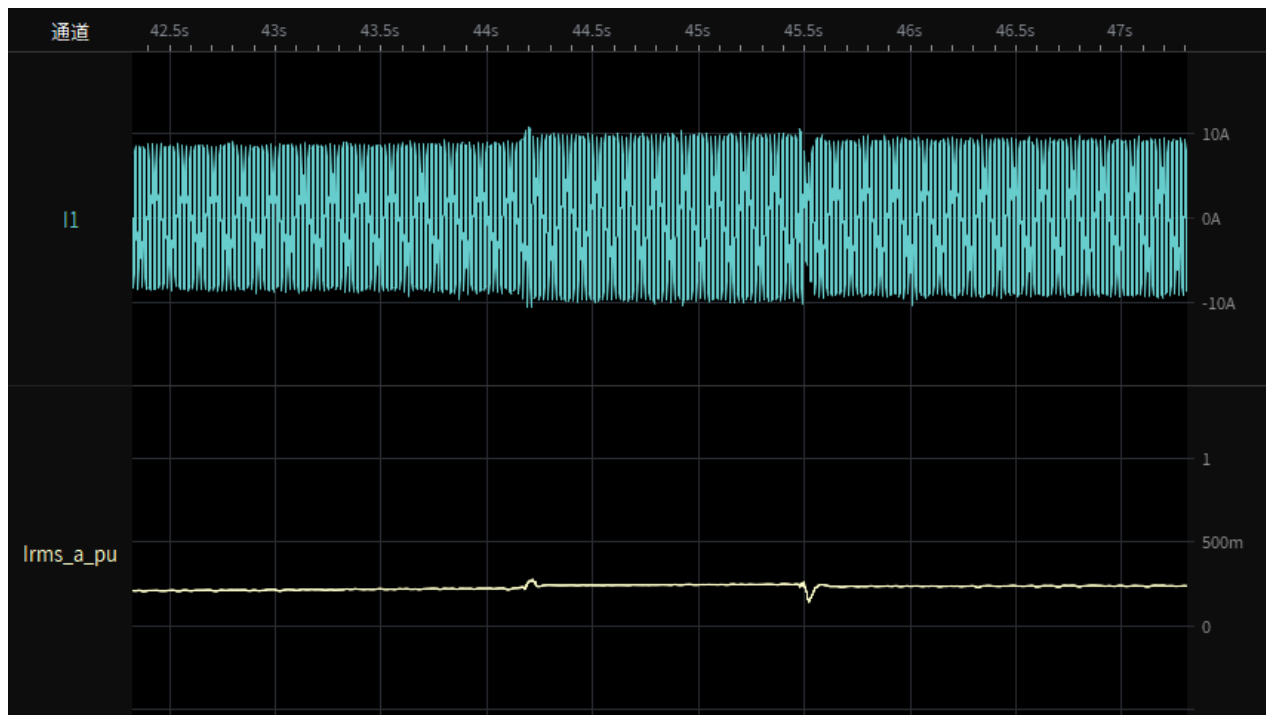

Test 4a-1.4 Depth of fault phase: 0.75p.u.,two-phase-asymmetrical (type D),20% load
restoring time

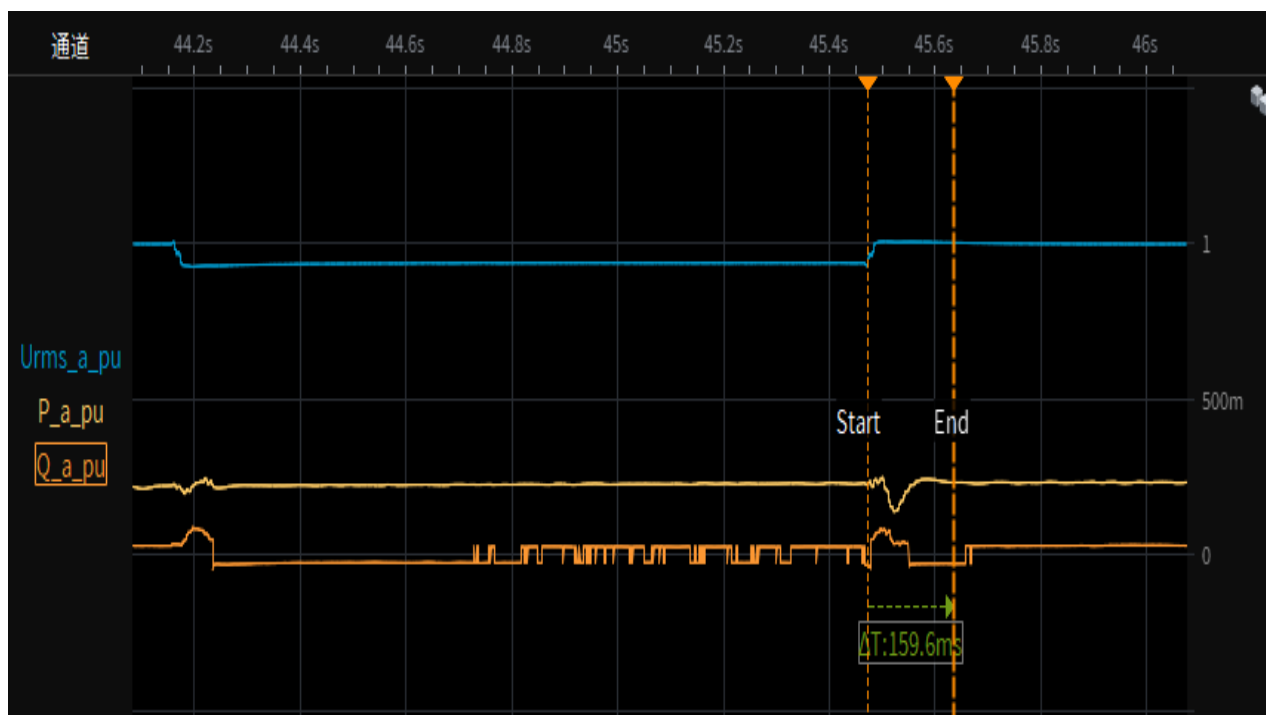

CEI 0-21			
Clause	Requirement - Test	Result - Remark	Verdict

Test 4a-2.1 Depth of fault phase: 0.75p.u.,two-phase-asymmetrical (type D),95% load
Test overview(voltage,current,active and reactive power)

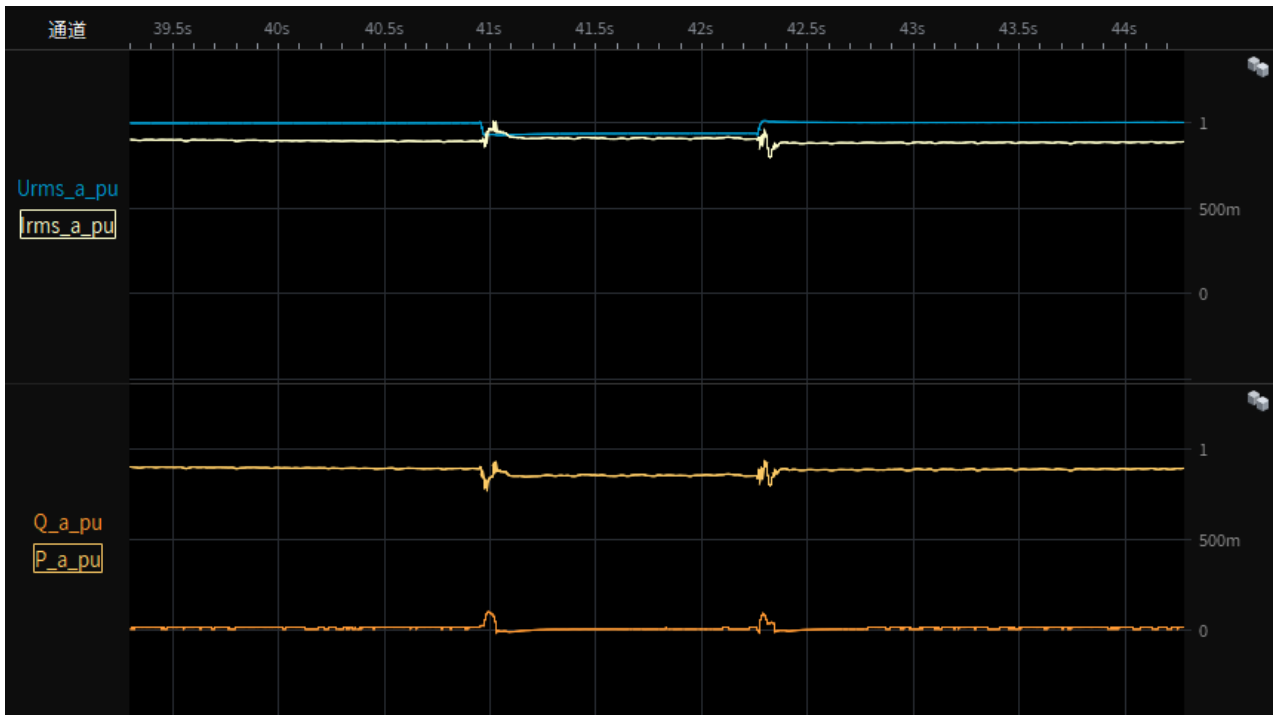

Test 4a-2.2 Depth of fault phase: 0.75p.u.,two-phase-asymmetrical (type D),95% load
Instantaneous curve and RMS value of phase-to-neutral voltages

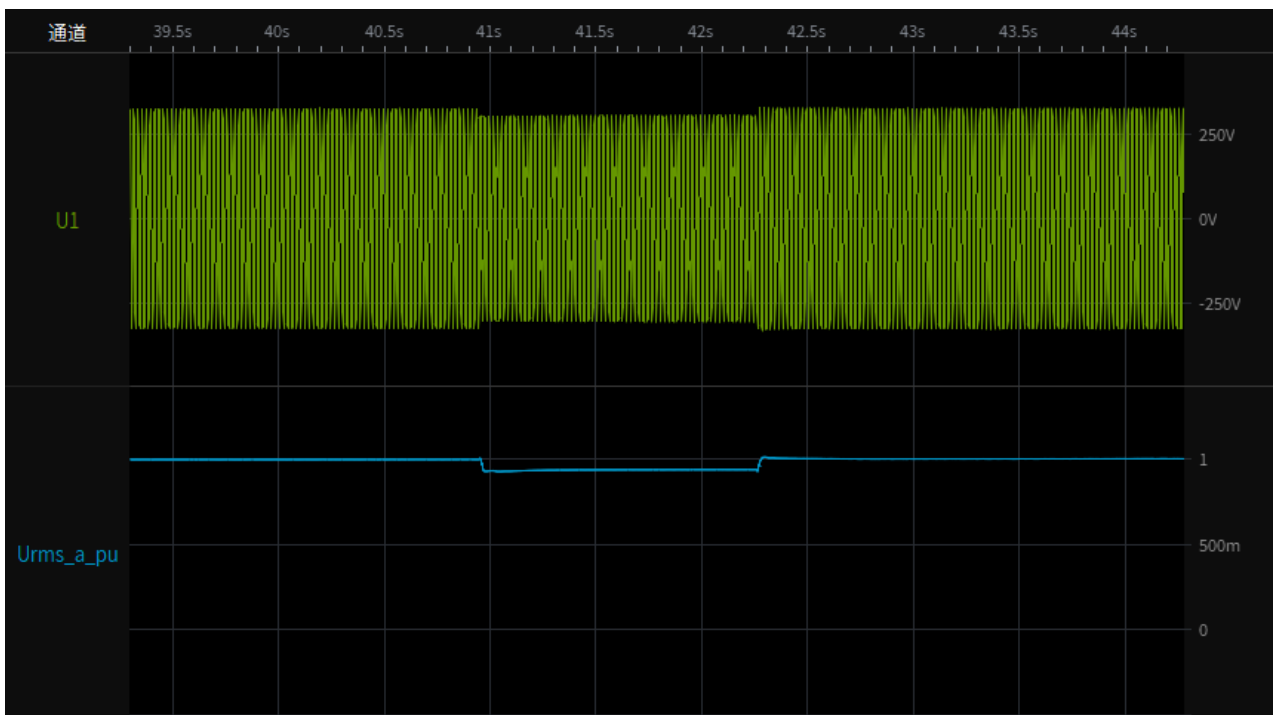

CEI 0-21			
Clause	Requirement - Test	Result - Remark	Verdict

Test 4a-2.3 Depth of fault phase: 0.75p.u.,two-phase-asymmetrical (type D),95% load
Instantaneous curve and RMS value of phase currents

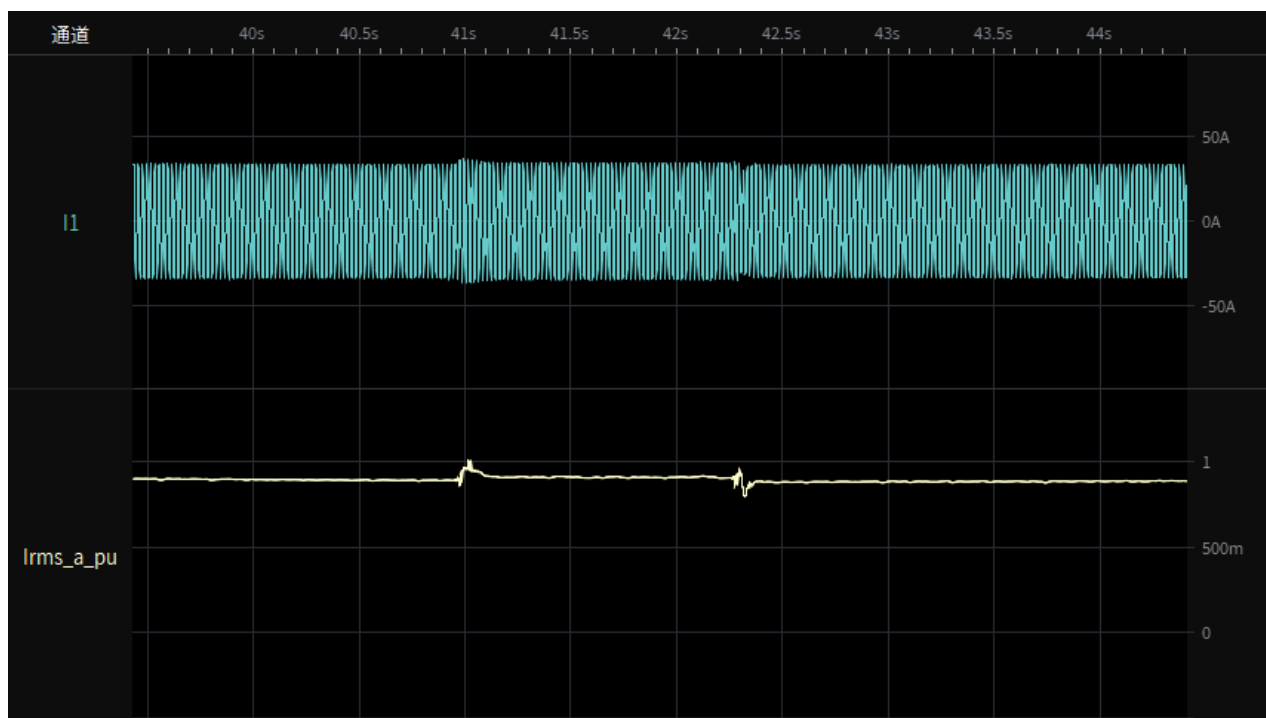

Test 4a-2.4 Depth of fault phase: 0.75p.u.,two-phase-asymmetrical (type D), 95% load
restoring time



CEI 0-21			
Clause	Requirement - Test	Result - Remark	Verdict

Test 5-Depth of fault phase: 0.1p.u.,LV two-phase-asymmetrical (type D), 0% load
 Test overview(voltage,current,active and reactive power)

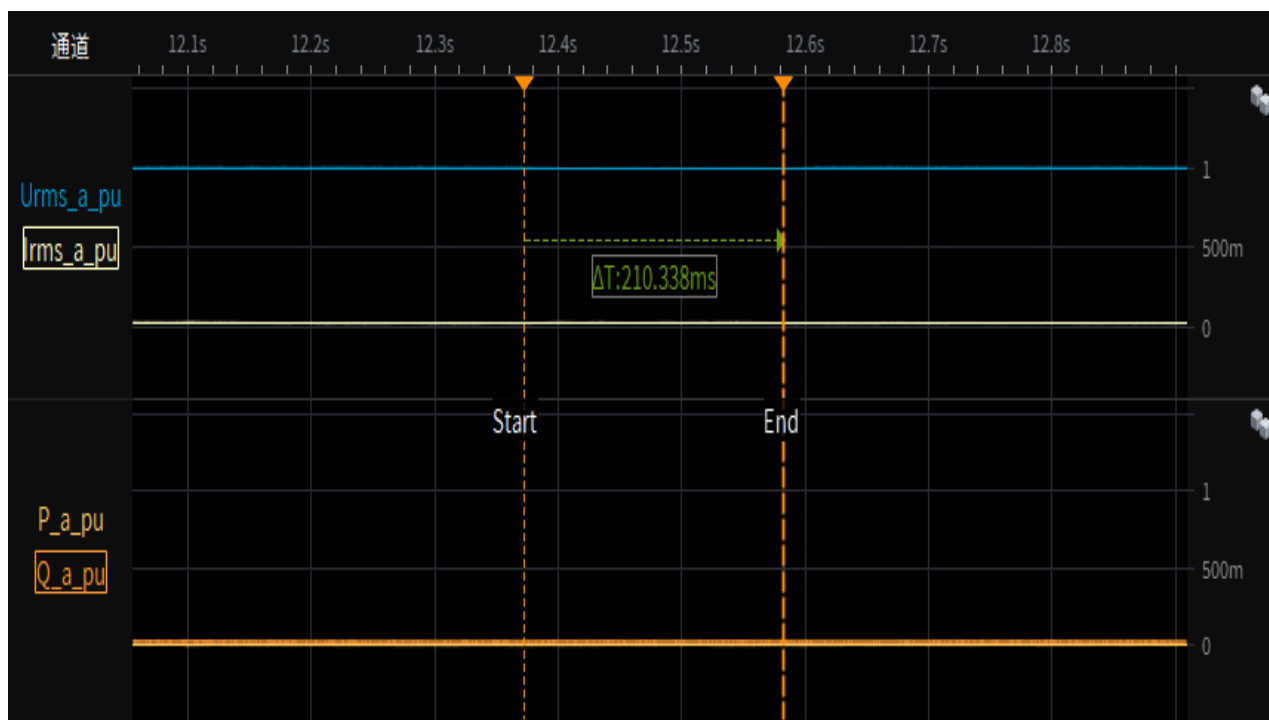

Test 5-1.1 Depth of fault phase: 0.1p.u.,LV two-phase-asymmetrical (type D),20% load
 Test overview(voltage,current,active and reactive power)

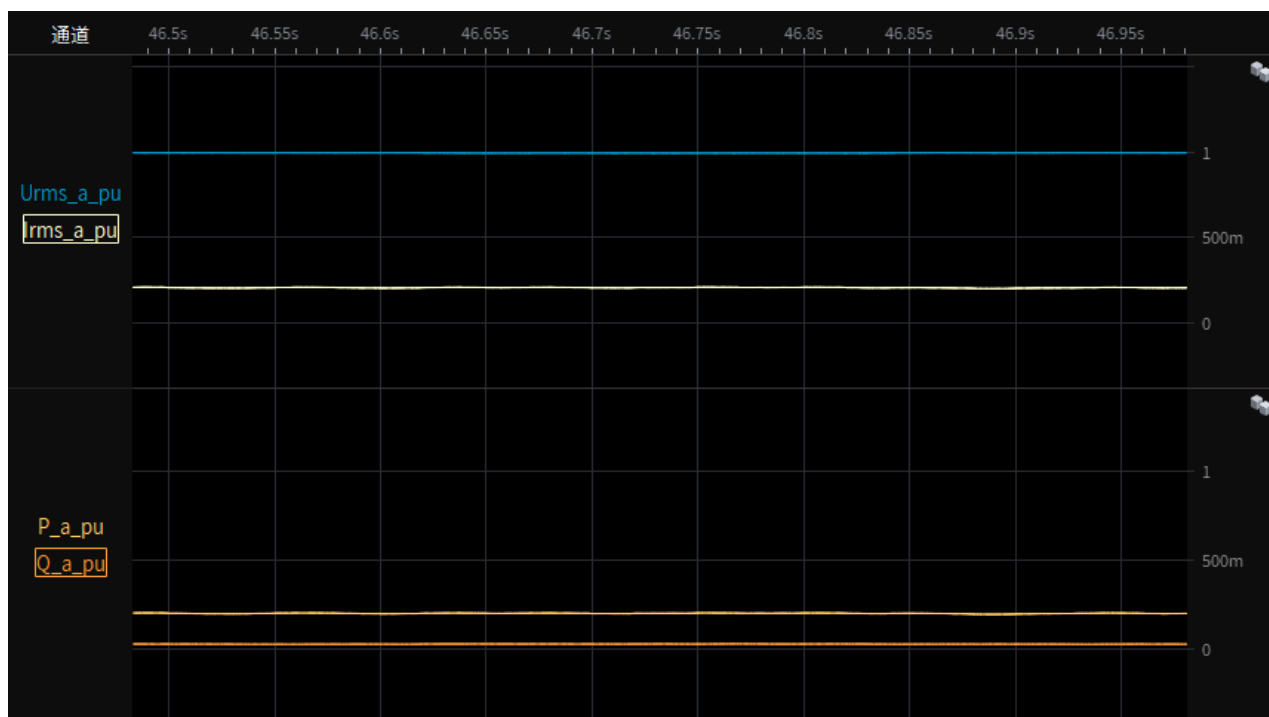

CEI 0-21			
Clause	Requirement - Test	Result - Remark	Verdict

Test 5-1.2 Depth of fault phase: 0.1p.u.,LV two-phase-asymmetrical (type D),20% load
Instantaneous curve and RMS value of phase-to-neutral voltages

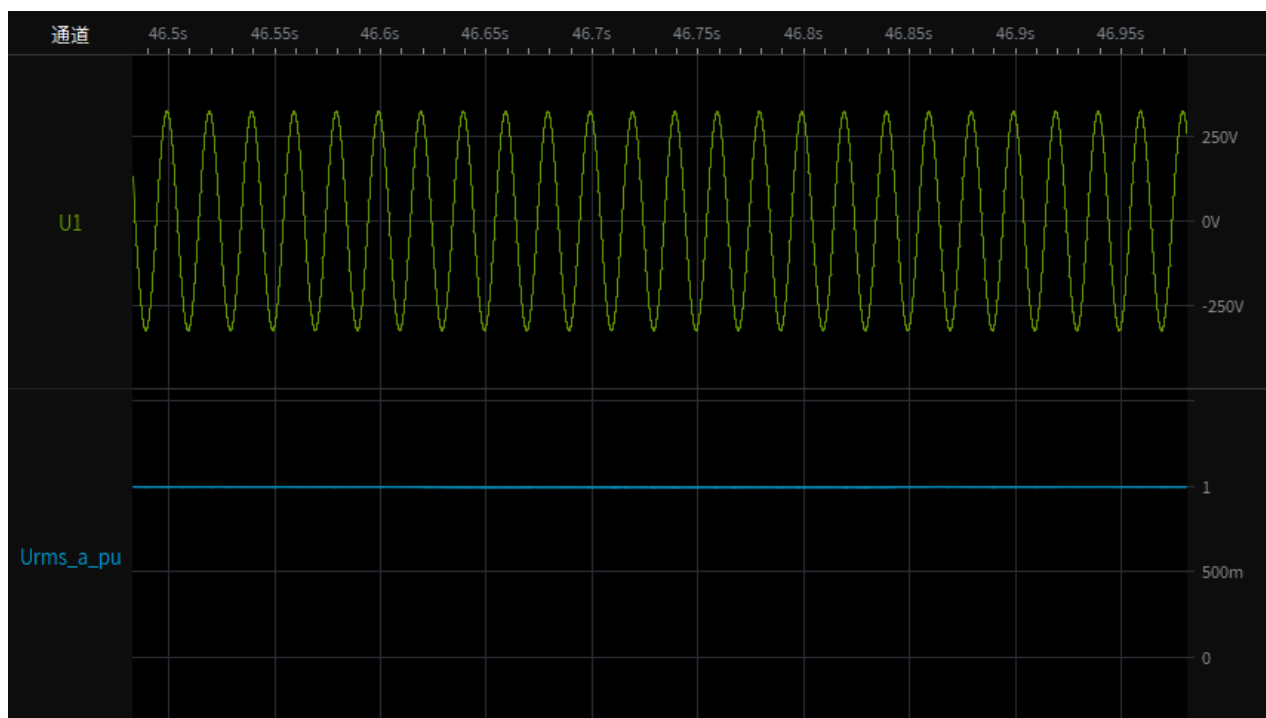

Test 5-1.3 Depth of fault phase: 0.1p.u.,LV two-phase-asymmetrical (type D),20% load
Instantaneous curve and RMS value of phase currents

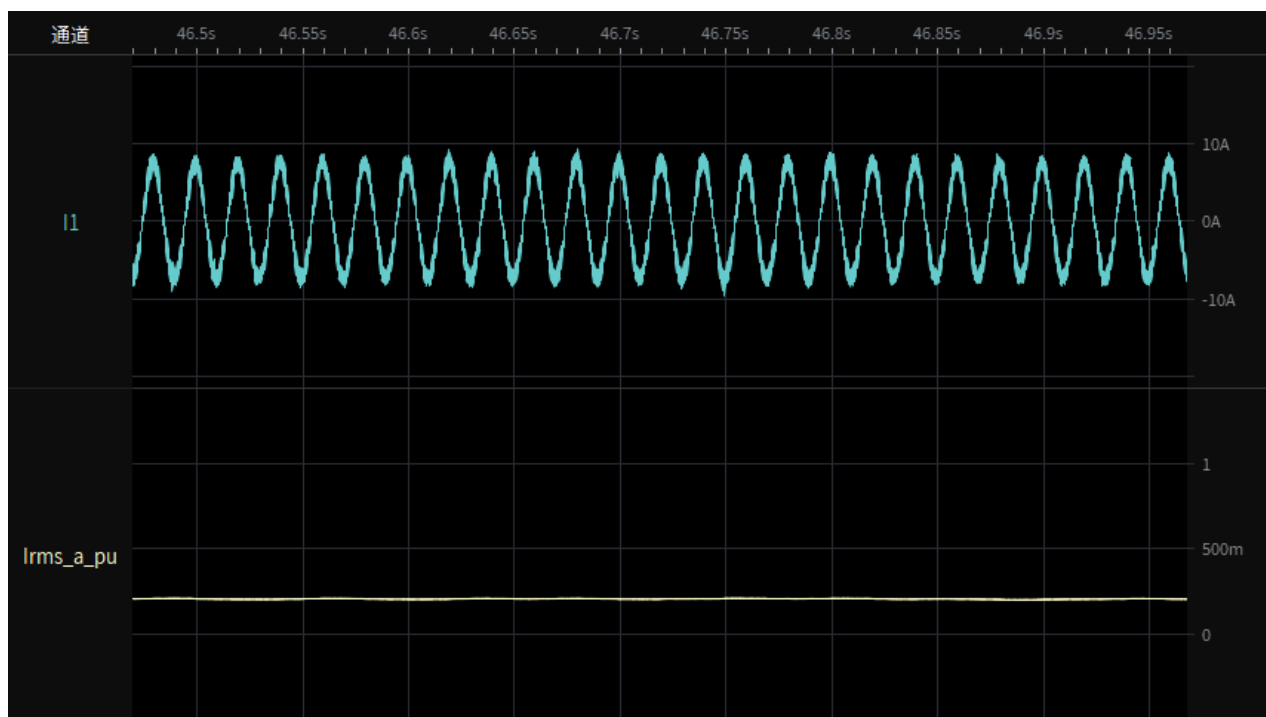

CEI 0-21			
Clause	Requirement - Test	Result - Remark	Verdict

Test 5-1.4 Depth of fault phase: 0.1p.u.,LV two-phase-asymmetrical (type D),20% load restoring time

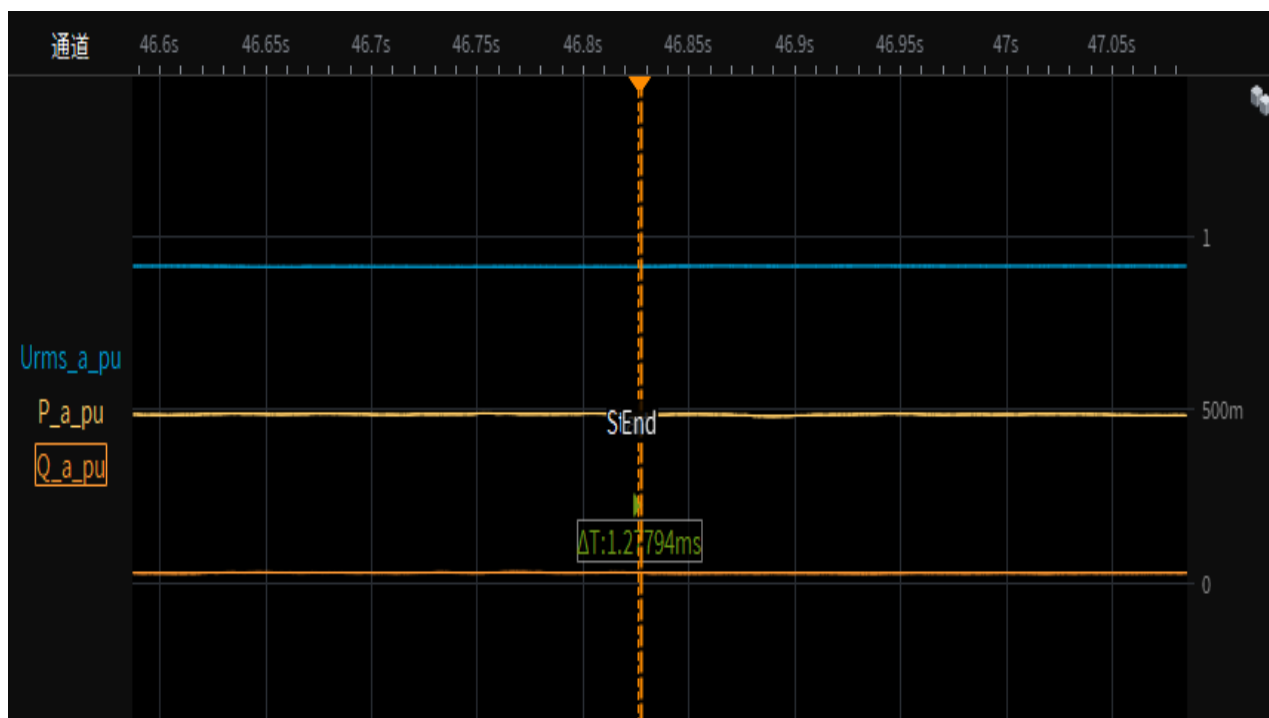

Test 5-2.1 Depth of fault phase: 0.1p.u.,LV two-phase-asymmetrical (type D),95% load Test overview(voltage,current,active and reactive power)

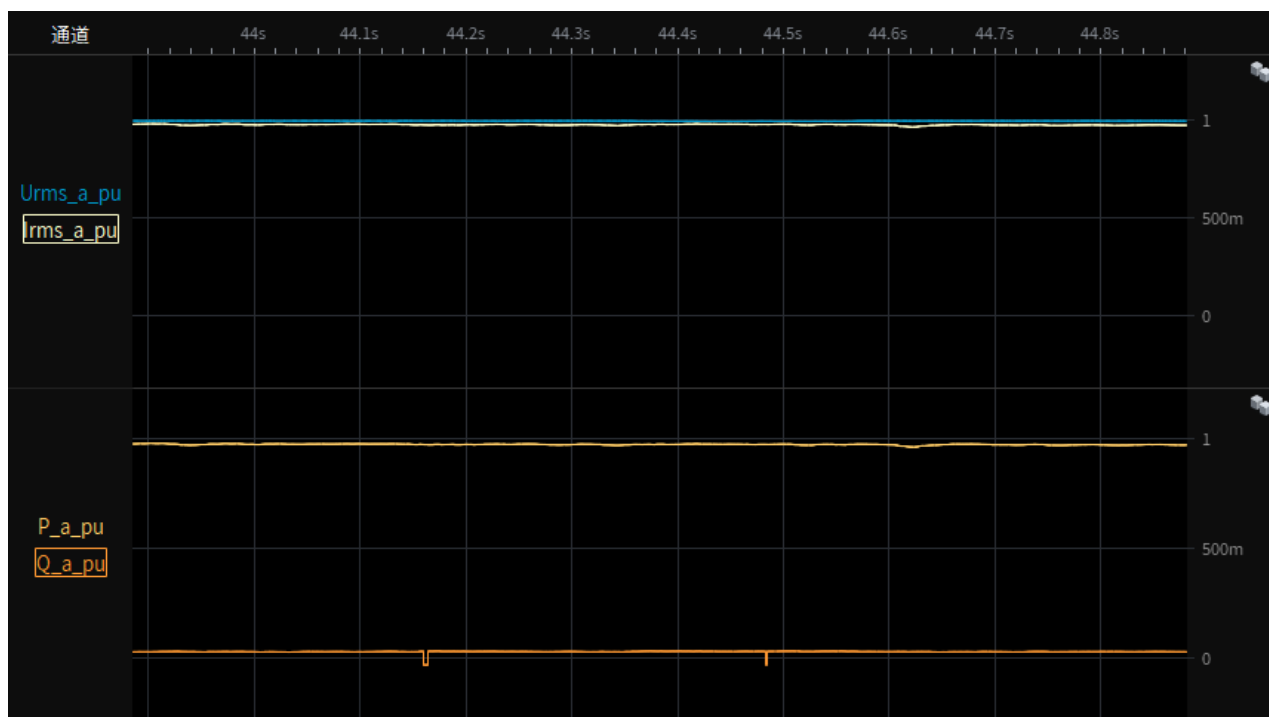

CEI 0-21			
Clause	Requirement - Test	Result - Remark	Verdict

Test 5-2.2 Depth of fault phase: 0.1p.u.,LV two-phase-asymmetrical (type D),95% load
Instantaneous curve and RMS value of phase-to-neutral voltages

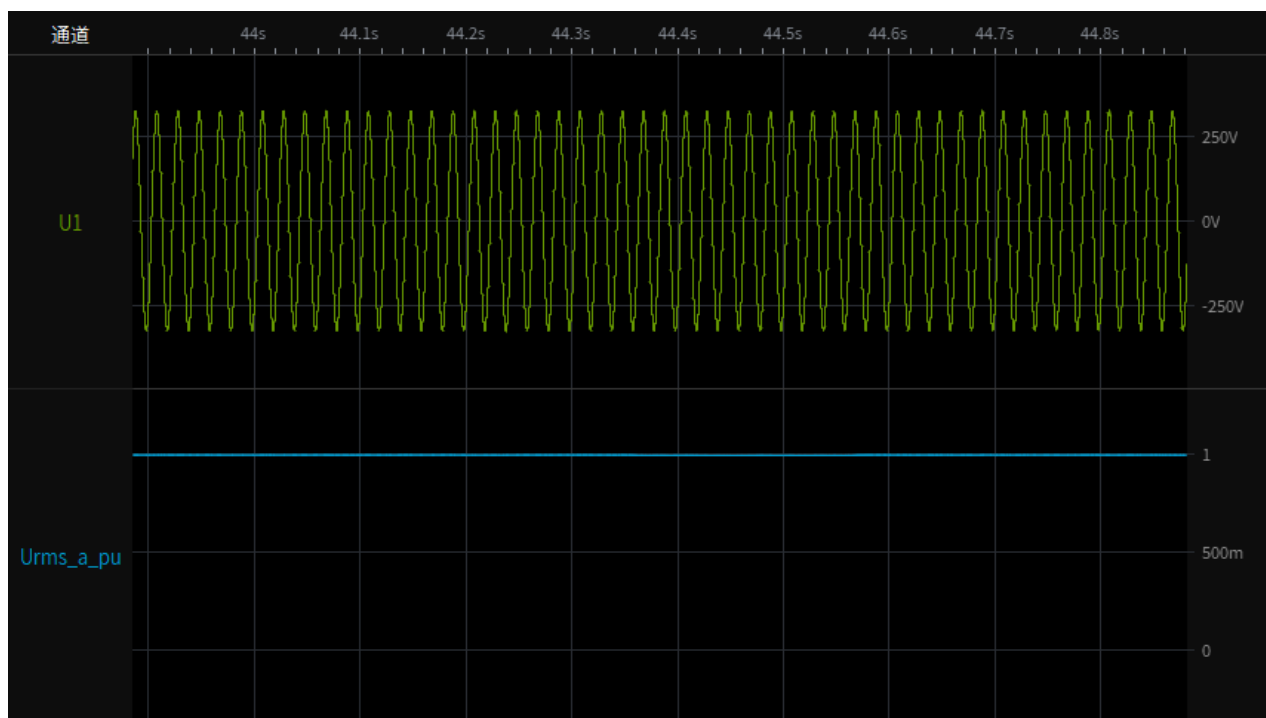

Test 5-2.3 Depth of fault phase: 0.1p.u.,LV two-phase-asymmetrical (type D),95% load
Instantaneous curve and RMS value of phase currents

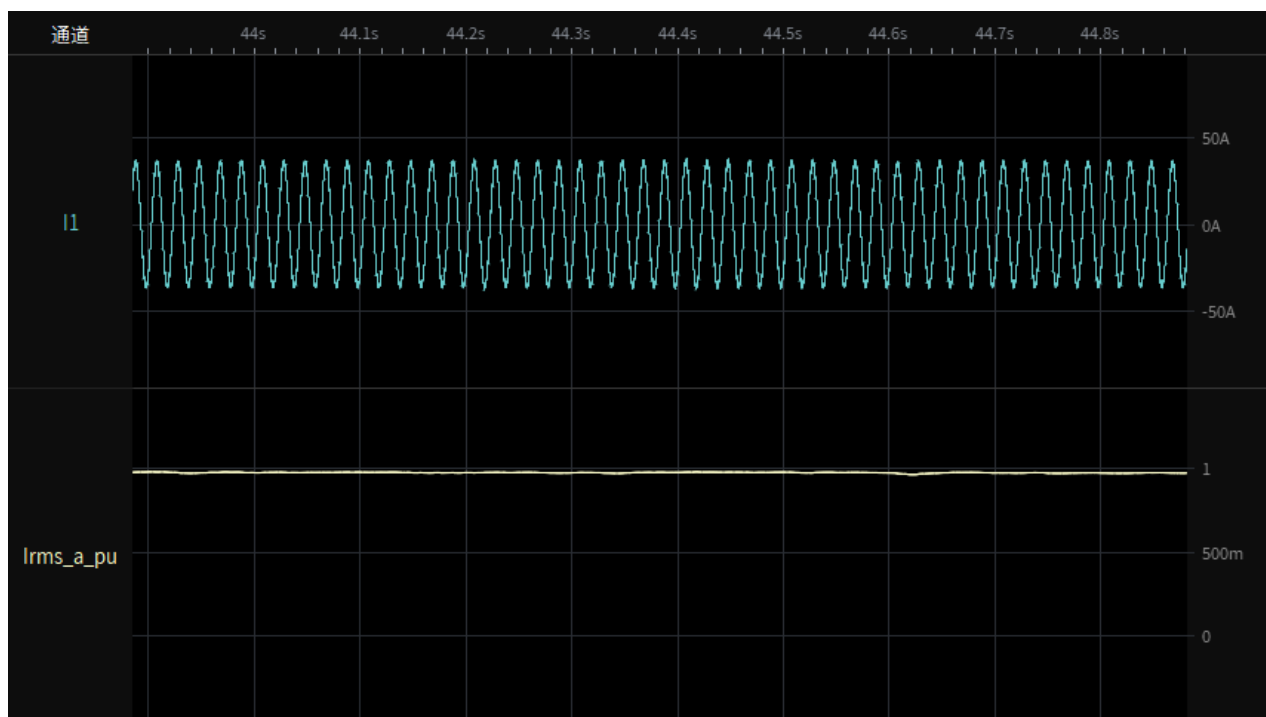

CEI 0-21			
Clause	Requirement - Test	Result - Remark	Verdict

Test 5-2.4 Depth of fault phase: 0.1p.u.,LV two-phase-asymmetrical (type D), 95% load restoring time

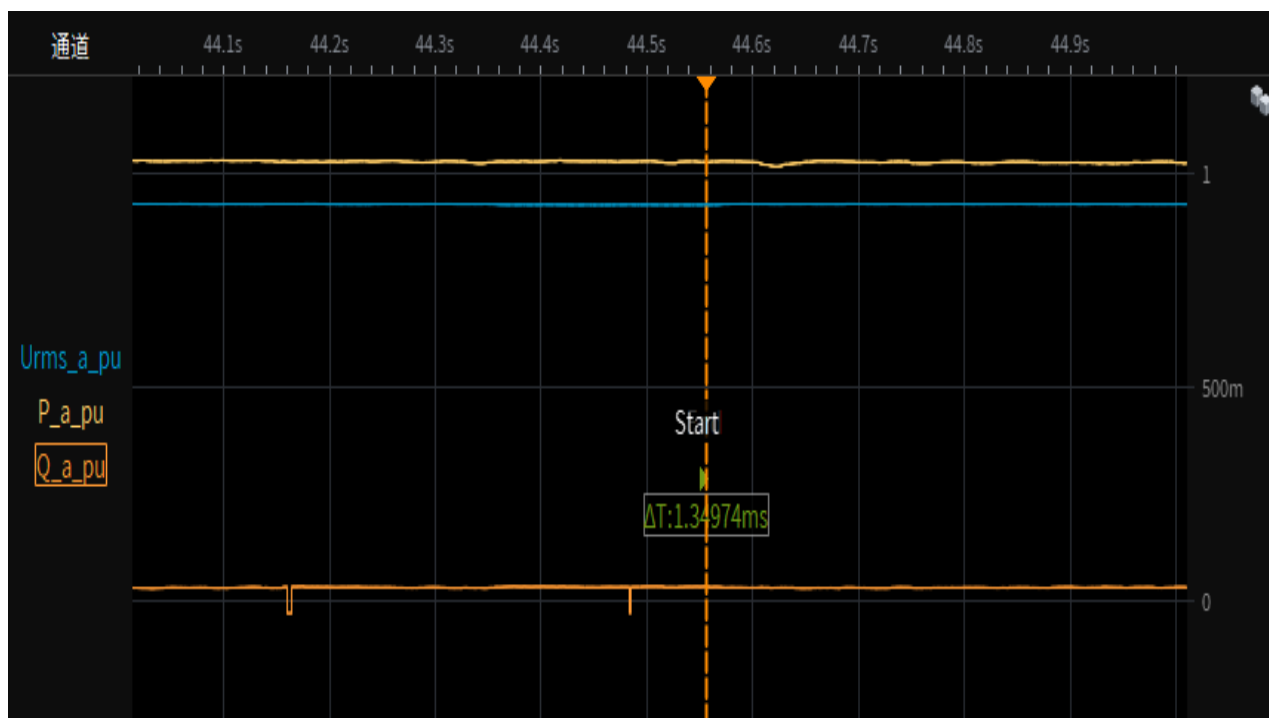

Test 6-Depth of fault phase: 0.5p.u.,LV two-phase-asymmetrical (type D), 0% load Test overview(voltage,current,active and reactive power)

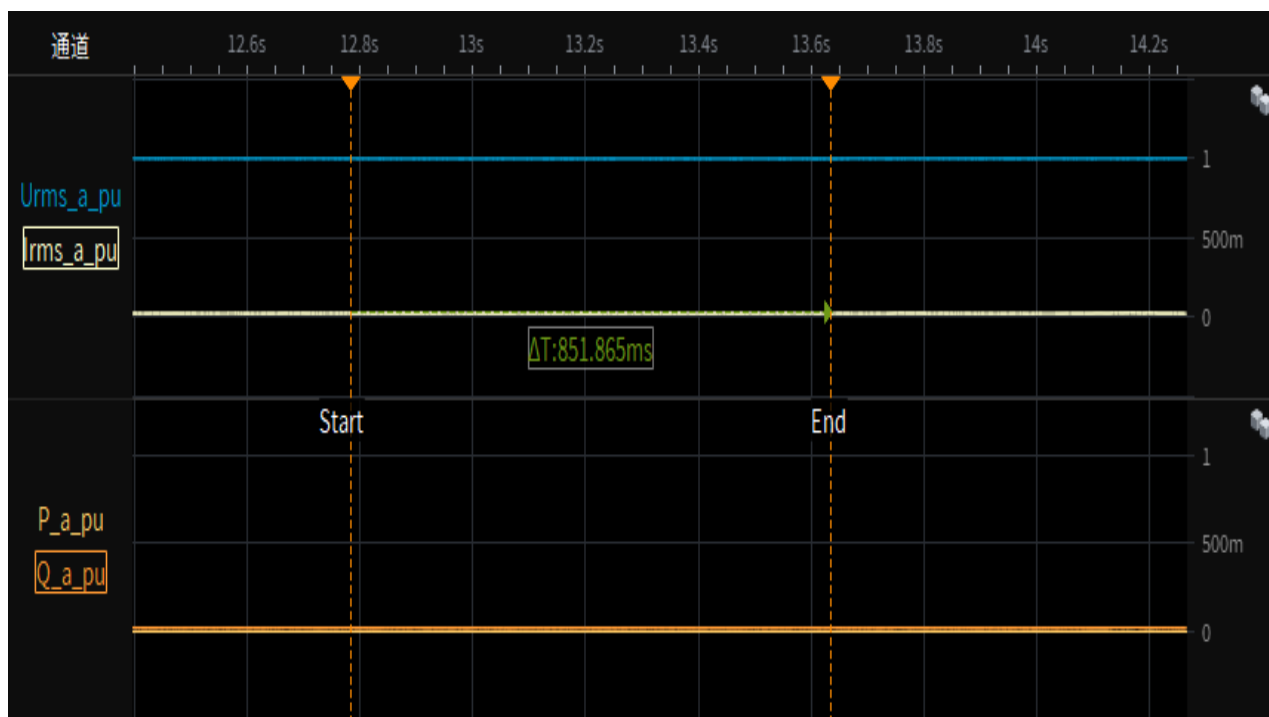

CEI 0-21			
Clause	Requirement - Test	Result - Remark	Verdict

Test 6-1.1 Depth of fault phase: 0.5p.u.,LV two-phase-asymmetrical (type D),20% load
Test overview(voltage,current,active and reactive power)

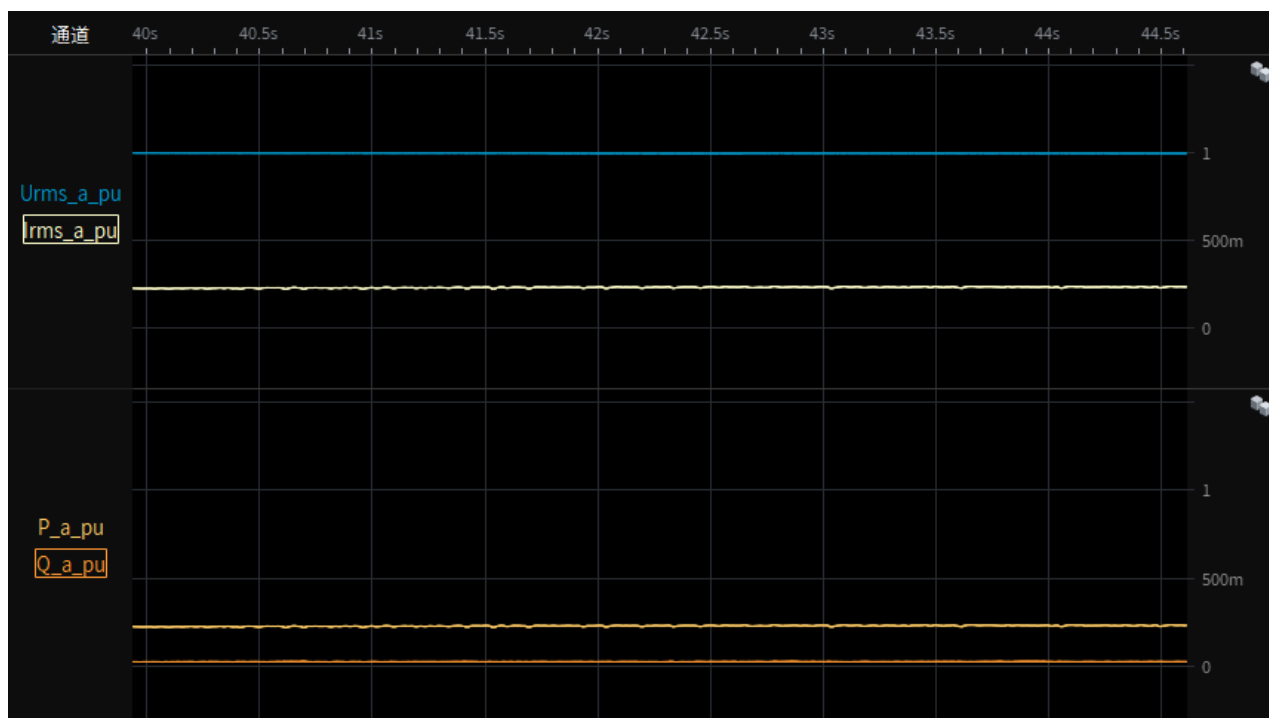

Test 6-1.2 Depth of fault phase: 0.5p.u.,LV two-phase-asymmetrical (type D),20% load
Instantaneous curve and RMS value of phase-to-neutral voltages

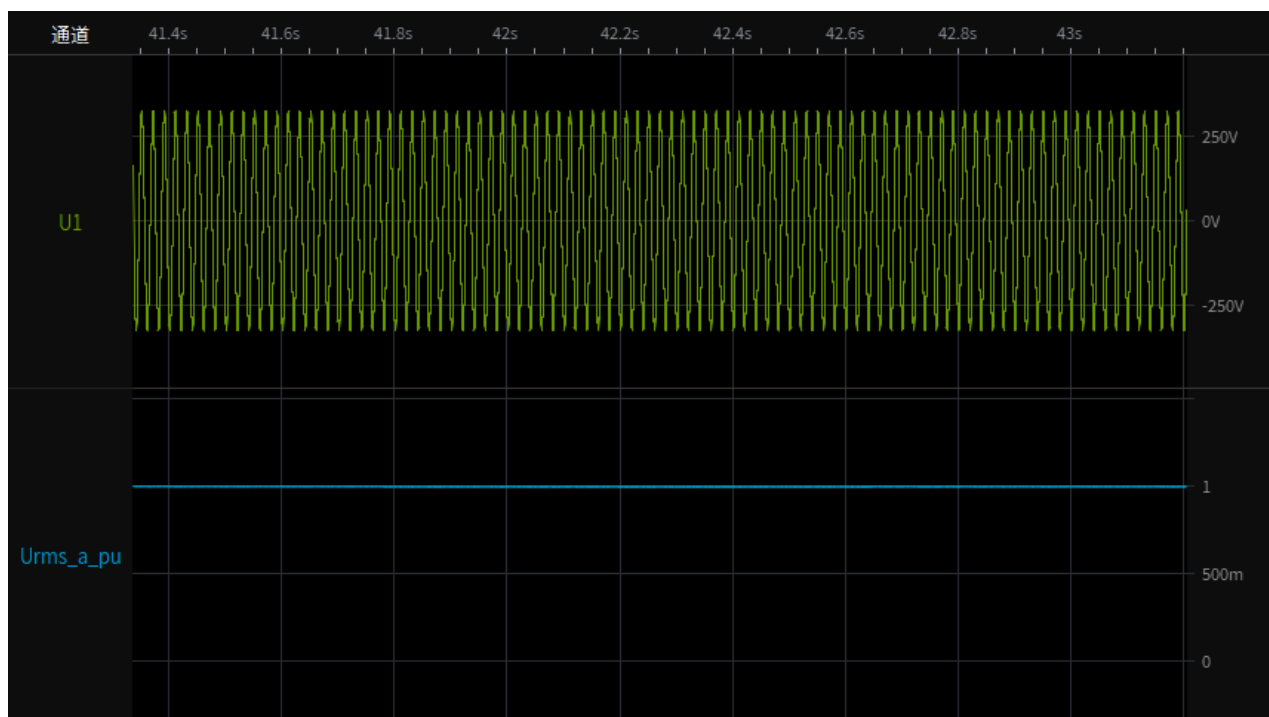

CEI 0-21			
Clause	Requirement - Test	Result - Remark	Verdict

Test 6-1.3 Depth of fault phase: 0.5p.u., LV two-phase-asymmetrical (type D), 20% load
Instantaneous curve and RMS value of phase currents

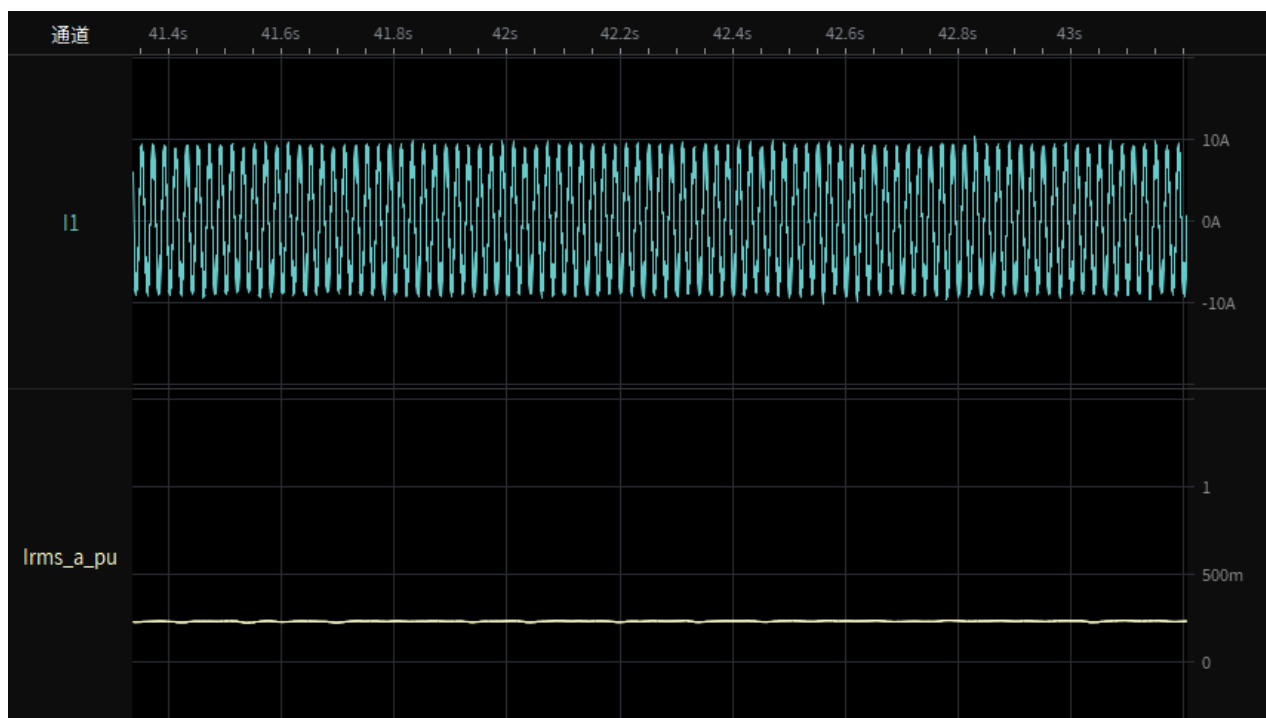

Test 6-1.4 Depth of fault phase: 0.5p.u., LV two-phase-asymmetrical (type D), 20% load
restoring time

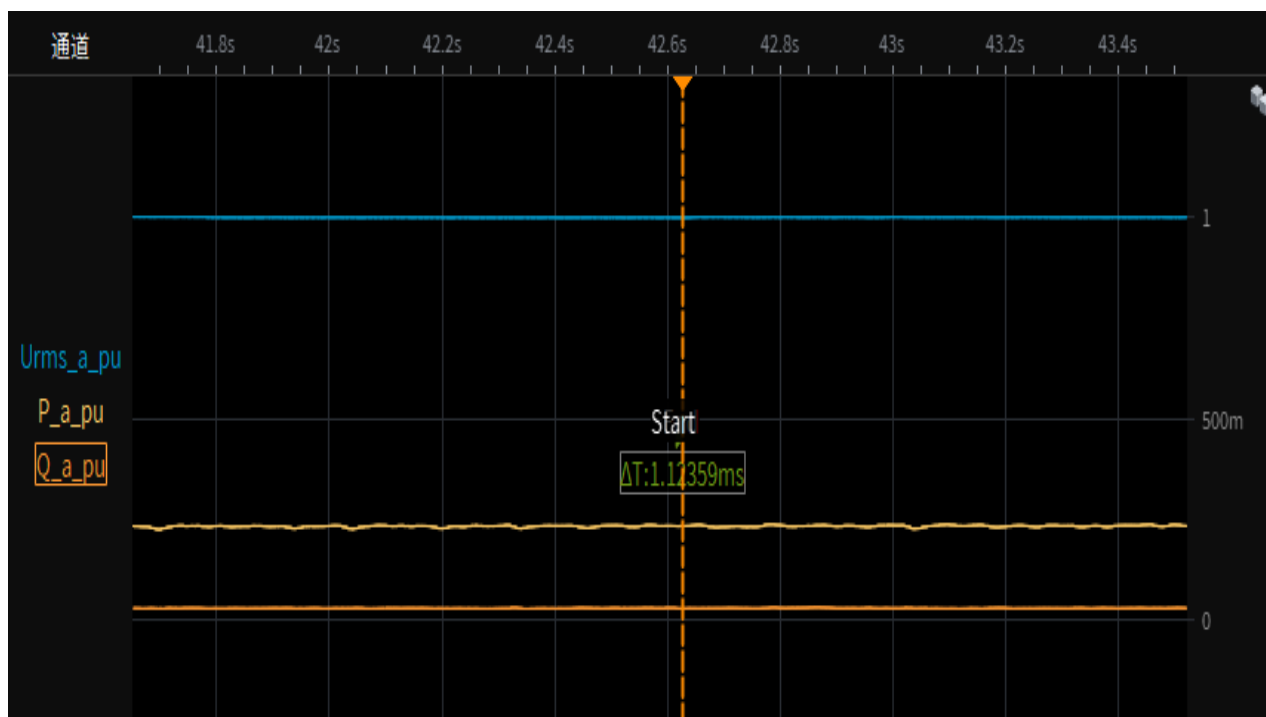

CEI 0-21			
Clause	Requirement - Test	Result - Remark	Verdict

Test 6-2.1 Depth of fault phase: 0.5p.u., LV two-phase-asymmetrical (type D), 95% load
 Test overview(voltage,current,active and reactive power)

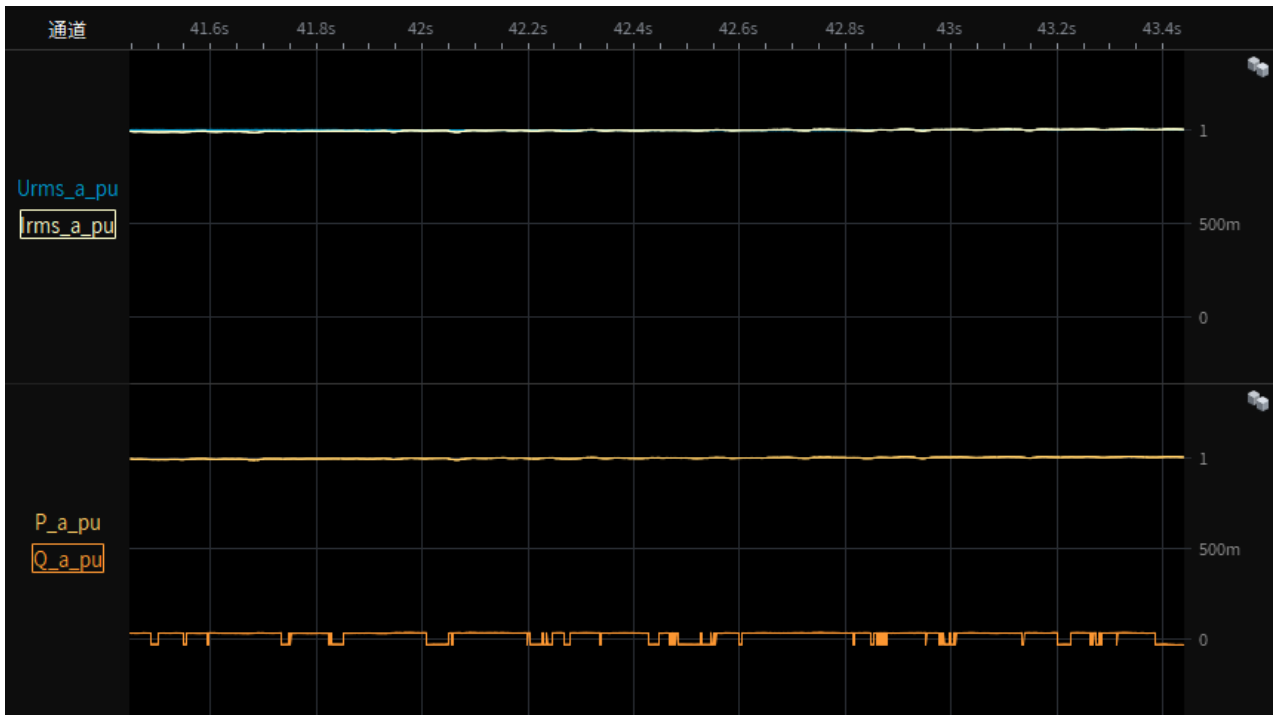

Test 6-2.2 Depth of fault phase: 0.5p.u., LV two-phase-asymmetrical (type D), 95% load
 Instantaneous curve and RMS value of phase-to-neutral voltages

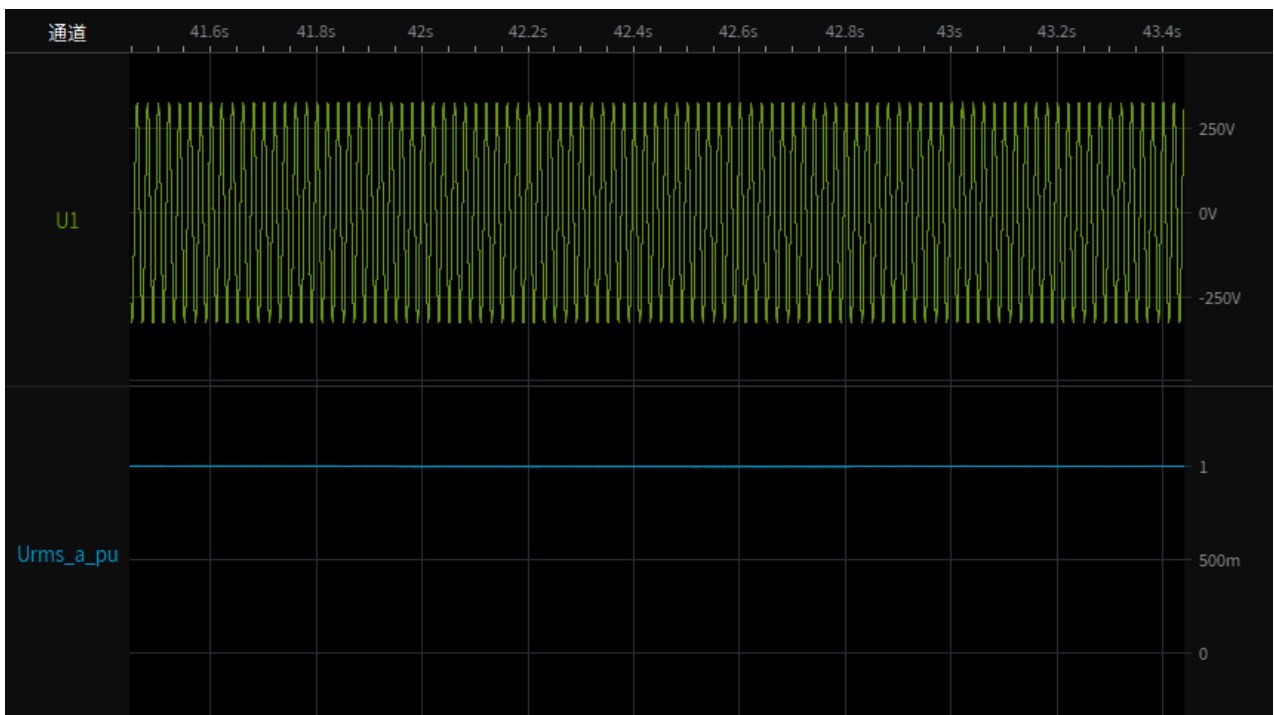

CEI 0-21			
Clause	Requirement - Test	Result - Remark	Verdict

Test 6-2.3 Depth of fault phase: 0.5p.u., LV two-phase-asymmetrical (type D), 95% load
Instantaneous curve and RMS value of phase currents

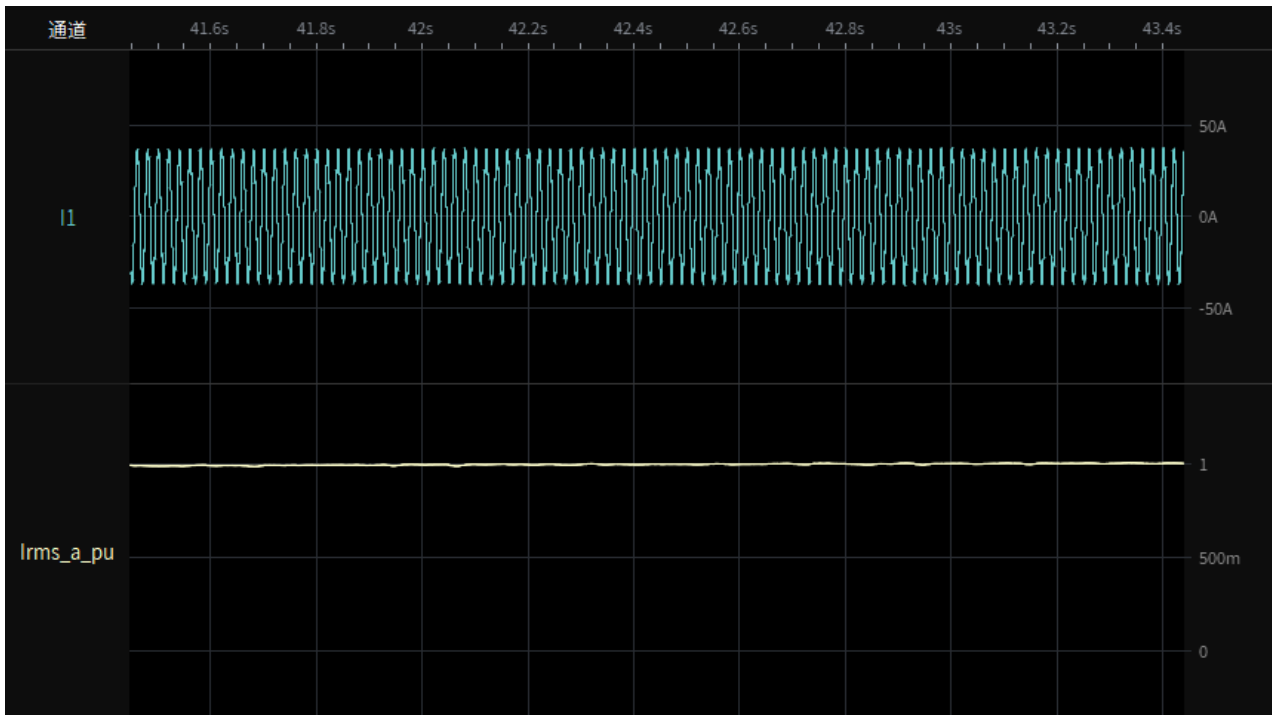

Test 6-2.4 Depth of fault phase: 0.5p.u., LV two-phase-asymmetrical (type D), 95% load
restoring time

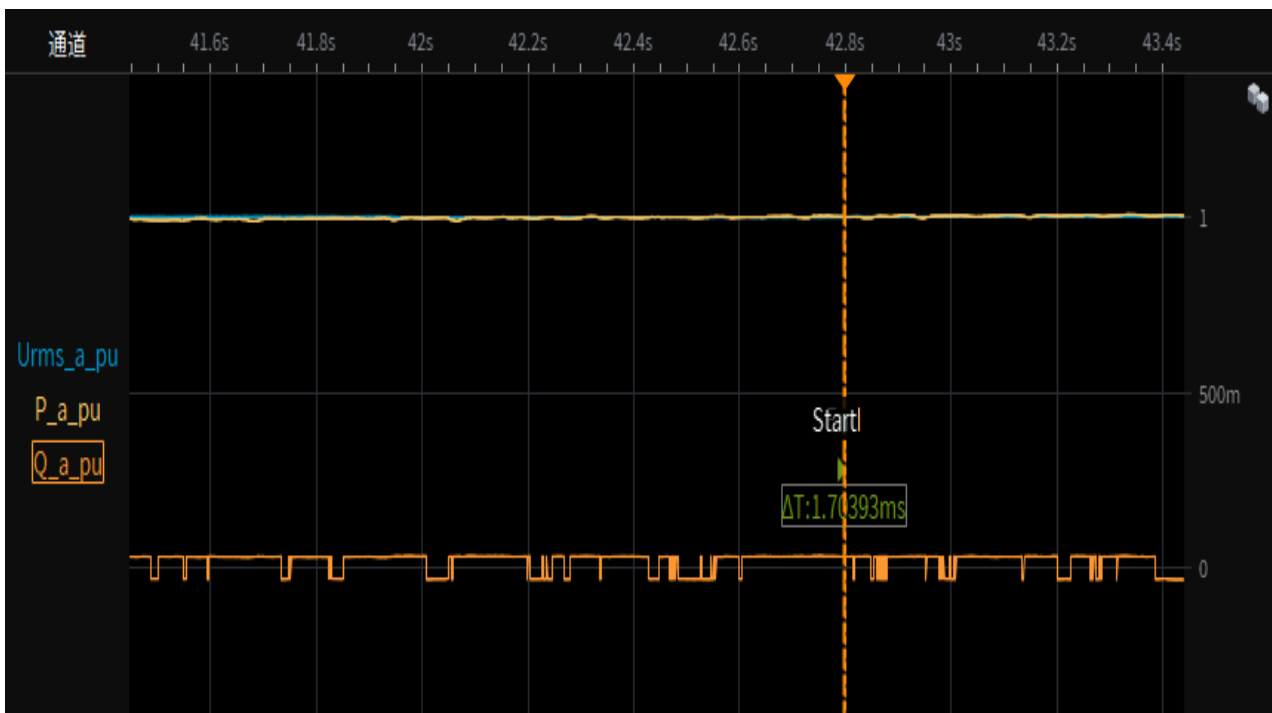

CEI 0-21			
Clause	Requirement - Test	Result - Remark	Verdict

Test 7-Depth of fault phase: 1.20p.u.,three-phase-symmetrical (type A), 0% load
Test overview(voltage,current,active and reactive power)

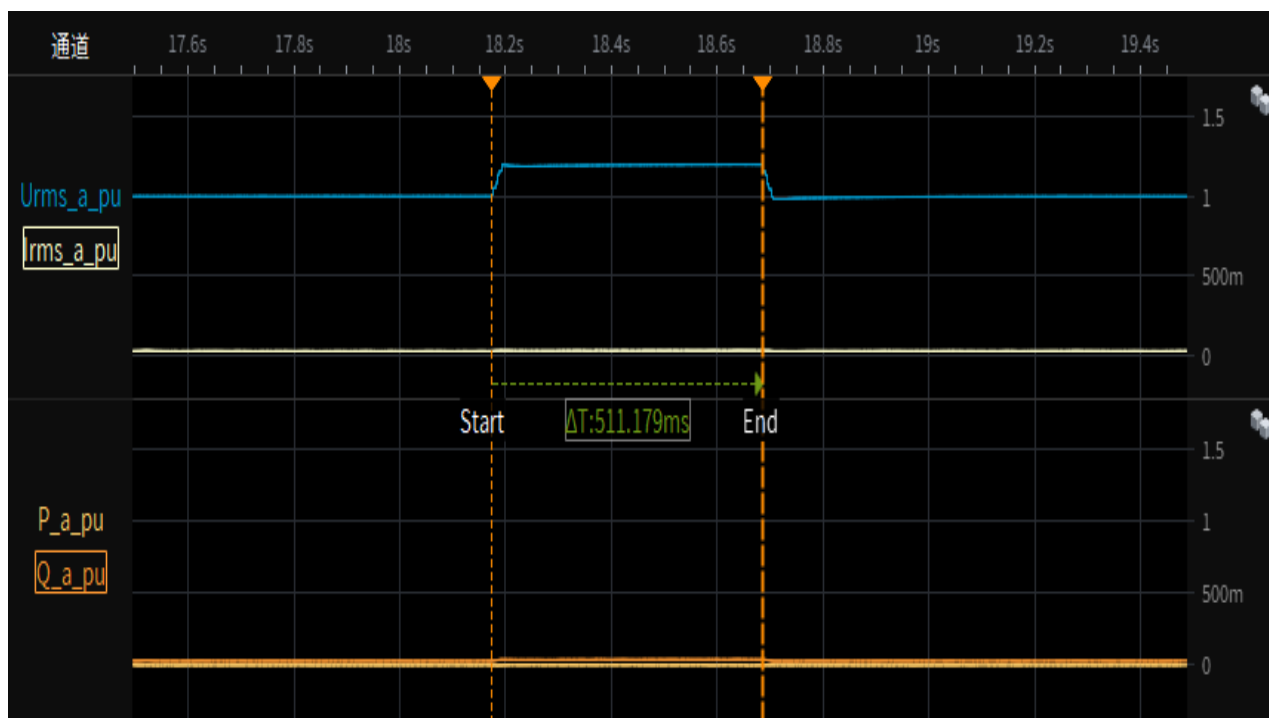

Test 7-1.1 Depth of fault phase: 1.20p.u.,three-phase-symmetrical (type A),20% load
Test overview(voltage,current,active and reactive power)

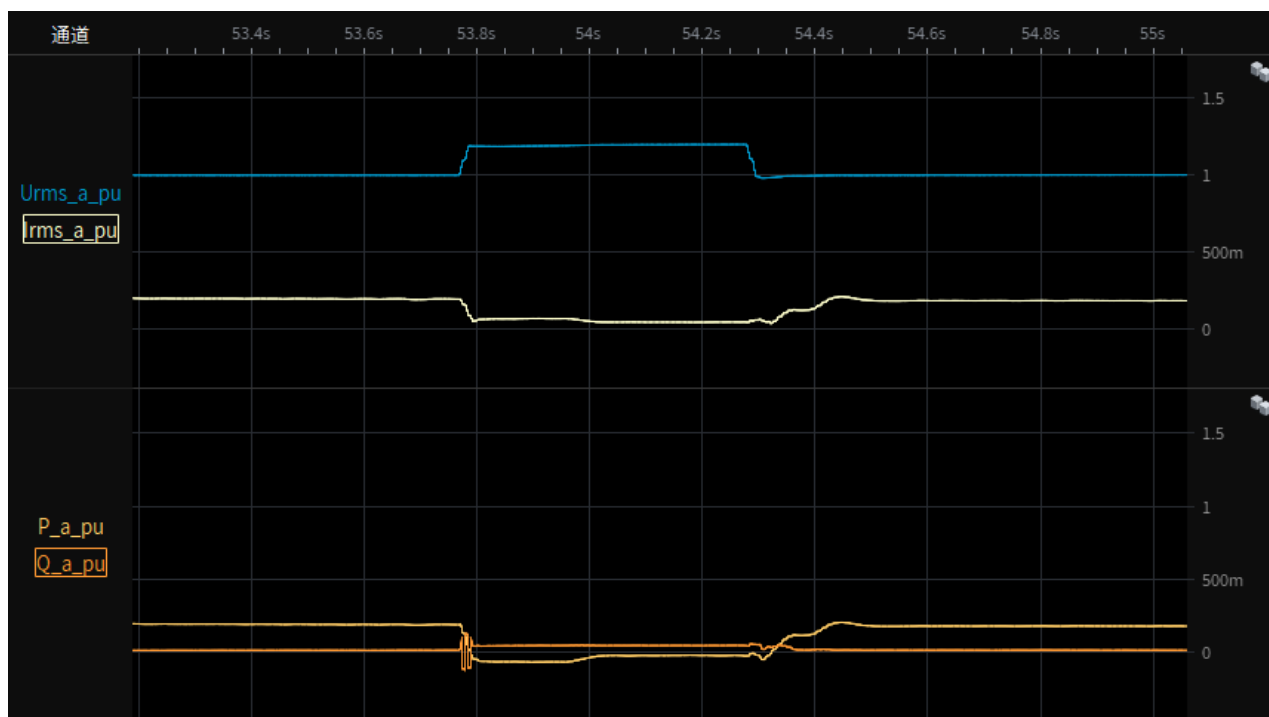

CEI 0-21			
Clause	Requirement - Test	Result - Remark	Verdict

Test 7-1.2 Depth of fault phase: 1.20p.u.,three-phase-symmetrical (type A),20% load
Instantaneous curve and RMS value of phase-to-neutral voltages

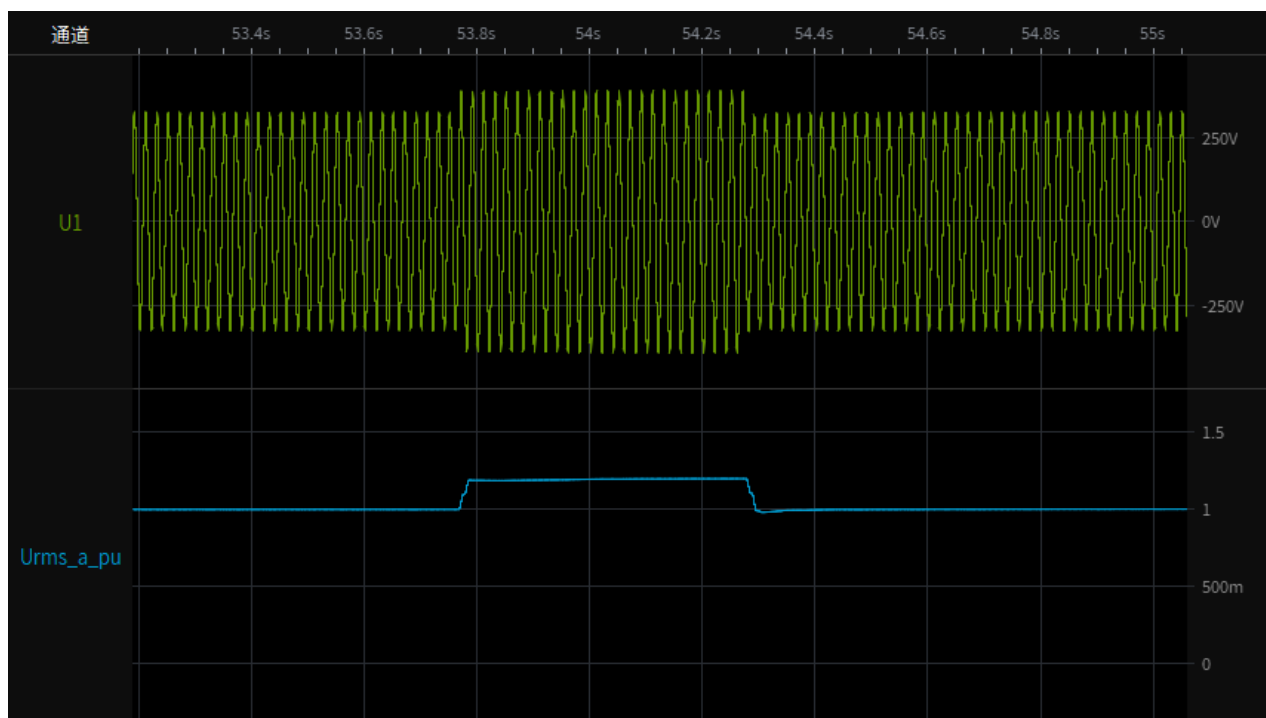

Test 7-1.3 Depth of fault phase: 1.20p.u.,three-phase-symmetrical (type A),20% load
Instantaneous curve and RMS value of phase currents

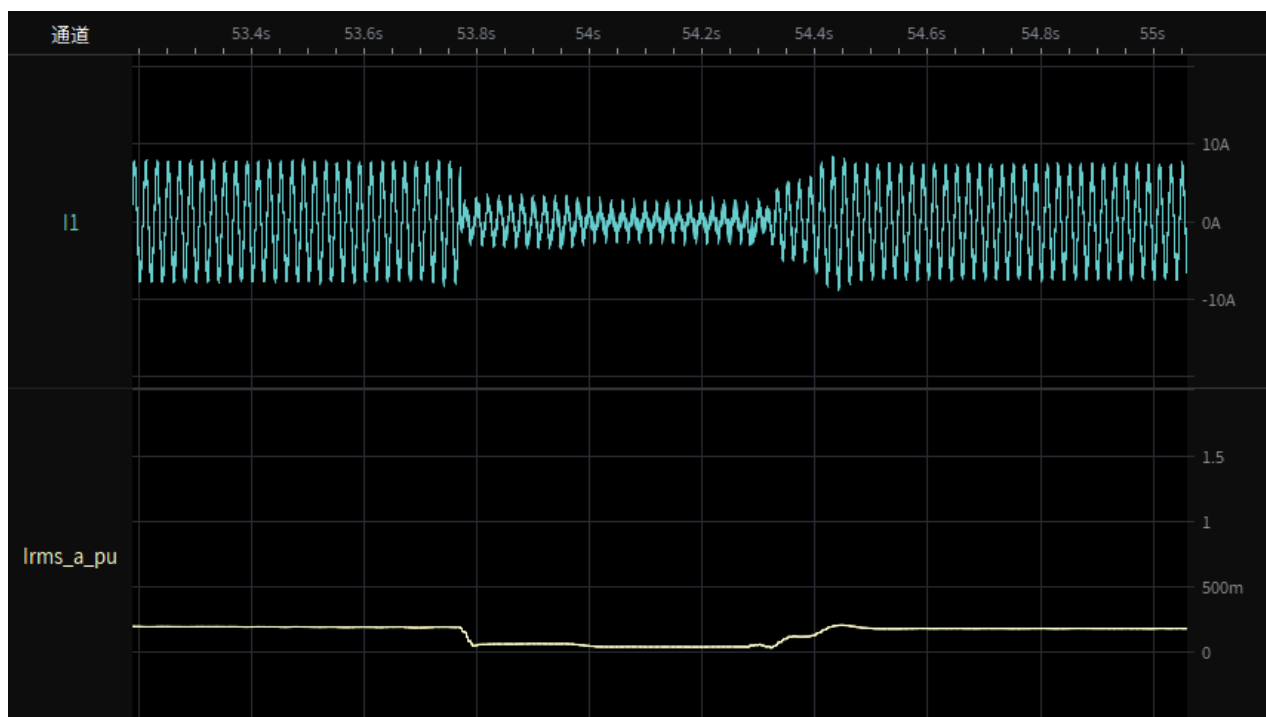

CEI 0-21			
Clause	Requirement - Test	Result - Remark	Verdict

Test 7-1.4 Depth of fault phase: 1.20p.u.,three-phase-symmetrical (type A),20% load restoring time

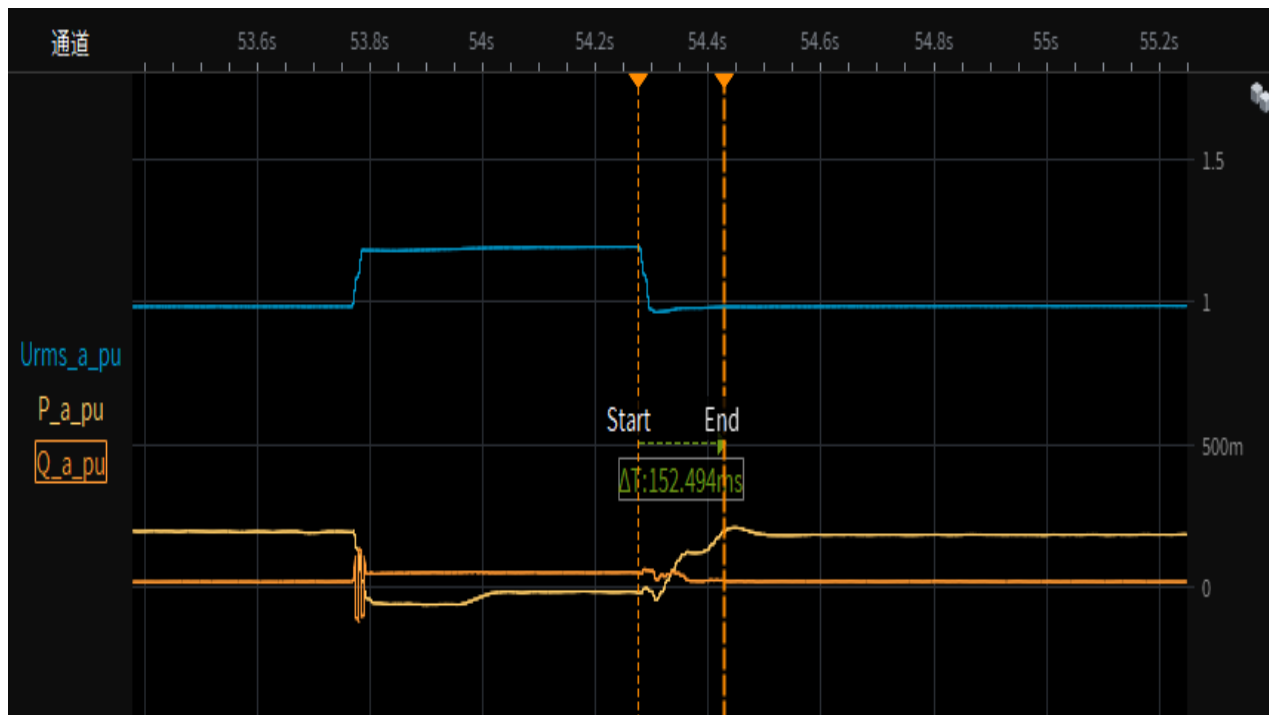

Test 7-2.1 Depth of fault phase: 1.20p.u.,three-phase-symmetrical (type A),95% load Test overview(voltage,current,active and reactive power)

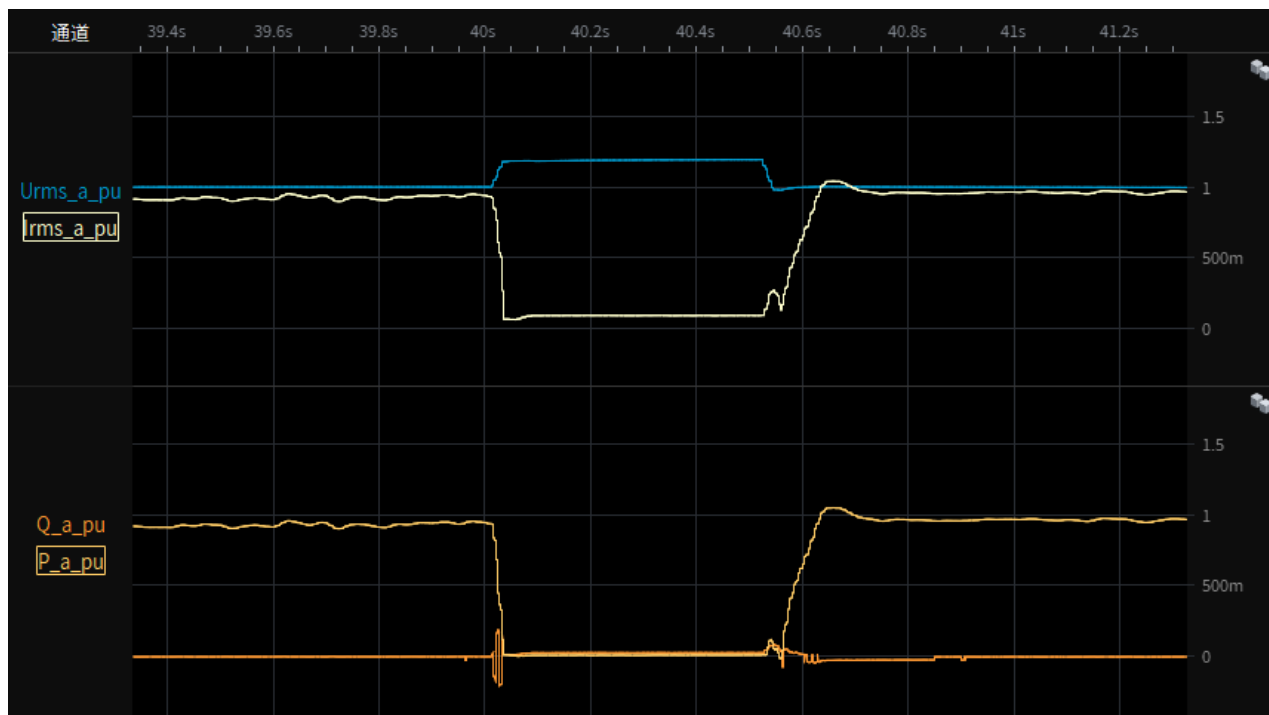

CEI 0-21			
Clause	Requirement - Test	Result - Remark	Verdict

Test 7-2.2 Depth of fault phase: 1.20p.u.,three-phase-symmetrical (type A),95% load
Instantaneous curve and RMS value of phase-to-neutral voltages

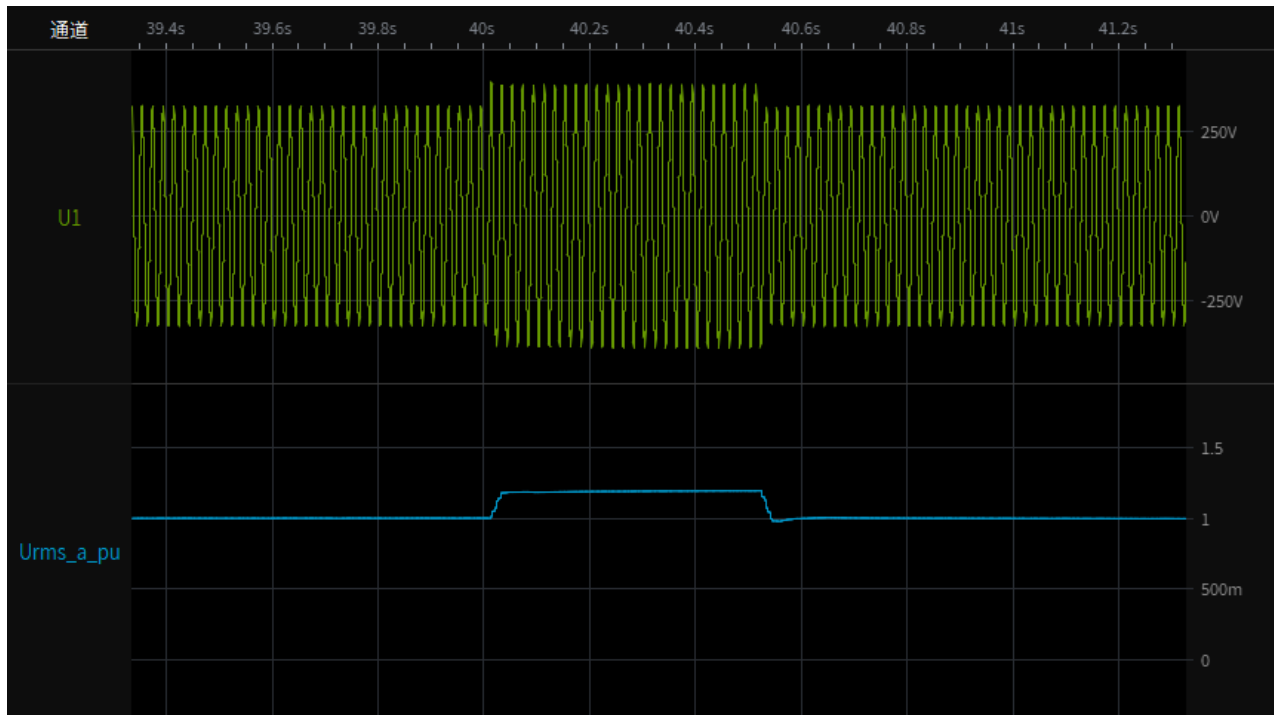

Test 7-2.3 Depth of fault phase: 1.20p.u.,three-phase-symmetrical (type A),95% load
Instantaneous curve and RMS value of phase currents

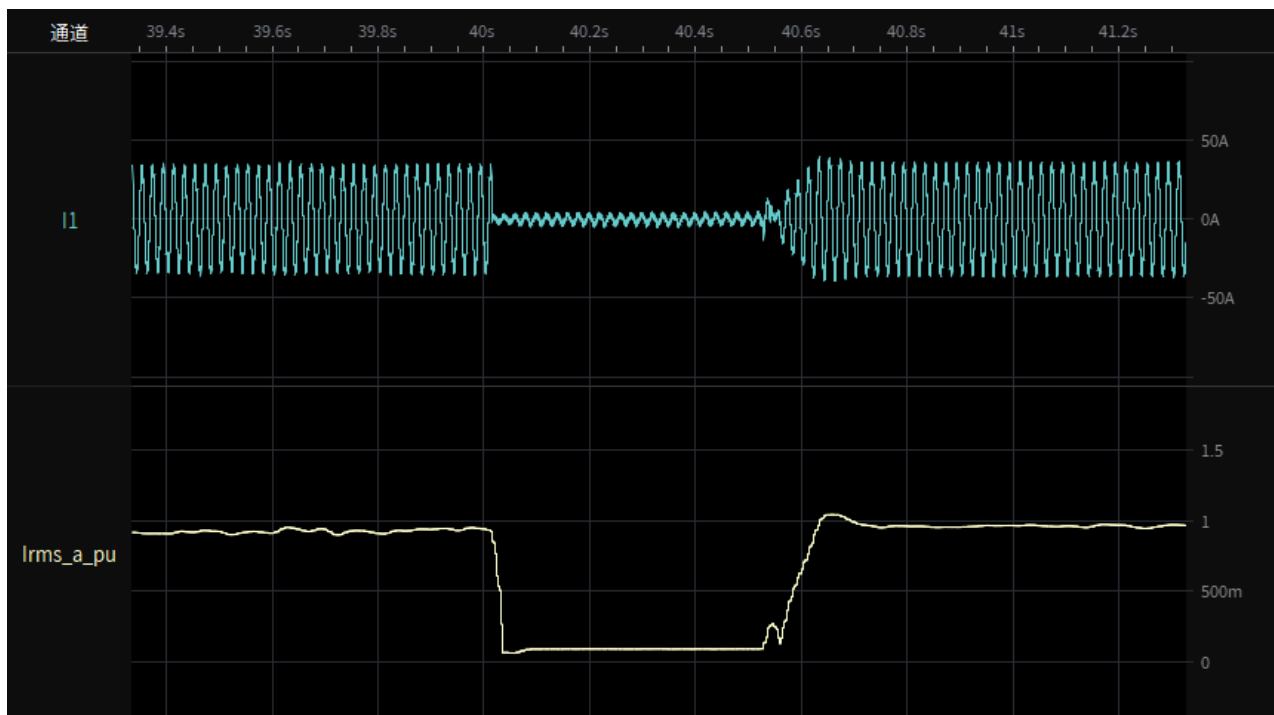

CEI 0-21			
Clause	Requirement - Test	Result - Remark	Verdict

Test 7-2.4 Depth of fault phase: 1.20p.u.,three-phase-symmetrical (type A), 95% load restoring time

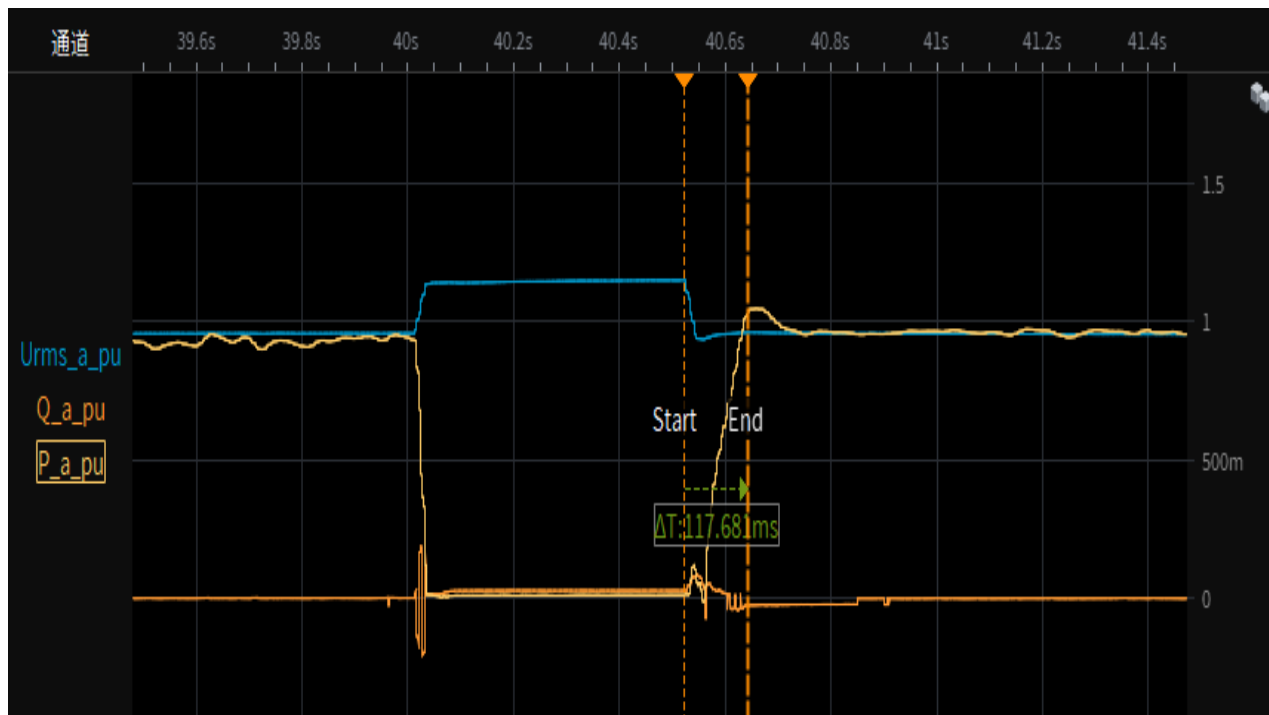

Test 8-Depth of fault phase: 1.25p.u.,three-phase-symmetrical (type A), 0% load Test overview(voltage,current,active and reactive power)

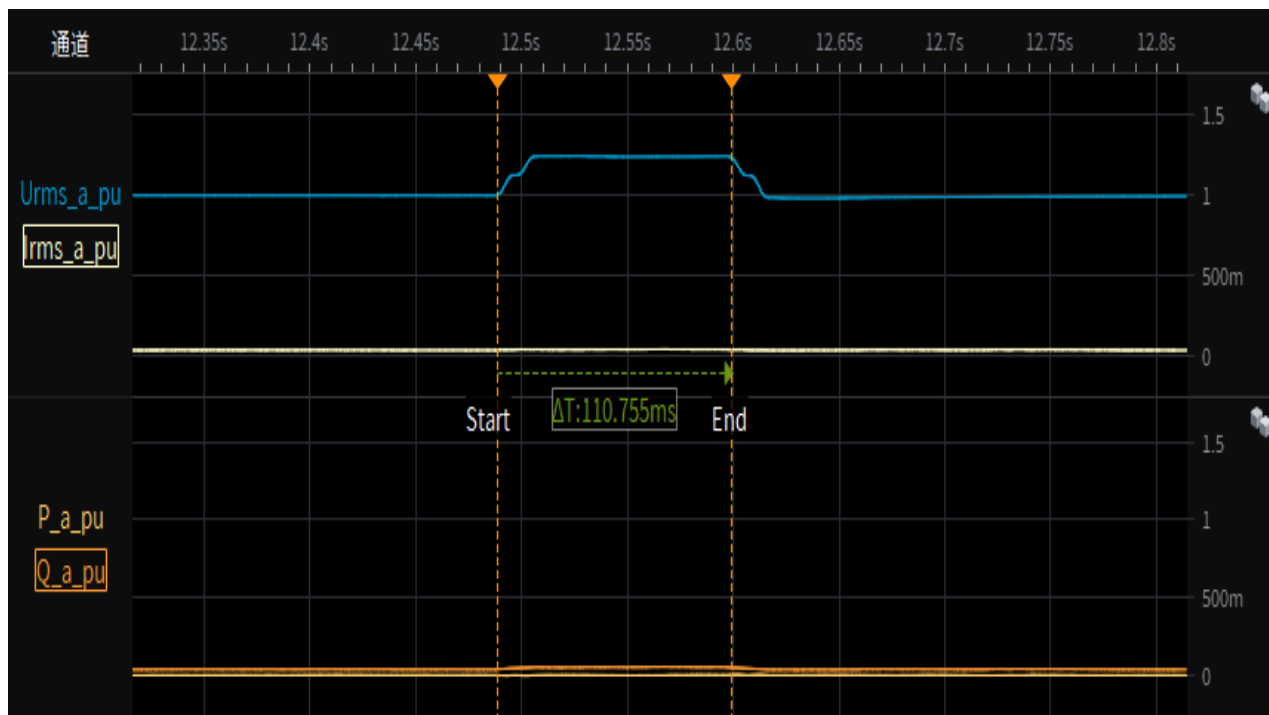

CEI 0-21			
Clause	Requirement - Test	Result - Remark	Verdict

Test 8-1.1 Depth of fault phase: 1.25p.u.,three-phase-symmetrical (type A),20% load
 Test overview(voltage,current,active and reactive power)

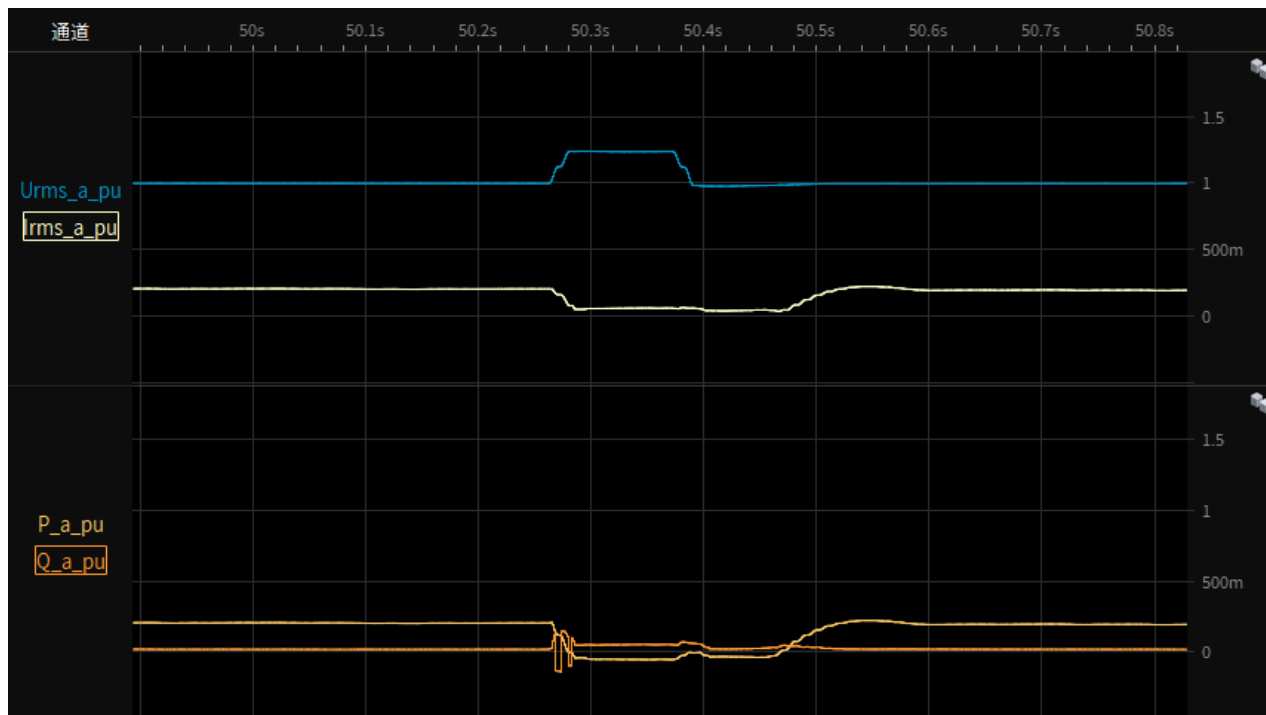

Test 8-1.2 Depth of fault phase: 1.25p.u.,three-phase-symmetrical (type A),20% load
 Instantaneous curve and RMS value of phase-to-neutral voltages

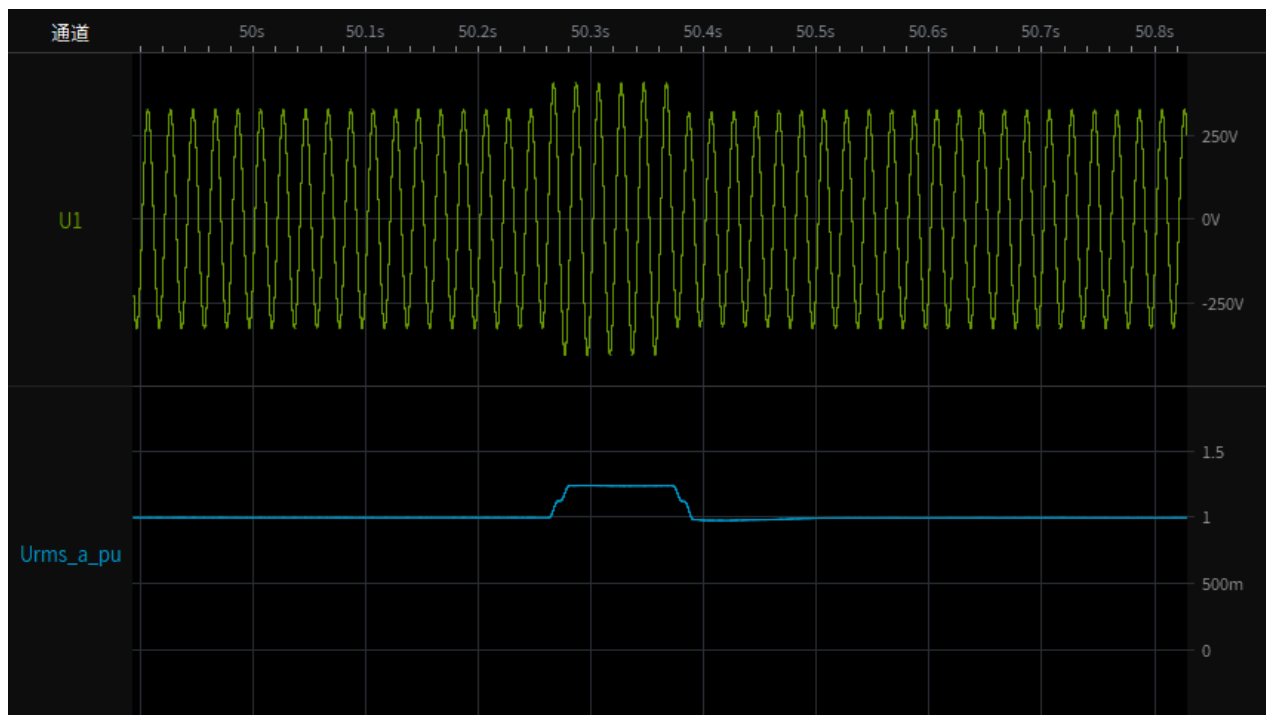

CEI 0-21			
Clause	Requirement - Test	Result - Remark	Verdict

Test 8-1.3 Depth of fault phase: 1.25p.u.,three-phase-symmetrical (type A),20% load
Instantaneous curve and RMS value of phase currents

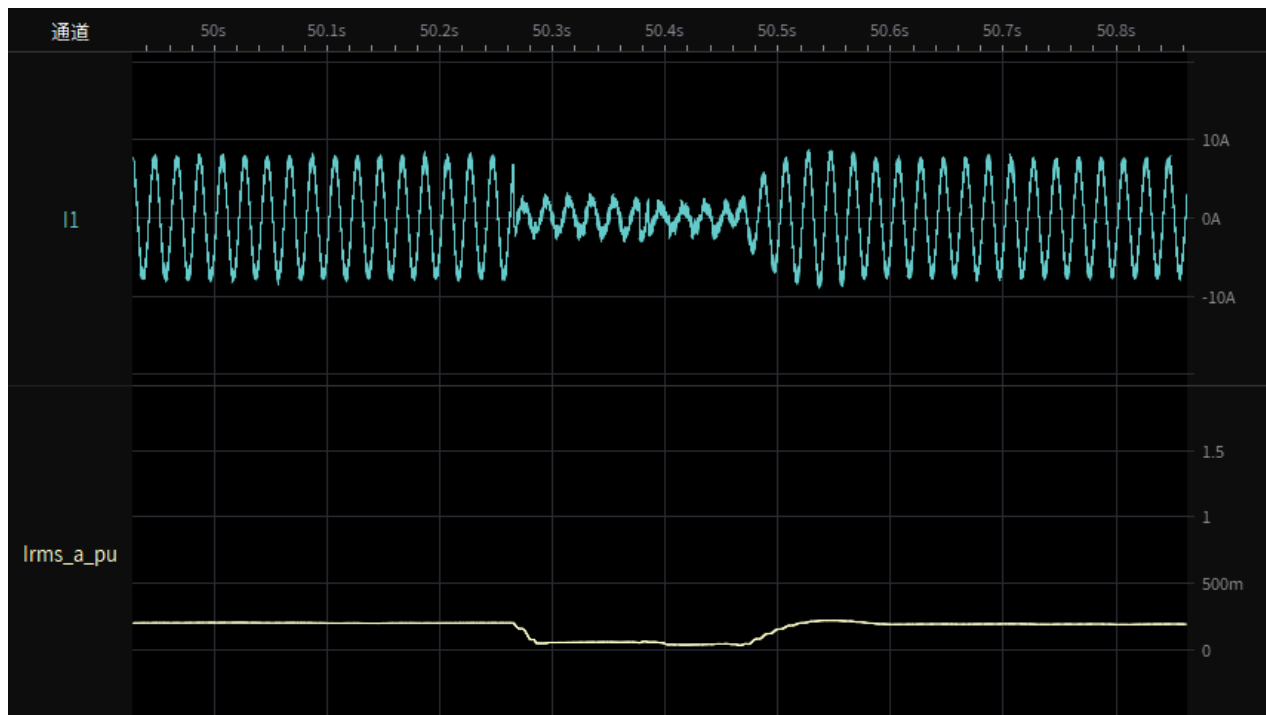

Test 8-1.4 Depth of fault phase: 1.25p.u.,three-phase-symmetrical (type A),20% load
restoring time

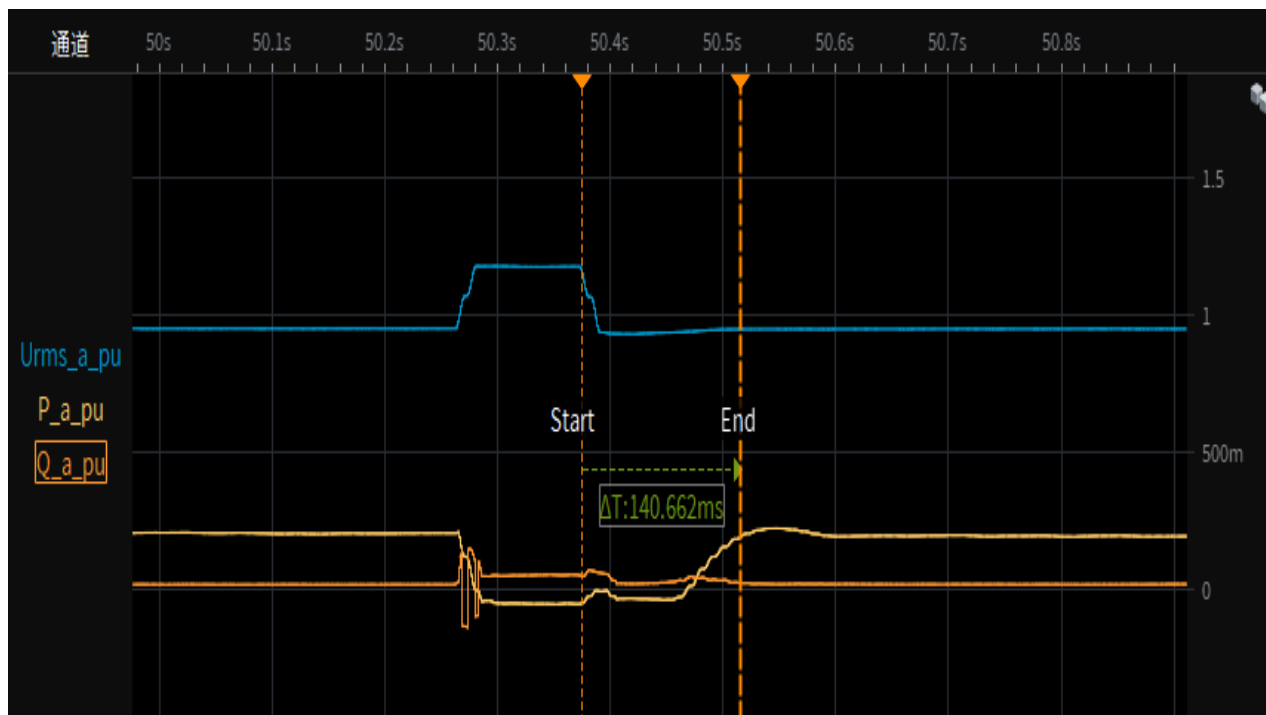

CEI 0-21			
Clause	Requirement - Test	Result - Remark	Verdict

Test 8-2.1 Depth of fault phase: 1.25p.u.,three-phase-symmetrical (type A),95% load
Test overview(voltage,current,active and reactive power)

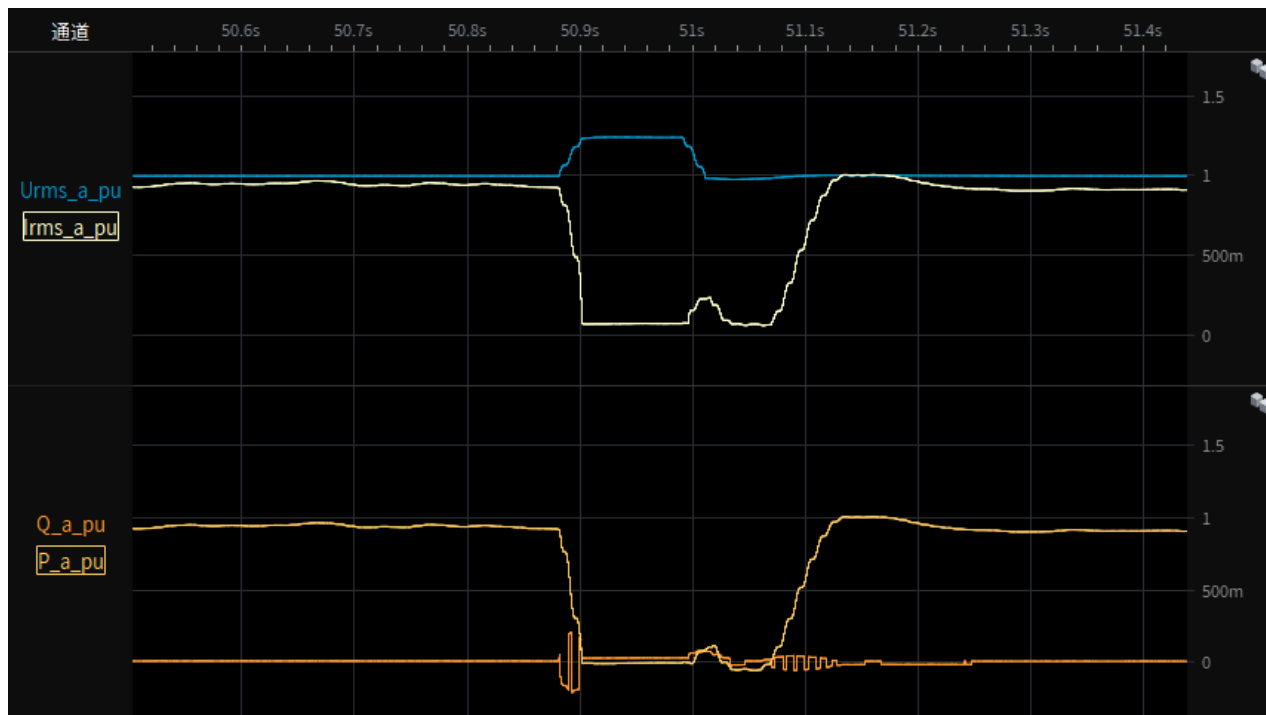

Test 8-2.2 Depth of fault phase: 1.25p.u.,three-phase-symmetrical (type A),95% load
Instantaneous curve and RMS value of phase-to-neutral voltages

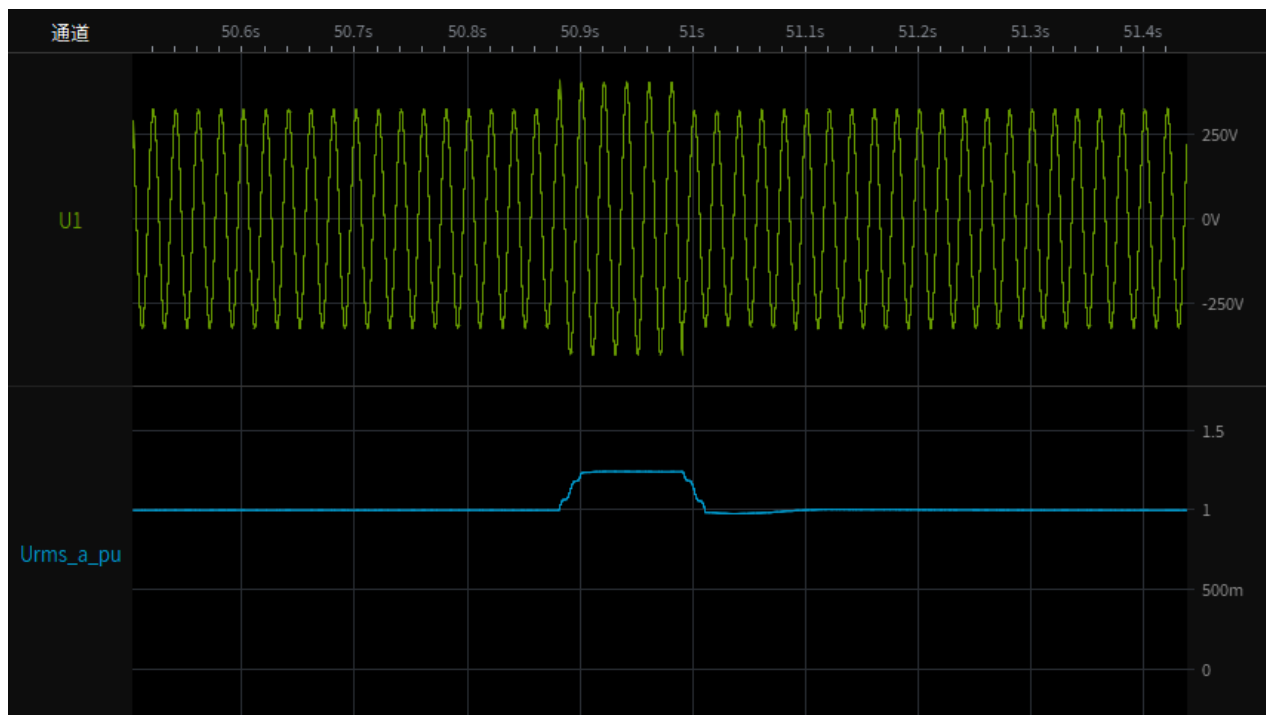

CEI 0-21			
Clause	Requirement - Test	Result - Remark	Verdict

Test 8-2.3 Depth of fault phase: 1.25p.u., three-phase-symmetrical (type A), 95% load
Instantaneous curve and RMS value of phase currents

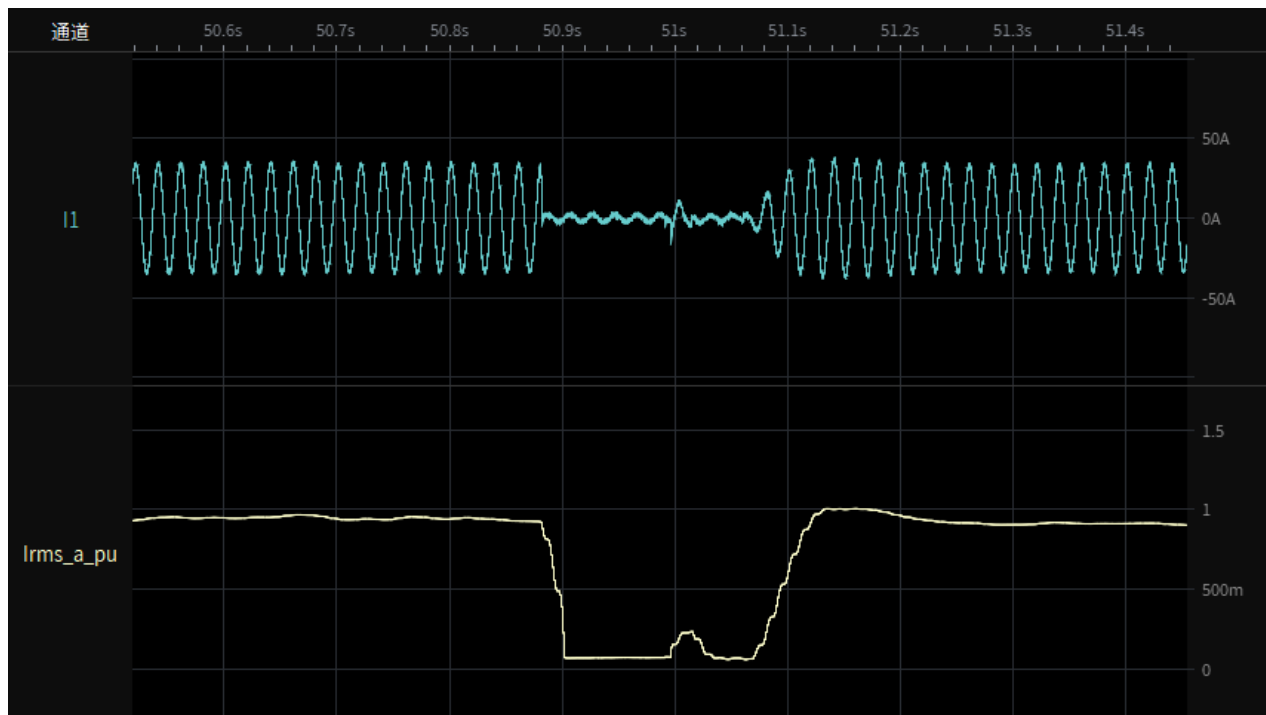

Test 8-2.4 Depth of fault phase: 1.25p.u., three-phase-symmetrical (type A), 95% load
restoring time

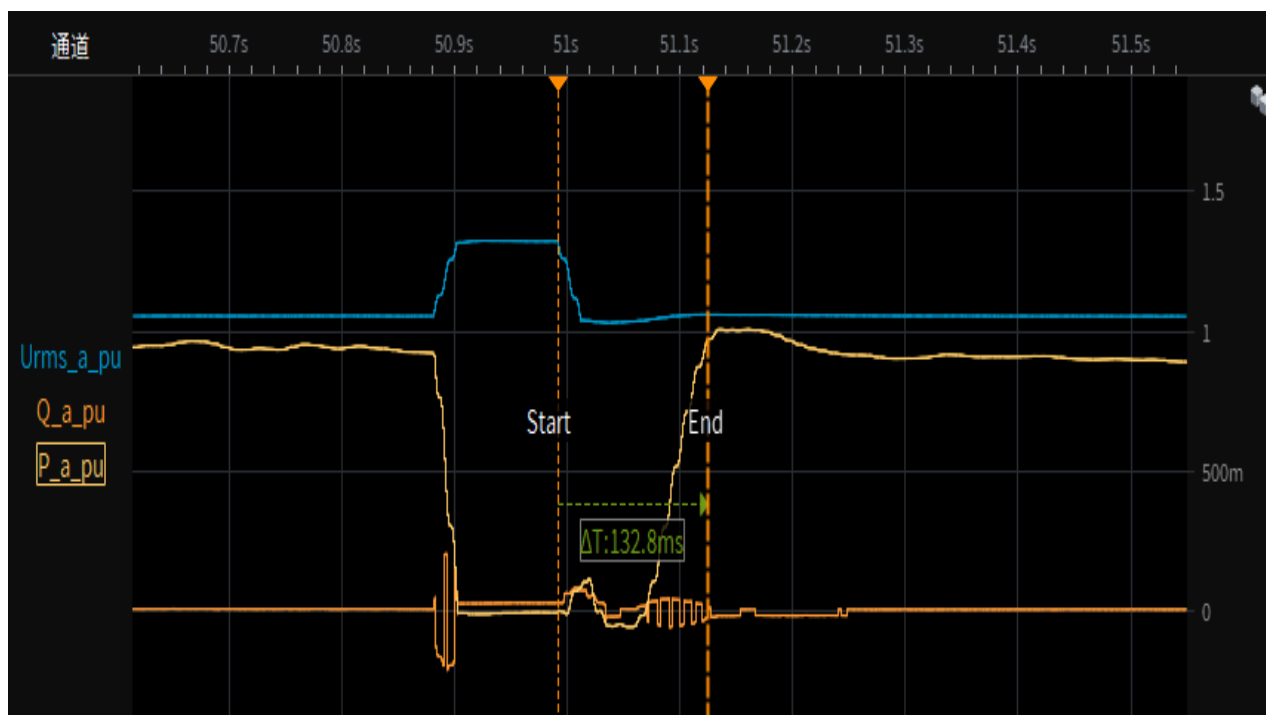

CEI 0-21			
Clause	Requirement - Test	Result - Remark	Verdict

B.1.6	TABLE: Checking the insensitivity to automatic reclosing during phase discordance				P
Model	VT-6607106				
Test 1: Phase angle shift of 90°					
Power level	Cos φ	Phase shift angle (°)	Current 20 ms before phase shift (A)	Current 200ms after phase shif (A)	Result
100%	0.999	90	25.68	26.00	The PV inverter continue to feed power to grid after phase angle shift has been performed. No damage, no hazard.
Test 2: Phase angle shift of 180°					
Power level (%)	Cos φ	Phase shift angle (°)	Current 20 ms before phase shift (A)	Current 200ms after phase shif (A)	Result
100%	0.999	180	25.82	26.92	The PV inverter continue to feed power to grid after phase angle shift has been performed. No damage, no hazard.
Note:					
The generator must be brought into operation at rated power. Let the system operate under the set conditions for at least 5 min or the time necessary for the temperature inside the converter to stabilize.					
The inverter should be operated with $\cos \varphi = 1$ and nominal output power. The network simulator should create voltage phase shifts of 90° and 180°. As a result, 20ms before and 200ms after the voltage phase shift, should be documented.					

CEI 0-21			
Clause	Requirement - Test	Result - Remark	Verdict

Diagram: shift of 90°

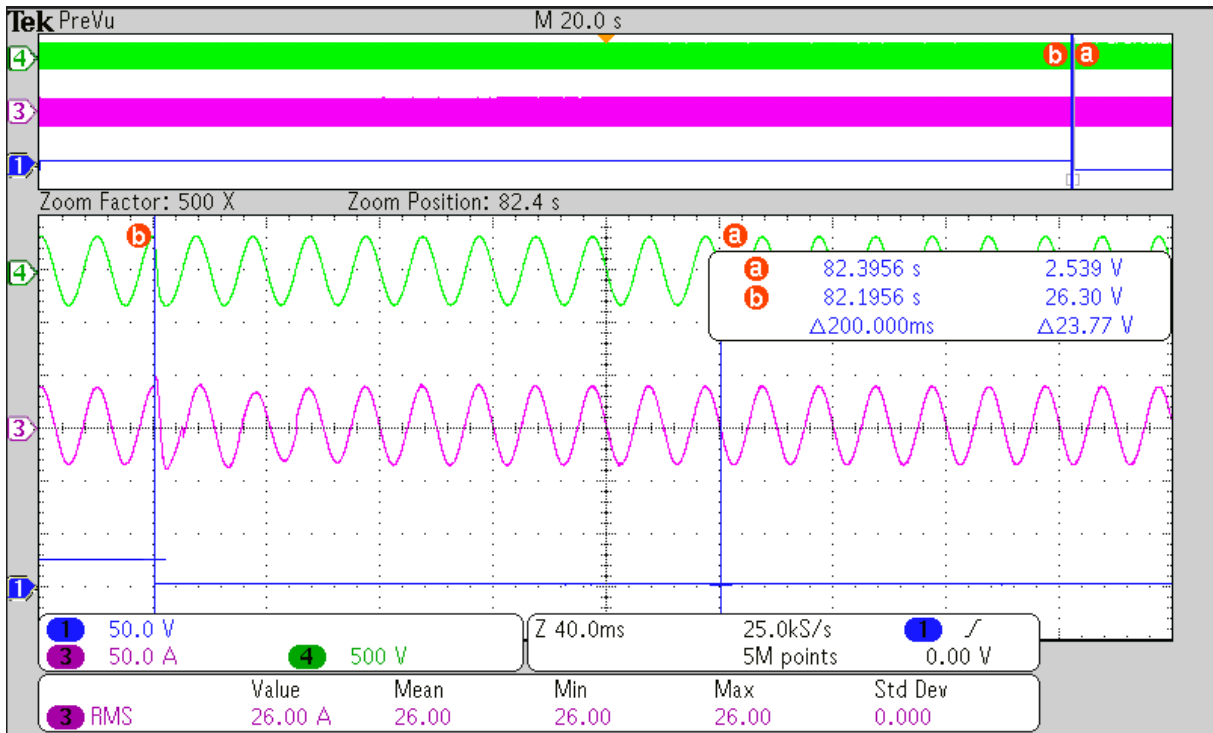
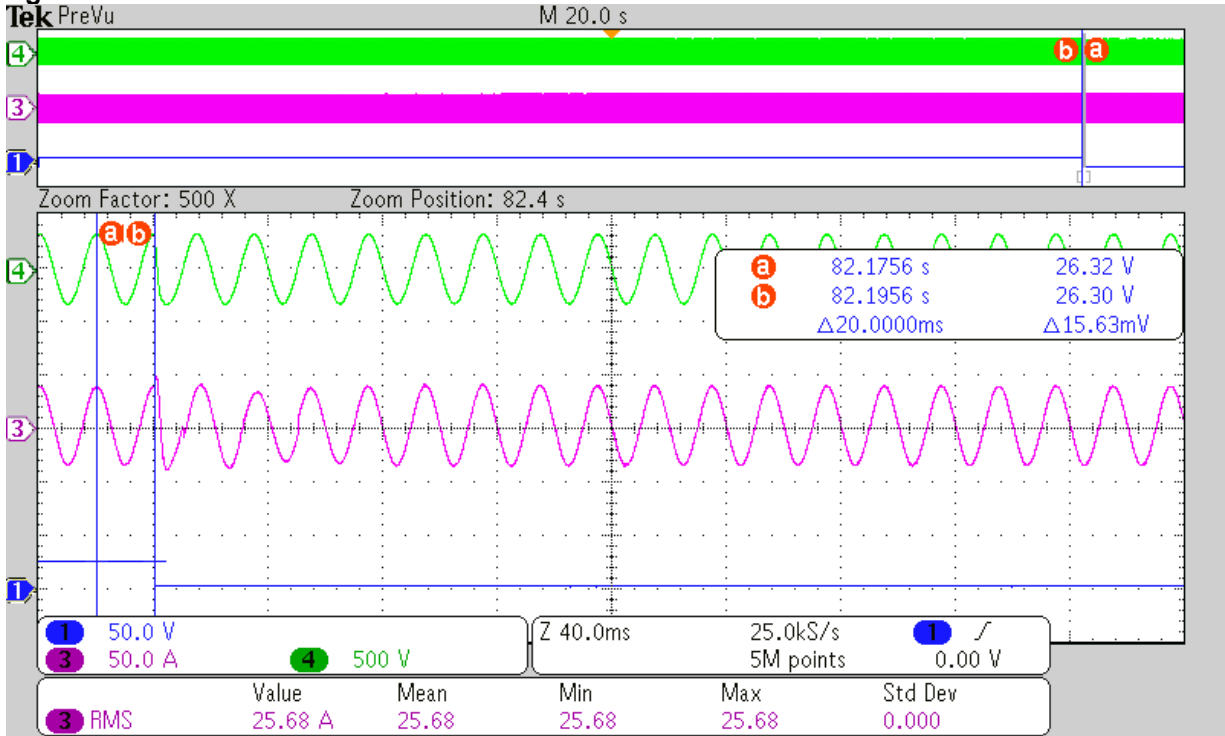

CEI 0-21			
Clause	Requirement - Test	Result - Remark	Verdict

Diagram: shift of 180°

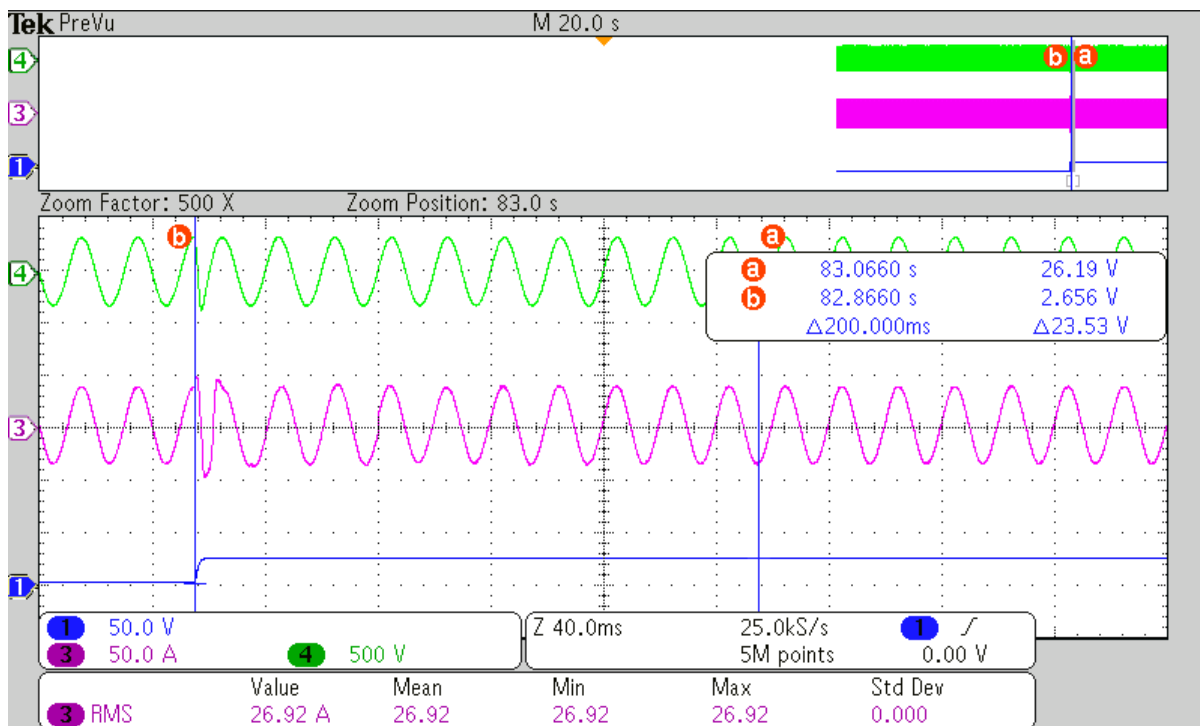
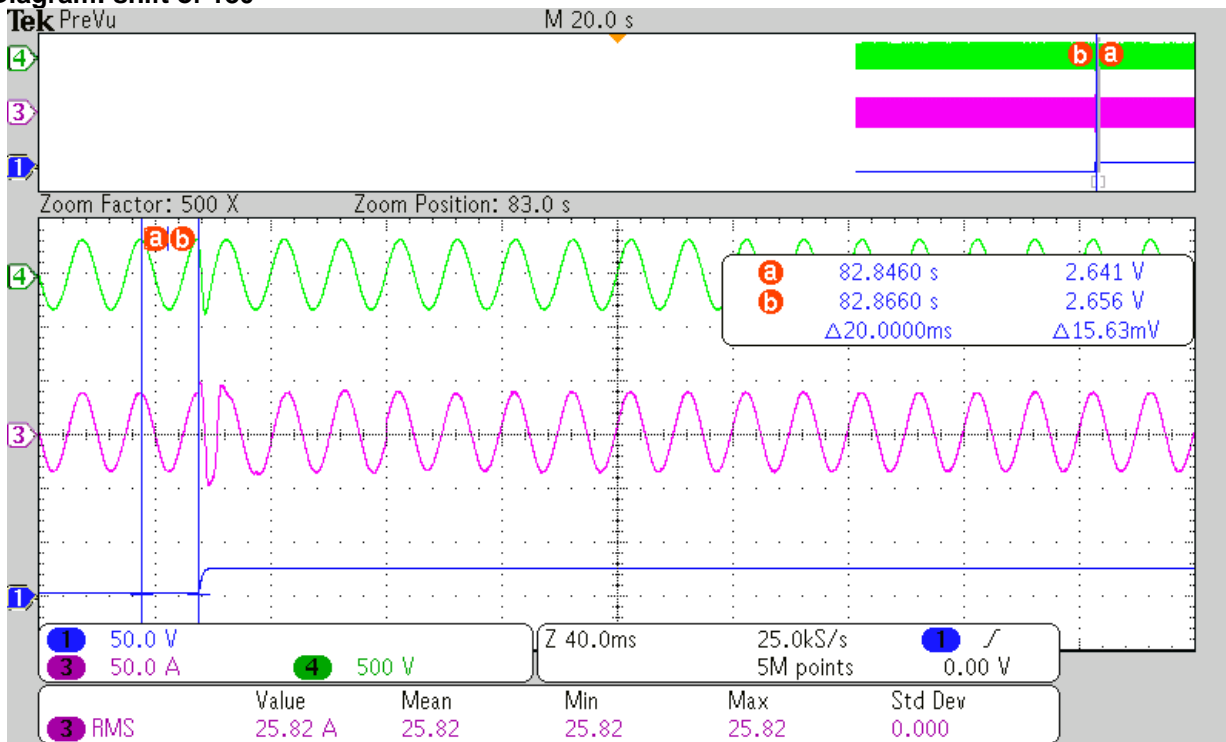

CEI 0-21			
Clause	Requirement - Test	Result - Remark	Verdict
Bbis.3 a)/b)	TABLE: Harmonics measurement		P
Mode	VT-6607106		
<input checked="" type="checkbox"/> CEI EN 61000-3-2			
<input checked="" type="checkbox"/> CEI EN 61000-3-12			
<input checked="" type="checkbox"/> Ambient temperature			
<input checked="" type="checkbox"/> -25°C temperature			
<input checked="" type="checkbox"/> +60°C temperature			
<input checked="" type="checkbox"/> Full power, 66% and 33% of P_{SMAX} / P_{NINV}			
<input checked="" type="checkbox"/> Full power, 66% and 33% of P_{CMAX}			
<p>a) harmonic emission limits, for class A (CEI EN 61000-3-2 or CEI EN 61000-3-12); they must be repeated, for storage systems connected to bidirectional converters, in 6 sessions (at 33%, 66% and 100% of the P_{SMAX}, or P_{NINV} for integrated EESS, and at 33%, 66% and 100% of the P_{CMAX}), and for storage systems connected to unidirectional converters in 3 sessions (at 33%, 66% and 100% of the maximum available discharge power);</p> <p>b) for devices with phase currents higher than 75 A, it is possible to carry out harmonic emission tests with the same criteria provided for by CEI EN 61000-3-12; they must be repeated, for storage systems connected to bidirectional converters, in 6 sessions (at 33%, 66% and 100% of the P_{SMAX}, or P_{NINV} for integrated EESS, and at 33%, 66% and 100% of the P_{CMAX}), and for storage systems connected to unidirectional converters in 3 sessions (at 33%, 66% and 100% of the maximum available discharge power)</p>			
Supplementary information:			
*If the EUT operating temperature out of -10°C to 55°C, please use the upper and lower operating temperature limit in the test.			

CEI 0-21			
Clause	Requirement - Test	Result - Remark	Verdict

Bbis.3	TABLE: Harmonics measurement under test condition 25°C /-25°C / 60°C, 100% / 66%/ 33% P _S MAX and P _C MAX (CEI EN 61000-3-12)			P
Model	VT-6607106+16Battery			
Active power (W)	-4088.95 (60°C)			
Voltage (V)	229.72			
Current (A)	17.89			
Power Factor	-0.995			
Frequency (Hz)	50.00			
Harmonics	Current Magnitude (A)	Current Percent of Fundamental (%)	Phase	Harmonic Current Limits (%)
1st	17.884	--	Single phase	--
2nd	0.020	0.110	Single phase	8
3rd	0.394	2.199	Single phase	21,6
4th	0.031	0.174	Single phase	4
5th	0.298	1.663	Single phase	10,7
6th	0.007	0.037	Single phase	2,7
7th	0.207	1.155	Single phase	7,2
8th	0.013	0.074	Single phase	2
9th	0.153	0.856	Single phase	3,8
10th	0.018	0.100	Single phase	1,6
11th	0.116	0.647	Single phase	3,1
12th	0.026	0.146	Single phase	1,3
13th	0.075	0.419	Single phase	2
14th	0.025	0.137	Single phase	N/A
15th	0.061	0.343	Single phase	N/A
16th	0.020	0.109	Single phase	N/A
17th	0.056	0.314	Single phase	N/A
18th	0.020	0.112	Single phase	N/A
19th	0.042	0.235	Single phase	N/A
20th	0.007	0.038	Single phase	N/A
21st	0.022	0.126	Single phase	N/A
22nd	0.017	0.096	Single phase	N/A
23rd	0.019	0.104	Single phase	N/A
24th	0.007	0.041	Single phase	N/A
25th	0.021	0.115	Single phase	N/A
26th	0.004	0.020	Single phase	N/A
27th	0.017	0.097	Single phase	N/A
28th	0.003	0.014	Single phase	N/A
29th	0.011	0.060	Single phase	N/A
30th	0.007	0.042	Single phase	N/A
31st	0.011	0.059	Single phase	N/A
32nd	0.003	0.019	Single phase	N/A
33rd	0.011	0.061	Single phase	N/A
34th	0.005	0.030	Single phase	N/A
35th	0.008	0.043	Single phase	N/A
36th	0.006	0.035	Single phase	N/A
37th	0.008	0.043	Single phase	N/A
38th	0.005	0.027	Single phase	N/A
39th	0.006	0.034	Single phase	N/A
40th	0.004	0.023	Single phase	N/A
THD	--	3.323	Single phase	23
PWHD	--	2.710	Single phase	23

CEI 0-21			
Clause	Requirement - Test	Result - Remark	Verdict

Bbis.3	TABLE: Harmonics measurement under test condition 25°C /-25°C / 60°C, 100% / 66%/ 33% P _S MAX and P _C MAX (CEI EN 61000-3-12)			P
Model	VT-6607106+16Battery			
Active power (W)	-4089.50 (-25°C)			
Voltage (V)	229.71			
Current (A)	17.90			
Power Factor	-0.995			
Frequency (Hz)	50.00			
Harmonics	Current Magnitude (A)	Current Percent of Fundamental (%)	Phase	Harmonic Current Limits (%)
1st	17.887	--	Single phase	--
2nd	0.022	0.121	Single phase	8
3rd	0.392	2.190	Single phase	21,6
4th	0.033	0.185	Single phase	4
5th	0.295	1.651	Single phase	10,7
6th	0.007	0.037	Single phase	2,7
7th	0.206	1.151	Single phase	7,2
8th	0.013	0.074	Single phase	2
9th	0.152	0.850	Single phase	3,8
10th	0.019	0.108	Single phase	1,6
11th	0.115	0.645	Single phase	3,1
12th	0.027	0.151	Single phase	1,3
13th	0.074	0.415	Single phase	2
14th	0.025	0.139	Single phase	N/A
15th	0.061	0.341	Single phase	N/A
16th	0.019	0.107	Single phase	N/A
17th	0.056	0.311	Single phase	N/A
18th	0.019	0.106	Single phase	N/A
19th	0.042	0.237	Single phase	N/A
20th	0.006	0.034	Single phase	N/A
21st	0.022	0.125	Single phase	N/A
22nd	0.018	0.102	Single phase	N/A
23rd	0.019	0.105	Single phase	N/A
24th	0.008	0.044	Single phase	N/A
25th	0.020	0.113	Single phase	N/A
26th	0.003	0.019	Single phase	N/A
27th	0.018	0.100	Single phase	N/A
28th	0.003	0.015	Single phase	N/A
29th	0.011	0.061	Single phase	N/A
30th	0.008	0.043	Single phase	N/A
31st	0.011	0.062	Single phase	N/A
32nd	0.003	0.019	Single phase	N/A
33rd	0.011	0.061	Single phase	N/A
34th	0.005	0.030	Single phase	N/A
35th	0.008	0.044	Single phase	N/A
36th	0.007	0.037	Single phase	N/A
37th	0.008	0.043	Single phase	N/A
38th	0.005	0.027	Single phase	N/A
39th	0.006	0.036	Single phase	N/A
40th	0.004	0.023	Single phase	N/A
THD	--	3.302	Single phase	23
PWHD	--	2.709	Single phase	23

CEI 0-21			
Clause	Requirement - Test	Result - Remark	Verdict

Bbis.3	TABLE: Harmonics measurement under test condition 25°C /-25°C / 60°C, 100%/ 66%/ 33% P_SMAX and P_CMAX (CEI EN 61000-3-12)			P
Model	VT-6607106+16Battery			
Active power (W)	-4089.65 (25°C)			
Voltage (V)	229.71			
Current (A)	17.90			
Power Factor	-0.995			
Frequency (Hz)	50.00			
Harmonics	Current Magnitude (A)	Current Percent of Fundamental (%)	Phase	Harmonic Current Limits (%)
1st	17.887	--	Single phase	--
2nd	0.024	0.134	Single phase	8
3rd	0.391	2.184	Single phase	21,6
4th	0.035	0.196	Single phase	4
5th	0.294	1.644	Single phase	10,7
6th	0.007	0.042	Single phase	2,7
7th	0.205	1.144	Single phase	7,2
8th	0.014	0.081	Single phase	2
9th	0.152	0.848	Single phase	3,8
10th	0.022	0.120	Single phase	1,6
11th	0.115	0.642	Single phase	3,1
12th	0.028	0.156	Single phase	1,3
13th	0.074	0.414	Single phase	2
14th	0.026	0.145	Single phase	N/A
15th	0.061	0.342	Single phase	N/A
16th	0.021	0.116	Single phase	N/A
17th	0.055	0.309	Single phase	N/A
18th	0.019	0.106	Single phase	N/A
19th	0.042	0.236	Single phase	N/A
20th	0.007	0.037	Single phase	N/A
21st	0.023	0.126	Single phase	N/A
22nd	0.019	0.104	Single phase	N/A
23rd	0.019	0.104	Single phase	N/A
24th	0.008	0.047	Single phase	N/A
25th	0.020	0.113	Single phase	N/A
26th	0.004	0.023	Single phase	N/A
27th	0.018	0.099	Single phase	N/A
28th	0.002	0.013	Single phase	N/A
29th	0.011	0.059	Single phase	N/A
30th	0.007	0.041	Single phase	N/A
31st	0.011	0.060	Single phase	N/A
32nd	0.003	0.019	Single phase	N/A
33rd	0.011	0.061	Single phase	N/A
34th	0.006	0.031	Single phase	N/A
35th	0.008	0.043	Single phase	N/A
36th	0.006	0.035	Single phase	N/A
37th	0.008	0.042	Single phase	N/A
38th	0.005	0.026	Single phase	N/A
39th	0.007	0.038	Single phase	N/A
40th	0.004	0.024	Single phase	N/A
THD	--	3.646	Single phase	23
PWHD	--	2.716	Single phase	23

CEI 0-21			
Clause	Requirement - Test	Result - Remark	Verdict

Bbis.3	TABLE: Harmonics measurement under test condition 25°C /-25°C / 60°C, 100%/ 66%/ 33% P_SMAX and P_CMAX (CEI EN 61000-3-12)			P
Model	VT-6607106+16Battery			
Active power (W)	-2730.03 (60°C)			
Voltage (V)	229.59			
Current (A)	11.99			
Power Factor	-0.992			
Frequency (Hz)	50.00			
Harmonics	Current Magnitude (A)	Current Percent of Fundamental (%)	Phase	Harmonic Current Limits (%)
1st	11.978	--	Single phase	--
2nd	0.009	0.076	Single phase	8
3rd	0.344	2.866	Single phase	21,6
4th	0.023	0.194	Single phase	4
5th	0.266	2.221	Single phase	10,7
6th	0.011	0.095	Single phase	2,7
7th	0.175	1.463	Single phase	7,2
8th	0.011	0.091	Single phase	2
9th	0.126	1.048	Single phase	3,8
10th	0.009	0.075	Single phase	1,6
11th	0.093	0.777	Single phase	3,1
12th	0.006	0.051	Single phase	1,3
13th	0.071	0.589	Single phase	2
14th	0.004	0.037	Single phase	N/A
15th	0.043	0.362	Single phase	N/A
16th	0.003	0.027	Single phase	N/A
17th	0.038	0.313	Single phase	N/A
18th	0.007	0.058	Single phase	N/A
19th	0.029	0.243	Single phase	N/A
20th	0.004	0.033	Single phase	N/A
21st	0.016	0.133	Single phase	N/A
22nd	0.009	0.074	Single phase	N/A
23rd	0.014	0.120	Single phase	N/A
24th	0.005	0.043	Single phase	N/A
25th	0.014	0.118	Single phase	N/A
26th	0.003	0.029	Single phase	N/A
27th	0.009	0.072	Single phase	N/A
28th	0.007	0.061	Single phase	N/A
29th	0.009	0.072	Single phase	N/A
30th	0.003	0.027	Single phase	N/A
31st	0.006	0.046	Single phase	N/A
32nd	0.006	0.049	Single phase	N/A
33rd	0.005	0.045	Single phase	N/A
34th	0.004	0.032	Single phase	N/A
35th	0.005	0.045	Single phase	N/A
36th	0.002	0.014	Single phase	N/A
37th	0.004	0.032	Single phase	N/A
38th	0.003	0.024	Single phase	N/A
39th	0.005	0.044	Single phase	N/A
40th	0.002	0.016	Single phase	N/A
THD	--	4.268	Single phase	23
PWHD	--	2.644	Single phase	23

CEI 0-21			
Clause	Requirement - Test	Result - Remark	Verdict

Bbis.3	TABLE: Harmonics measurement under test condition 25°C /-25°C / 60°C, 100%/ 66%/ 33% P_SMAX and P_CMAX (CEI EN 61000-3-12)			P
Model	VT-6607106+16Battery			
Active power (W)	-2730.31 (-25°C)			
Voltage (V)	229.59			
Current (A)	11.99			
Power Factor	-0.992			
Frequency (Hz)	50.00			
Harmonics	Current Magnitude (A)	Current Percent of Fundamental (%)	Phase	Harmonic Current Limits (%)
1st	11.979	--	Single phase	--
2nd	0.008	0.066	Single phase	8
3rd	0.343	2.862	Single phase	21,6
4th	0.023	0.190	Single phase	4
5th	0.266	2.215	Single phase	10,7
6th	0.012	0.101	Single phase	2,7
7th	0.175	1.460	Single phase	7,2
8th	0.011	0.095	Single phase	2
9th	0.126	1.048	Single phase	3,8
10th	0.010	0.080	Single phase	1,6
11th	0.093	0.776	Single phase	3,1
12th	0.006	0.051	Single phase	1,3
13th	0.071	0.589	Single phase	2
14th	0.004	0.037	Single phase	N/A
15th	0.043	0.361	Single phase	N/A
16th	0.004	0.030	Single phase	N/A
17th	0.038	0.313	Single phase	N/A
18th	0.007	0.058	Single phase	N/A
19th	0.029	0.243	Single phase	N/A
20th	0.004	0.035	Single phase	N/A
21st	0.016	0.134	Single phase	N/A
22nd	0.008	0.068	Single phase	N/A
23rd	0.014	0.121	Single phase	N/A
24th	0.005	0.045	Single phase	N/A
25th	0.014	0.120	Single phase	N/A
26th	0.003	0.028	Single phase	N/A
27th	0.009	0.072	Single phase	N/A
28th	0.008	0.064	Single phase	N/A
29th	0.009	0.071	Single phase	N/A
30th	0.003	0.026	Single phase	N/A
31st	0.006	0.048	Single phase	N/A
32nd	0.006	0.050	Single phase	N/A
33rd	0.005	0.043	Single phase	N/A
34th	0.004	0.031	Single phase	N/A
35th	0.005	0.046	Single phase	N/A
36th	0.002	0.014	Single phase	N/A
37th	0.004	0.029	Single phase	N/A
38th	0.003	0.025	Single phase	N/A
39th	0.005	0.043	Single phase	N/A
40th	0.002	0.015	Single phase	N/A
THD	--	4.264	Single phase	23
PWHD	--	2.647	Single phase	23

CEI 0-21			
Clause	Requirement - Test	Result - Remark	Verdict

Bbis.3	TABLE: Harmonics measurement under test condition 25°C /- 25°C / 60°C, 100% / 66% / 33% P _S MAX and P _C MAX (CEI EN 61000-3-12)			P
Model	VT-6607106+16Battery			
Active power (W)	-2730.59 (25°C)			
Voltage (V)	229.58			
Current (A)	11.99			
Power Factor	-0.992			
Frequency (Hz)	50.00			
Harmonics	Current Magnitude (A)	Current Percent of Fundamental (%)	Phase	Harmonic Current Limits (%)
1st	11.980	--	Single phase	--
2nd	0.008	0.065	Single phase	8
3rd	0.343	2.859	Single phase	21,6
4th	0.023	0.188	Single phase	4
5th	0.265	2.210	Single phase	10,7
6th	0.012	0.102	Single phase	2,7
7th	0.175	1.462	Single phase	7,2
8th	0.011	0.095	Single phase	2
9th	0.126	1.047	Single phase	3,8
10th	0.010	0.083	Single phase	1,6
11th	0.093	0.777	Single phase	3,1
12th	0.006	0.050	Single phase	1,3
13th	0.071	0.590	Single phase	2
14th	0.004	0.037	Single phase	N/A
15th	0.043	0.363	Single phase	N/A
16th	0.003	0.028	Single phase	N/A
17th	0.037	0.313	Single phase	N/A
18th	0.007	0.059	Single phase	N/A
19th	0.029	0.243	Single phase	N/A
20th	0.004	0.036	Single phase	N/A
21st	0.016	0.132	Single phase	N/A
22nd	0.008	0.065	Single phase	N/A
23rd	0.014	0.119	Single phase	N/A
24th	0.005	0.046	Single phase	N/A
25th	0.014	0.116	Single phase	N/A
26th	0.003	0.029	Single phase	N/A
27th	0.008	0.070	Single phase	N/A
28th	0.008	0.065	Single phase	N/A
29th	0.009	0.072	Single phase	N/A
30th	0.004	0.030	Single phase	N/A
31st	0.006	0.049	Single phase	N/A
32nd	0.006	0.051	Single phase	N/A
33rd	0.005	0.044	Single phase	N/A
34th	0.004	0.033	Single phase	N/A
35th	0.006	0.047	Single phase	N/A
36th	0.004	0.030	Single phase	N/A
37th	0.004	0.034	Single phase	N/A
38th	0.003	0.026	Single phase	N/A
39th	0.005	0.043	Single phase	N/A
40th	0.002	0.017	Single phase	N/A
THD	--	4.248	Single phase	23
PWHD	--	2.651	Single phase	23

CEI 0-21			
Clause	Requirement - Test	Result - Remark	Verdict

Bbis.3	TABLE: Harmonics measurement under test condition 25°C /- 25°C / 60°C, 100% / 66% / 33% P _S MAX and P _C MAX (CEI EN 61000-3-12)			P
Model	VT-6607106+16Battery			
Active power (W)	-1360.34 (60°C)			
Voltage (V)	229.47			
Current (A)	6.08			
Power Factor	-0.975			
Frequency (Hz)	50.00			
Harmonics	Current Magnitude (A)	Current Percent of Fundamental (%)	Phase	Harmonic Current Limits (%)
1st	6.064	--	Single phase	--
2nd	0.007	0.121	Single phase	8
3rd	0.337	5.537	Single phase	21,6
4th	0.012	0.205	Single phase	4
5th	0.205	3.367	Single phase	10,7
6th	0.010	0.164	Single phase	2,7
7th	0.107	1.766	Single phase	7,2
8th	0.015	0.250	Single phase	2
9th	0.060	0.991	Single phase	3,8
10th	0.013	0.221	Single phase	1,6
11th	0.029	0.479	Single phase	3,1
12th	0.012	0.192	Single phase	1,3
13th	0.007	0.107	Single phase	2
14th	0.011	0.175	Single phase	N/A
15th	0.008	0.126	Single phase	N/A
16th	0.008	0.135	Single phase	N/A
17th	0.007	0.114	Single phase	N/A
18th	0.002	0.030	Single phase	N/A
19th	0.011	0.177	Single phase	N/A
20th	0.010	0.160	Single phase	N/A
21st	0.011	0.186	Single phase	N/A
22nd	0.011	0.174	Single phase	N/A
23rd	0.009	0.146	Single phase	N/A
24th	0.007	0.115	Single phase	N/A
25th	0.010	0.172	Single phase	N/A
26th	0.002	0.030	Single phase	N/A
27th	0.009	0.145	Single phase	N/A
28th	0.005	0.088	Single phase	N/A
29th	0.005	0.076	Single phase	N/A
30th	0.003	0.047	Single phase	N/A
31st	0.004	0.067	Single phase	N/A
32nd	0.002	0.031	Single phase	N/A
33rd	0.003	0.044	Single phase	N/A
34th	0.002	0.041	Single phase	N/A
35th	0.003	0.051	Single phase	N/A
36th	0.004	0.069	Single phase	N/A
37th	0.002	0.033	Single phase	N/A
38th	0.003	0.046	Single phase	N/A
39th	0.003	0.057	Single phase	N/A
40th	0.002	0.031	Single phase	N/A
THD	--	6.969	Single phase	23
PWHD	--	2.675	Single phase	23

CEI 0-21			
Clause	Requirement - Test	Result - Remark	Verdict

Bbis.3	TABLE: Harmonics measurement under test condition 25°C /-25°C / 60°C, 100%/ 66%/ 33% P_SMAX and P_CMAX (CEI EN 61000-3-12)			P
Model	VT-6607106+16Battery			
Active power (W)	-1360.24 (-25°C)			
Voltage (V)	229.48			
Current (A)	6.08			
Power Factor	-0.975			
Frequency (Hz)	50.00			
Harmonics	Current Magnitude (A)	Current Percent of Fundamental (%)	Phase	Harmonic Current Limits (%)
1st	6.063	--	Single phase	--
2nd	0.007	0.122	Single phase	8
3rd	0.337	5.547	Single phase	21,6
4th	0.013	0.206	Single phase	4
5th	0.205	3.370	Single phase	10,7
6th	0.010	0.157	Single phase	2,7
7th	0.108	1.774	Single phase	7,2
8th	0.015	0.248	Single phase	2
9th	0.060	0.988	Single phase	3,8
10th	0.013	0.220	Single phase	1,6
11th	0.029	0.483	Single phase	3,1
12th	0.012	0.192	Single phase	1,3
13th	0.007	0.108	Single phase	2
14th	0.011	0.175	Single phase	N/A
15th	0.007	0.123	Single phase	N/A
16th	0.008	0.134	Single phase	N/A
17th	0.007	0.117	Single phase	N/A
18th	0.002	0.034	Single phase	N/A
19th	0.011	0.177	Single phase	N/A
20th	0.010	0.161	Single phase	N/A
21st	0.012	0.190	Single phase	N/A
22nd	0.011	0.175	Single phase	N/A
23rd	0.009	0.155	Single phase	N/A
24th	0.007	0.118	Single phase	N/A
25th	0.011	0.179	Single phase	N/A
26th	0.002	0.037	Single phase	N/A
27th	0.009	0.150	Single phase	N/A
28th	0.005	0.087	Single phase	N/A
29th	0.004	0.074	Single phase	N/A
30th	0.003	0.048	Single phase	N/A
31st	0.004	0.066	Single phase	N/A
32nd	0.002	0.033	Single phase	N/A
33rd	0.002	0.036	Single phase	N/A
34th	0.003	0.043	Single phase	N/A
35th	0.003	0.051	Single phase	N/A
36th	0.007	0.123	Single phase	N/A
37th	0.002	0.033	Single phase	N/A
38th	0.003	0.048	Single phase	N/A
39th	0.003	0.054	Single phase	N/A
40th	0.002	0.028	Single phase	N/A
THD	--	6.968	Single phase	23
PWHD	--	2.782	Single phase	23

CEI 0-21			
Clause	Requirement - Test	Result - Remark	Verdict

Bbis.3	TABLE: Harmonics measurement under test condition 25°C /-25°C / 60°C, 100%/ 66%/ 33% P_SMAX and P_CMAX (CEI EN 61000-3-12)			P
Model	VT-6607106+16Battery			
Active power (W)	-1360.51 (25°C)			
Voltage (V)	229.46			
Current (A)	6.08			
Power Factor	-0.975			
Frequency (Hz)	50.00			
Harmonics	Current Magnitude (A)	Current Percent of Fundamental (%)	Phase	Harmonic Current Limits (%)
1st	6.064	--	Single phase	--
2nd	0.007	0.115	Single phase	8
3rd	0.337	5.545	Single phase	21,6
4th	0.013	0.210	Single phase	4
5th	0.205	3.376	Single phase	10,7
6th	0.010	0.161	Single phase	2,7
7th	0.108	1.771	Single phase	7,2
8th	0.015	0.248	Single phase	2
9th	0.061	0.997	Single phase	3,8
10th	0.013	0.219	Single phase	1,6
11th	0.029	0.483	Single phase	3,1
12th	0.012	0.192	Single phase	1,3
13th	0.007	0.109	Single phase	2
14th	0.011	0.176	Single phase	N/A
15th	0.007	0.123	Single phase	N/A
16th	0.008	0.135	Single phase	N/A
17th	0.007	0.119	Single phase	N/A
18th	0.002	0.032	Single phase	N/A
19th	0.011	0.180	Single phase	N/A
20th	0.010	0.158	Single phase	N/A
21st	0.011	0.188	Single phase	N/A
22nd	0.010	0.171	Single phase	N/A
23rd	0.009	0.151	Single phase	N/A
24th	0.007	0.115	Single phase	N/A
25th	0.011	0.175	Single phase	N/A
26th	0.002	0.034	Single phase	N/A
27th	0.009	0.150	Single phase	N/A
28th	0.005	0.088	Single phase	N/A
29th	0.005	0.079	Single phase	N/A
30th	0.003	0.046	Single phase	N/A
31st	0.004	0.060	Single phase	N/A
32nd	0.002	0.030	Single phase	N/A
33rd	0.002	0.039	Single phase	N/A
34th	0.003	0.046	Single phase	N/A
35th	0.003	0.054	Single phase	N/A
36th	0.003	0.056	Single phase	N/A
37th	0.002	0.034	Single phase	N/A
38th	0.003	0.045	Single phase	N/A
39th	0.003	0.056	Single phase	N/A
40th	0.002	0.028	Single phase	N/A
THD	--	6.966	Single phase	23
PWHD	--	2.683	Single phase	23

CEI 0-21			
Clause	Requirement - Test	Result - Remark	Verdict

Bbis.3	TABLE: Harmonics measurement under test condition 25°C /-25°C / 60°C, 100%/ 66%/ 33% P _S MAX and P _C MAX (CEI EN 61000-3-12)			P
Model	VT-6607106+16Battery			
Active power (W)	4090.17 (60°C)			
Voltage (V)	229.70			
Current (A)	17.90			
Power Factor	0.995			
Frequency (Hz)	50.00			
Harmonics	Current Magnitude (A)	Current Percent of Fundamental (%)	Phase	Harmonic Current Limits (%)
1st	17.891	--	Single phase	--
2nd	0.023	0.130	Single phase	8
3rd	0.390	2.178	Single phase	21,6
4th	0.035	0.195	Single phase	4
5th	0.294	1.640	Single phase	10,7
6th	0.005	0.029	Single phase	2,7
7th	0.204	1.142	Single phase	7,2
8th	0.013	0.072	Single phase	2
9th	0.151	0.846	Single phase	3,8
10th	0.021	0.119	Single phase	1,6
11th	0.115	0.642	Single phase	3,1
12th	0.028	0.154	Single phase	1,3
13th	0.074	0.412	Single phase	2
14th	0.025	0.141	Single phase	N/A
15th	0.061	0.343	Single phase	N/A
16th	0.019	0.107	Single phase	N/A
17th	0.055	0.308	Single phase	N/A
18th	0.018	0.102	Single phase	N/A
19th	0.043	0.238	Single phase	N/A
20th	0.005	0.030	Single phase	N/A
21st	0.023	0.126	Single phase	N/A
22nd	0.020	0.112	Single phase	N/A
23rd	0.019	0.104	Single phase	N/A
24th	0.008	0.044	Single phase	N/A
25th	0.020	0.111	Single phase	N/A
26th	0.004	0.020	Single phase	N/A
27th	0.018	0.101	Single phase	N/A
28th	0.003	0.017	Single phase	N/A
29th	0.011	0.059	Single phase	N/A
30th	0.008	0.046	Single phase	N/A
31st	0.011	0.061	Single phase	N/A
32nd	0.003	0.017	Single phase	N/A
33rd	0.011	0.062	Single phase	N/A
34th	0.006	0.033	Single phase	N/A
35th	0.008	0.042	Single phase	N/A
36th	0.007	0.041	Single phase	N/A
37th	0.007	0.042	Single phase	N/A
38th	0.005	0.025	Single phase	N/A
39th	0.007	0.037	Single phase	N/A
40th	0.004	0.024	Single phase	N/A
THD	--	3.561	Single phase	23
PWHD	--	2.715	Single phase	23

CEI 0-21			
Clause	Requirement - Test	Result - Remark	Verdict

Bbis.3	TABLE: Harmonics measurement under test condition 25°C /-25°C / 60°C, 100% / 66% / 33% P_SMAX and P_CMAX (CEI EN 61000-3-12)			P
Model	VT-6607106+16Battery			
Active power (W)	4090.85 (-25°C)			
Voltage (V)	229.69			
Current (A)	17.90			
Power Factor	0.995			
Frequency (Hz)	50.00			
Harmonics	Current Magnitude (A)	Current Percent of Fundamental (%)	Phase	Harmonic Current Limits (%)
1st	17.894	--	Single phase	--
2nd	0.024	0.132	Single phase	8
3rd	0.389	2.172	Single phase	21,6
4th	0.036	0.198	Single phase	4
5th	0.293	1.637	Single phase	10,7
6th	0.005	0.027	Single phase	2,7
7th	0.204	1.140	Single phase	7,2
8th	0.012	0.070	Single phase	2
9th	0.151	0.844	Single phase	3,8
10th	0.022	0.121	Single phase	1,6
11th	0.115	0.640	Single phase	3,1
12th	0.028	0.155	Single phase	1,3
13th	0.073	0.410	Single phase	2
14th	0.025	0.141	Single phase	N/A
15th	0.061	0.341	Single phase	N/A
16th	0.019	0.104	Single phase	N/A
17th	0.055	0.307	Single phase	N/A
18th	0.018	0.099	Single phase	N/A
19th	0.042	0.237	Single phase	N/A
20th	0.005	0.028	Single phase	N/A
21st	0.023	0.126	Single phase	N/A
22nd	0.021	0.115	Single phase	N/A
23rd	0.019	0.107	Single phase	N/A
24th	0.008	0.045	Single phase	N/A
25th	0.020	0.112	Single phase	N/A
26th	0.004	0.020	Single phase	N/A
27th	0.019	0.103	Single phase	N/A
28th	0.003	0.015	Single phase	N/A
29th	0.011	0.060	Single phase	N/A
30th	0.008	0.042	Single phase	N/A
31st	0.011	0.061	Single phase	N/A
32nd	0.003	0.014	Single phase	N/A
33rd	0.011	0.062	Single phase	N/A
34th	0.006	0.031	Single phase	N/A
35th	0.008	0.043	Single phase	N/A
36th	0.006	0.036	Single phase	N/A
37th	0.008	0.043	Single phase	N/A
38th	0.005	0.027	Single phase	N/A
39th	0.007	0.039	Single phase	N/A
40th	0.004	0.023	Single phase	N/A
THD	--	3.266	Single phase	23
PWHD	--	2.712	Single phase	23

CEI 0-21			
Clause	Requirement - Test	Result - Remark	Verdict

Bbis.3	TABLE: Harmonics measurement under test condition 25°C /-25°C / 60°C, 100% / 66% / 33% P_SMAX and P_CMAX (CEI EN 61000-3-12)			P
Model	VT-6607106+16Battery			
Active power (W)	4090.97 (25°C)			
Voltage (V)	229.68			
Current (A)	17.90			
Power Factor	0.995			
Frequency (Hz)	50.00			
Harmonics	Current Magnitude (A)	Current Percent of Fundamental (%)	Phase	Harmonic Current Limits (%)
1st	17.895	--	Single phase	--
2nd	0.024	0.134	Single phase	8
3rd	0.388	2.169	Single phase	21,6
4th	0.036	0.202	Single phase	4
5th	0.293	1.634	Single phase	10,7
6th	0.005	0.025	Single phase	2,7
7th	0.203	1.136	Single phase	7,2
8th	0.012	0.070	Single phase	2
9th	0.151	0.844	Single phase	3,8
10th	0.022	0.122	Single phase	1,6
11th	0.115	0.640	Single phase	3,1
12th	0.028	0.156	Single phase	1,3
13th	0.073	0.410	Single phase	2
14th	0.025	0.139	Single phase	N/A
15th	0.061	0.342	Single phase	N/A
16th	0.018	0.102	Single phase	N/A
17th	0.055	0.307	Single phase	N/A
18th	0.017	0.098	Single phase	N/A
19th	0.043	0.239	Single phase	N/A
20th	0.005	0.027	Single phase	N/A
21st	0.022	0.126	Single phase	N/A
22nd	0.021	0.119	Single phase	N/A
23rd	0.019	0.105	Single phase	N/A
24th	0.008	0.042	Single phase	N/A
25th	0.020	0.112	Single phase	N/A
26th	0.004	0.020	Single phase	N/A
27th	0.018	0.102	Single phase	N/A
28th	0.003	0.015	Single phase	N/A
29th	0.010	0.058	Single phase	N/A
30th	0.008	0.044	Single phase	N/A
31st	0.011	0.060	Single phase	N/A
32nd	0.003	0.015	Single phase	N/A
33rd	0.011	0.062	Single phase	N/A
34th	0.006	0.033	Single phase	N/A
35th	0.008	0.043	Single phase	N/A
36th	0.006	0.034	Single phase	N/A
37th	0.007	0.041	Single phase	N/A
38th	0.005	0.026	Single phase	N/A
39th	0.007	0.039	Single phase	N/A
40th	0.004	0.024	Single phase	N/A
THD	--	3.272	Single phase	23
PWHD	--	2.710	Single phase	23

CEI 0-21			
Clause	Requirement - Test	Result - Remark	Verdict

Bbis.3	TABLE: Harmonics measurement under test condition 25°C /-25°C / 60°C, 100%/ 66%/ 33% P_SMAX and P_CMAX (CEI EN 61000-3-12)			P
Model	VT-6607106+16Battery			
Active power (W)	2730.57 (60°C)			
Voltage (V)	229.58			
Current (A)	11.99			
Power Factor	0.992			
Frequency (Hz)	50.00			
Harmonics	Current Magnitude (A)	Current Percent of Fundamental (%)	Phase	Harmonic Current Limits (%)
1st	11.980	--	Single phase	--
2nd	0.007	0.060	Single phase	8
3rd	0.343	2.860	Single phase	21,6
4th	0.023	0.188	Single phase	4
5th	0.265	2.208	Single phase	10,7
6th	0.012	0.102	Single phase	2,7
7th	0.175	1.461	Single phase	7,2
8th	0.011	0.095	Single phase	2
9th	0.126	1.050	Single phase	3,8
10th	0.010	0.082	Single phase	1,6
11th	0.093	0.775	Single phase	3,1
12th	0.006	0.050	Single phase	1,3
13th	0.071	0.590	Single phase	2
14th	0.004	0.037	Single phase	N/A
15th	0.043	0.362	Single phase	N/A
16th	0.003	0.028	Single phase	N/A
17th	0.038	0.313	Single phase	N/A
18th	0.007	0.059	Single phase	N/A
19th	0.029	0.243	Single phase	N/A
20th	0.004	0.036	Single phase	N/A
21st	0.016	0.133	Single phase	N/A
22nd	0.008	0.066	Single phase	N/A
23rd	0.014	0.118	Single phase	N/A
24th	0.006	0.047	Single phase	N/A
25th	0.014	0.117	Single phase	N/A
26th	0.004	0.031	Single phase	N/A
27th	0.009	0.072	Single phase	N/A
28th	0.008	0.065	Single phase	N/A
29th	0.009	0.073	Single phase	N/A
30th	0.003	0.027	Single phase	N/A
31st	0.006	0.050	Single phase	N/A
32nd	0.006	0.051	Single phase	N/A
33rd	0.005	0.043	Single phase	N/A
34th	0.004	0.029	Single phase	N/A
35th	0.006	0.046	Single phase	N/A
36th	0.005	0.040	Single phase	N/A
37th	0.004	0.031	Single phase	N/A
38th	0.003	0.028	Single phase	N/A
39th	0.005	0.043	Single phase	N/A
40th	0.002	0.017	Single phase	N/A
THD	--	4.255	Single phase	23
PWHD	--	2.656	Single phase	23

CEI 0-21			
Clause	Requirement - Test	Result - Remark	Verdict

Bbis.3	TABLE: Harmonics measurement under test condition 25°C /-25°C / 60°C, 100%/ 66%/ 33% P_SMAX and P_CMAX (CEI EN 61000-3-12)			P
Model	VT-6607106+16Battery			
Active power (W)	2730.75 (-25°C)			
Voltage (V)	229.58			
Current (A)	11.99			
Power Factor	0.992			
Frequency (Hz)	50.00			
Harmonics	Current Magnitude (A)	Current Percent of Fundamental (%)	Phase	Harmonic Current Limits (%)
1st	11.981	--	Single phase	--
2nd	0.008	0.064	Single phase	8
3rd	0.342	2.855	Single phase	21,6
4th	0.023	0.193	Single phase	4
5th	0.265	2.209	Single phase	10,7
6th	0.012	0.098	Single phase	2,7
7th	0.175	1.460	Single phase	7,2
8th	0.011	0.092	Single phase	2
9th	0.126	1.049	Single phase	3,8
10th	0.010	0.080	Single phase	1,6
11th	0.093	0.773	Single phase	3,1
12th	0.006	0.050	Single phase	1,3
13th	0.070	0.587	Single phase	2
14th	0.004	0.037	Single phase	N/A
15th	0.043	0.361	Single phase	N/A
16th	0.003	0.028	Single phase	N/A
17th	0.037	0.312	Single phase	N/A
18th	0.007	0.059	Single phase	N/A
19th	0.029	0.244	Single phase	N/A
20th	0.005	0.039	Single phase	N/A
21st	0.016	0.136	Single phase	N/A
22nd	0.008	0.064	Single phase	N/A
23rd	0.015	0.123	Single phase	N/A
24th	0.006	0.048	Single phase	N/A
25th	0.014	0.118	Single phase	N/A
26th	0.004	0.030	Single phase	N/A
27th	0.009	0.073	Single phase	N/A
28th	0.008	0.066	Single phase	N/A
29th	0.008	0.070	Single phase	N/A
30th	0.003	0.029	Single phase	N/A
31st	0.006	0.050	Single phase	N/A
32nd	0.006	0.047	Single phase	N/A
33rd	0.005	0.040	Single phase	N/A
34th	0.004	0.030	Single phase	N/A
35th	0.005	0.043	Single phase	N/A
36th	0.002	0.020	Single phase	N/A
37th	0.003	0.029	Single phase	N/A
38th	0.003	0.026	Single phase	N/A
39th	0.005	0.043	Single phase	N/A
40th	0.002	0.016	Single phase	N/A
THD	--	4.241	Single phase	23
PWHD	--	2.649	Single phase	23

CEI 0-21			
Clause	Requirement - Test	Result - Remark	Verdict

Bbis.3	TABLE: Harmonics measurement under test condition 25°C /-25°C / 60°C, 100%/ 66%/ 33% P_SMAX and P_CMAX (CEI EN 61000-3-12)			P
Model	VT-6607106+16Battery			
Active power (W)	2730.77 (25°C)			
Voltage (V)	229.59			
Current (A)	11.99			
Power Factor	0.992			
Frequency (Hz)	50.00			
Harmonics	Current Magnitude (A)	Current Percent of Fundamental (%)	Phase	Harmonic Current Limits (%)
1st	11.980	--	Single phase	--
2nd	0.008	0.068	Single phase	8
3rd	0.342	2.852	Single phase	21,6
4th	0.023	0.191	Single phase	4
5th	0.265	2.209	Single phase	10,7
6th	0.012	0.099	Single phase	2,7
7th	0.175	1.461	Single phase	7,2
8th	0.011	0.095	Single phase	2
9th	0.126	1.048	Single phase	3,8
10th	0.010	0.081	Single phase	1,6
11th	0.093	0.775	Single phase	3,1
12th	0.006	0.052	Single phase	1,3
13th	0.071	0.588	Single phase	2
14th	0.005	0.038	Single phase	N/A
15th	0.043	0.362	Single phase	N/A
16th	0.003	0.027	Single phase	N/A
17th	0.037	0.313	Single phase	N/A
18th	0.007	0.059	Single phase	N/A
19th	0.029	0.244	Single phase	N/A
20th	0.004	0.037	Single phase	N/A
21st	0.016	0.133	Single phase	N/A
22nd	0.008	0.065	Single phase	N/A
23rd	0.014	0.120	Single phase	N/A
24th	0.006	0.048	Single phase	N/A
25th	0.014	0.115	Single phase	N/A
26th	0.004	0.031	Single phase	N/A
27th	0.009	0.073	Single phase	N/A
28th	0.008	0.065	Single phase	N/A
29th	0.009	0.072	Single phase	N/A
30th	0.003	0.029	Single phase	N/A
31st	0.006	0.047	Single phase	N/A
32nd	0.005	0.045	Single phase	N/A
33rd	0.005	0.043	Single phase	N/A
34th	0.004	0.030	Single phase	N/A
35th	0.005	0.045	Single phase	N/A
36th	0.004	0.033	Single phase	N/A
37th	0.004	0.032	Single phase	N/A
38th	0.003	0.028	Single phase	N/A
39th	0.005	0.043	Single phase	N/A
40th	0.002	0.016	Single phase	N/A
THD	--	4.247	Single phase	23
PWHD	--	2.651	Single phase	23

CEI 0-21			
Clause	Requirement - Test	Result - Remark	Verdict

Bbis.3	TABLE: Harmonics measurement under test condition 25°C /- 25°C / 60°C, 100% / 66% / 33% P _S MAX and P _C MAX (CEI EN 61000-3-12)			P
Model	VT-6607106+16Battery			
Active power (W)	1360.72 (60°C)			
Voltage (V)	229.46			
Current (A)	6.08			
Power Factor	0.975			
Frequency (Hz)	50.00			
Harmonics	Current Magnitude (A)	Current Percent of Fundamental (%)	Phase	Harmonic Current Limits (%)
1st	6.065	--	Single phase	--
2nd	0.007	0.119	Single phase	8
3rd	0.336	5.535	Single phase	21,6
4th	0.013	0.216	Single phase	4
5th	0.205	3.377	Single phase	10,7
6th	0.010	0.166	Single phase	2,7
7th	0.107	1.767	Single phase	7,2
8th	0.015	0.245	Single phase	2
9th	0.061	0.998	Single phase	3,8
10th	0.013	0.219	Single phase	1,6
11th	0.029	0.478	Single phase	3,1
12th	0.012	0.197	Single phase	1,3
13th	0.006	0.107	Single phase	2
14th	0.011	0.176	Single phase	N/A
15th	0.008	0.126	Single phase	N/A
16th	0.008	0.133	Single phase	N/A
17th	0.007	0.115	Single phase	N/A
18th	0.002	0.034	Single phase	N/A
19th	0.011	0.179	Single phase	N/A
20th	0.010	0.158	Single phase	N/A
21st	0.011	0.185	Single phase	N/A
22nd	0.010	0.170	Single phase	N/A
23rd	0.009	0.151	Single phase	N/A
24th	0.007	0.116	Single phase	N/A
25th	0.011	0.178	Single phase	N/A
26th	0.002	0.039	Single phase	N/A
27th	0.009	0.151	Single phase	N/A
28th	0.005	0.089	Single phase	N/A
29th	0.005	0.083	Single phase	N/A
30th	0.003	0.052	Single phase	N/A
31st	0.003	0.055	Single phase	N/A
32nd	0.002	0.030	Single phase	N/A
33rd	0.002	0.037	Single phase	N/A
34th	0.003	0.050	Single phase	N/A
35th	0.003	0.052	Single phase	N/A
36th	0.005	0.076	Single phase	N/A
37th	0.002	0.035	Single phase	N/A
38th	0.003	0.046	Single phase	N/A
39th	0.003	0.051	Single phase	N/A
40th	0.002	0.027	Single phase	N/A
THD	--	6.932	Single phase	23
PWHD	--	2.705	Single phase	23

CEI 0-21			
Clause	Requirement - Test	Result - Remark	Verdict

Bbis.3	TABLE: Harmonics measurement under test condition 25°C /-25°C / 60°C, 100%/ 66%/ 33% P_SMAX and P_CMAX (CEI EN 61000-3-12)			P
Model	VT-6607106+16Battery			
Active power (W)	1360.66 (-25°C)			
Voltage (V)	229.46			
Current (A)	6.08			
Power Factor	0.975			
Frequency (Hz)	50.00			
Harmonics	Current Magnitude (A)	Current Percent of Fundamental (%)	Phase	Harmonic Current Limits (%)
1st	6.065	--	Single phase	--
2nd	0.007	0.120	Single phase	8
3rd	0.337	5.543	Single phase	21,6
4th	0.013	0.210	Single phase	4
5th	0.205	3.373	Single phase	10,7
6th	0.010	0.165	Single phase	2,7
7th	0.108	1.773	Single phase	7,2
8th	0.015	0.249	Single phase	2
9th	0.060	0.994	Single phase	3,8
10th	0.013	0.219	Single phase	1,6
11th	0.029	0.484	Single phase	3,1
12th	0.012	0.193	Single phase	1,3
13th	0.006	0.106	Single phase	2
14th	0.011	0.177	Single phase	N/A
15th	0.008	0.124	Single phase	N/A
16th	0.008	0.132	Single phase	N/A
17th	0.007	0.118	Single phase	N/A
18th	0.002	0.030	Single phase	N/A
19th	0.011	0.177	Single phase	N/A
20th	0.010	0.157	Single phase	N/A
21st	0.011	0.188	Single phase	N/A
22nd	0.010	0.161	Single phase	N/A
23rd	0.010	0.161	Single phase	N/A
24th	0.007	0.111	Single phase	N/A
25th	0.011	0.182	Single phase	N/A
26th	0.002	0.039	Single phase	N/A
27th	0.009	0.155	Single phase	N/A
28th	0.005	0.088	Single phase	N/A
29th	0.005	0.083	Single phase	N/A
30th	0.003	0.045	Single phase	N/A
31st	0.003	0.053	Single phase	N/A
32nd	0.002	0.037	Single phase	N/A
33rd	0.002	0.035	Single phase	N/A
34th	0.003	0.050	Single phase	N/A
35th	0.003	0.050	Single phase	N/A
36th	0.005	0.084	Single phase	N/A
37th	0.002	0.037	Single phase	N/A
38th	0.003	0.047	Single phase	N/A
39th	0.003	0.053	Single phase	N/A
40th	0.002	0.028	Single phase	N/A
THD	--	6.967	Single phase	23
PWHD	--	2.721	Single phase	23

CEI 0-21			
Clause	Requirement - Test	Result - Remark	Verdict

Bbis.3	TABLE: Harmonics measurement under test condition 25°C /-25°C / 60°C, 100%/ 66%/ 33% P_SMAX and P_CMAX (CEI EN 61000-3-12)			P
Model	VT-6607106+16Battery			
Active power (W)	1351.70 (25°C)			
Voltage (V)	229.91			
Current (A)	5.99			
Power Factor	0.982			
Frequency (Hz)	50.00			
Harmonics	Current Magnitude (A)	Current Percent of Fundamental (%)	Phase	Harmonic Current Limits (%)
1st	5.966	--	Single phase	--
2nd	0.056	0.931	Single phase	8
3rd	0.080	1.339	Single phase	21,6
4th	0.010	0.169	Single phase	4
5th	0.378	6.313	Single phase	10,7
6th	0.006	0.105	Single phase	2,7
7th	0.272	4.540	Single phase	7,2
8th	0.007	0.121	Single phase	2
9th	0.076	1.270	Single phase	3,8
10th	0.013	0.223	Single phase	1,6
11th	0.160	2.676	Single phase	3,1
12th	0.008	0.128	Single phase	1,3
13th	0.099	1.648	Single phase	2
14th	0.007	0.123	Single phase	N/A
15th	0.021	0.349	Single phase	N/A
16th	0.008	0.130	Single phase	N/A
17th	0.055	0.912	Single phase	N/A
18th	0.006	0.096	Single phase	N/A
19th	0.041	0.688	Single phase	N/A
20th	0.004	0.073	Single phase	N/A
21st	0.023	0.381	Single phase	N/A
22nd	0.005	0.090	Single phase	N/A
23rd	0.030	0.493	Single phase	N/A
24th	0.005	0.085	Single phase	N/A
25th	0.021	0.346	Single phase	N/A
26th	0.007	0.119	Single phase	N/A
27th	0.017	0.283	Single phase	N/A
28th	0.005	0.083	Single phase	N/A
29th	0.024	0.403	Single phase	N/A
30th	0.003	0.052	Single phase	N/A
31st	0.019	0.314	Single phase	N/A
32nd	0.005	0.083	Single phase	N/A
33rd	0.016	0.268	Single phase	N/A
34th	0.004	0.067	Single phase	N/A
35th	0.019	0.324	Single phase	N/A
36th	0.004	0.059	Single phase	N/A
37th	0.018	0.305	Single phase	N/A
38th	0.003	0.050	Single phase	N/A
39th	0.009	0.150	Single phase	N/A
40th	0.003	0.053	Single phase	N/A
THD	--	8.980	Single phase	23
PWHD	--	7.733	Single phase	23

CEI 0-21			
Clause	Requirement - Test	Result - Remark	Verdict

Bbis.3	TABLE: Harmonics measurement under test condition 25°C /-25°C / 60°C, 100%/ 66%/ 33% P _S MAX and P _C MAX (CEI EN 61000-3-12)			P
Model	VT-6607106+1Battery			
Active power (W)	-1360.61 (-25°C)			
Voltage (V)	229.47			
Current (A)	6.08			
Power Factor	-0.975			
Frequency (Hz)	50.00			
Harmonics	Current Magnitude (A)	Current Percent of Fundamental (%)	Phase	Harmonic Current Limits (%)
1st	6.065	--	Single phase	--
2nd	0.007	0.123	Single phase	8
3rd	0.337	5.550	Single phase	21,6
4th	0.013	0.211	Single phase	4
5th	0.205	3.378	Single phase	10,7
6th	0.010	0.167	Single phase	2,7
7th	0.108	1.773	Single phase	7,2
8th	0.015	0.248	Single phase	2
9th	0.060	0.992	Single phase	3,8
10th	0.013	0.217	Single phase	1,6
11th	0.029	0.477	Single phase	3,1
12th	0.012	0.190	Single phase	1,3
13th	0.006	0.103	Single phase	2
14th	0.011	0.180	Single phase	N/A
15th	0.008	0.125	Single phase	N/A
16th	0.008	0.131	Single phase	N/A
17th	0.007	0.117	Single phase	N/A
18th	0.002	0.031	Single phase	N/A
19th	0.011	0.182	Single phase	N/A
20th	0.009	0.156	Single phase	N/A
21st	0.011	0.184	Single phase	N/A
22nd	0.009	0.149	Single phase	N/A
23rd	0.009	0.154	Single phase	N/A
24th	0.007	0.115	Single phase	N/A
25th	0.011	0.182	Single phase	N/A
26th	0.002	0.039	Single phase	N/A
27th	0.009	0.154	Single phase	N/A
28th	0.006	0.094	Single phase	N/A
29th	0.006	0.092	Single phase	N/A
30th	0.003	0.045	Single phase	N/A
31st	0.003	0.051	Single phase	N/A
32nd	0.002	0.037	Single phase	N/A
33rd	0.002	0.038	Single phase	N/A
34th	0.003	0.053	Single phase	N/A
35th	0.003	0.051	Single phase	N/A
36th	0.005	0.075	Single phase	N/A
37th	0.002	0.036	Single phase	N/A
38th	0.003	0.042	Single phase	N/A
39th	0.004	0.058	Single phase	N/A
40th	0.002	0.029	Single phase	N/A
THD	--	6.966	Single phase	23
PWHD	--	2.707	Single phase	23

CEI 0-21			
Clause	Requirement - Test	Result - Remark	Verdict

Bbis.3	TABLE: Harmonics measurement under test condition 25°C /-25°C / 60°C, 100%/ 66%/ 33% P_SMAX and P_CMAX (CEI EN 61000-3-12)			P
Model	VT-6607106+1Battery			
Active power (W)	-2730.86 (-25°C)			
Voltage (V)	229.59			
Current (A)	11.99			
Power Factor	-0.992			
Frequency (Hz)	50.00			
Harmonics	Current Magnitude (A)	Current Percent of Fundamental (%)	Phase	Harmonic Current Limits (%)
1st	11.980	--	Single phase	--
2nd	0.008	0.070	Single phase	8
3rd	0.341	2.847	Single phase	21,6
4th	0.023	0.192	Single phase	4
5th	0.265	2.207	Single phase	10,7
6th	0.012	0.100	Single phase	2,7
7th	0.175	1.459	Single phase	7,2
8th	0.011	0.094	Single phase	2
9th	0.126	1.048	Single phase	3,8
10th	0.010	0.082	Single phase	1,6
11th	0.093	0.772	Single phase	3,1
12th	0.006	0.052	Single phase	1,3
13th	0.070	0.588	Single phase	2
14th	0.005	0.040	Single phase	N/A
15th	0.043	0.362	Single phase	N/A
16th	0.003	0.028	Single phase	N/A
17th	0.037	0.311	Single phase	N/A
18th	0.007	0.058	Single phase	N/A
19th	0.029	0.244	Single phase	N/A
20th	0.005	0.039	Single phase	N/A
21st	0.016	0.133	Single phase	N/A
22nd	0.008	0.067	Single phase	N/A
23rd	0.015	0.121	Single phase	N/A
24th	0.006	0.046	Single phase	N/A
25th	0.014	0.117	Single phase	N/A
26th	0.004	0.031	Single phase	N/A
27th	0.009	0.073	Single phase	N/A
28th	0.008	0.063	Single phase	N/A
29th	0.009	0.072	Single phase	N/A
30th	0.003	0.028	Single phase	N/A
31st	0.006	0.047	Single phase	N/A
32nd	0.006	0.047	Single phase	N/A
33rd	0.005	0.043	Single phase	N/A
34th	0.004	0.030	Single phase	N/A
35th	0.005	0.044	Single phase	N/A
36th	0.004	0.032	Single phase	N/A
37th	0.004	0.031	Single phase	N/A
38th	0.003	0.029	Single phase	N/A
39th	0.005	0.044	Single phase	N/A
40th	0.002	0.014	Single phase	N/A
THD	--	4.250	Single phase	23
PWHD	--	2.650	Single phase	23

CEI 0-21			
Clause	Requirement - Test	Result - Remark	Verdict

Bbis.3	TABLE: Harmonics measurement under test condition 25°C /-25°C / 60°C, 100%/ 66%/ 33% P_SMAX and P_CMAX (CEI EN 61000-3-12)			P
Model	VT-6607106+1Battery			
Active power (W)	-4091.29 (-25°C)			
Voltage (V)	229.67			
Current (A)	17.91			
Power Factor	0.995			
Frequency (Hz)	50.00			
Harmonics	Current Magnitude (A)	Current Percent of Fundamental (%)	Phase	Harmonic Current Limits (%)
1st	17.898	--	Single phase	--
2nd	0.024	0.135	Single phase	8
3rd	0.387	2.162	Single phase	21,6
4th	0.036	0.202	Single phase	4
5th	0.292	1.630	Single phase	10,7
6th	0.005	0.029	Single phase	2,7
7th	0.203	1.132	Single phase	7,2
8th	0.013	0.072	Single phase	2
9th	0.150	0.840	Single phase	3,8
10th	0.022	0.125	Single phase	1,6
11th	0.114	0.638	Single phase	3,1
12th	0.028	0.156	Single phase	1,3
13th	0.073	0.408	Single phase	2
14th	0.025	0.139	Single phase	N/A
15th	0.061	0.341	Single phase	N/A
16th	0.018	0.099	Single phase	N/A
17th	0.055	0.306	Single phase	N/A
18th	0.017	0.094	Single phase	N/A
19th	0.043	0.238	Single phase	N/A
20th	0.004	0.025	Single phase	N/A
21st	0.023	0.128	Single phase	N/A
22nd	0.022	0.123	Single phase	N/A
23rd	0.019	0.106	Single phase	N/A
24th	0.008	0.046	Single phase	N/A
25th	0.020	0.114	Single phase	N/A
26th	0.003	0.019	Single phase	N/A
27th	0.018	0.103	Single phase	N/A
28th	0.002	0.013	Single phase	N/A
29th	0.011	0.062	Single phase	N/A
30th	0.008	0.043	Single phase	N/A
31st	0.011	0.060	Single phase	N/A
32nd	0.003	0.015	Single phase	N/A
33rd	0.011	0.062	Single phase	N/A
34th	0.006	0.032	Single phase	N/A
35th	0.008	0.042	Single phase	N/A
36th	0.008	0.047	Single phase	N/A
37th	0.007	0.042	Single phase	N/A
38th	0.005	0.028	Single phase	N/A
39th	0.007	0.038	Single phase	N/A
40th	0.004	0.024	Single phase	N/A
THD	--	3.264	Single phase	23
PWHD	--	2.716	Single phase	23

CEI 0-21			
Clause	Requirement - Test	Result - Remark	Verdict

Bbis.3	TABLE: Harmonics measurement under test condition 25°C /-25°C / 60°C, 100%/ 66%/ 33% P_SMAX and P_CMAX (CEI EN 61000-3-12)			P
Model	VT-6607106+1Battery			
Active power (W)	1360.65 (-25°C)			
Voltage (V)	229.46			
Current (A)	6.08			
Power Factor	0.975			
Frequency (Hz)	50.00			
Harmonics	Current Magnitude (A)	Current Percent of Fundamental (%)	Phase	Harmonic Current Limits (%)
1st	6.065	--	Single phase	--
2nd	0.007	0.120	Single phase	8
3rd	0.337	5.550	Single phase	21,6
4th	0.013	0.214	Single phase	4
5th	0.205	3.376	Single phase	10,7
6th	0.010	0.166	Single phase	2,7
7th	0.108	1.772	Single phase	7,2
8th	0.015	0.243	Single phase	2
9th	0.060	0.993	Single phase	3,8
10th	0.013	0.219	Single phase	1,6
11th	0.029	0.483	Single phase	3,1
12th	0.012	0.190	Single phase	1,3
13th	0.006	0.105	Single phase	2
14th	0.011	0.177	Single phase	N/A
15th	0.008	0.126	Single phase	N/A
16th	0.008	0.130	Single phase	N/A
17th	0.007	0.120	Single phase	N/A
18th	0.002	0.028	Single phase	N/A
19th	0.011	0.178	Single phase	N/A
20th	0.010	0.157	Single phase	N/A
21st	0.012	0.191	Single phase	N/A
22nd	0.009	0.140	Single phase	N/A
23rd	0.010	0.157	Single phase	N/A
24th	0.007	0.107	Single phase	N/A
25th	0.011	0.181	Single phase	N/A
26th	0.002	0.036	Single phase	N/A
27th	0.009	0.156	Single phase	N/A
28th	0.006	0.094	Single phase	N/A
29th	0.005	0.082	Single phase	N/A
30th	0.002	0.038	Single phase	N/A
31st	0.003	0.052	Single phase	N/A
32nd	0.002	0.037	Single phase	N/A
33rd	0.002	0.036	Single phase	N/A
34th	0.003	0.049	Single phase	N/A
35th	0.003	0.051	Single phase	N/A
36th	0.003	0.052	Single phase	N/A
37th	0.002	0.035	Single phase	N/A
38th	0.002	0.039	Single phase	N/A
39th	0.004	0.062	Single phase	N/A
40th	0.002	0.031	Single phase	N/A
THD	--	6.973	Single phase	23
PWHD	--	2.662	Single phase	23

CEI 0-21			
Clause	Requirement - Test	Result - Remark	Verdict

Bbis.3	TABLE: Harmonics measurement under test condition 25°C /-25°C / 60°C, 100%/ 66%/ 33% P_{SMAX} and P_{CMAX} (CEI EN 61000-3-12)			P
Model	VT-6607106+1Battery			
Active power (W)	2730.80 (-25°C)			
Voltage (V)	229.56			
Current (A)	11.99			
Power Factor	0.992			
Frequency (Hz)	50.00			
Harmonics	Current Magnitude (A)	Current Percent of Fundamental (%)	Phase	Harmonic Current Limits (%)
1st	11.982	--	Single phase	--
2nd	0.007	0.054	Single phase	8
3rd	0.342	2.852	Single phase	21,6
4th	0.022	0.181	Single phase	4
5th	0.264	2.203	Single phase	10,7
6th	0.013	0.104	Single phase	2,7
7th	0.175	1.459	Single phase	7,2
8th	0.011	0.093	Single phase	2
9th	0.126	1.048	Single phase	3,8
10th	0.011	0.092	Single phase	1,6
11th	0.093	0.773	Single phase	3,1
12th	0.006	0.047	Single phase	1,3
13th	0.070	0.587	Single phase	2
14th	0.004	0.037	Single phase	N/A
15th	0.043	0.361	Single phase	N/A
16th	0.004	0.029	Single phase	N/A
17th	0.037	0.310	Single phase	N/A
18th	0.007	0.059	Single phase	N/A
19th	0.029	0.245	Single phase	N/A
20th	0.005	0.039	Single phase	N/A
21st	0.016	0.136	Single phase	N/A
22nd	0.008	0.070	Single phase	N/A
23rd	0.015	0.125	Single phase	N/A
24th	0.006	0.052	Single phase	N/A
25th	0.014	0.119	Single phase	N/A
26th	0.004	0.031	Single phase	N/A
27th	0.009	0.074	Single phase	N/A
28th	0.007	0.062	Single phase	N/A
29th	0.008	0.070	Single phase	N/A
30th	0.004	0.036	Single phase	N/A
31st	0.006	0.046	Single phase	N/A
32nd	0.005	0.043	Single phase	N/A
33rd	0.005	0.044	Single phase	N/A
34th	0.004	0.030	Single phase	N/A
35th	0.005	0.043	Single phase	N/A
36th	0.007	0.057	Single phase	N/A
37th	0.004	0.030	Single phase	N/A
38th	0.003	0.027	Single phase	N/A
39th	0.005	0.043	Single phase	N/A
40th	0.002	0.014	Single phase	N/A
THD	--	4.238	Single phase	23
PWHD	--	2.673	Single phase	23

CEI 0-21			
Clause	Requirement - Test	Result - Remark	Verdict

Bbis.3	TABLE: Harmonics measurement under test condition 25°C /-25°C / 60°C, 100%/ 66%/ 33% P_SMAX and P_CMAX (CEI EN 61000-3-12)			P
Model	VT-6607106+1Battery			
Active power (W)	4091.29 (-25°C)			
Voltage (V)	229.67			
Current (A)	17.91			
Power Factor	0.995			
Frequency (Hz)	50.00			
Harmonics	Current Magnitude (A)	Current Percent of Fundamental (%)	Phase	Harmonic Current Limits (%)
1st	17.898	--	Single phase	--
2nd	0.024	0.135	Single phase	8
3rd	0.387	2.162	Single phase	21,6
4th	0.036	0.202	Single phase	4
5th	0.292	1.630	Single phase	10,7
6th	0.005	0.029	Single phase	2,7
7th	0.203	1.132	Single phase	7,2
8th	0.013	0.072	Single phase	2
9th	0.150	0.840	Single phase	3,8
10th	0.022	0.125	Single phase	1,6
11th	0.114	0.638	Single phase	3,1
12th	0.028	0.156	Single phase	1,3
13th	0.073	0.408	Single phase	2
14th	0.025	0.139	Single phase	N/A
15th	0.061	0.341	Single phase	N/A
16th	0.018	0.099	Single phase	N/A
17th	0.055	0.306	Single phase	N/A
18th	0.017	0.094	Single phase	N/A
19th	0.043	0.238	Single phase	N/A
20th	0.004	0.025	Single phase	N/A
21st	0.023	0.128	Single phase	N/A
22nd	0.022	0.123	Single phase	N/A
23rd	0.019	0.106	Single phase	N/A
24th	0.008	0.046	Single phase	N/A
25th	0.020	0.114	Single phase	N/A
26th	0.003	0.019	Single phase	N/A
27th	0.018	0.103	Single phase	N/A
28th	0.002	0.013	Single phase	N/A
29th	0.011	0.062	Single phase	N/A
30th	0.008	0.043	Single phase	N/A
31st	0.011	0.060	Single phase	N/A
32nd	0.003	0.015	Single phase	N/A
33rd	0.011	0.062	Single phase	N/A
34th	0.006	0.032	Single phase	N/A
35th	0.008	0.042	Single phase	N/A
36th	0.008	0.047	Single phase	N/A
37th	0.007	0.042	Single phase	N/A
38th	0.005	0.028	Single phase	N/A
39th	0.007	0.038	Single phase	N/A
40th	0.004	0.024	Single phase	N/A
THD	--	3.264	Single phase	23
PWHD	--	2.716	Single phase	23

CEI 0-21			
Clause	Requirement - Test	Result - Remark	Verdict

Bbis.3 a) Harmonics measurement under test condition 25°C /-25°C / 60°C (CEI EN 61000-3-2)				
60°C, 100% P_CMAX power condition: VT-6607100+1Battery				
Harmonic	L1 Phase (A)	L2 Phase (A)	L3 Phase (A)	Limit (A)
2nd	0.021	--	--	1.080
3rd	0.352	--	--	2.300
4th	0.008	--	--	0.430
5th	0.179	--	--	1.140
6th	0.011	--	--	0.300
7th	0.073	--	--	0.770
8th	0.015	--	--	0.230
9th	0.009	--	--	0.400
10th	0.012	--	--	0.184
11th	0.015	--	--	0.330
12th	0.013	--	--	0.153
13th	0.025	--	--	0.210
14th	0.008	--	--	0.131
15th	0.027	--	--	0.150
16th	0.005	--	--	0.115
17th	0.021	--	--	0.132
18th	0.004	--	--	0.102
19th	0.016	--	--	0.118
20th	0.006	--	--	0.092
21th	0.009	--	--	0.107
22th	0.007	--	--	0.084
23th	0.004	--	--	0.098
24th	0.003	--	--	0.077
25th	0.006	--	--	0.090
26th	0.003	--	--	0.071
27th	0.010	--	--	0.083
28th	0.005	--	--	0.066
29th	0.007	--	--	0.078
30th	0.003	--	--	0.061
31th	0.007	--	--	0.073
32th	0.002	--	--	0.058
33th	0.004	--	--	0.068
34th	0.003	--	--	0.054
35th	0.004	--	--	0.064
36th	0.005	--	--	0.051
37th	0.003	--	--	0.061
38th	0.002	--	--	0.048
39th	0.006	--	--	0.058
40th	0.002	--	--	0.046

CEI 0-21			
Clause	Requirement - Test	Result - Remark	Verdict

Harmonics measurement under test condition 25°C /-25°C / 60°C (CEI EN 61000-3-2)				
60°C, 66% P _{C_{MAX}} power condition: VT-6607100+1Battery				
Harmonic	L1 Phase (A)	L2 Phase (A)	L3 Phase (A)	Limit (A)
2nd	0.013	--	--	1.080
3rd	0.362	--	--	2.300
4th	0.011	--	--	0.430
5th	0.123	--	--	1.140
6th	0.021	--	--	0.300
7th	0.015	--	--	0.770
8th	0.019	--	--	0.230
9th	0.057	--	--	0.400
10th	0.009	--	--	0.184
11th	0.059	--	--	0.330
12th	0.006	--	--	0.153
13th	0.038	--	--	0.210
14th	0.007	--	--	0.131
15th	0.013	--	--	0.150
16th	0.005	--	--	0.115
17th	0.026	--	--	0.132
18th	0.003	--	--	0.102
19th	0.025	--	--	0.118
20th	0.009	--	--	0.092
21th	0.020	--	--	0.107
22th	0.003	--	--	0.084
23th	0.011	--	--	0.098
24th	0.003	--	--	0.077
25th	0.014	--	--	0.090
26th	0.003	--	--	0.071
27th	0.014	--	--	0.083
28th	0.003	--	--	0.066
29th	0.009	--	--	0.078
30th	0.003	--	--	0.061
31th	0.006	--	--	0.073
32th	0.002	--	--	0.058
33th	0.008	--	--	0.068
34th	0.003	--	--	0.054
35th	0.010	--	--	0.064
36th	0.007	--	--	0.051
37th	0.007	--	--	0.061
38th	0.002	--	--	0.048
39th	0.007	--	--	0.058
40th	0.002	--	--	0.046

CEI 0-21			
Clause	Requirement - Test	Result - Remark	Verdict

Harmonics measurement under test condition 25°C /-25°C / 60°C (CEI EN 61000-3-2)				
60°C, 33% P _{C_{MAX}} power condition: VT-6607100+1Battery				
Harmonic	L1 Phase (A)	L2 Phase (A)	L3 Phase (A)	Limit (A)
2nd	0.024	--	--	1.080
3rd	0.383	--	--	2.300
4th	0.012	--	--	0.430
5th	0.110	--	--	1.140
6th	0.015	--	--	0.300
7th	0.179	--	--	0.770
8th	0.008	--	--	0.230
9th	0.074	--	--	0.400
10th	0.013	--	--	0.184
11th	0.086	--	--	0.330
12th	0.010	--	--	0.153
13th	0.064	--	--	0.210
14th	0.014	--	--	0.131
15th	0.059	--	--	0.150
16th	0.007	--	--	0.115
17th	0.050	--	--	0.132
18th	0.005	--	--	0.102
19th	0.039	--	--	0.118
20th	0.007	--	--	0.092
21th	0.037	--	--	0.107
22th	0.003	--	--	0.084
23th	0.023	--	--	0.098
24th	0.004	--	--	0.077
25th	0.023	--	--	0.090
26th	0.004	--	--	0.071
27th	0.015	--	--	0.083
28th	0.005	--	--	0.066
29th	0.014	--	--	0.078
30th	0.003	--	--	0.061
31th	0.011	--	--	0.073
32th	0.003	--	--	0.058
33th	0.011	--	--	0.068
34th	0.003	--	--	0.054
35th	0.012	--	--	0.064
36th	0.006	--	--	0.051
37th	0.008	--	--	0.061
38th	0.002	--	--	0.048
39th	0.010	--	--	0.058
40th	0.002	--	--	0.046

CEI 0-21			
Clause	Requirement - Test	Result - Remark	Verdict

Harmonics measurement under test condition 25°C /-25°C / 60°C (CEI EN 61000-3-2)				
60°C, 100% P _S MAX power condition: VT-6607100+1Battery				
Harmonic	L1 Phase (A)	L2 Phase (A)	L3 Phase (A)	Limit (A)
2nd	0.018	--	--	1.080
3rd	0.352	--	--	2.300
4th	0.008	--	--	0.430
5th	0.179	--	--	1.140
6th	0.010	--	--	0.300
7th	0.073	--	--	0.770
8th	0.014	--	--	0.230
9th	0.009	--	--	0.400
10th	0.012	--	--	0.184
11th	0.015	--	--	0.330
12th	0.013	--	--	0.153
13th	0.025	--	--	0.210
14th	0.008	--	--	0.131
15th	0.027	--	--	0.150
16th	0.004	--	--	0.115
17th	0.021	--	--	0.132
18th	0.004	--	--	0.102
19th	0.016	--	--	0.118
20th	0.006	--	--	0.092
21th	0.010	--	--	0.107
22th	0.006	--	--	0.084
23th	0.004	--	--	0.098
24th	0.003	--	--	0.077
25th	0.006	--	--	0.090
26th	0.003	--	--	0.071
27th	0.010	--	--	0.083
28th	0.005	--	--	0.066
29th	0.006	--	--	0.078
30th	0.003	--	--	0.061
31th	0.007	--	--	0.073
32th	0.002	--	--	0.058
33th	0.004	--	--	0.068
34th	0.003	--	--	0.054
35th	0.004	--	--	0.064
36th	0.007	--	--	0.051
37th	0.004	--	--	0.061
38th	0.002	--	--	0.048
39th	0.006	--	--	0.058
40th	0.001	--	--	0.046

CEI 0-21			
Clause	Requirement - Test	Result - Remark	Verdict

Harmonics measurement under test condition 25°C /-25°C / 60°C (CEI EN 61000-3-2)				
60°C, 66% P_{SMAX} power condition: VT-6607100+1Battery				
Harmonic	L1 Phase (A)	L2 Phase (A)	L3 Phase (A)	Limit (A)
2nd	0.013	--	--	1.080
3rd	0.362	--	--	2.300
4th	0.010	--	--	0.430
5th	0.123	--	--	1.140
6th	0.020	--	--	0.300
7th	0.015	--	--	0.770
8th	0.019	--	--	0.230
9th	0.057	--	--	0.400
10th	0.009	--	--	0.184
11th	0.059	--	--	0.330
12th	0.006	--	--	0.153
13th	0.038	--	--	0.210
14th	0.007	--	--	0.131
15th	0.014	--	--	0.150
16th	0.005	--	--	0.115
17th	0.027	--	--	0.132
18th	0.003	--	--	0.102
19th	0.025	--	--	0.118
20th	0.009	--	--	0.092
21th	0.021	--	--	0.107
22th	0.003	--	--	0.084
23th	0.011	--	--	0.098
24th	0.003	--	--	0.077
25th	0.014	--	--	0.090
26th	0.003	--	--	0.071
27th	0.014	--	--	0.083
28th	0.003	--	--	0.066
29th	0.009	--	--	0.078
30th	0.003	--	--	0.061
31th	0.006	--	--	0.073
32th	0.002	--	--	0.058
33th	0.008	--	--	0.068
34th	0.003	--	--	0.054
35th	0.010	--	--	0.064
36th	0.005	--	--	0.051
37th	0.007	--	--	0.061
38th	0.002	--	--	0.048
39th	0.007	--	--	0.058
40th	0.002	--	--	0.046

CEI 0-21			
Clause	Requirement - Test	Result - Remark	Verdict

Harmonics measurement under test condition 25°C /-25°C / 60°C (CEI EN 61000-3-2)				
60°C, 33% P _{SMAX} power condition: VT-6607100+1Battery				
Harmonic	L1 Phase (A)	L2 Phase (A)	L3 Phase (A)	Limit (A)
2nd	0.024	--	--	1.080
3rd	0.383	--	--	2.300
4th	0.011	--	--	0.430
5th	0.111	--	--	1.140
6th	0.015	--	--	0.300
7th	0.180	--	--	0.770
8th	0.007	--	--	0.230
9th	0.075	--	--	0.400
10th	0.013	--	--	0.184
11th	0.087	--	--	0.330
12th	0.010	--	--	0.153
13th	0.064	--	--	0.210
14th	0.014	--	--	0.131
15th	0.060	--	--	0.150
16th	0.007	--	--	0.115
17th	0.050	--	--	0.132
18th	0.005	--	--	0.102
19th	0.039	--	--	0.118
20th	0.007	--	--	0.092
21th	0.037	--	--	0.107
22th	0.004	--	--	0.084
23th	0.024	--	--	0.098
24th	0.003	--	--	0.077
25th	0.023	--	--	0.090
26th	0.005	--	--	0.071
27th	0.015	--	--	0.083
28th	0.006	--	--	0.066
29th	0.014	--	--	0.078
30th	0.003	--	--	0.061
31th	0.011	--	--	0.073
32th	0.003	--	--	0.058
33th	0.012	--	--	0.068
34th	0.003	--	--	0.054
35th	0.012	--	--	0.064
36th	0.004	--	--	0.051
37th	0.008	--	--	0.061
38th	0.002	--	--	0.048
39th	0.010	--	--	0.058
40th	0.002	--	--	0.046

CEI 0-21			
Clause	Requirement - Test	Result - Remark	Verdict

Bbis.3 c)	TABLE: Flicker measurement	P
<input checked="" type="checkbox"/> CEI EN 61000-3-3 <input checked="" type="checkbox"/> CEI EN 61000-3-11		
<input checked="" type="checkbox"/> Ambient temperature <input checked="" type="checkbox"/> -20°C temperature <input checked="" type="checkbox"/> +60°C temperature		
<input checked="" type="checkbox"/> Full power, 66% and 33% of $P_{S_{MAX}} / P_{N_{INV}}$ <input checked="" type="checkbox"/> Full power, 66% and 33% of $P_{C_{MAX}}$		
c) limits of voltage fluctuations and flicker (CEI EN 61000-3-3 or CEI EN 61000-3-11); they must be repeated in 6 sessions (at 33%, 66% and 100% of the $P_{S_{MAX}}$, or $P_{N_{INV}}$ for integrated EESS, and at 33%, 66% and 100% of the $P_{C_{MAX}}$), and for storage systems connected to unidirectional converters in 3 sessions (at 33%, 66% and 100% of the maximum available power in discharge)		
Supplementary information: *If the EUT operating temperature out of -10°C to 55°C, please use the upper and lower operating temperature limit in the test.		

CEI 0-21			
Clause	Requirement - Test	Result - Remark	Verdict

Mode	VT-6607106+16Battery-Discharge				
Normal ambient					
Output power:	Flicker limits according to*:	Result:			
		Plt	Pst	dc%	
33%	EN61000-3-3 / EN61000-3-11	0.103	0.107	0.027	
66%	EN61000-3-3 / EN61000-3-11	0.104	0.107	0.041	
100%	EN61000-3-3 / EN61000-3-11	0.103	0.108	0.021	
Minimum ambient rating or -25°C					
Output power:	Flicker limits according to*:	Result:			
		Plt	Pst	dc%	
33%	EN61000-3-3 / EN61000-3-11	0.104	0.106	0.031	
66%	EN61000-3-3 / EN61000-3-11	0.104	0.106	0.041	
100%	EN61000-3-3 / EN61000-3-11	0.103	0.112	0.013	
Maximum ambient rating or 60°C					
Output power:	Flicker limits according to*:	Result:			
		Plt	Pst	dc%	
33%	EN61000-3-3 / EN61000-3-11	0.105	0.108	0.038	
66%	EN61000-3-3 / EN61000-3-11	0.104	0.108	0.041	
100%	EN61000-3-3 / EN61000-3-11	0.102	0.112	0.019	
Note:					
* Mains Impedance according EN61000-3-3 / EN61000-3-11: $R_{max} = \Omega$; $jX_{max} = \Omega @ 50\text{Hz}$ ($ Z_{max} = \Omega$)					
Calculation of the maximum permissible grid impedance at the point of common coupling based on dc:					
$Z_{max} = Z_{ref} * 3,3\% / dc(P_n)$					
The tests should be based on the limits of the EN61000-3-3 for less than 16A and on EN 61000-3-11 for more than 16A.					
	dc[%]	dmax[%]	d(t)[ms]	Pst	Plt
Limit	3.30	4.00	500 3.30%	1.00	0.65 N:12
No. 1	0.022 Pass	0.305 Pass	0.0 Pass	0.104 Pass	
2	0.026 Pass	0.287 Pass	0.0 Pass	0.103 Pass	
3	0.025 Pass	0.294 Pass	0.0 Pass	0.107 Pass	
4	0.023 Pass	0.293 Pass	0.0 Pass	0.103 Pass	
5	0.027 Pass	0.282 Pass	0.0 Pass	0.102 Pass	
6	0.023 Pass	0.298 Pass	0.0 Pass	0.103 Pass	
7	0.026 Pass	0.319 Pass	0.0 Pass	0.103 Pass	
8	0.026 Pass	0.312 Pass	0.0 Pass	0.102 Pass	
9	0.022 Pass	0.388 Pass	0.0 Pass	0.103 Pass	
10	0.027 Pass	0.303 Pass	0.0 Pass	0.102 Pass	
11	0.022 Pass	0.277 Pass	0.0 Pass	0.106 Pass	
12	0.026 Pass	0.276 Pass	0.0 Pass	0.103 Pass	
Result	Pass	Pass	Pass	Pass	0.103 Pass

CEI 0-21			
Clause	Requirement - Test	Result - Remark	Verdict

Mode	VT-6607106+16Battery-Charge			
Normal ambient				
Output power:	Flicker limits according to*:	Result:		
		Plt	Pst	dc%
33%	EN61000-3-3 / EN61000-3-11	0.109	0.111	0.056
66%	EN61000-3-3 / EN61000-3-11	0.109	0.111	0.046
100%	EN61000-3-3 / EN61000-3-11	0.105	0.108	0.038
Minimum ambient rating or -25°C				
Output power:	Flicker limits according to*:	Result:		
		Plt	Pst	dc%
33%	EN61000-3-3 / EN61000-3-11	0.110	0.116	0.049
66%	EN61000-3-3 / EN61000-3-11	0.110	0.117	0.054
100%	EN61000-3-3 / EN61000-3-11	0.104	0.109	0.035
Maximum ambient rating or 60°C				
Output power:	Flicker limits according to*:	Result:		
		Plt	Pst	dc%
33%	EN61000-3-3 / EN61000-3-11	0.111	0.117	0.053
66%	EN61000-3-3 / EN61000-3-11	0.110	0.113	0.052
100%	EN61000-3-3 / EN61000-3-11	0.105	0.108	0.039

Note:
* Mains Impedance according EN61000-3-3 / EN61000-3-11: $R_{max} = \Omega$; $jX_{max} = \Omega @50Hz$ ($|Z_{max}| = \Omega$)

Calculation of the maximum permissible grid impedance at the point of common coupling based on dc:
 $Z_{max} = Z_{ref} * 3,3\% / dc(P_n)$

	dc[%]	dmax[%]	d(t)[ms]	Pst	Plt
Limit	3.30	4.00	500 3.30%	1.00	0.65 N:12
No. 1	0.045 Pass	0.350 Pass	0.0 Pass	0.110 Pass	
2	0.047 Pass	0.329 Pass	0.0 Pass	0.107 Pass	
3	0.043 Pass	0.310 Pass	0.0 Pass	0.109 Pass	
4	0.041 Pass	0.357 Pass	0.0 Pass	0.108 Pass	
5	0.047 Pass	0.340 Pass	0.0 Pass	0.111 Pass	
6	0.041 Pass	0.317 Pass	0.0 Pass	0.109 Pass	
7	0.042 Pass	0.342 Pass	0.0 Pass	0.109 Pass	
8	0.044 Pass	0.354 Pass	0.0 Pass	0.109 Pass	
9	0.044 Pass	0.319 Pass	0.0 Pass	0.108 Pass	
10	0.051 Pass	0.292 Pass	0.0 Pass	0.106 Pass	
11	0.056 Pass	0.345 Pass	0.0 Pass	0.108 Pass	
12	0.052 Pass	0.439 Pass	0.0 Pass	0.111 Pass	
Result	Pass	Pass	Pass	Pass	0.109 Pass

CEI 0-21			
Clause	Requirement - Test	Result - Remark	Verdict

Mode		VT-6607106+1Battery-Discharge			
Abnormal ambient					
Output power:	Flicker limits according to*:	Result:			
		Plt	Pst	dc%	
33%	EN61000-3-3 / EN61000-3-11	0.096	0.103	0.023	
66%	EN61000-3-3 / EN61000-3-11	0.097	0.107	0.022	
100%	EN61000-3-3 / EN61000-3-11	0.096	0.102	0.020	
<p>Note:</p> <p>* Mains Impedance according EN61000-3-3 / EN61000-3-11: $R_{max} = \Omega$; $jX_{max} = \Omega @50Hz$ ($Z_{max} = \Omega$)</p> <p>Calculation of the maximum permissible grid impedance at the point of common coupling based on dc: $Z_{max} = Z_{ref} * 3,3\% / d_c(P_n)$</p> <p>The tests should be based on the limits of the EN61000-3-3 for less than 16A and on EN 61000-3-11 for more than 16A.</p> <p>If the EUT operating temperature out of -10°C to 55°C, please use the upper and lower operating temperature limit in the test (such as -25°C / +60°C).</p>					
	dc[%]	dmax[%]	d(t)[ms]	Pst	Plt
Limit	3.30	4.00	500 3.30%	1.00	0.65 N:12
No. 1	0.023 Pass	0.253 Pass	0.0 Pass	0.098 Pass	
2	0.021 Pass	0.279 Pass	0.0 Pass	0.096 Pass	
3	0.018 Pass	0.304 Pass	0.0 Pass	0.103 Pass	
4	0.015 Pass	0.300 Pass	0.0 Pass	0.093 Pass	
5	0.018 Pass	0.254 Pass	0.0 Pass	0.095 Pass	
6	0.015 Pass	0.275 Pass	0.0 Pass	0.095 Pass	
7	0.019 Pass	0.283 Pass	0.0 Pass	0.095 Pass	
8	0.017 Pass	0.279 Pass	0.0 Pass	0.093 Pass	
9	0.016 Pass	0.332 Pass	0.0 Pass	0.101 Pass	
10	0.016 Pass	0.302 Pass	0.0 Pass	0.098 Pass	
11	0.014 Pass	0.251 Pass	0.0 Pass	0.094 Pass	
12	0.015 Pass	0.331 Pass	0.0 Pass	0.094 Pass	
Result	Pass	Pass	Pass	Pass	0.096 Pass

CEI 0-21			
Clause	Requirement - Test	Result - Remark	Verdict

Mode		VT-6607106+1Battery-Charge			
Abnormal ambient					
Output power:	Flicker limits according to*:	Result:			
		Plt	Pst	dc%	
33%	EN61000-3-3 / EN61000-3-11	0.097	0.106	0.021	
66%	EN61000-3-3 / EN61000-3-11	0.099	0.106	0.023	
100%	EN61000-3-3 / EN61000-3-11	0.097	0.102	0.022	
<p>Note:</p> <p>* Mains Impedance according EN61000-3-3 / EN61000-3-11: $R_{max} = \Omega$; $jX_{max} = \Omega @50Hz$ ($Z_{max} = \Omega$)</p> <p>Calculation of the maximum permissible grid impedance at the point of common coupling based on dc: $Z_{max} = Z_{ref} * 3,3\% / d_c(P_n)$</p> <p>The tests should be based on the limits of the EN61000-3-3 for less than 16A and on EN 61000-3-11 for more than 16A. If the EUT operating temperature out of -10°C to 55°C, please use the upper and lower operating temperature limit in the test (such as -25°C / +60°C).</p>					
	dc[%]	dmax[%]	d(t)[ms]	Pst	Plt
Limit	3.30	4.00	500 3.30%	1.00	0.65 N:12
No. 1	0.018 Pass	0.285 Pass	0.0 Pass	0.092 Pass	
2	0.017 Pass	0.363 Pass	0.0 Pass	0.106 Pass	
3	0.017 Pass	0.290 Pass	0.0 Pass	0.093 Pass	
4	0.016 Pass	0.251 Pass	0.0 Pass	0.103 Pass	
5	0.021 Pass	0.315 Pass	0.0 Pass	0.094 Pass	
6	0.014 Pass	0.287 Pass	0.0 Pass	0.094 Pass	
7	0.015 Pass	0.364 Pass	0.0 Pass	0.099 Pass	
8	0.015 Pass	0.261 Pass	0.0 Pass	0.097 Pass	
9	0.018 Pass	0.300 Pass	0.0 Pass	0.097 Pass	
10	0.017 Pass	0.257 Pass	0.0 Pass	0.096 Pass	
11	0.015 Pass	0.364 Pass	0.0 Pass	0.096 Pass	
12	0.021 Pass	0.260 Pass	0.0 Pass	0.101 Pass	
Result	Pass	Pass	Pass	Pass	0.097 Pass

CEI 0-21			
Clause	Requirement - Test	Result - Remark	Verdict

Mode		VT-6607100+1Battery-Discharge			
Abnormal ambient					
Output power:	Flicker limits according to*:	Result:			
		Plt	Pst	dc%	
33%	EN61000-3-3 / EN61000-3-11	0.109	0.112	0.051	
66%	EN61000-3-3 / EN61000-3-11	0.110	0.112	0.047	
100%	EN61000-3-3 / EN61000-3-11	0.110	0.114	0.055	
<p>Note:</p> <p>* Mains Impedance according EN61000-3-3 / EN61000-3-11: $R_{max} = \Omega$; $jX_{max} = \Omega @50Hz$ ($Z_{max} = \Omega$)</p> <p>Calculation of the maximum permissible grid impedance at the point of common coupling based on dc: $Z_{max} = Z_{ref} * 3,3\% / d_c(P_n)$</p> <p>The tests should be based on the limits of the EN61000-3-3 for less than 16A and on EN 61000-3-11 for more than 16A.</p> <p>If the EUT operating temperature out of -10°C to 55°C, please use the upper and lower operating temperature limit in the test (such as -25°C / +60°C).</p>					
	dc[%]	dmax[%]	d(t)[ms]	Pst	Plt
Limit	3.30	4.00	500 3.30%	1.00	0.65 N:12
No. 1	0.051 Pass	0.338 Pass	0.0 Pass	0.110 Pass	
2	0.042 Pass	0.375 Pass	0.0 Pass	0.109 Pass	
3	0.039 Pass	0.282 Pass	0.0 Pass	0.110 Pass	
4	0.040 Pass	0.336 Pass	0.0 Pass	0.107 Pass	
5	0.043 Pass	0.320 Pass	0.0 Pass	0.112 Pass	
6	0.042 Pass	0.302 Pass	0.0 Pass	0.107 Pass	
7	0.045 Pass	0.300 Pass	0.0 Pass	0.108 Pass	
8	0.040 Pass	0.306 Pass	0.0 Pass	0.109 Pass	
9	0.042 Pass	0.344 Pass	0.0 Pass	0.111 Pass	
10	0.046 Pass	0.386 Pass	0.0 Pass	0.110 Pass	
11	0.044 Pass	0.348 Pass	0.0 Pass	0.110 Pass	
12	0.045 Pass	0.343 Pass	0.0 Pass	0.107 Pass	
Result	Pass	Pass	Pass	Pass	0.109 Pass

CEI 0-21			
Clause	Requirement - Test	Result - Remark	Verdict

Mode		VT-6607100+1Battery-Charge			
Abnormal ambient					
Output power:	Flicker limits according to*:	Result:			
		Plt	Pst	dc%	
33%	EN61000-3-3 / EN61000-3-11	0.097	0.105	0.022	
66%	EN61000-3-3 / EN61000-3-11	0.096	0.101	0.021	
100%	EN61000-3-3 / EN61000-3-11	0.096	0.100	0.020	
<p>Note:</p> <p>* Mains Impedance according EN61000-3-3 / EN61000-3-11: $R_{max} = \Omega$; $jX_{max} = \Omega @50Hz$ ($Z_{max} = \Omega$)</p> <p>Calculation of the maximum permissible grid impedance at the point of common coupling based on dc: $Z_{max} = Z_{ref} * 3,3\% / d_c(P_n)$</p> <p>The tests should be based on the limits of the EN61000-3-3 for less than 16A and on EN 61000-3-11 for more than 16A. If the EUT operating temperature out of -10°C to 55°C, please use the upper and lower operating temperature limit in the test (such as -25°C / +60°C).</p>					
	dc[%]	dmax[%]	d(t)[ms]	Pst	Plt
Limit	3.30	4.00	500 3.30%	1.00	0.65 N:12
No. 1	0.018 Pass	0.251 Pass	0.0 Pass	0.095 Pass	
2	0.020 Pass	0.297 Pass	0.0 Pass	0.096 Pass	
3	0.020 Pass	0.278 Pass	0.0 Pass	0.105 Pass	
4	0.022 Pass	0.335 Pass	0.0 Pass	0.093 Pass	
5	0.018 Pass	0.248 Pass	0.0 Pass	0.095 Pass	
6	0.017 Pass	0.295 Pass	0.0 Pass	0.096 Pass	
7	0.020 Pass	0.309 Pass	0.0 Pass	0.097 Pass	
8	0.016 Pass	0.272 Pass	0.0 Pass	0.099 Pass	
9	0.017 Pass	0.284 Pass	0.0 Pass	0.096 Pass	
10	0.017 Pass	0.304 Pass	0.0 Pass	0.094 Pass	
11	0.017 Pass	0.282 Pass	0.0 Pass	0.094 Pass	
12	0.018 Pass	0.302 Pass	0.0 Pass	0.099 Pass	
Result	Pass	Pass	Pass	Pass	0.097 Pass

CEI 0-21			
Clause	Requirement - Test	Result - Remark	Verdict

Bbis.4	TABLE: Check the operating range in voltage and frequency					P
Model	VT-6607106+16Battery					
Supplementary information:						
$P_{SMAX} = 4.096kW$						
$P_{CMAX} = 4.096kW$						
Test Point	Voltage (%)	Frequency(Hz)	P (W)	cos φ	Time (s)	Result
Test 1	84.99%	47.50	4094	0.998	>5min	No disconnection
Test 2	110.07%	51.50	4110	0.998	>5min	No disconnection
Test 3	84.98%	47.50	-4115	-0.997	>5min	No disconnection
Test 4	109.99%	51.50	-4098	-0.994	>5min	No disconnection
<p>Test 1: $V = 85 \% * V_n$; $f = 47,5 \text{ Hz}$; $P = 100 \% * P_{SMAX}$ (PNINV for integrated EESS); $\cos \varphi = 1$</p> <p>Test 2: $V = 110 \% * V_n$; $f = 51,5 \text{ Hz}$; $P = 100 \% * P_{SMAX}$ (PNINV for integrated EESS); $\cos \varphi = 1$</p> <p>Test 3: $V = 85 \% * V_n$; $f = 47,5 \text{ Hz}$; $P = 100 \% * P_{CMAX}$; $\cos \varphi = 1$</p> <p>Test 4: $V = 110 \% * V_n$; $f = 51,5 \text{ Hz}$; $P = 100 \% * P_{CMAX}$; $\cos \varphi = 1$</p> <p>During the tests it is necessary to disable the automatic regulation in reduction / increase of the power in case of over / under frequency.</p>						

CEI 0-21			
Clause	Requirement - Test	Result - Remark	Verdict

Diagram of Test 1

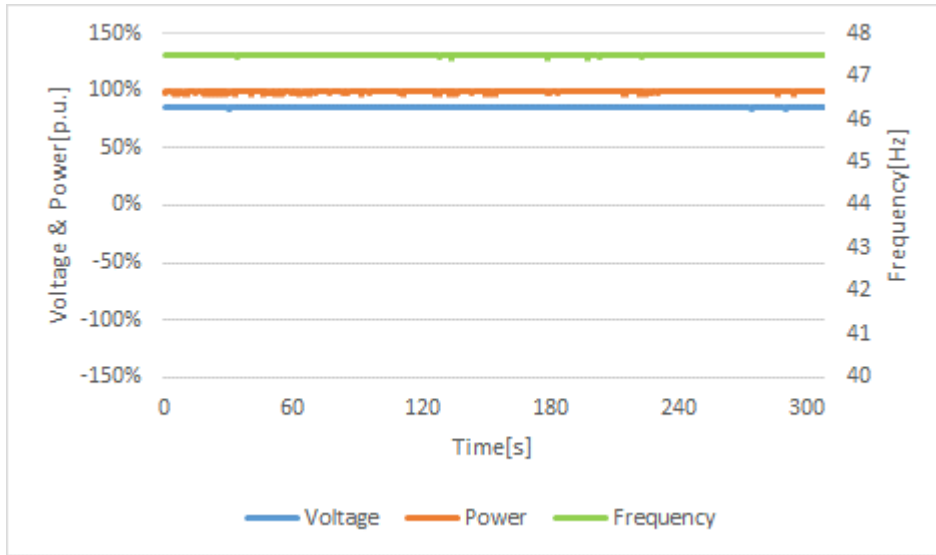
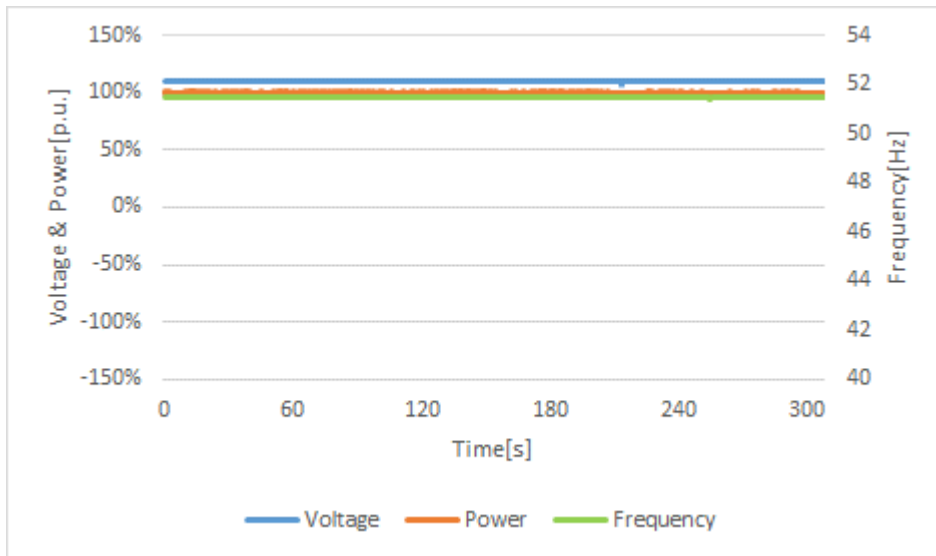

Diagram of Test 2



CEI 0-21			
Clause	Requirement - Test	Result - Remark	Verdict

Diagram of Test 3

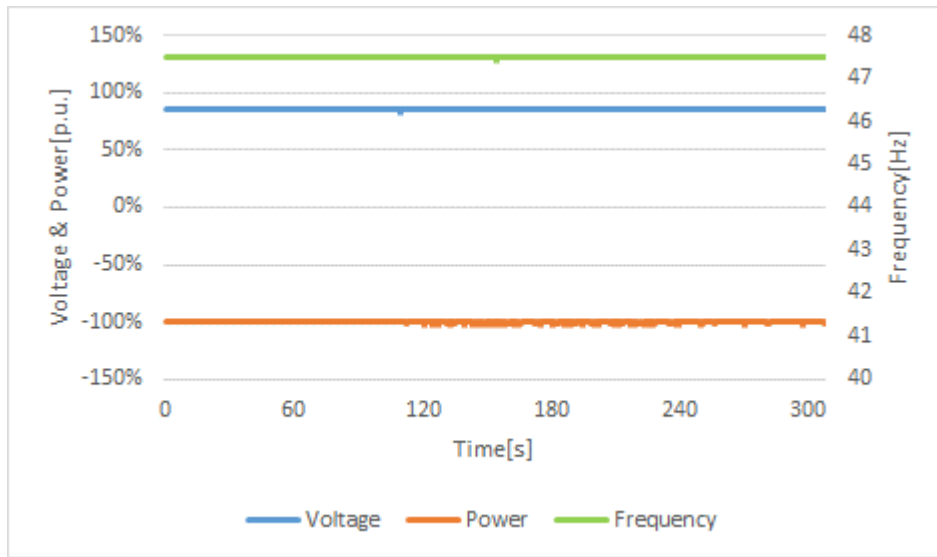
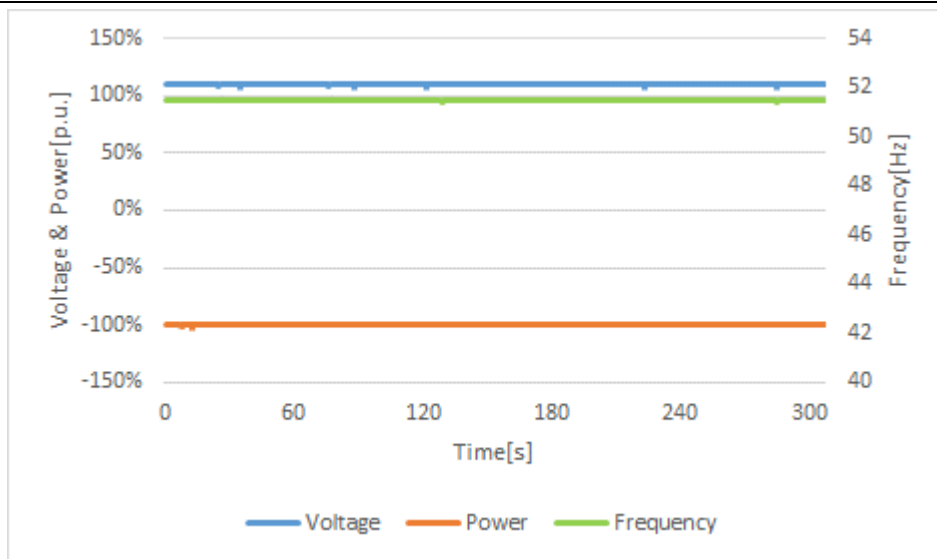

Diagram of Test 4



CEI 0-21			
Clause	Requirement - Test	Result - Remark	Verdict

Bbis.5	TABLE: Conditions of connection, reconnection and gradual power supply		P
Model	VT-6607106+16Battery		
Test:			
Power meter measurement-data:	Sample-Rate:	0.2 s	
	Sample time:		
Voltage conditons			
a) Out of voltage range	84% U_n for 30s	111% U_n for 30s	
Connection:	No connection	No connection	
Limit	No connection allowed		
b) In voltage range at start-up	85% $U_n < U < 110\% U_n$		
Reconnection time [s]	33.4	31.8	
Limit:	Reconnection after 30s		
Gradient:	Gradient should be recorded for at least 300s until the inverter has the full output power. Max gradient: 20%% P_{SMAX} or P_{NINV} / min For recorded gradient see diagram underneath		
c) In voltage range after voltage failure	85% $U_n < U < 110\% U_n$		
Reconnection time [s]	306.2	305.0	
Limit:	Reconnection after 300s		
Gradient:	Gradient should be recorded for at least 300s until the inverter has the full output power. Max gradient: 20%% P_{SMAX} or P_{NINV} / min For recorded gradient see diagram underneath		
Frequency conditions			
d) Out of frequency range	49,88 ± 0,01	50,12 ± 0,01	
Connection:	No connection	No connection	
Limit	No connection allowed		
e) In frequency range at start-up	49,90 Hz < f < 50,10		
Reconnection time [s]	34.8	31.4	
Limit:	Reconnection after 30s		
Gradient:	Gradient should be recorded for at least 300s until the inverter has the full output power. Max gradient: 20%% P_{SMAX} or P_{NINV} / min For recorded gradient see diagram underneath		
f) In frequency range after frequency failure	49,90 Hz < f < 50,10		
Reconnection time [s]	306.2	305.4	
Limit:	Reconnection after 300s		
Gradient:	Gradient should be recorded for at least 300s until the inverter has the full output power. Max gradient: 20%% P_{SMAX} or P_{NINV} / min For recorded gradient see diagram underneath		
Changable reconnection conditions:	Frequency range: 49Hz-51Hz in 0,05Hz steps (default value: 49,90 and 50,10Hz)		

CEI 0-21			
Clause	Requirement - Test	Result - Remark	Verdict

<p>Test: Test condition b) and c): voltage within the limits of 85% to 110%U_n Test condition e) and f): frequency within the limits of 49,90Hz to 50,10Hz Max deviation of the gradient: +2,5%P_SMAX OR P_NINV</p>		Reconnection time range: 0-900s in steps of 5s (default value: 300s)	
--	--	--	--

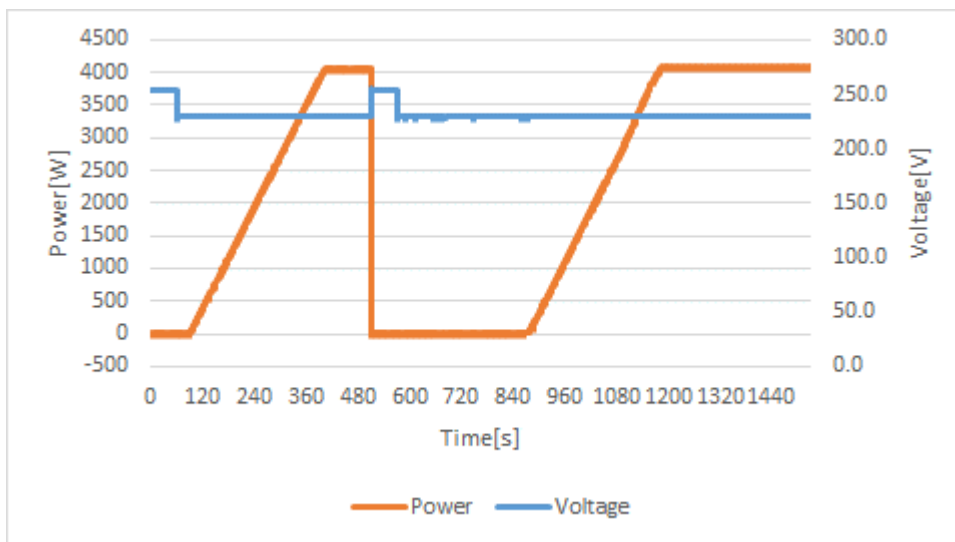
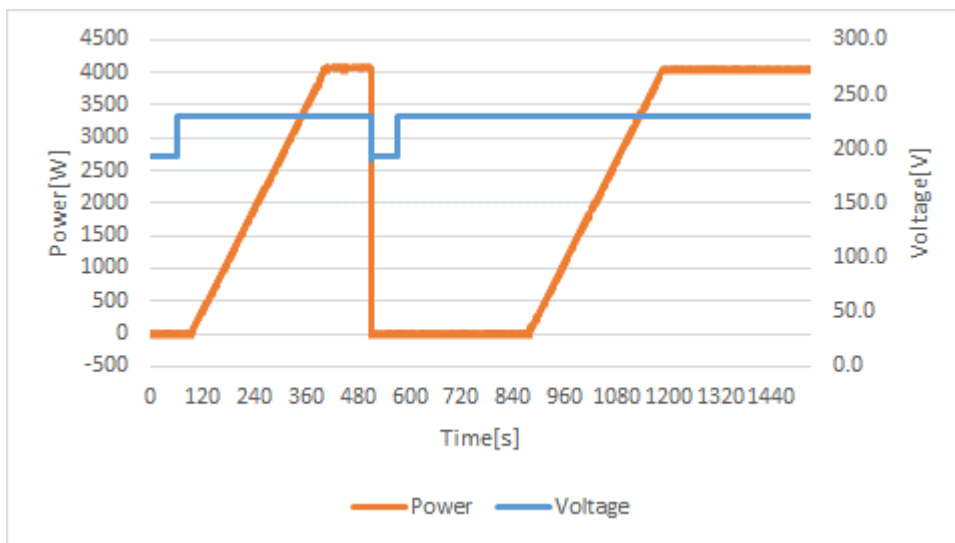

CEI 0-21			
Clause	Requirement - Test	Result - Remark	Verdict

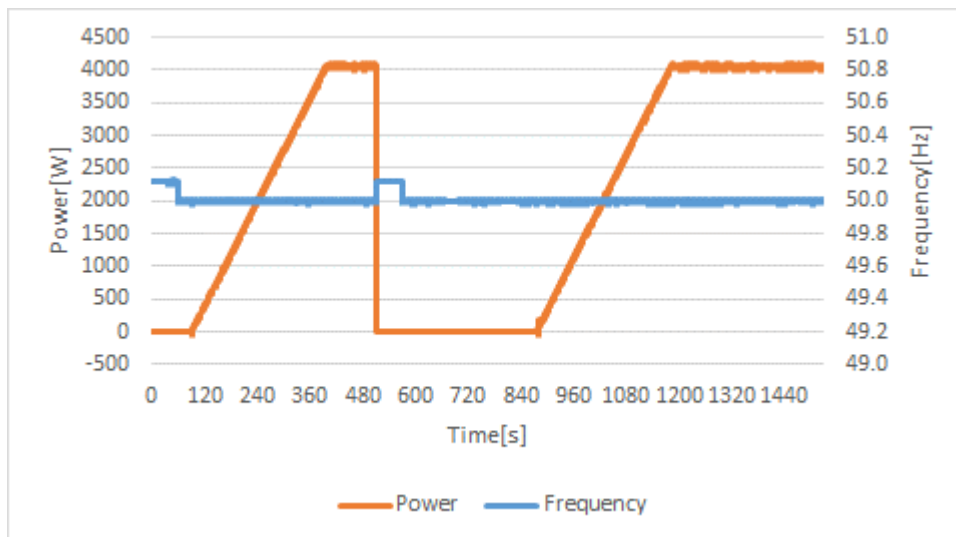
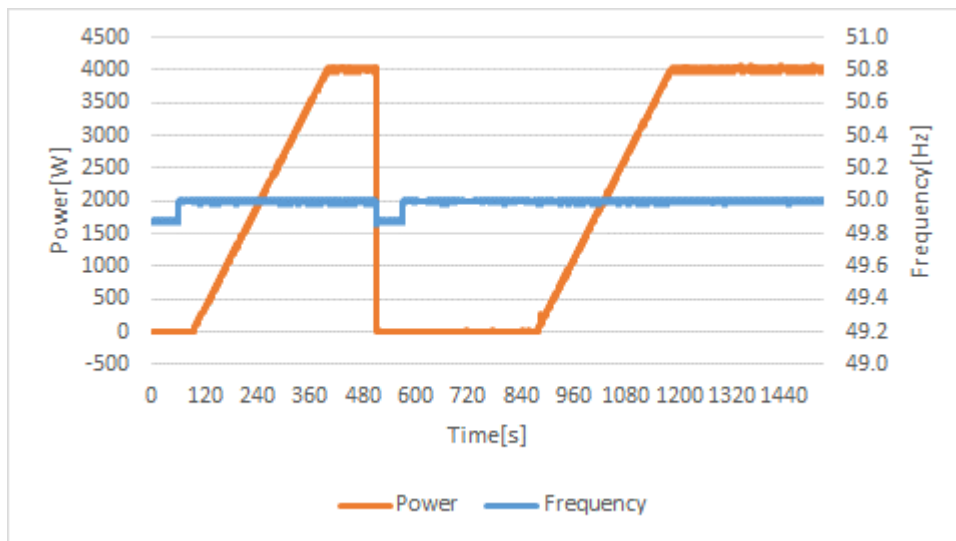

CEI 0-21			
Clause	Requirement - Test	Result - Remark	Verdict

Bbis.5	TABLE: Conditions of connection, reconnection and gradual power supply		P
Model	VT-6607106+1Battery		
Test:			
Power meter measurement-data:	Sample-Rate:	0.2 s	
	Sample time:	-	
Voltage conditons			
a) Out of voltage range	84% U_n for 30s	111% U_n for 30s	
Connection:	No connection	No connection	
Limit	No connection allowed		
b) In voltage range at start-up	85% $U_n < U < 110\% U_n$		
Reconnection time [s]	33.6	32.6	
Limit:	Reconnection after 30s		
Gradient:	Gradient should be recorded for at least 300s until the inverter has the full output power. Max gradient: 20%% P_{SMAX} or P_{NINV} / min For recorded gradient see diagram underneath		
c) In voltage range after voltage failure	85% $U_n < U < 110\% U_n$		
Reconnection time [s]	304.4	306.0	
Limit:	Reconnection after 300s		
Gradient:	Gradient should be recorded for at least 300s until the inverter has the full output power. Max gradient: 20%% P_{SMAX} or P_{NINV} / min For recorded gradient see diagram underneath		
Frequency conditions			
d) Out of frequency range	49,88 ± 0,01	50,12 ± 0,01	
Connection:	No connection	No connection	
Limit	No connection allowed		
e) In frequency range at start-up	49,90 Hz < f < 50,10		
Reconnection time [s]	35.6	33.4	
Limit:	Reconnection after 30s		
Gradient:	Gradient should be recorded for at least 300s until the inverter has the full output power. Max gradient: 20%% P_{SMAX} or P_{NINV} / min For recorded gradient see diagram underneath		
f) In frequency range after frequency failure	49,90 Hz < f < 50,10		
Reconnection time [s]	306.4	303.2	
Limit:	Reconnection after 300s		
Gradient:	Gradient should be recorded for at least 300s until the inverter has the full output power. Max gradient: 20%% P_{SMAX} or P_{NINV} / min For recorded gradient see diagram underneath		
Changable reconnection conditions:	Frequency range: 49Hz-51Hz in 0,05Hz steps (default value: 49,90 and 50,10Hz)		

CEI 0-21			
Clause	Requirement - Test	Result - Remark	Verdict

<p>Test: Test condition b) and c): voltage within the limits of 85% to 110%U_n Test condition e) and f): frequency within the limits of 49,90Hz to 50,10Hz Max deviation of the gradient: +2,5%P_SMAX OR P_NINV</p>		Reconnection time range: 0-900s in steps of 5s (default value: 300s)	
--	--	--	--

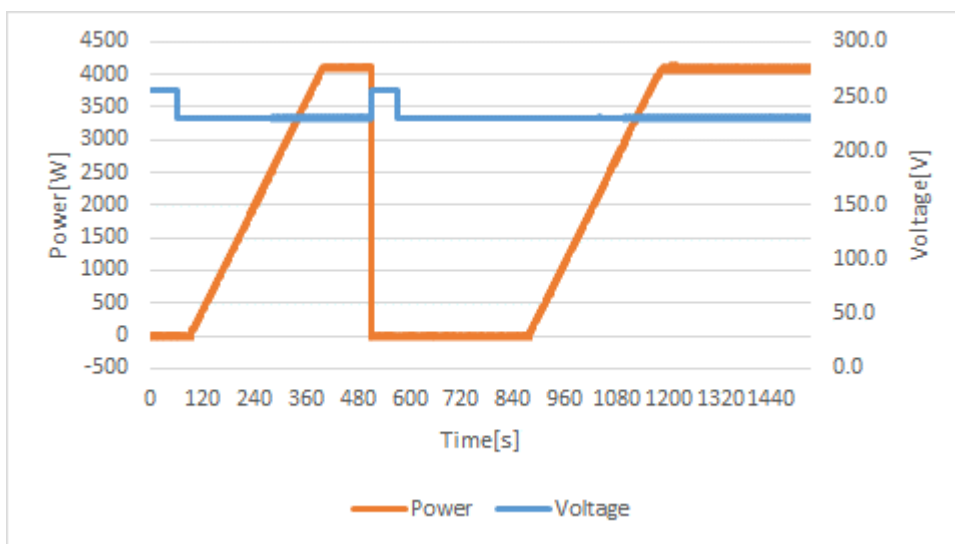
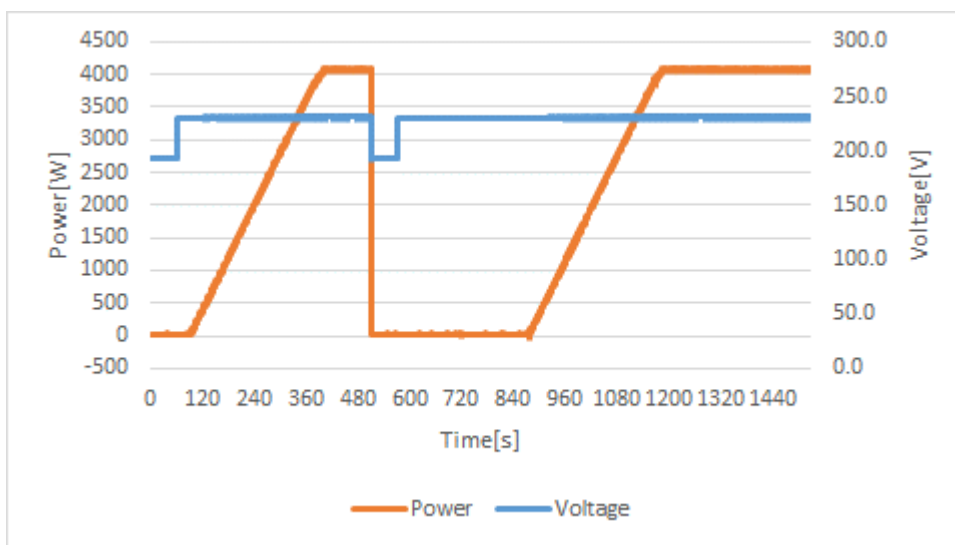

CEI 0-21			
Clause	Requirement - Test	Result - Remark	Verdict

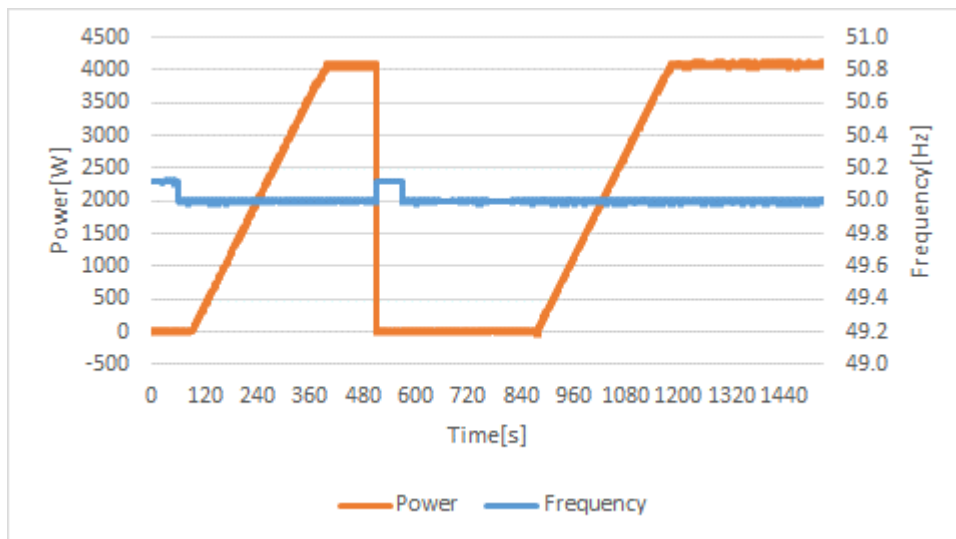
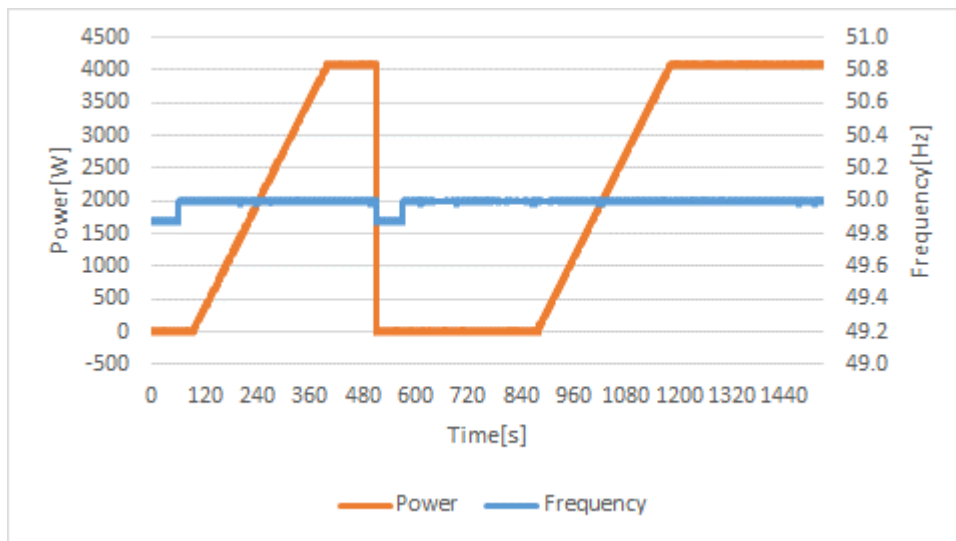

CEI 0-21			
Clause	Requirement - Test	Result - Remark	Verdict

Bbis.5	TABLE: Conditions of connection, reconnection and gradual power supply		P
Model	VT-6607100+1Battery		
Test:			
Power meter measurement-data:	Sample-Rate:	0.2 s	
	Sample time:	-	
Voltage conditons			
a) Out of voltage range	84% U_n for 30s	111% U_n for 30s	
Connection:	No connection	No connection	
Limit	No connection allowed		
b) In voltage range at start-up	85% $U_n < U < 110\% U_n$		
Reconnection time [s]	34.8	35.0	
Limit:	Reconnection after 30s		
Gradient:	Gradient should be recorded for at least 300s until the inverter has the full output power. Max gradient: 20%% P_{SMAX} or P_{NINV} / min For recorded gradient see diagram underneath		
c) In voltage range after voltage failure	85% $U_n < U < 110\% U_n$		
Reconnection time [s]	305.6	308.4	
Limit:	Reconnection after 300s		
Gradient:	Gradient should be recorded for at least 300s until the inverter has the full output power. Max gradient: 20%% P_{SMAX} or P_{NINV} / min For recorded gradient see diagram underneath		
Frequency conditions			
d) Out of frequency range	49,88 ± 0,01	50,12 ± 0,01	
Connection:	No connection	No connection	
Limit	No connection allowed		
e) In frequency range at start-up	49,90 Hz < f < 50,10		
Reconnection time [s]	34.2	34.0	
Limit:	Reconnection after 30s		
Gradient:	Gradient should be recorded for at least 300s until the inverter has the full output power. Max gradient: 20%% P_{SMAX} or P_{NINV} / min For recorded gradient see diagram underneath		
f) In frequency range after frequency failure	49,90 Hz < f < 50,10		
Reconnection time [s]	306.4	307.0	
Limit:	Reconnection after 300s		
Gradient:	Gradient should be recorded for at least 300s until the inverter has the full output power. Max gradient: 20%% P_{SMAX} or P_{NINV} / min For recorded gradient see diagram underneath		
Changable reconnection conditions:	Frequency range: 49Hz-51Hz in 0,05Hz steps (default value: 49,90 and 50,10Hz)		

CEI 0-21			
Clause	Requirement - Test	Result - Remark	Verdict

<p>Test: Test condition b) and c): voltage within the limits of 85% to 110%U_n Test condition e) and f): frequency within the limits of 49,90Hz to 50,10Hz Max deviation of the gradient: +2,5%P_{S MAX} OR P_{N INV}</p>		Reconnection time range: 0-900s in steps of 5s (default value: 300s)	
--	--	--	--

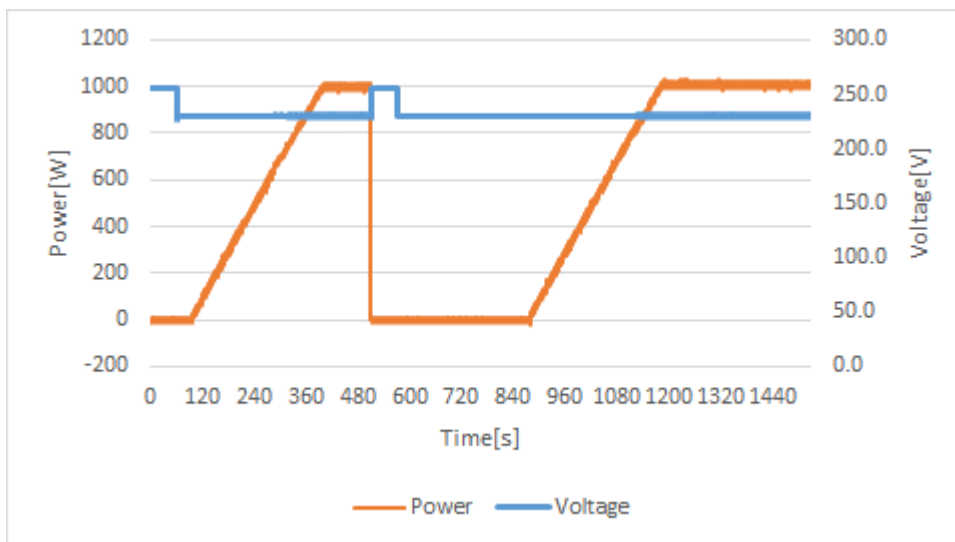
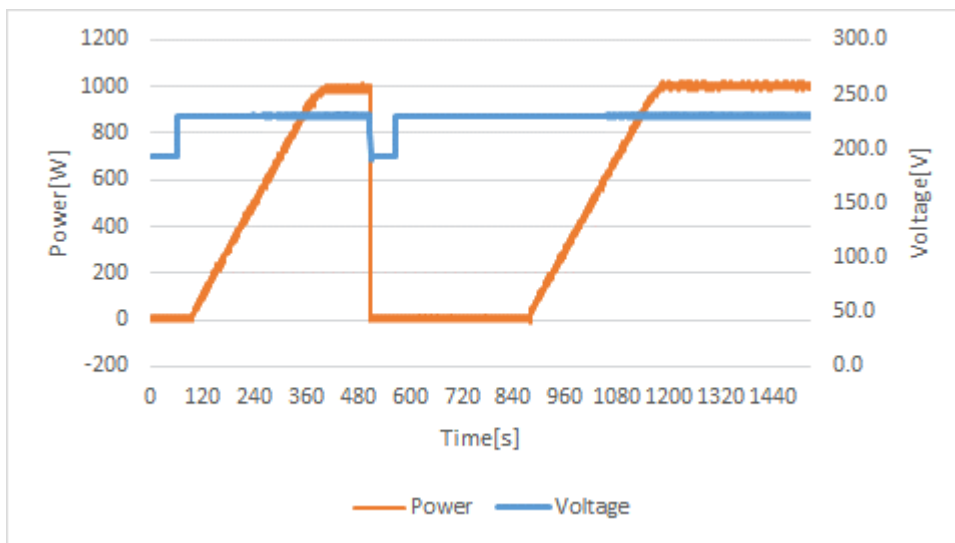

CEI 0-21			
Clause	Requirement - Test	Result - Remark	Verdict

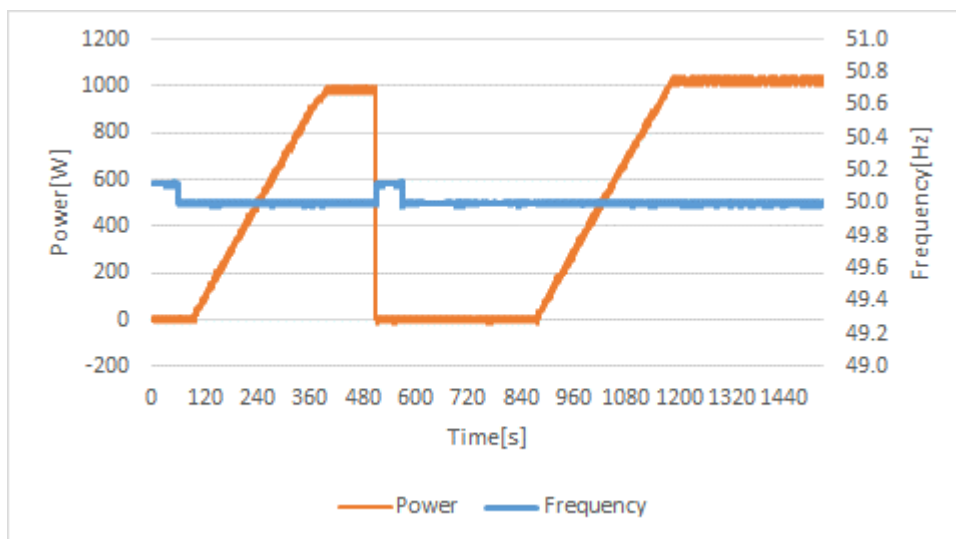
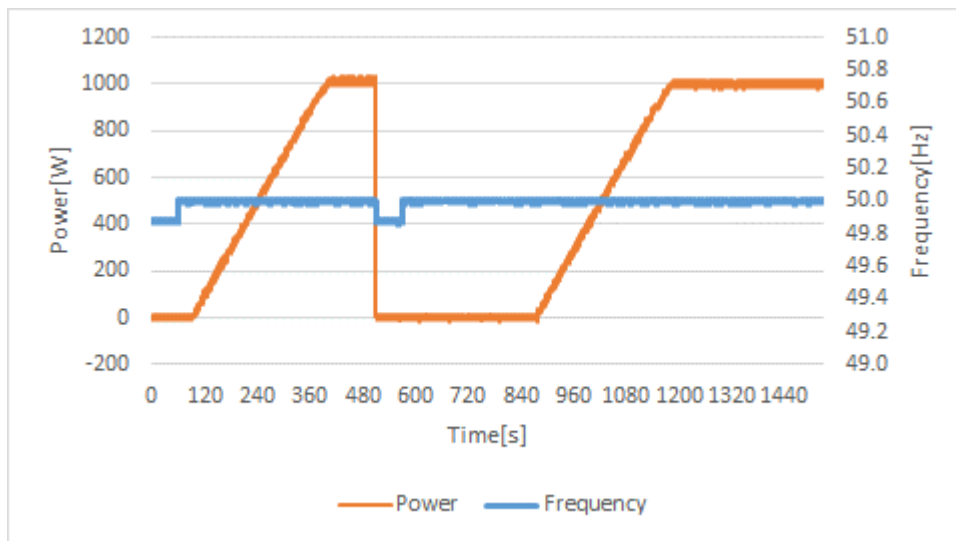

CEI 0-21			
Clause	Requirement - Test	Result - Remark	Verdict

Bbis.6.1 Bbis.6.2	TABLE: Checking construction requirements: reactive power capability	P
------------------------------------	---	----------

Max. cos φ / Q setting point:	<input type="checkbox"/> $P_{SMAX} \leq 11.08 \text{ kW: } \text{Cos } \varphi = 0.9$ <input type="checkbox"/> $P_{SMAX} > 11.08 \text{ kW: } Q/P_n\% = 48.43\%$
--------------------------------------	---

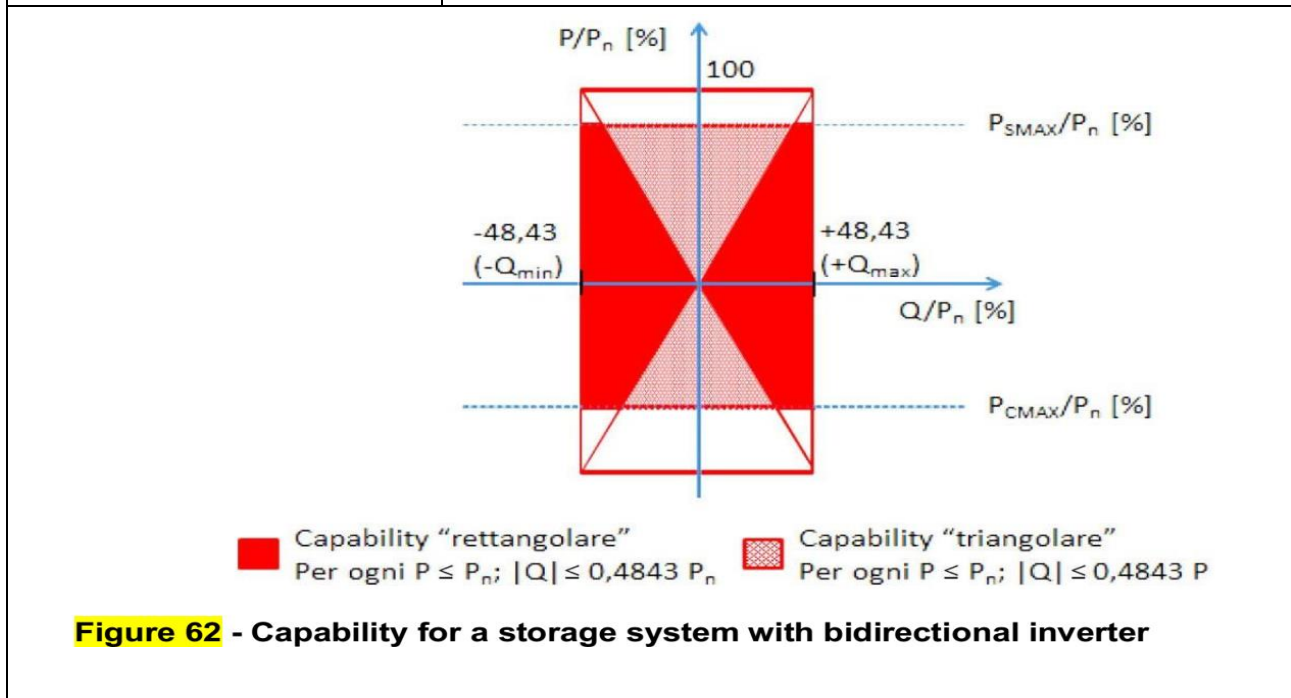

Supplementary information:
 For each of the 10 levels of active power, value of inductive reactive power and value of conductive reactive power must be registered as average values in 1 min, based on the measurements at the fundamental in a window of 200ms.

Positive active power: supply power to the grid
 Negative active power: absorb power from grid
 Positive DC power: charging battery
 Negative DC power: battery discharging

CEI 0-21			
Clause	Requirement - Test	Result - Remark	Verdict

Model	VT-6607106+16Battery
-------	----------------------

TABLE: Reactive power production with set point Q = 0

Power-Bin	Active Power		Reactive Power		DC Power		Power Factor
	W	p.u.	VAr	p.u.	W	p.u.	Cos ϕ
90% -100% P _C MAX	-4050	-98.87%	331	5.51%	-3673	-89.67%	-0.9962
80% -90% P _C MAX	-3646	-89.00%	333	5.55%	-3336	-81.44%	-0.9953
70% -80% P _C MAX	-3242	-79.15%	316	5.27%	-2986	-72.91%	-0.9947
60% -70% P _C MAX	-2825	-68.96%	285	4.76%	-2635	-64.34%	-0.9942
50% -60% P _C MAX	-2416	-58.99%	270	4.50%	-2272	-55.46%	-0.9930
40% -50% P _C MAX	-2006	-48.97%	269	4.48%	-1902	-46.43%	-0.9901
30% -40% P _C MAX	-1601	-39.10%	263	4.38%	-1527	-37.28%	-0.9855
20% -30% P _C MAX	-1194	-29.16%	165	2.75%	-1139	-27.82%	-0.9889
10% -20% P _C MAX	-790	-19.30%	231	3.85%	-734	-17.92%	-0.9576
0% -10% P _C MAX	-378	-9.24%	122	2.04%	-337	-8.24%	-0.9467
0% -10% P _S MAX	374	9.12%	156	2.60%	436	10.65%	0.9180
10% -20% P _S MAX	779	19.03%	193	3.22%	860	21.00%	0.9681
20% -30% P _S MAX	1188	29.01%	160	2.66%	1280	31.24%	0.9894
30% -40% P _S MAX	1605	39.20%	166	2.76%	1708	41.71%	0.9934
40% -50% P _S MAX	2018	49.28%	172	2.87%	2125	51.87%	0.9954
50% -60% P _S MAX	2425	59.20%	173	2.88%	2542	62.06%	0.9967
60% -70% P _S MAX	2828	69.05%	183	3.05%	2956	72.17%	0.9972
70% -80% P _S MAX	3245	79.23%	188	3.14%	3373	82.35%	0.9977
80% -90% P _S MAX	3654	89.21%	200	3.33%	3775	92.16%	0.9980
90% -100% P _S MAX	4063	99.19%	209	3.49%	4173	101.89%	0.9982

TABLE: Reactive power production with set point Q = -Q_{max} (>11.08 kW) or cos ϕ = -0.9 (\leq 11.08 kW)

Power-Bin	Active Power		Reactive Power		DC Power		Power Factor
	W	p.u.	VAr	p.u.	W	p.u.	Cos ϕ
90% -100% P _C MAX	-3901	-95.24%	-2941	-49.01%	-3509	-85.68%	-0.7982
80% -90% P _C MAX	-3636	-88.78%	-2934	-48.91%	-3274	-79.93%	-0.7779
70% -80% P _C MAX	-3230	-78.85%	-2933	-48.88%	-2930	-71.52%	-0.7400
60% -70% P _C MAX	-2814	-68.70%	-2930	-48.83%	-2577	-62.91%	-0.6924
50% -60% P _C MAX	-2411	-58.87%	-2926	-48.77%	-2222	-54.25%	-0.6356
40% -50% P _C MAX	-1999	-48.81%	-2920	-48.67%	-1858	-45.36%	-0.5645
30% -40% P _C MAX	-1583	-38.65%	-2918	-48.63%	-1487	-36.31%	-0.4766
20% -30% P _C MAX	-1182	-28.87%	-2916	-48.61%	-1109	-27.08%	-0.3755

CEI 0-21							
Clause	Requirement - Test			Result - Remark			Verdict
10% -20% P _{CMAX}	-764	-18.65%	-2909	-48.49%	-725	-17.70%	-0.2538
0% -10% P _{CMAX}	-354	-8.64%	-2908	-48.47%	-322	-7.87%	-0.1208
0% -10% P _{SMAX}	345	8.42%	-2911	-48.52%	409	9.98%	0.1175
10% -20% P _{SMAX}	760	18.56%	-2918	-48.63%	827	20.20%	0.2519
20% -30% P _{SMAX}	1170	28.55%	-2921	-48.69%	1276	31.15%	0.3714
30% -40% P _{SMAX}	1588	38.77%	-2928	-48.81%	1703	41.58%	0.4764
40% -50% P _{SMAX}	1996	48.73%	-2935	-48.91%	2130	52.00%	0.5620
50% -60% P _{SMAX}	2415	58.97%	-2938	-48.96%	2546	62.16%	0.6348
60% -70% P _{SMAX}	2814	68.69%	-2944	-49.07%	2966	72.42%	0.6905
70% -80% P _{SMAX}	3226	78.75%	-2947	-49.12%	3378	82.48%	0.7379
80% -90% P _{SMAX}	3637	88.79%	-2949	-49.14%	3792	92.59%	0.7765
90% -100% P _{SMAX}	3893	95.04%	-2953	-49.21%	4056	99.03%	0.7964
TABLE: Reactive power production with set point Q =+Q_{max} (>11.08 kW) or cos φ = +0.9 (≤ 11.08 kW)							
Power-Bin	Active Power		Reactive Power		DC Power		Power Factor
	W	p.u.	VAr	p.u.	W	p.u.	Cos φ
90% -100% P _{CMAX}	-3972	-96.98%	2954	49.24%	-3564	-87.01%	-0.8021
80% -90% P _{CMAX}	-3632	-88.68%	2951	49.18%	-3262	-79.63%	-0.7758
70% -80% P _{CMAX}	-3236	-78.99%	2947	49.12%	-2928	-71.47%	-0.7389
60% -70% P _{CMAX}	-2817	-68.78%	2942	49.04%	-2572	-62.78%	-0.6912
50% -60% P _{CMAX}	-2407	-58.76%	2936	48.94%	-2225	-54.31%	-0.6336
40% -50% P _{CMAX}	-1993	-48.66%	2932	48.86%	-1860	-45.41%	-0.5620
30% -40% P _{CMAX}	-1579	-38.55%	2925	48.74%	-1477	-36.05%	-0.4748
20% -30% P _{CMAX}	-1184	-28.90%	2923	48.71%	-1105	-26.98%	-0.3752
10% -20% P _{CMAX}	-756	-18.46%	2918	48.64%	-714	-17.44%	-0.2506
0% -10% P _{CMAX}	-356	-8.70%	2912	48.54%	-330	-8.06%	-0.1213
0% -10% P _{SMAX}	358	8.73%	2909	48.49%	413	10.07%	0.1219
10% -20% P _{SMAX}	782	19.08%	2917	48.62%	839	20.48%	0.2586
20% -30% P _{SMAX}	1174	28.67%	2920	48.67%	1254	30.61%	0.3728
30% -40% P _{SMAX}	1589	38.78%	2923	48.71%	1678	40.97%	0.4773
40% -50% P _{SMAX}	2001	48.86%	2929	48.81%	2099	51.25%	0.5639
50% -60% P _{SMAX}	2404	58.68%	2936	48.93%	2509	61.26%	0.6331
60% -70% P _{SMAX}	2811	68.63%	2941	49.02%	2919	71.26%	0.6905
70% -80% P _{SMAX}	3227	78.77%	2948	49.13%	3332	81.34%	0.7380
80% -90% P _{SMAX}	3629	88.60%	2955	49.24%	3730	91.06%	0.7752
90% -100% P _{SMAX}	3896	95.12%	2960	49.34%	4002	97.70%	0.7959

CEI 0-21			
Clause	Requirement - Test	Result - Remark	Verdict

Model	VT-6607106+1Battery
-------	---------------------

TABLE: Reactive power production with set point Q = 0

Power-Bin	Active Power		Reactive Power		DC Power		Power Factor
	W	p.u.	VAr	p.u.	W	p.u.	Cos ϕ
90% -100% P _C MAX	-4067	-99.30%	231	3.85%	-3652	-89.17%	-0.9979
80% -90% P _C MAX	-3666	-89.50%	222	3.70%	-3304	-80.66%	-0.9976
70% -80% P _C MAX	-3247	-79.28%	219	3.65%	-2944	-71.88%	-0.9971
60% -70% P _C MAX	-2846	-69.49%	213	3.56%	-2575	-62.88%	-0.9965
50% -60% P _C MAX	-2441	-59.60%	180	3.00%	-2213	-54.02%	-0.9965
40% -50% P _C MAX	-2035	-49.68%	195	3.25%	-1847	-45.09%	-0.9944
30% -40% P _C MAX	-1623	-39.63%	191	3.19%	-1481	-36.15%	-0.9919
20% -30% P _C MAX	-1201	-29.33%	117	1.95%	-1097	-26.79%	-0.9936
10% -20% P _C MAX	-786	-19.19%	139	2.31%	-711	-17.36%	-0.9822
0% -10% P _C MAX	-362	-8.84%	129	2.15%	-332	-8.12%	-0.9371
0% -10% P _S MAX	388	9.47%	233	3.88%	457	11.16%	0.8539
10% -20% P _S MAX	801	19.55%	265	4.42%	875	21.37%	0.9470
20% -30% P _S MAX	1209	29.52%	209	3.48%	1280	31.26%	0.9838
30% -40% P _S MAX	1598	39.02%	207	3.46%	1696	41.40%	0.9904
40% -50% P _S MAX	2015	49.19%	240	4.00%	2113	51.58%	0.9920
50% -60% P _S MAX	2430	59.32%	216	3.60%	2517	61.46%	0.9952
60% -70% P _S MAX	2842	69.38%	227	3.78%	2938	71.74%	0.9961
70% -80% P _S MAX	3239	79.07%	227	3.78%	3344	81.65%	0.9969
80% -90% P _S MAX	3647	89.03%	230	3.84%	3750	91.54%	0.9975
90% -100% P _S MAX	4060	99.11%	238	3.97%	4154	101.41%	0.9978

TABLE: Reactive power production with set point Q = -Q_{max} (>11.08 kW) or cos ϕ = -0.9 (\leq 11.08 kW)

Power-Bin	Active Power		Reactive Power		DC Power		Power Factor
	W	p.u.	VAr	p.u.	W	p.u.	Cos ϕ
90% -100% P _C MAX	-3899	-95.19%	-2956	-49.27%	-3530	-86.17%	-0.7965
80% -90% P _C MAX	-3664	-89.46%	-2950	-49.16%	-3326	-81.21%	-0.7787
70% -80% P _C MAX	-3245	-79.23%	-2944	-49.07%	-2973	-72.58%	-0.7403
60% -70% P _C MAX	-2846	-69.48%	-2940	-49.01%	-2612	-63.78%	-0.6951
50% -60% P _C MAX	-2416	-58.97%	-2934	-48.89%	-2238	-54.64%	-0.6353
40% -50% P _C MAX	-2007	-48.99%	-2927	-48.79%	-1873	-45.74%	-0.5651
30% -40% P _C MAX	-1590	-38.83%	-2925	-48.75%	-1490	-36.38%	-0.4774
20% -30% P _C MAX	-1175	-28.68%	-2924	-48.73%	-1112	-27.14%	-0.3726

CEI 0-21							
Clause	Requirement - Test			Result - Remark			Verdict
10% -20% P _{CMAX}	-779	-19.02%	-2916	-48.61%	-729	-17.80%	-0.2579
0% -10% P _{CMAX}	-367	-8.95%	-2911	-48.51%	-341	-8.32%	-0.1249
0% -10% P _{SMAX}	370	9.03%	-2909	-48.48%	432	10.56%	0.1261
10% -20% P _{SMAX}	778	18.98%	-2914	-48.57%	880	21.48%	0.2576
20% -30% P _{SMAX}	1195	29.17%	-2917	-48.61%	1304	31.83%	0.3788
30% -40% P _{SMAX}	1578	38.52%	-2923	-48.71%	1715	41.88%	0.4747
40% -50% P _{SMAX}	2006	48.97%	-2926	-48.77%	2146	52.39%	0.5651
50% -60% P _{SMAX}	2415	58.95%	-2931	-48.84%	2573	62.82%	0.6356
60% -70% P _{SMAX}	2819	68.82%	-2933	-48.88%	2982	72.80%	0.6927
70% -80% P _{SMAX}	3240	79.11%	-2935	-48.92%	3405	83.14%	0.7408
80% -90% P _{SMAX}	3628	88.56%	-2939	-48.99%	3810	93.01%	0.7766
90% -100% P _{SMAX}	3868	94.43%	-2943	-49.06%	4053	98.95%	0.7955
TABLE: Reactive power production with set point Q =+Q_{max} (>11.08 kW) or cos φ = +0.9 (≤ 11.08 kW)							
Power-Bin	Active Power		Reactive Power		DC Power		Power Factor
	W	p.u.	VAr	p.u.	W	p.u.	Cos φ
90% -100% P _{CMAX}	-3707	-90.51%	2941	49.02%	-3466	-84.63%	-0.7830
80% -90% P _{CMAX}	-3509	-85.66%	2939	48.99%	-3138	-76.61%	-0.7662
70% -80% P _{CMAX}	-3253	-79.41%	2935	48.92%	-2903	-70.88%	-0.7420
60% -70% P _{CMAX}	-2844	-69.44%	2930	48.84%	-2563	-62.56%	-0.6961
50% -60% P _{CMAX}	-2449	-59.78%	2924	48.73%	-2203	-53.77%	-0.6418
40% -50% P _{CMAX}	-2037	-49.73%	2922	48.70%	-1845	-45.06%	-0.5716
30% -40% P _{CMAX}	-1607	-39.23%	2921	48.68%	-1467	-35.80%	-0.4818
20% -30% P _{CMAX}	-1197	-29.24%	2914	48.57%	-1094	-26.70%	-0.3798
10% -20% P _{CMAX}	-801	-19.56%	2912	48.54%	-721	-17.59%	-0.2651
0% -10% P _{CMAX}	-359	-8.76%	2912	48.53%	-300	-7.34%	-0.1222
0% -10% P _{SMAX}	362	8.83%	2912	48.54%	403	9.85%	0.1232
10% -20% P _{SMAX}	776	18.95%	2916	48.59%	839	20.49%	0.2571
20% -30% P _{SMAX}	1197	29.23%	2918	48.63%	1254	30.61%	0.3794
30% -40% P _{SMAX}	1595	38.94%	2920	48.66%	1660	40.53%	0.4791
40% -50% P _{SMAX}	2020	49.31%	2924	48.74%	2082	50.84%	0.5679
50% -60% P _{SMAX}	2422	59.14%	2930	48.84%	2490	60.79%	0.6368
60% -70% P _{SMAX}	2828	69.04%	2936	48.93%	2892	70.60%	0.6934
70% -80% P _{SMAX}	3143	76.72%	2942	49.03%	3212	78.43%	0.7297
80% -90% P _{SMAX}	3532	86.24%	2948	49.13%	3590	87.66%	0.7674
90% -100% P _{SMAX}	3866	94.39%	2949	49.16%	3944	96.29%	0.7948

CEI 0-21			
Clause	Requirement - Test	Result - Remark	Verdict

Model	VT-6607100+1Battery
-------	---------------------

TABLE: Reactive power production with set point Q = 0

Power-Bin	Active Power		Reactive Power		DC Power		Power Factor
	W	p.u.	VAr	p.u.	W	p.u.	Cos ϕ
90% -100% P _{CMAX}	-996	-99.62%	236	23.64%	-896	-89.57%	-0.9711
80% -90% P _{CMAX}	-890	-89.00%	152	15.17%	-798	-79.81%	-0.9836
70% -80% P _{CMAX}	-786	-78.60%	124	12.42%	-708	-70.79%	-0.9851
60% -70% P _{CMAX}	-689	-68.87%	138	13.76%	-619	-61.86%	-0.9777
50% -60% P _{CMAX}	-598	-59.78%	143	14.26%	-526	-52.58%	-0.9693
40% -50% P _{CMAX}	-494	-49.36%	155	15.52%	-435	-43.52%	-0.9501
30% -40% P _{CMAX}	-389	-38.92%	164	16.44%	-341	-34.06%	-0.9167
20% -30% P _{CMAX}	-298	-29.84%	126	12.62%	-245	-24.54%	-0.9153
10% -20% P _{CMAX}	-191	-19.11%	147	14.69%	-150	-15.00%	-0.7864
0% -10% P _{CMAX}	-87	-8.68%	137	13.71%	-49	-4.94%	-0.5281
0% -10% P _{SMAX}	90	9.02%	129	12.89%	128	12.79%	0.5662
10% -20% P _{SMAX}	186	18.64%	140	13.98%	225	22.46%	0.7934
20% -30% P _{SMAX}	289	28.93%	170	16.99%	344	34.40%	0.8571
30% -40% P _{SMAX}	394	39.43%	180	18.00%	445	44.45%	0.9055
40% -50% P _{SMAX}	496	49.65%	180	18.05%	546	54.55%	0.9363
50% -60% P _{SMAX}	595	59.47%	165	16.45%	644	64.44%	0.9605
60% -70% P _{SMAX}	699	69.94%	134	13.38%	750	75.00%	0.9794
70% -80% P _{SMAX}	799	79.87%	143	14.26%	850	85.05%	0.9820
80% -90% P _{SMAX}	894	89.36%	146	14.61%	949	94.90%	0.9847
90% -100% P _{SMAX}	990	99.00%	145	14.52%	1048	104.80%	0.9874

TABLE: Reactive power production with set point Q = -Q_{max} (>11.08 kW) or cos ϕ = -0.9 (\leq 11.08 kW)

Power-Bin	Active Power		Reactive Power		DC Power		Power Factor
	W	p.u.	VAr	p.u.	W	p.u.	Cos ϕ
90% -100% P _{CMAX}	-893	-89.31%	-489	-48.86%	-825	-82.51%	-0.8756
80% -90% P _{CMAX}	-886	-88.62%	-488	-48.85%	-820	-81.99%	-0.8740
70% -80% P _{CMAX}	-776	-77.56%	-487	-48.75%	-719	-71.90%	-0.8447
60% -70% P _{CMAX}	-686	-68.60%	-488	-48.76%	-630	-62.97%	-0.8131
50% -60% P _{CMAX}	-588	-58.76%	-488	-48.77%	-537	-53.69%	-0.7675
40% -50% P _{CMAX}	-487	-48.66%	-488	-48.76%	-443	-44.27%	-0.7042
30% -40% P _{CMAX}	-387	-38.69%	-486	-48.64%	-350	-35.01%	-0.6204
20% -30% P _{CMAX}	-284	-28.36%	-486	-48.56%	-258	-25.77%	-0.5025

CEI 0-21							
Clause	Requirement - Test			Result - Remark			Verdict
10% -20% P _{CMAX}	-180	-18.04%	-485	-48.55%	-164	-16.37%	-0.3469
0% -10% P _{CMAX}	-84	-8.38%	-484	-48.45%	-60	-5.95%	-0.1698
0% -10% P _{SMAX}	81	8.06%	-484	-48.43%	126	12.59%	0.1635
10% -20% P _{SMAX}	193	19.32%	-485	-48.53%	231	23.14%	0.3684
20% -30% P _{SMAX}	279	27.91%	-487	-48.67%	330	33.02%	0.4955
30% -40% P _{SMAX}	380	37.96%	-487	-48.74%	431	43.09%	0.6125
40% -50% P _{SMAX}	484	48.44%	-488	-48.84%	531	53.08%	0.7022
50% -60% P _{SMAX}	591	59.14%	-489	-48.86%	637	63.68%	0.7689
60% -70% P _{SMAX}	677	67.73%	-490	-48.96%	736	73.57%	0.8085
70% -80% P _{SMAX}	788	78.78%	-491	-49.05%	837	83.68%	0.8471
80% -90% P _{SMAX}	880	88.02%	-491	-49.06%	939	93.87%	0.8717
90% -100% P _{SMAX}	897	89.75%	-492	-49.16%	949	94.94%	0.8753
TABLE: Reactive power production with set point Q =+Q_{max} (>11.08 kW) or cos φ = +0.9 (≤ 11.08 kW)							
Power-Bin	Active Power		Reactive Power		DC Power		Power Factor
	W	p.u.	VAr	p.u.	W	p.u.	Cos φ
90% -100% P _{CMAX}	-890	-88.95%	493	49.35%	-796	-79.61%	-0.8727
80% -90% P _{CMAX}	-881	-88.07%	493	49.26%	-786	-78.56%	-0.8710
70% -80% P _{CMAX}	-781	-78.13%	492	49.16%	-695	-69.47%	-0.8446
60% -70% P _{CMAX}	-683	-68.32%	491	49.05%	-606	-60.58%	-0.8104
50% -60% P _{CMAX}	-576	-57.65%	490	49.05%	-513	-51.27%	-0.7596
40% -50% P _{CMAX}	-480	-47.97%	489	48.94%	-420	-42.01%	-0.6978
30% -40% P _{CMAX}	-378	-37.83%	488	48.84%	-330	-32.98%	-0.6104
20% -30% P _{CMAX}	-289	-28.89%	487	48.74%	-241	-24.07%	-0.5080
10% -20% P _{CMAX}	-181	-18.07%	486	48.63%	-145	-14.54%	-0.3468
0% -10% P _{CMAX}	-84	-8.38%	487	48.67%	-45	-4.50%	-0.1689
0% -10% P _{SMAX}	83	8.25%	486	48.57%	127	12.67%	0.1667
10% -20% P _{SMAX}	184	18.40%	488	48.76%	229	22.87%	0.3515
20% -30% P _{SMAX}	286	28.55%	487	48.74%	326	32.57%	0.5035
30% -40% P _{SMAX}	395	39.46%	489	48.86%	428	42.78%	0.6262
40% -50% P _{SMAX}	483	48.29%	489	48.86%	529	52.90%	0.7008
50% -60% P _{SMAX}	591	59.06%	490	48.96%	628	62.77%	0.7678
60% -70% P _{SMAX}	682	68.21%	490	49.03%	728	72.83%	0.8101
70% -80% P _{SMAX}	782	78.21%	492	49.15%	824	82.36%	0.8449
80% -90% P _{SMAX}	871	87.11%	493	49.25%	916	91.55%	0.8687
90% -100% P _{SMAX}	896	89.57%	494	49.35%	936	93.56%	0.8741

CEI 0-21			
Clause	Requirement - Test	Result - Remark	Verdict

Bbis.6.3 Bbis.6.4	TABLE: Reactive power production according to an assigned level (Required for inverter used in plant > 11.08 kW)			P
Model	VT-6607106+16Battery			
Power meter measurment data:	Sample-Rate:	0.2 s		
	Samples time:	3 min for each power point		
P_N in %	$Q_{min}/\cos\varphi$ min (180s)	$Q=0/\cos\varphi=0$ (180s)	$Q_{max}/\cos\varphi$ max (180s)	
file: 50% P_{SMAX}				
50% P_N	Reactive power Set point Q/S_n [%]	Reactive power measured Q/S_n [%]	Deviation from set point $\Delta Q/S_n$ [%]	Limit [%]
$-Q_{min}$ (=40% S_n)	-40.00	-39.96	0.04	$\Delta Q \leq \pm 5\% S_n$
0	0.00	-2.23	-2.23	$\Delta Q \leq \pm 5\% S_n$
$+Q_{max}$ (=40% S_n)	40.00	40.58	0.58	$\Delta Q \leq \pm 5\% S_n$

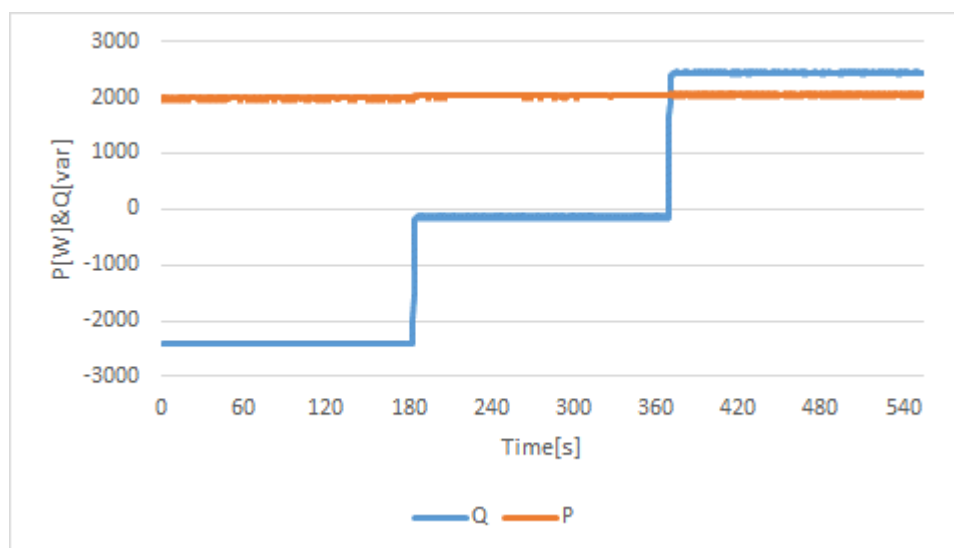

Test procedure:

c) The test must be performed according to the following steps:

- bring the generator to 50% of the maximum active power available in discharge;
- send to the generator an inductive reactive power set-point equal to 40% of the rated power of the converter (S_n);
- maintain the set-point for a time of 60 s, compatibly with the energy capacity of the storage system;
- measure the reactive power delivered by the inverter, at least 30 seconds after the command of the new reactive power regulation set-point is sent (this is to ensure that the system has reached the steady state).

The test is considered successfully passed if the maximum deviation between the assigned level and the current measured value (average value with 1 min window) for the reactive power is equal to:

- $\Delta Q \leq \pm 5\%$ the nominal apparent power of the converter (direct setting of the reactive power level);
- $\Delta \cos \varphi \leq \pm 0,01$ (setting via power factor).

d) In the case of storage systems connected to bidirectional converters, the test must also be repeated in the condition of withdrawal of energy from the grid.

CEI 0-21			
Clause	Requirement - Test	Result - Remark	Verdict

Bbis.6.3 Bbis.6.4	TABLE: reactive power production according to an assigned level (Required for inverter used in plant > 11.08 kW)			P
Model	VT-6607106+16Battery			
Power meter measurement data:	Sample-Rate:	0.2 s		
	Samples time:	3 min for each power point		
P (%)	Qmin/cosφ min (180s)	Q=0/ cosφ=0 (180s)	Qmax/cosφ max (180s)	
file: 50% P _C MAX				
50% P _N	Reactive power Set point Q/S _n [%]	Reactive power measured Q/S _n [%]	Deviation from set point ΔQ/S _n [%]	Limit [%]
-Q _{min} (=40%S _n)	-40.00	-40.06	-0.06	ΔQ ≤ ±5% S _n
0	0.00	-2.42	-2.42	ΔQ ≤ ±5% S _n
+Q _{max} (=40%S _n)	40.00	40.29	0.29	ΔQ ≤ ±5% S _n

Test procedure:

c) The test must be performed according to the following steps:

- bring the generator to 50% of the maximum active power available in discharge;
- send to the generator an inductive reactive power set-point equal to 40% of the rated power of the converter (S_n);
- maintain the set-point for a time of 60 s, compatibly with the energy capacity of the storage system;
- measure the reactive power delivered by the inverter, at least 30 seconds after the command of the new reactive power regulation set-point is sent (this is to ensure that the system has reached the steady state).

The test is considered successfully passed if the maximum deviation between the assigned level and the current measured value (average value with 1 min window) for the reactive power is equal to:

- ΔQ ≤ ±5 % the nominal apparent power of the converter (direct setting of the reactive power level);
- Δcos φ ≤ ±0,01 (setting via power factor).

d) In the case of storage systems connected to bidirectional converters, the test must also be repeated in the condition of withdrawal of energy from the grid.

CEI 0-21			
Clause	Requirement - Test	Result - Remark	Verdict

Bbis.6.5	TABLE: Response time to a step change of the assigned level (Required for inverter used in plant > 11.08 kW)		P
Model	VT-6607106+16Battery		
Power meter measurement data:	Sample-Rate:	0,2 s	
	Samples time:	at least 2 minutes for each power point	

Test:

- From the results of the capability tests referred to in Paragraphs Bbis.6.1 and Bbis.6.2, the $Q_{\max|cap}$ and $Q_{\max|ind}$ values of the maximum capacitive and inductive reactive power that can be supplied by the converter at 50% and 100% of the active discharge power maximum ($P_{S_{MAX}}$; for integrated storage systems, equal to $P_{N_{INV}}$) and maximum charge, $P_{C_{MAX}}$ (for storage systems connected to bidirectional converters).
- The values measured as averages at 0.2 s of the reactive power during the execution of reactive power regulation commands with step variations, when the storage system respectively delivers a power, should be reported in a graph similar to the exemplary one in Figure 65. active equal to 50% (Test 1) and 100% of the maximum active discharge / charge power (Test 2).
- Note the response time (T_r = settling time in the graph in Figure 65), which is equivalent to the time interval that elapses from the instant of application of the new set-point to the instant in which the reactive power reaches an overall value. within an interval included within a band of $\pm 5\% * S_n$ of the new assigned value.
- As shown in Figure 65, the response time must be detected in correspondence with a variation of the set-point from zero to $Q_{\max|ind}$ (step 1), from $Q_{\max|ind}$ to $Q_{\max|cap}$ (step 2) and from $Q_{\max|cap}$ to zero (step 3).

The response time values must be documented in the test report, which must also indicate the values of $Q_{\max|cap}$, $Q_{\max|ind}$, of the active power delivered / absorbed during the test and the method used to send the set control command point of reactive power.

The test is passed if the maximum response time detected is less than 10 s under all measurement conditions.

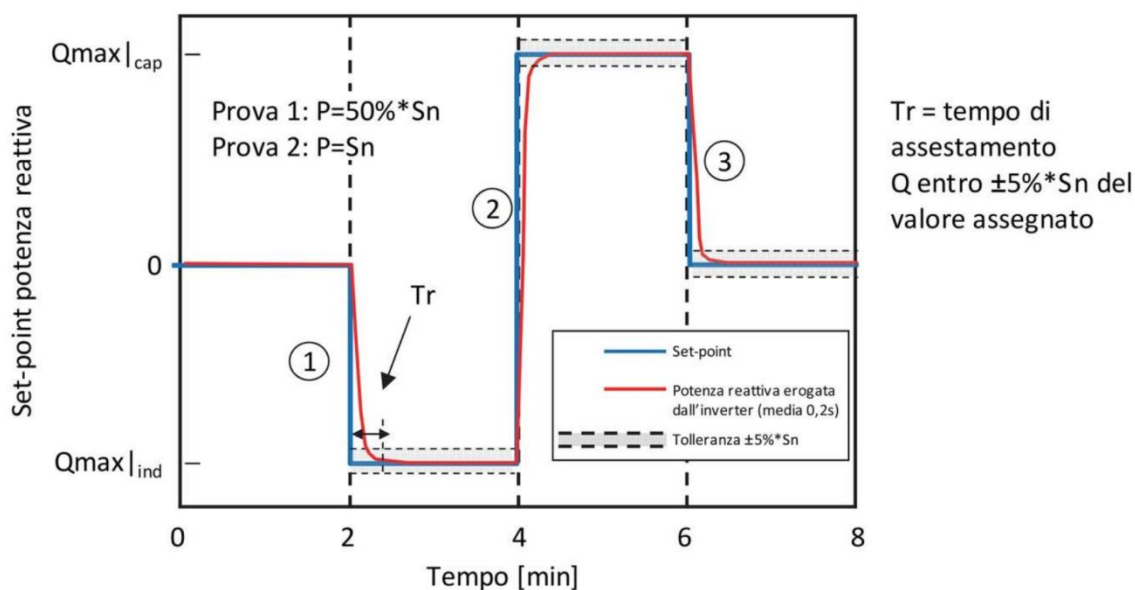

Figure 65 - Measurement of the response time to step changes of the set-point assigned for the reactive power

CEI 0-21

Clause	Requirement - Test	Result - Remark	Verdict
--------	--------------------	-----------------	---------

Test 1 (see Graph 1): 100%P_SMAX

Point	Output power [W]	transient	Vac [V]	Q [VAr]	Tr [s]	Limit [s]
1	4061	0 @ Q _{max ind}	230.26	-2904	2.0	10
2	4093	Q _{max ind} @ Q _{max cap}	230.50	2904	2.2	10
3	4093	Q _{max cap} @ 0	230.41	-169	2.0	10

Test 2 (see Graph 2): 50%P_SMAX

Point	Output power [W]	transient	Vac [V]	Q [VAr]	Tr [s]	Limit [s]
1	2051	0 @ Q _{max ind}	229.89	-2895	2.2	10
2	2055	Q _{max ind} @ Q _{max cap}	230.12	2904	2.8	10
3	2054	Q _{max cap} @ 0	230.01	-140	2.0	10

Graph 1 of the reaction time after a step variation of the assigned level (100%-Test 1)

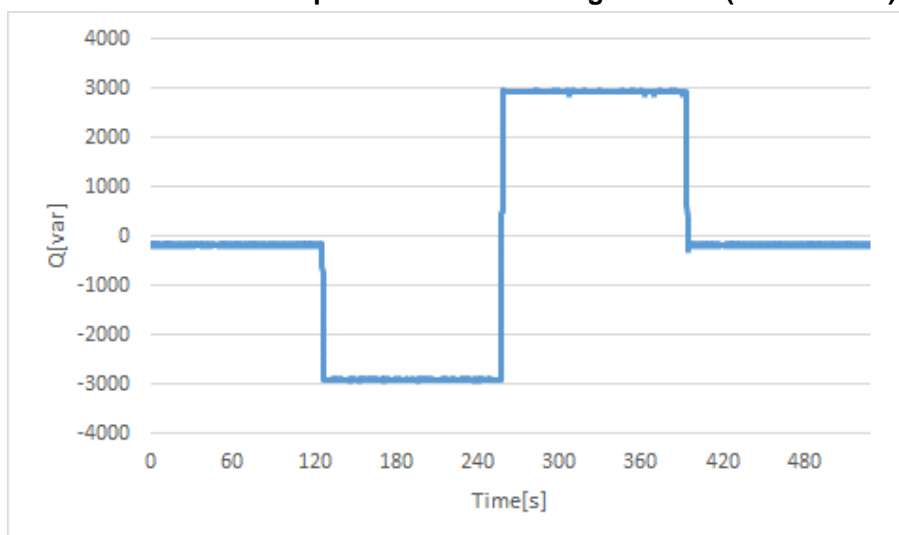

Graph 2 of the reaction time after a step variation of the assigned level (50%-Test 2)

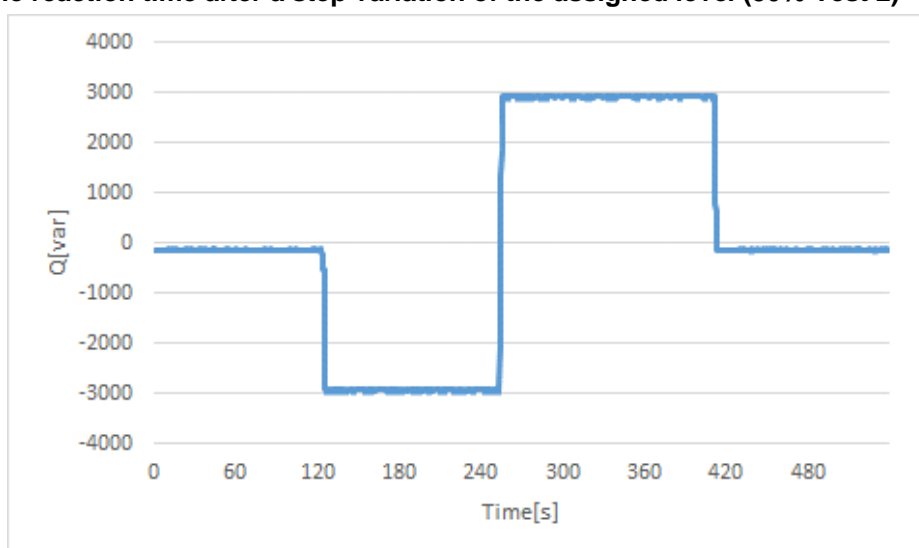

CEI 0-21

Clause	Requirement - Test	Result - Remark	Verdict
--------	--------------------	-----------------	---------

Test 1 (see Graph 1): 100%P_{C_{MAX}}

Point	Output power [W]	transient	Vac [V]	Q [VAr]	Tr [s]	Limit [s]
1	-4090	0 @ Q _{max ind}	230.10	-2871	4.6	10
2	-4056	Q _{max ind} @ Q _{max cap}	229.85	2881	3.8	10
3	-4092	Q _{max cap} @ 0	229.97	175	3.2	10

Test 2 (see Graph 2): 50%P_{C_{max}}

Point	Output power [W]	transient	Vac [V]	Q [VAr]	Tr [s]	Limit [s]
1	-2053	0 @ Q _{max ind}	230.19	-2895	3.4	10
2	-2049	Q _{max ind} @ Q _{max cap}	229.97	2907	3.2	10
3	-2052	Q _{max cap} @ 0	230.08	132	3.0	10

Graph 1 of the reaction time after a step variation of the assigned level (100%-Test 1)

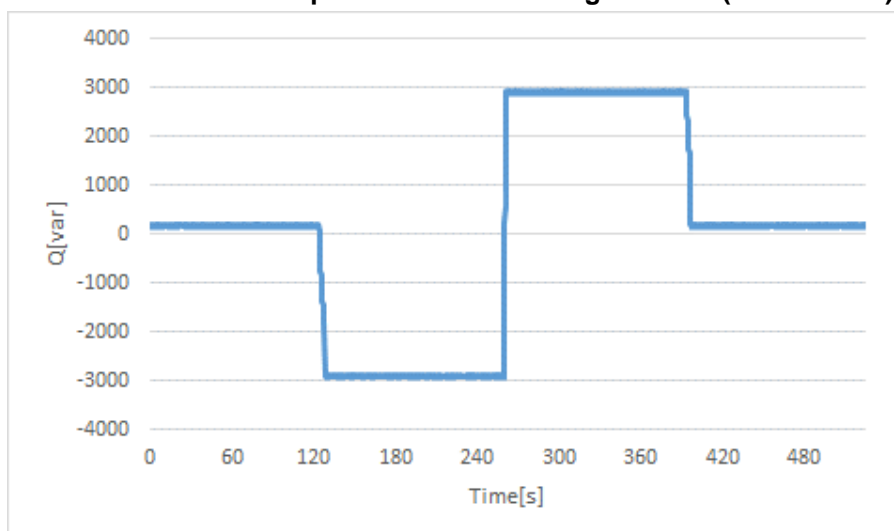

Graph 2 of the reaction time after a step variation of the assigned level (50%-Test 2)

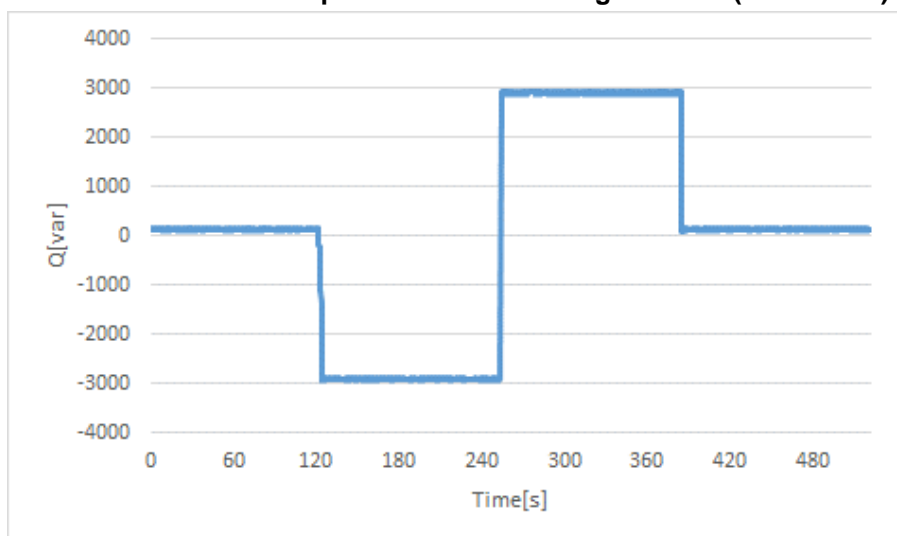

CEI 0-21			
Clause	Requirement - Test	Result - Remark	Verdict

Bbis.6.6	TABLE: Automatic production of reactive power according to a characteristic	P
Bbis.6.7	curve $\cos\phi = f(P)$	
Max. $\cos\phi$ declared.....		$\cos\phi$: 0.9
Set value.....		Lock-in: 1.05 Vn (Vn and 1.1 Vn with steps of 0.01) Lock-out: 0.98 Vn (0.9 Vn and Vn with steps of 0.01)
<p>Figure 66 - Standard characteristic curve $\cos\phi = f(P)$</p>		
<p>A: $P = 20\% \cdot P_{SMAX}$; $\cos\phi = 1$</p> <p>B: $P = 50\% \cdot P_{SMAX}$; $\cos\phi = 1$</p> <p>C: $P = P_{SMAX}$; $\cos\phi = \cos\phi_{min}$</p> <p>where $\cos\phi_{min}$ is equal to 0.90 (inductive).</p> <p>The automatic adjustment mode is disabled when:</p> <ul style="list-style-type: none"> the active power P delivered falls below 50% of P_{SMAX} (point B), or P_{NINV} for integrated storage systems, defined as power lock-out, independent of the voltage at the terminals, or the voltage read at the output terminals of the converter falls below the lock-out limit, to be set at a default value equal to Vn, but which must be adjustable in the interval between $0.9 \cdot Vn$ and Vn with intervals of $0.01 \cdot Vn$. 		
<p>Supplementary information:</p> <ul style="list-style-type: none"> Function must be enabled by a local command of the converter. Each value must be reach in < 10s. 		

CEI 0-21			
Clause	Requirement - Test	Result - Remark	Verdict

Model: VT-6607106+16Battery								
P/P_{SMAX} [%]	P[W]	Vout[V]	Q[Var]	Cos φ Setpoint	Cos φ measured	Δ Cos φ	Limit Δ cos φ _max	Result
20	820	238.33	106	1.00	0.992	-0.008	$\leq \pm 0.01$	P
30	1236	238.47	126	1.00	0.995	-0.005	$\leq \pm 0.01$	P
40	1648	238.57	132	1.00	0.997	-0.003	$\leq \pm 0.01$	P
50	2057	238.33	142	1.00	0.998	-0.002	$\leq \pm 0.01$	P
60	2463	237.96	151	1.00	0.998	-0.002	$\leq \pm 0.01$	P
60	2467	245.00	478	0.98	0.981	0.001	$\leq \pm 0.01$	P
70	2876	245.68	865	0.96	0.958	-0.002	$\leq \pm 0.01$	P
80	3285	245.96	1219	0.94	0.938	-0.002	$\leq \pm 0.01$	P
90	3692	245.88	1604	0.92	0.917	-0.003	$\leq \pm 0.01$	P
100	4085	245.95	1973	0.90	0.900	0.000	$\leq \pm 0.01$	P
100	4095	231.99	1994	0.90	0.899	-0.001	$\leq \pm 0.01$	P
100	4090	224.54	182	1.00	0.999	-0.001	$\leq \pm 0.01$	P

Graph reactive power production according to a characteristic curve $\cos(\phi) = f(P)$

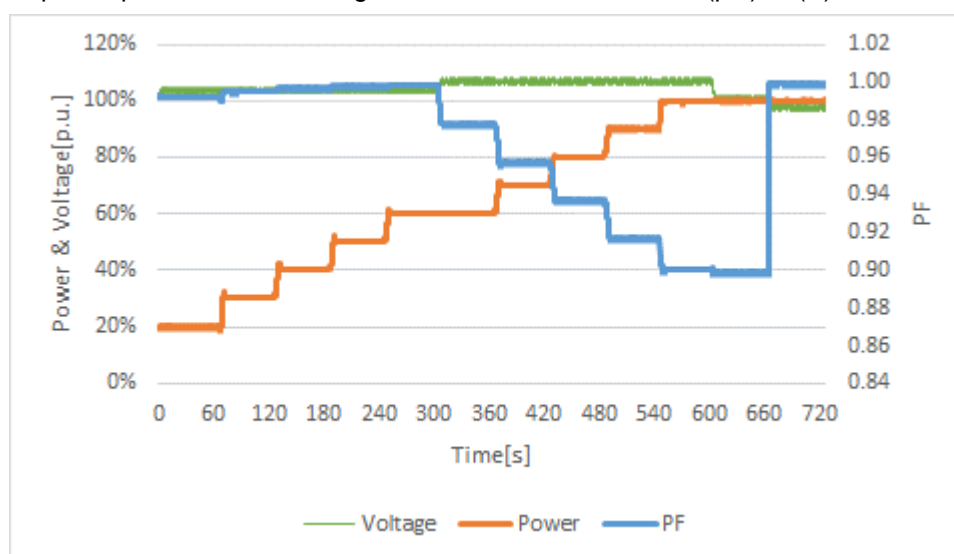

CEI 0-21			
Clause	Requirement - Test	Result - Remark	Verdict

Model: VT-6607106+1Battery								
P/P_{SMAX} [%]	P[W]	Vout[V]	Q[Var]	Cos φ Setpoint	Cos φ measured	Δ Cos φ	Limit Δ cos φ _max	Result
20	813	238.75	107	1.00	0.992	-0.008	$\leq \pm 0.01$	P
30	1225	238.87	146	1.00	0.993	-0.007	$\leq \pm 0.01$	P
40	1637	239.05	194	1.00	0.993	-0.007	$\leq \pm 0.01$	P
50	2044	239.03	198	1.00	0.995	-0.005	$\leq \pm 0.01$	P
60	2450	238.75	205	1.00	0.996	-0.004	$\leq \pm 0.01$	P
60	2455	245.38	500	0.98	0.978	-0.002	$\leq \pm 0.01$	P
70	2865	246.40	903	0.96	0.954	-0.006	$\leq \pm 0.01$	P
80	3272	246.41	1194	0.94	0.939	-0.001	$\leq \pm 0.01$	P
90	3682	246.71	1608	0.92	0.916	-0.004	$\leq \pm 0.01$	P
100	4096	246.67	1993	0.90	0.899	-0.001	$\leq \pm 0.01$	P
100	4120	232.89	1985	0.90	0.901	0.001	$\leq \pm 0.01$	P
100	4116	225.13	266	1.00	0.998	-0.002	$\leq \pm 0.01$	P

Graph reactive power production according to a characteristic curve $\cos(\phi) = f(P)$

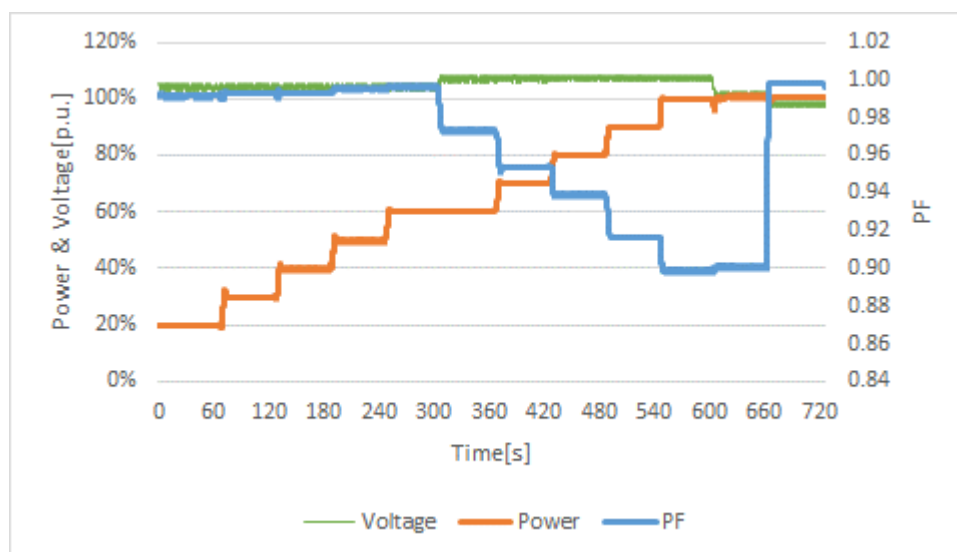

CEI 0-21			
Clause	Requirement - Test	Result - Remark	Verdict

Model: VT-6607100+1Battery								
P/P_{SMAX} [%]	P[W]	Vout[V]	Q[Var]	Cos φ Setpoint	Cos φ measured	Δ Cos φ	Limit Δ cos φ _max	Result
20	215	237.01	29	1.00	0.990	-0.010	$\leq \pm 0.01$	P
30	320	237.07	36	1.00	0.993	-0.007	$\leq \pm 0.01$	P
40	425	237.15	51	1.00	0.994	-0.006	$\leq \pm 0.01$	P
50	523	237.24	46	1.00	0.996	-0.004	$\leq \pm 0.01$	P
60	625	237.39	53	1.00	0.996	-0.004	$\leq \pm 0.01$	P
60	627	244.39	142	0.98	0.975	-0.005	$\leq \pm 0.01$	P
70	712	244.52	225	0.96	0.953	-0.007	$\leq \pm 0.01$	P
80	807	244.62	301	0.94	0.937	-0.003	$\leq \pm 0.01$	P
90	911	244.68	403	0.92	0.915	-0.005	$\leq \pm 0.01$	P
100	919	244.69	449	0.90	0.898	-0.002	$\leq \pm 0.01$	P
100	906	230.96	422	0.90	0.907	0.007	$\leq \pm 0.01$	P
100	986	223.42	47	1.00	0.999	-0.001	$\leq \pm 0.01$	P

Graph reactive power production according to a characteristic curve $\cos(\phi) = f(P)$

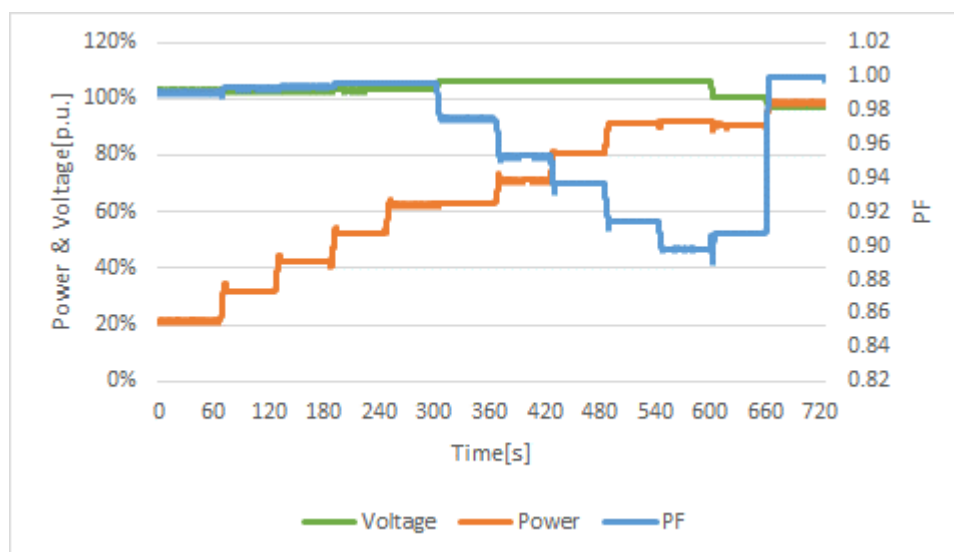

CEI 0-21			
Clause	Requirement - Test	Result - Remark	Verdict

Bbis.6.8	TABLE: Automatic reactive power production according to a characteristic curve	P
Bbis.6.9	Q = f(V) (Required for inverter used in plant ≥ 11.08 kW)	

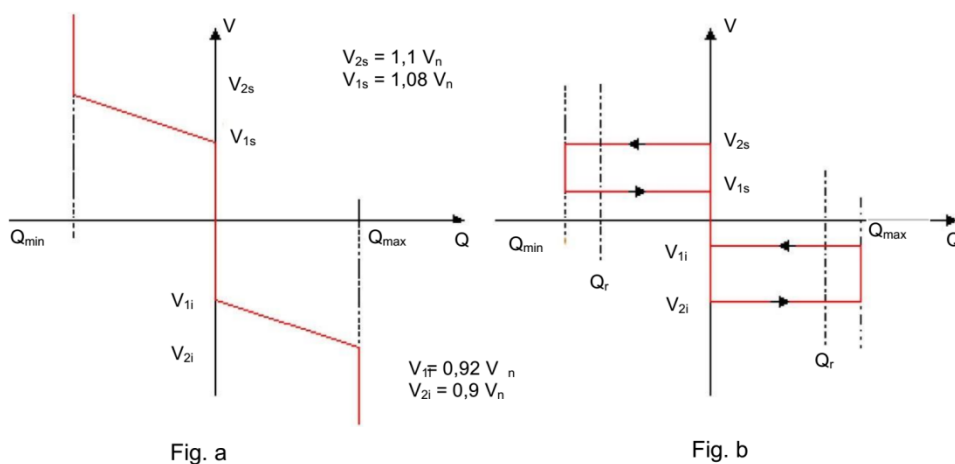

Figure 51 - Standard characteristic curves Q = f (V)

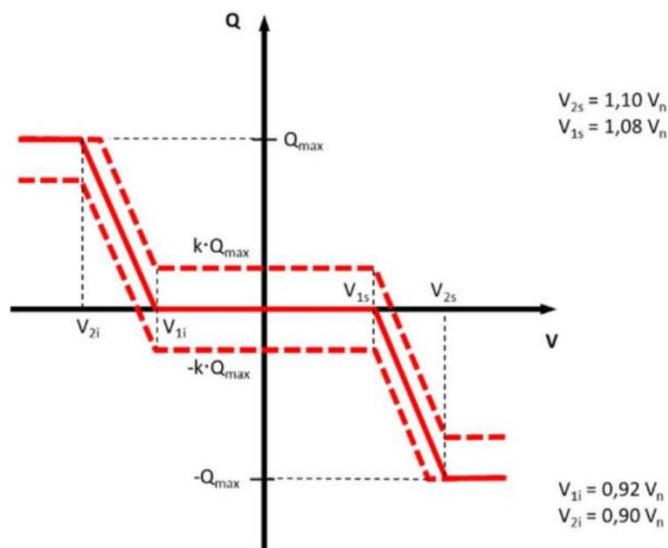

Figure 67 - Standard characteristic curve Q = f (V)

Q = f (V) standard curve default setting value:

Lock-in--> 20%P_SMAX (or P_NINV) and > 20%P_CMAX for bidirectional EESS

Lock-out --> ≤ 5%P_SMAX (or P_NINV) and ≤ 5%P_CMAX for bidirectional EESS

V_{1s} = 1.08V_n; V_{2s} = 1.1V_n;

V_{1i} = 0.92V_n ; V_{2i} = 0.9V_n;

k = 0.1

delay's time of reactive power = 3 seconds

CEI 0-21			
Clause	Requirement - Test	Result - Remark	Verdict

Curve A.1 - Test for bidirectional EESS in DISCHARGE with $k = +0.1$						
Setting Power [%]	Setting Voltage [V]	Output Power [W]	Voltage [V]	Reactive Power [Var]	Reactive Power expected [Var]	ΔQ
<20%P _S MAX	1.07V _n	744.09	246.07	138.14	k*Q _{max}	≤5%Sn
<20%P _S MAX	1.09V _n	743.54	250.55	137.26	k*Q _{max}	≤5%Sn
30%P _S MAX	1.09V _n	1235.48	250.67	-1164.98	-0.4*Q _{max} (lock-in) <i>within 10sec</i>	≤5%Sn
40%P _S MAX	1.09V _n	1650.99	250.75	-1175.15	-0.4*Q _{max}	≤5%Sn
50%P _S MAX	1.09V _n	2059.88	250.79	-1181.20	-0.4*Q _{max}	≤5%Sn
60%P _S MAX	1.09V _n	2467.51	250.89	-1197.76	-0.4*Q _{max}	≤5%Sn
70%P _S MAX	1.09V _n	2870.16	250.97	-1217.88	-0.4*Q _{max}	≤5%Sn
80%P _S MAX	1.09V _n	3290.87	251.01	-1230.35	-0.4*Q _{max}	≤5%Sn
90%P _S MAX	1.09V _n	3697.23	251.11	-1263.94	-0.4*Q _{max}	≤5%Sn
100%P _S MAX	1.09V _n	4098.35	251.18	-1314.19	-0.4*Q _{max}	≤5%Sn
100%P _S MAX	1.1V _n	4104.50	253.40	-2604.86	-0.9*Q _{max}	≤5%Sn
10%P _S MAX	1.1V _n	414.28	252.77	-2529.42	-0.9*Q _{max}	≤5%Sn
≤5%P _S MAX	1.1V _n	161.94	252.80	121.11	k*Q _{max} (lock-out)	≤5%Sn
Curve B.1 - Test for bidirectional EESS in DISCHARGE with $k = +0.1$						
Setting Power [%]	Setting Voltage [V]	Output Power [W]	Voltage [V]	Reactive Power [Var]	Reactive Power expected [Var]	ΔQ
<20%P _S MAX	0.93V _n	740.97	213.65	176.09	k*Q _{max}	≤5%Sn
<20%P _S MAX	0.91V _n	743.17	209.10	177.06	k*Q _{max}	≤5%Sn
30%P _S MAX	0.91V _n	1237.85	209.28	1651.48	0.6*Q _{max} (lock-in) <i>within 10sec</i>	≤5%Sn
40%P _S MAX	0.91V _n	1654.20	209.37	1647.71	0.6*Q _{max}	≤5%Sn
50%P _S MAX	0.91V _n	2061.98	209.44	1597.67	0.6*Q _{max}	≤5%Sn
60%P _S MAX	0.91V _n	2471.00	209.52	1569.82	0.6*Q _{max}	≤5%Sn
70%P _S MAX	0.91V _n	2873.92	209.60	1574.77	0.6*Q _{max}	≤5%Sn
80%P _S MAX	0.91V _n	3293.38	209.71	1606.45	0.6*Q _{max}	≤5%Sn
90%P _S MAX	0.91V _n	3700.01	209.80	1674.88	0.6*Q _{max}	≤5%Sn
100%P _S MAX	0.91V _n	4094.95	209.82	1688.82	0.6*Q _{max}	≤5%Sn
100%P _S MAX	0.90V _n	4109.00	207.66	2922.70	Q _{max}	≤5%Sn
10%P _S MAX	0.90V _n	417.78	206.86	2835.82	Q _{max}	≤5%Sn
≤5%P _S MAX	0.90V _n	161.23	206.67	155.23	k*Q _{max} (lock-out)	≤5%Sn

CEI 0-21			
Clause	Requirement - Test	Result - Remark	Verdict

Curve A.2 - Test for bidirectional EESS in DISCHARGE with $k = -0.1$

Setting Power[%]	Setting Voltage [V]	Output Power [W]	Voltage [V]	Reactive Power [Var]	Reactive Power expected [Var]	ΔQ
<20%P _S MAX	1.07Vn	742.17	246.05	-162.05	-k*Qmax	≤5%Sn
<20%P _S MAX	1.09Vn	743.17	250.55	-165.12	-k*Qmax	≤5%Sn
30%P _S MAX	1.09Vn	1237.02	250.62	-1715.77	-0.6*Qmax (lock-in) <i>within 10sec</i>	≤5%Sn
40%P _S MAX	1.09Vn	1648.26	250.67	-1728.16	-0.6*Qmax	≤5%Sn
50%P _S MAX	1.09Vn	2058.49	250.76	-1757.90	-0.6*Qmax	≤5%Sn
60%P _S MAX	1.09Vn	2466.43	250.83	-1782.12	-0.6*Qmax	≤5%Sn
70%P _S MAX	1.09Vn	2870.82	250.89	-1762.90	-0.6*Qmax	≤5%Sn
80%P _S MAX	1.09Vn	3288.32	250.96	-1791.41	-0.6*Qmax	≤5%Sn
90%P _S MAX	1.09Vn	3692.82	251.03	-1812.80	-0.6*Qmax	≤5%Sn
100%P _S MAX	1.09Vn	4086.54	251.12	-1828.29	-0.6*Qmax	≤5%Sn
100%P _S MAX	1.1Vn	4100.87	253.34	-2869.03	-Qmax	≤5%Sn
10%P _S MAX	1.1Vn	410.93	252.69	-2799.21	-Qmax	≤5%Sn
≤5%P _S MAX	1.1Vn	160.96	252.76	-190.56	-k*Qmax (lock-out)	≤5%Sn

Curve B.2 - Test for bidirectional EESS in DISCHARGE with $k = -0.1$

Setting Power[%]	Setting Voltage [V]	Output Power [W]	Voltage [V]	Reactive Power [Var]	Reactive Power expected [Var]	ΔQ
<20%P _S MAX	0.93Vn	738.02	213.45	-178.51	-k*Qmax	≤5%Sn
<20%P _S MAX	0.91Vn	740.55	208.92	-184.70	-k*Qmax	≤5%Sn
30%P _S MAX	0.91Vn	1235.23	209.06	1195.86	0.4*Qmax (lock-in) <i>within 10sec</i>	≤5%Sn
40%P _S MAX	0.91Vn	1651.51	209.17	1244.20	0.4*Qmax	≤5%Sn
50%P _S MAX	0.91Vn	2061.24	209.25	1262.80	0.4*Qmax	≤5%Sn
60%P _S MAX	0.91Vn	2470.54	209.34	1268.53	0.4*Qmax	≤5%Sn
70%P _S MAX	0.91Vn	2872.82	209.41	1273.86	0.4*Qmax	≤5%Sn
80%P _S MAX	0.91Vn	3291.33	209.51	1277.42	0.4*Qmax	≤5%Sn
90%P _S MAX	0.91Vn	3695.80	209.58	1284.22	0.4*Qmax	≤5%Sn
100%P _S MAX	0.91Vn	4089.75	209.64	1293.99	0.4*Qmax	≤5%Sn
100%P _S MAX	0.90Vn	4104.41	207.48	2533.18	0.9*Qmax	≤5%Sn
10%P _S MAX	0.90Vn	414.10	206.68	2470.02	0.9*Qmax	≤5%Sn
≤5%P _S MAX	0.90Vn	157.72	206.45	-193.03	-k*Qmax (lock-out)	≤5%Sn

CEI 0-21			
Clause	Requirement - Test	Result - Remark	Verdict

Curve A.1 - Test for bidirectional EESS in CHARGE with $k = +0.1$

Setting Power [%]	Setting Voltage [V]	Output Power [W]	Voltage [V]	Reactive Power [Var]	Reactive Power expected [Var]	ΔQ
<20%P _C MAX	1.07V _n	-729.51	245.90	205.51	k*Q _{max}	≤5%Sn
<20%P _C MAX	1.09V _n	-728.36	250.35	191.10	k*Q _{max}	≤5%Sn
30%P _C MAX	1.09V _n	-1220.15	250.48	-1179.38	-0.4*Q _{max} (lock-in) <i>within 10sec</i>	≤5%Sn
40%P _C MAX	1.09V _n	-1633.75	250.54	-1194.28	-0.4*Q _{max}	≤5%Sn
50%P _C MAX	1.09V _n	-2046.39	250.59	-1207.59	-0.4*Q _{max}	≤5%Sn
60%P _C MAX	1.09V _n	-2454.80	250.71	-1210.95	-0.4*Q _{max}	≤5%Sn
70%P _C MAX	1.09V _n	-2852.25	250.77	-1215.48	-0.4*Q _{max}	≤5%Sn
80%P _C MAX	1.09V _n	-3272.19	250.85	-1219.30	-0.4*Q _{max}	≤5%Sn
90%P _C MAX	1.09V _n	-3678.99	250.90	-1222.75	-0.4*Q _{max}	≤5%Sn
100%P _C MAX	1.09V _n	-4074.24	250.98	-1231.54	-0.4*Q _{max}	≤5%Sn
100%P _C MAX	1.1V _n	-4083.56	253.20	-2614.50	-0.9*Q _{max}	≤5%Sn
10%P _C MAX	1.1V _n	-399.18	252.56	-2577.66	-0.9*Q _{max}	≤5%Sn
≤5%P _C MAX	1.1V _n	-149.47	252.62	182.49	k*Q _{max} (lock-out)	≤5%Sn

Curve B.1 - Test for bidirectional EESS in CHARGE with $k = +0.1$

Setting Power [%]	Setting Voltage [V]	Output Power [W]	Voltage [V]	Reactive Power [Var]	Reactive Power expected [Var]	ΔQ
<20%P _C MAX	0.93V _n	-742.81	213.38	201.35	k*Q _{max}	≤5%Sn
<20%P _C MAX	0.91V _n	-747.41	208.93	206.19	k*Q _{max}	≤5%Sn
30%P _C MAX	0.91V _n	-1239.99	209.00	1720.76	0.6*Q _{max} (lock-in) <i>within 10sec</i>	≤5%Sn
40%P _C MAX	0.91V _n	-1655.43	209.08	1738.63	0.6*Q _{max}	≤5%Sn
50%P _C MAX	0.91V _n	-2066.64	209.18	1743.50	0.6*Q _{max}	≤5%Sn
60%P _C MAX	0.91V _n	-2476.59	209.26	1752.21	0.6*Q _{max}	≤5%Sn
70%P _C MAX	0.91V _n	-2873.66	209.34	1758.75	0.6*Q _{max}	≤5%Sn
80%P _C MAX	0.91V _n	-3296.22	209.41	1759.50	0.6*Q _{max}	≤5%Sn
90%P _C MAX	0.91V _n	-3701.80	209.49	1766.64	0.6*Q _{max}	≤5%Sn
100%P _C MAX	0.91V _n	-4096.73	209.57	1774.96	0.6*Q _{max}	≤5%Sn
100%P _C MAX	0.90V _n	-4112.58	207.39	2874.89	Q _{max}	≤5%Sn
10%P _C MAX	0.90V _n	-420.36	206.58	2841.21	Q _{max}	≤5%Sn
≤5%P _C MAX	0.90V _n	-164.55	206.38	301.50	k*Q _{max} (lock-out)	≤5%Sn

CEI 0-21			
Clause	Requirement - Test	Result - Remark	Verdict

Curve A.2 - Test for bidirectional EESS in CHARGE with $k = -0.1$						
Setting Power [%]	Setting Volatge [V]	Output Power [W]	Voltage [V]	Reactive Power [Var]	Reactive Power expected [Var]	ΔQ
<20%P _{C_{MAX}}	1.07V _n	-738.22	246.16	-197.06	-k*Q _{max}	≤5%Sn
<20%P _{C_{MAX}}	1.09V _n	-738.68	250.70	-201.46	-k*Q _{max}	≤5%Sn
30%P _{C_{MAX}}	1.09V _n	-1229.09	250.74	-1717.88	-0.9*Q _{max} (lock-in) <i>within 10sec</i>	≤5%Sn
40%P _{C_{MAX}}	1.09V _n	-1642.83	250.82	-1723.78	-0.6*Q _{max}	≤5%Sn
50%P _{C_{MAX}}	1.09V _n	-2053.45	250.88	-1729.82	-0.6*Q _{max}	≤5%Sn
60%P _{C_{MAX}}	1.09V _n	-2463.56	250.96	-1736.46	-0.6*Q _{max}	≤5%Sn
70%P _{C_{MAX}}	1.09V _n	-2861.94	251.04	-1743.01	-0.6*Q _{max}	≤5%Sn
80%P _{C_{MAX}}	1.09V _n	-3284.93	251.11	-1748.10	-0.6*Q _{max}	≤5%Sn
90%P _{C_{MAX}}	1.09V _n	-3688.44	251.19	-1759.79	-0.6*Q _{max}	≤5%Sn
100%P _{C_{MAX}}	1.09V _n	-4078.59	251.25	-1763.31	-0.6*Q _{max}	≤5%Sn
100%P _{C_{MAX}}	1.1V _n	-4093.45	253.47	-2878.01	-Q _{max}	≤5%Sn
10%P _{C_{MAX}}	1.1V _n	-407.48	252.83	-2876.91	-Q _{max}	≤5%Sn
≤5%P _{C_{MAX}}	1.1V _n	-157.36	252.90	-226.78	-k*Q _{max} (lock-out)	≤5%Sn
Curve B.2 - Test for bidirectional EESS in CHARGE with $k = -0.1$						
Setting Power [%]	Setting Volatge [V]	Output Power [W]	Voltage [V]	Reactive Power [Var]	Reactive Power expected [Var]	ΔQ
<20%P _{C_{MAX}}	0.93V _n	-750.39	213.78	-205.48	-k*Q _{max}	≤5%Sn
<20%P _{C_{MAX}}	0.91V _n	-753.21	209.26	-194.59	-k*Q _{max}	≤5%Sn
30%P _{C_{MAX}}	0.91V _n	-1251.26	209.38	1189.13	0.4*Q _{max} (lock-in) <i>within 10sec</i>	≤5%Sn
40%P _{C_{MAX}}	0.91V _n	-1664.88	209.51	1196.00	0.4*Q _{max}	≤5%Sn
50%P _{C_{MAX}}	0.91V _n	-2070.60	209.59	1202.36	0.4*Q _{max}	≤5%Sn
60%P _{C_{MAX}}	0.91V _n	-2480.86	209.69	1208.92	0.4*Q _{max}	≤5%Sn
70%P _{C_{MAX}}	0.91V _n	-2882.29	209.76	1216.24	0.4*Q _{max}	≤5%Sn
80%P _{C_{MAX}}	0.91V _n	-3303.65	209.85	1228.86	0.4*Q _{max}	≤5%Sn
90%P _{C_{MAX}}	0.91V _n	-3707.24	209.92	1235.05	0.4*Q _{max}	≤5%Sn
100%P _{C_{MAX}}	0.91V _n	-4116.29	209.96	1263.11	0.4*Q _{max}	≤5%Sn
100%P _{C_{MAX}}	0.90V _n	-4115.34	207.81	2645.78	0.9*Q _{max}	≤5%Sn
10%P _{C_{MAX}}	0.90V _n	-426.04	207.00	2610.97	0.9*Q _{max}	≤5%Sn
≤5%P _{C_{MAX}}	0.90V _n	-171.00	206.79	-179.75	-k*Q _{max} (lock-out)	≤5%Sn

CEI 0-21

Clause	Requirement - Test	Result - Remark	Verdict
--------	--------------------	-----------------	---------

Bbis.7.1	TABLE: Active power limitation for voltage values near to 110 % U_n				P	
Model	VT-6607106+16Battery					
$P_{SMAX} = 4096_W$						
$P_{CMAX} = 4096W$						
Set point		Activation threshold U_1		Deactivation threshold U_2		
U/ U_n		110%		112%		
P/ P_n		100%		20%		
Step	Set voltage [V/ V_n]	Voltage [V]	Measured power [W]	Measured power [%]	Limit	Result
1	1,08	248.83	4093.64	99.94	100%	P
2	1,12	257.66	-3450.00	-84.23	One-way: $P < 20\%P_{SMAX}$ Biaxially: $> 80\%P_{CMAX}$	P
3	1,08	248.68	4110.00	100.34	100%	P

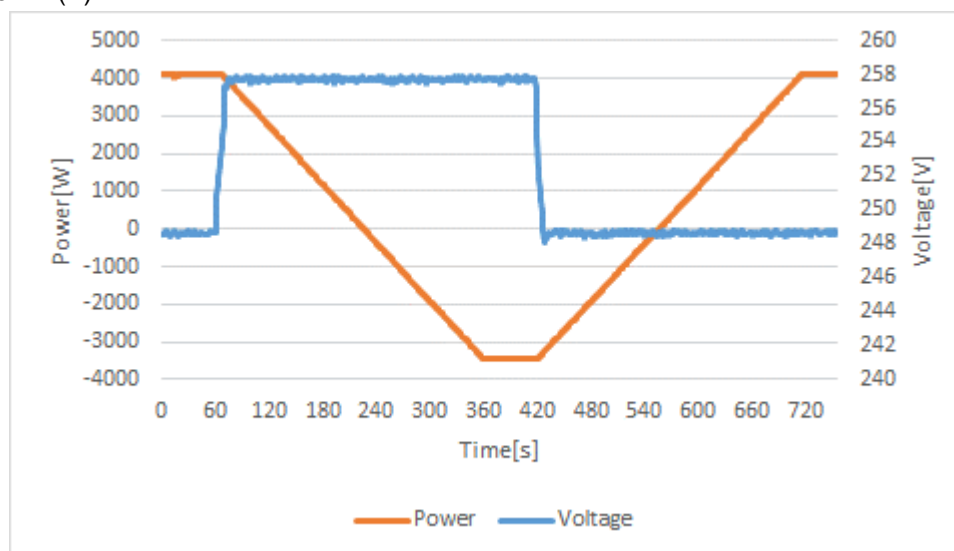
Graph curve $P=f(V)$:

CEI 0-21			
Clause	Requirement - Test	Result - Remark	Verdict

Bbis.7.1	TABLE: Active power limitation for voltage values near to 110 % U _n				P	
Model	VT-6607106+1Battery					
P _{SMAX} =4096W						
P _{CMAX} =4096W						
Set point		Activation threshold U ₁		Deactivation threshold U ₂		
U/U _n		110%		112%		
P/P _n		100%		20%		
Step	Set voltage [V/V _n]	Voltage [V]	Measured power [W]	Measured power [%]	Limit	Result
1	1,08	248.83	4084.50	99.72	100%	P
2	1,12	257.67	-3463.00	-84.55	One-way: P <20%P _{SMAX} Biaxially: >80%P _{CMAX}	P
3	1,08	248.70	4121.00	100.61	100%	P

Graph curve P=f(V):

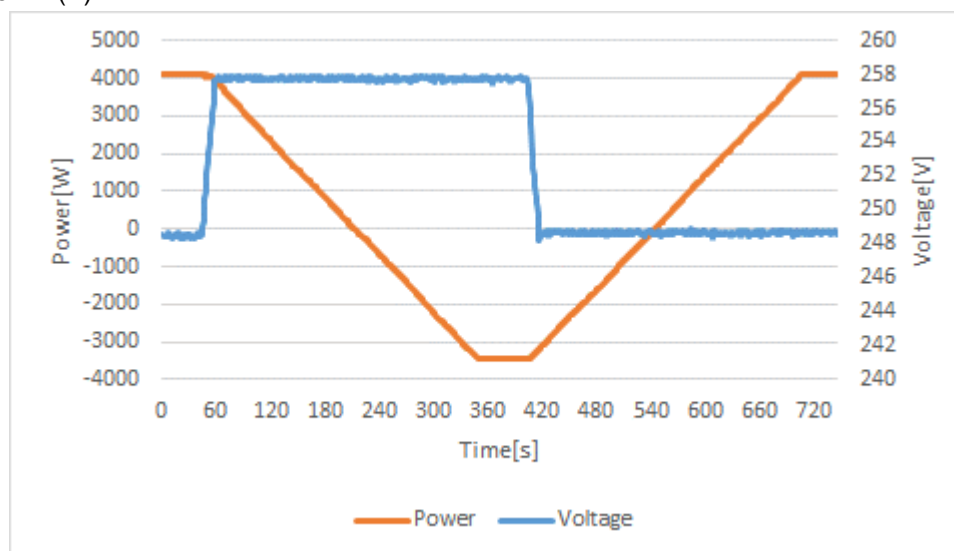

CEI 0-21			
Clause	Requirement - Test	Result - Remark	Verdict

Bbis.7.1	TABLE: Active power limitation for voltage values near to 110 % U_n				P	
Model	VT-6607100+1Battery					
$P_{SMAX} = 1000W$						
$P_{CMAX} = 1000W$						
Set point		Activation threshold U_1		Deactivation threshold U_2		
U/ U_n		110%		112%		
P/ P_n		100%		20%		
Step	Set voltage [V/ V_n]	Voltage [V]	Measured power [W]	Measured power [%]	Limit	Result
1	1,08	248.76	998.64	99.86	100%	P
2	1,12	257.60	-825.00	-82.50	One-way: $P < 20\%P_{SMAX}$ Biaxially: $> 80\%P_{CMAX}$	P
3	1,08	248.58	1016.00	101.60	100%	P

Graph curve $P=f(V)$:

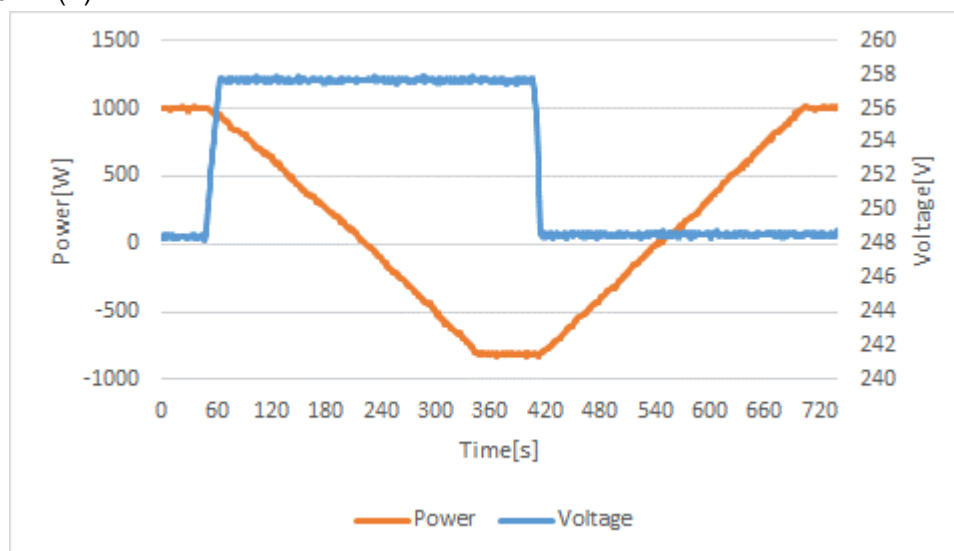

CEI 0-21

Clause	Requirement - Test	Result - Remark	Verdict
--------	--------------------	-----------------	---------

Bbis.7.2	TABLE: Verification of automatic reduction of active power in the presence of overfrequency transients on the network	P
-----------------	--	----------

Model VT-6607106+16Battery

Activation settings.....: Settable delay from 0s to 1s with step of 50ms (default value: no intentional delay)

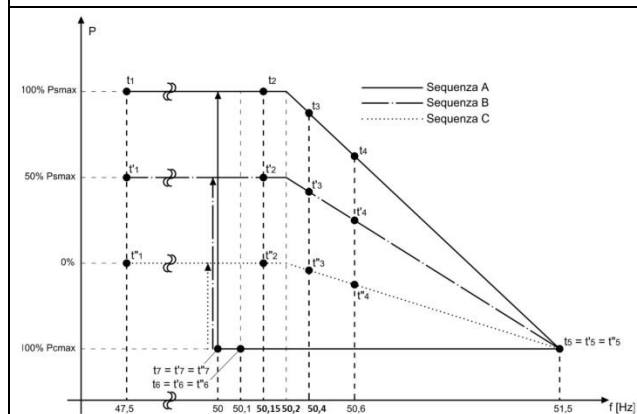

Figure 68 - Active power limitation curves for bidirectional converters

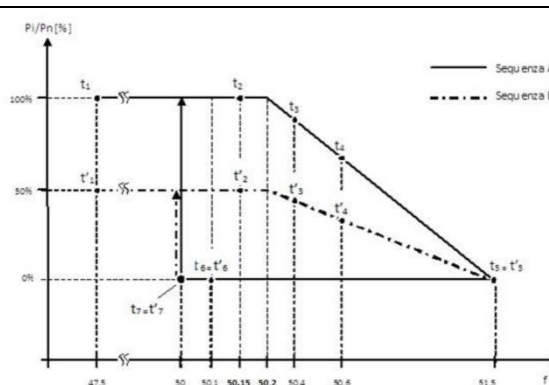

Figure 69 - Active power limitation curves for unidirectional converters

Supplementary information:

- bring all the parameters of the storage system under test to their respective normal operating values, such that the AC power delivered at the output is equal to the maximum AC power that can be delivered for sequence A, i.e. respectively at 50% and 0% in the case of the sequences B and C; energy equal to 80% of the useful capacity, CUS, must be stored in the storage system;
- perform the measurements on 7 points (the frequency value must have an uncertainty of maximum ± 10 mHz) temporally consequent to each other:
 1. $f = 47,51$ Hz (t_1 for sequence A, t'_1 for sequence B, t''_1 for sequence C);
 2. $f = 50$ Hz + 0,15 Hz (t_2 for sequence A, t'_2 for sequence B, t''_2 for sequence C);
 3. $f = 50$ Hz + 0,40 Hz (t_3 for sequence A, t'_3 for sequence B, t''_3 for sequence C);
 4. $f = 50$ Hz + 0,60 Hz (t_4 for sequence A, t'_4 for sequence B, t''_4 for sequence C);
 5. $f = 50$ Hz + 1,49 Hz (t_5 for sequence A, t'_5 for sequence B, t''_5 for sequence C);
 6. $f = 50$ Hz + 0,11 Hz (t_6 for sequence A, t'_6 for sequence B, t''_6 for sequence C);
 7. $f = 50$ Hz (t_7 for sequence A, t'_7 for sequence B, t''_7 for sequence C). The frequency is reported to the nominal value for the verification of the conditions of gradual restoration of the maximum supply (sequence A), that is to say at 50% or 0% of the maximum available power (respectively, sequence B and C).

* The sequence C is applicable only for bi-directional converters.

CEI 0-21			
Clause	Requirement - Test	Result - Remark	Verdict

Model	VT-6607106+16Battery					
Sequence A						
Step No.	Set output power [%]	Frequency [Hz]	Expected power value [W]	Actual power values [W]	Limits	Graph point
1	100	47.51	4096	4092	± 2.5% Pn	t ₁
2	100	50.15	4096	4093	± 2.5% Pn	t ₂
3	100	50.40	2836	2783	± 2.5% Pn	t ₃
4	100	50.60	1575	1559	± 2.5% Pn	t ₄
5	100	51.49	-4033	-3900	± 2.5% Pn	t ₅
6	100	50.10	-4033	-4044	± 2.5% Pn	t ₆
7	100	50.00	4096	4097	Pn	t ₇
Sequence B						
Step No.	Set output power [%]	Frequency [Hz]	Expected power value [W]	Actual power values [W]	Limits	Graph point
1	50	47.51	2048	2047	± 2.5% Pn	t' ₁
2	50	50.15	2048	2046	± 2.5% Pn	t' ₂
3	50	50.40	1103	1085	± 2.5% Pn	t' ₃
4	50	50.60	158	155	± 2.5% Pn	t' ₄
5	50	51.49	-4049	-3955	± 2.5% Pn	t' ₅
6	50	50.10	-4049	-4052	± 2.5% Pn	t' ₆
7	50	50.00	2048	2035	50% Pn	t' ₇
Sequence C						
Step No.	Set output power [%]	Frequency [Hz]	Expected power value [W]	Actual power values [W]	Limits	Graph point
1	0	47.51	0	-9	± 2.5% Pn	t'' ₁
2	0	50.15	0	-9	± 2.5% Pn	t'' ₂
3	0	50.40	-630	-621	± 2.5% Pn	t'' ₃
4	0	50.60	-1260	-1252	± 2.5% Pn	t'' ₄
5	0	51.49	-4064	-4034	± 2.5% Pn	t'' ₅
6	0	50.10	-4064	-4065	± 2.5% Pn	t'' ₆
7	0	50.00	0	-7	0% Pn	t'' ₇

CEI 0-21			
Clause	Requirement - Test	Result - Remark	Verdict

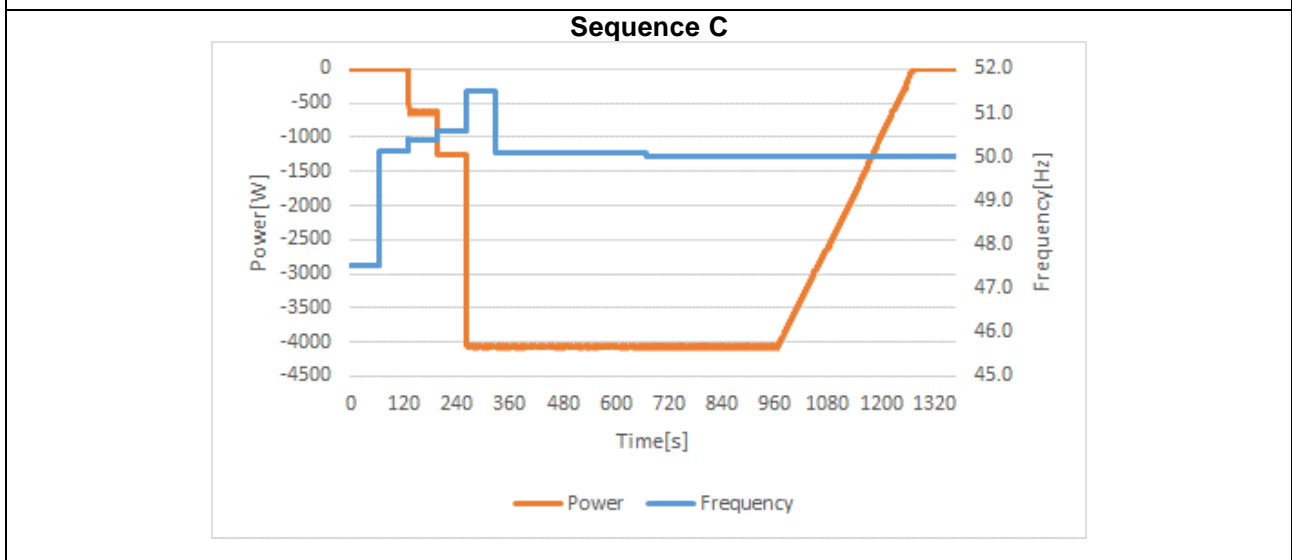
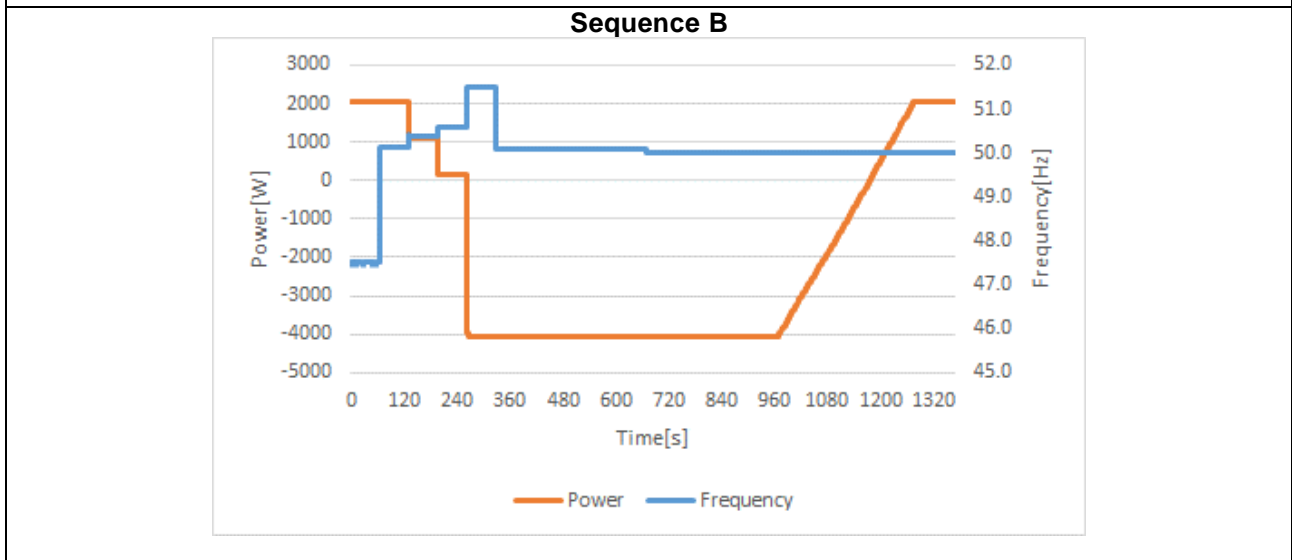
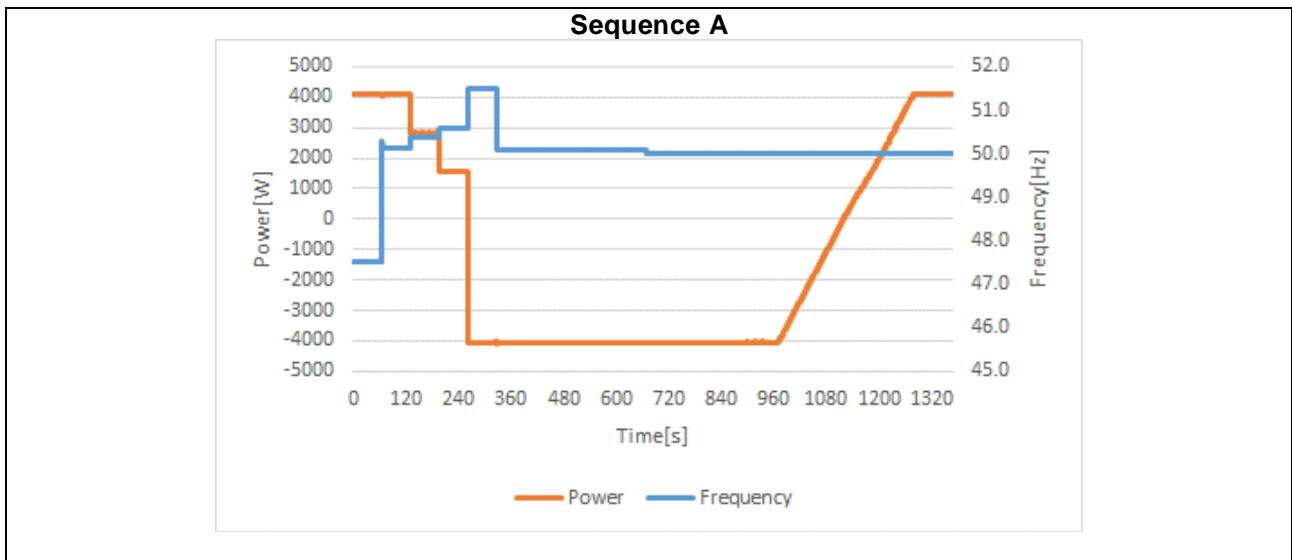

CEI 0-21			
Clause	Requirement - Test	Result - Remark	Verdict

Model	VT-6607106+1Battery					
Sequence A						
Step No.	Set output power [%]	Frequency [Hz]	Expected power value [W]	Actual power values [W]	Limits	Graph point
1	100	47.51	4096	4100	± 2.5% Pn	t ₁
2	100	50.15	4096	4100	± 2.5% Pn	t ₂
3	100	50.40	2836	2816	± 2.5% Pn	t ₃
4	100	50.60	1575	1582	± 2.5% Pn	t ₄
5	100	51.49	-4033	-3934	± 2.5% Pn	t ₅
6	100	50.10	-4033	-4045	± 2.5% Pn	t ₆
7	100	50.00	4096	4131	Pn	t ₇
Sequence B						
Step No.	Set output power [%]	Frequency [Hz]	Expected power value [W]	Actual power values [W]	Limits	Graph point
1	50	47.51	2048	2041	± 2.5% Pn	t' ₁
2	50	50.15	2048	2041	± 2.5% Pn	t' ₂
3	50	50.40	1103	1089	± 2.5% Pn	t' ₃
4	50	50.60	158	139	± 2.5% Pn	t' ₄
5	50	51.49	-4049	-3955	± 2.5% Pn	t' ₅
6	50	50.10	-4049	-4056	± 2.5% Pn	t' ₆
7	50	50.00	2048	2052	50% Pn	t' ₇
Sequence C						
Step No.	Set output power [%]	Frequency [Hz]	Expected power value [W]	Actual power values [W]	Limits	Graph point
1	0	47.51	0	-9	± 2.5% Pn	t'' ₁
2	0	50.15	0	1	± 2.5% Pn	t'' ₂
3	0	50.40	-630	-623	± 2.5% Pn	t'' ₃
4	0	50.60	-1260	-1270	± 2.5% Pn	t'' ₄
5	0	51.49	-4064	-4023	± 2.5% Pn	t'' ₅
6	0	50.10	-4064	-4054	± 2.5% Pn	t'' ₆
7	0	50.00	0	12	0% Pn	t'' ₇

CEI 0-21			
Clause	Requirement - Test	Result - Remark	Verdict

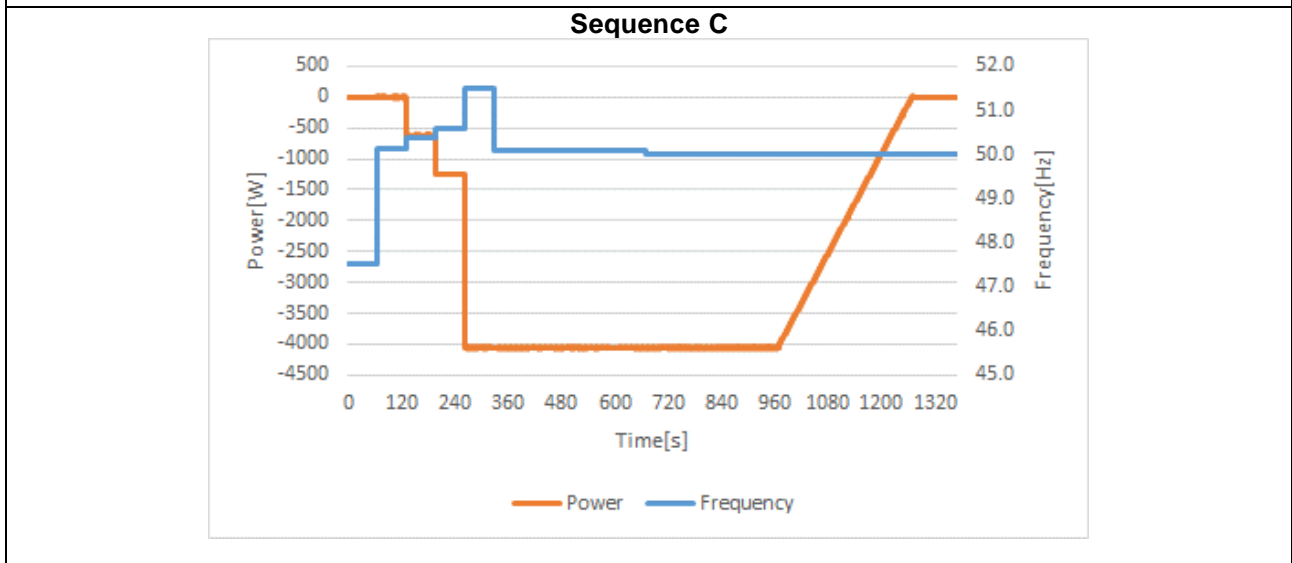
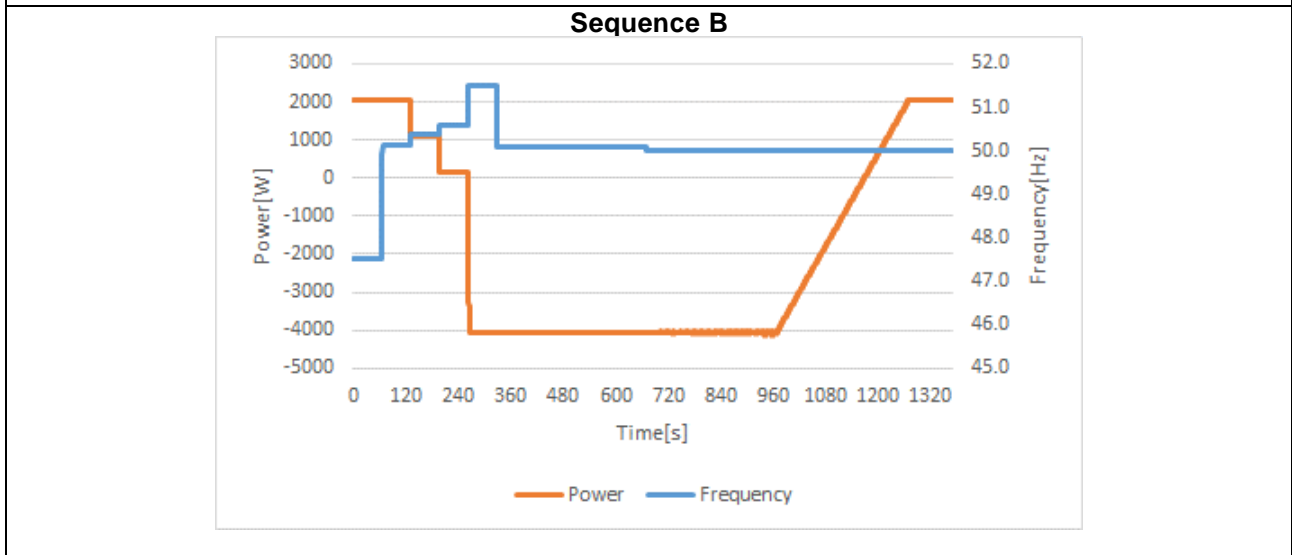
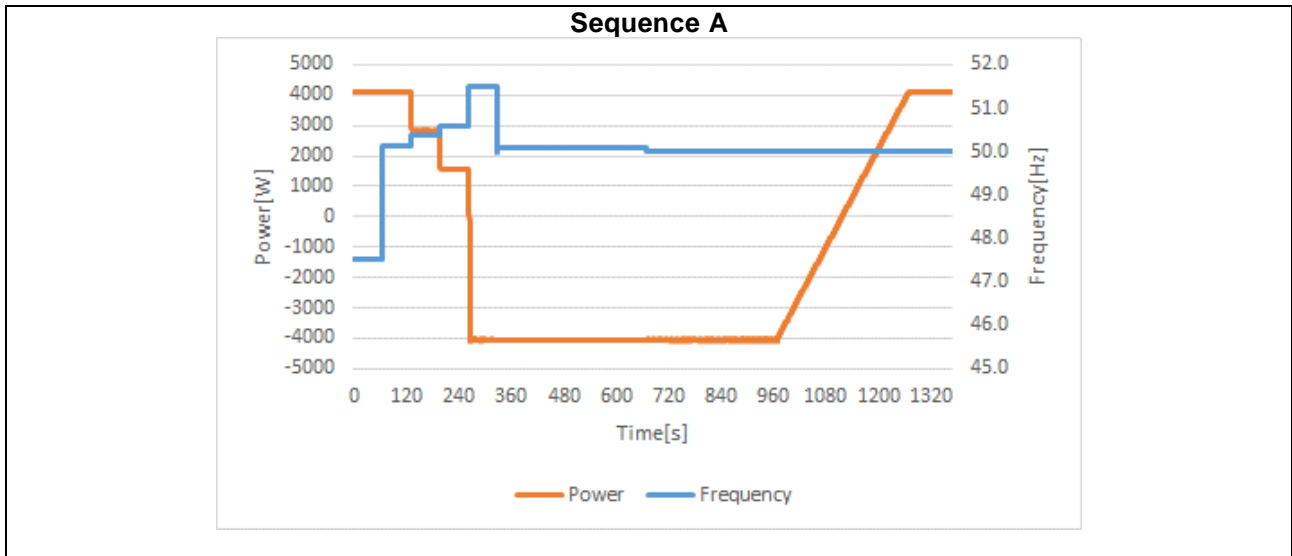

CEI 0-21			
Clause	Requirement - Test	Result - Remark	Verdict

Model	VT-6607100+1Battery					
Sequence A						
Step No.	Set output power [%]	Frequency [Hz]	Expected power value [W]	Actual power values [W]	Limits	Graph point
1	100	47.51	1000	990	$\pm 2.5\% P_n$	t ₁
2	100	50.15	1000	988	$\pm 2.5\% P_n$	t ₂
3	100	50.40	692	685	$\pm 2.5\% P_n$	t ₃
4	100	50.60	385	377	$\pm 2.5\% P_n$	t ₄
5	100	51.49	-985	-968	$\pm 2.5\% P_n$	t ₅
6	100	50.10	-985	-988	$\pm 2.5\% P_n$	t ₆
7	100	50.00	1000	996	P _n	t ₇
Sequence B						
Step No.	Set output power [%]	Frequency [Hz]	Expected power value [W]	Actual power values [W]	Limits	Graph point
1	50	47.51	500	500	$\pm 2.5\% P_n$	t' ₁
2	50	50.15	500	499	$\pm 2.5\% P_n$	t' ₂
3	50	50.40	269	274	$\pm 2.5\% P_n$	t' ₃
4	50	50.60	38	39	$\pm 2.5\% P_n$	t' ₄
5	50	51.49	-988	-963	$\pm 2.5\% P_n$	t' ₅
6	50	50.10	-988	-977	$\pm 2.5\% P_n$	t' ₆
7	50	50.00	500	504	50% P _n	t' ₇
Sequence C						
Step No.	Set output power [%]	Frequency [Hz]	Expected power value [W]	Actual power values [W]	Limits	Graph point
1	0	47.51	0	-3	$\pm 2.5\% P_n$	t'' ₁
2	0	50.15	0	4	$\pm 2.5\% P_n$	t'' ₂
3	0	50.40	-154	-146	$\pm 2.5\% P_n$	t'' ₃
4	0	50.60	-308	-301	$\pm 2.5\% P_n$	t'' ₄
5	0	51.49	-992	-975	$\pm 2.5\% P_n$	t'' ₅
6	0	50.10	-992	-984	$\pm 2.5\% P_n$	t'' ₆
7	0	50.00	0	16	0% P _n	t'' ₇

CEI 0-21			
Clause	Requirement - Test	Result - Remark	Verdict

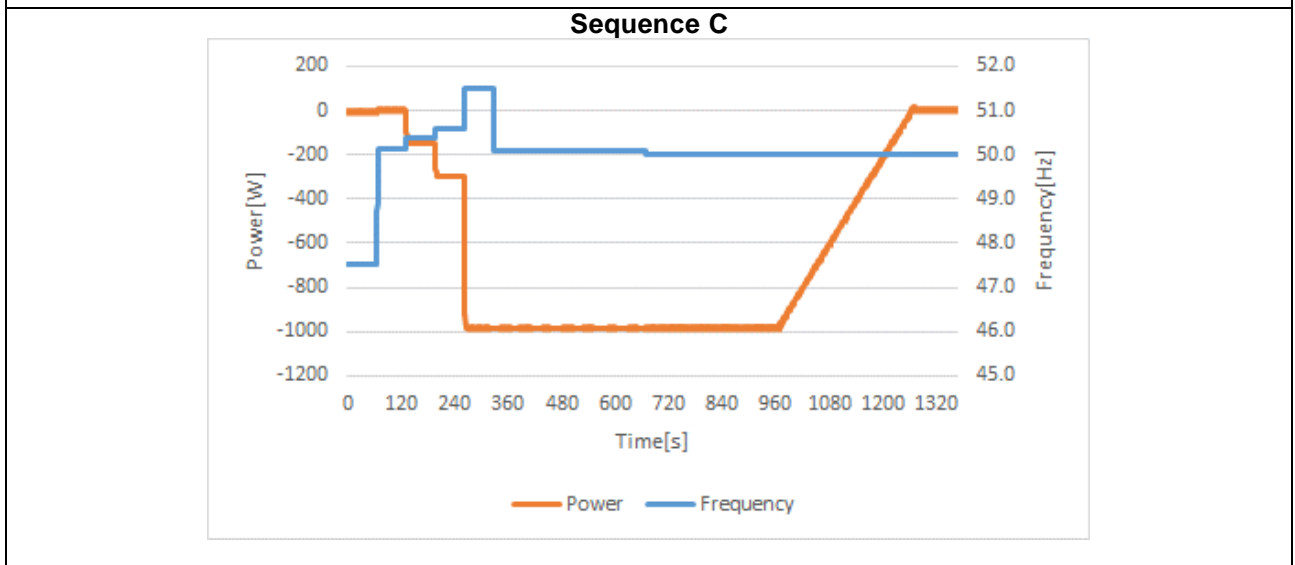
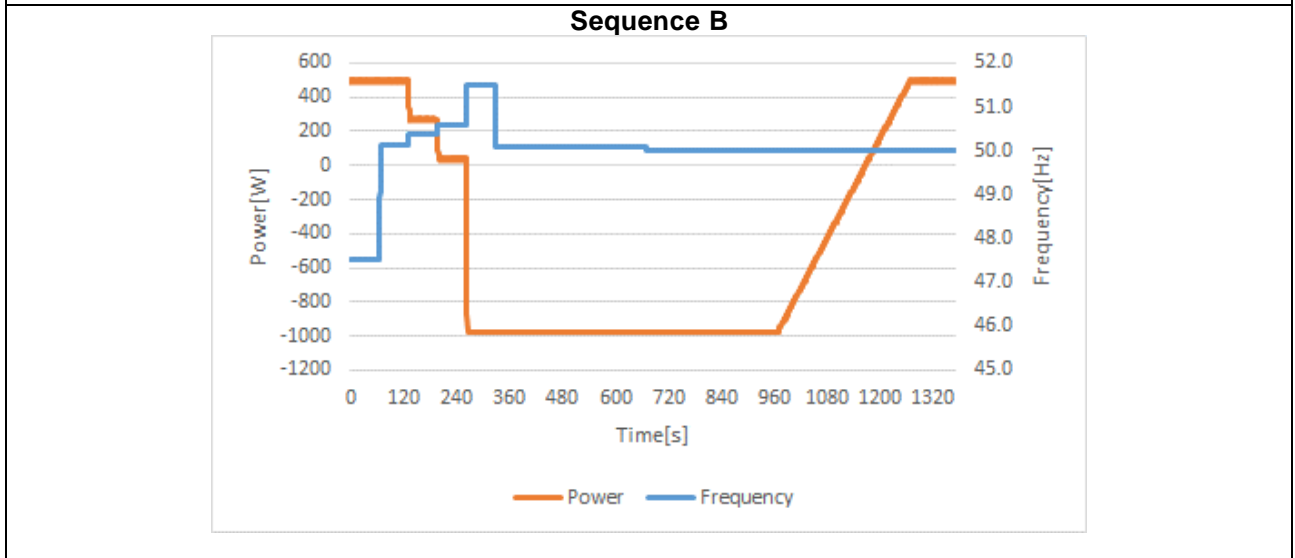
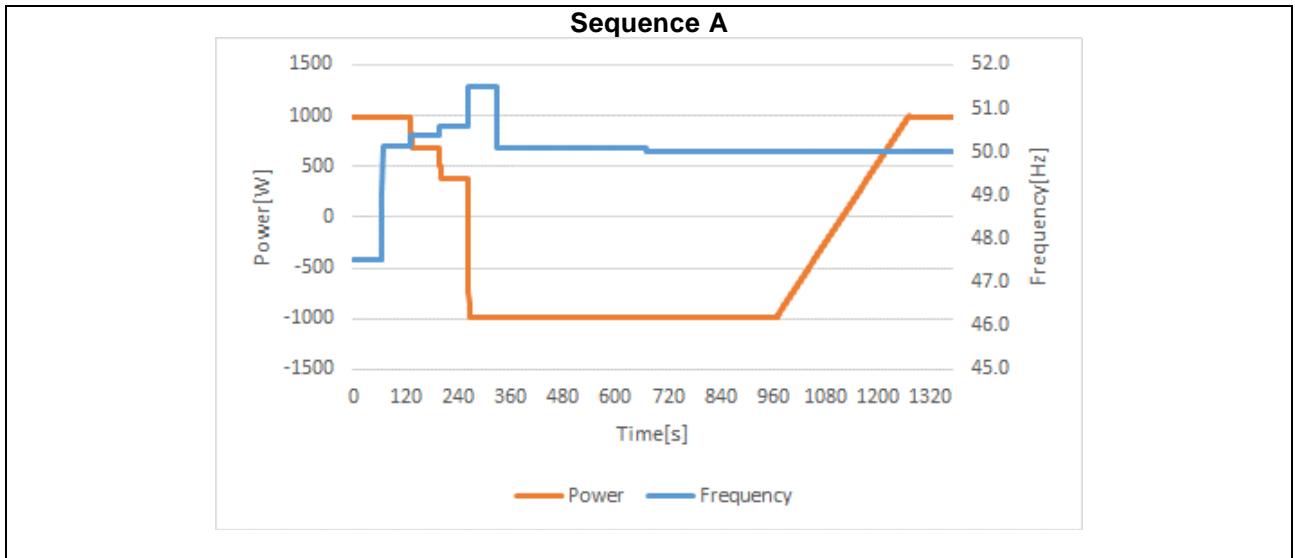

CEI 0-21			
Clause	Requirement - Test	Result - Remark	Verdict

Bbis.7.3	TABLE: Verification of the automatic increase of active power in the presence of underfrequency transients on the network	P
-----------------	--	----------

Activation settings.....: Settable delay from 0s to 1s with step of 50ms (default value: no intentional delay)

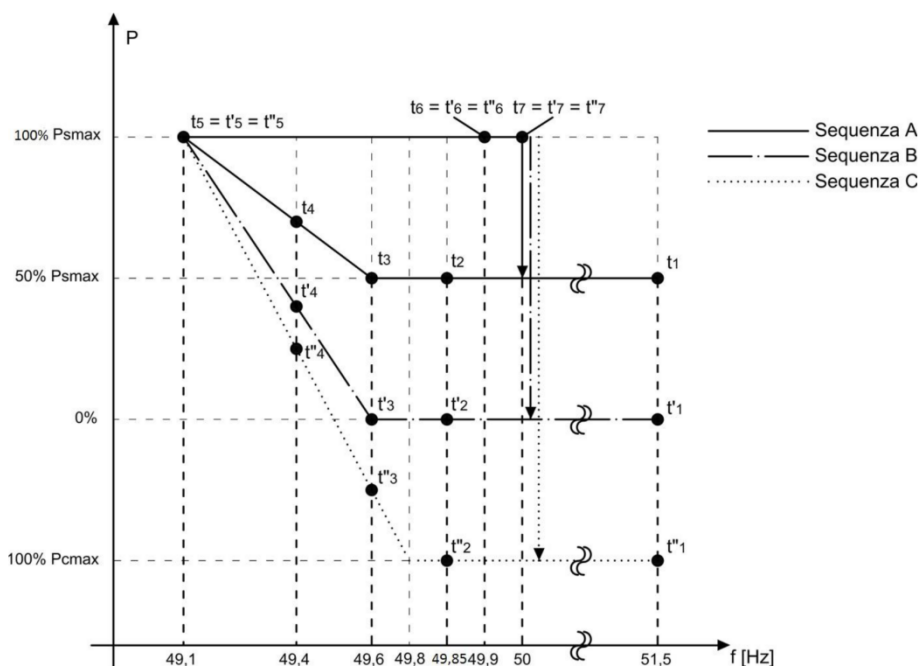

Figure 70 - Active power limitation curves

Bbis.7.4 Verification of the regulation of the active power on an external command from the DSO

Supplementary information:

The function of power derating under over-frequency was disabled for this test.

- bring all the parameters of the storage system under test to their respective normal operating values, such that the AC power delivered at the output is respectively equal, for sequences A and B, to 50% and 0% of $P_{S\text{MAX}}$ (or $P_{N\text{INIV}}$ for integrated storage systems) and, for sequence C, 100% of the $P_{C\text{MAX}}$; energy equal to 20% of the useful capacity, CUS, must be stored in the storage system;
- perform the measurements on 7 points (the frequency value must have an uncertainty of maximum ± 10 mHz) temporally consequent to each other:
 1. $f = 51,49$ Hz (t_1 for sequence A, t'_1 for sequence B, t''_1 for sequence C);
 2. $f = 50$ Hz - 0,15 Hz (t_2 for sequence A, t'_2 for sequence B, t''_2 for sequence C);
 3. $f = 50$ Hz - 0,40 Hz (t_3 for sequence A, t'_3 for sequence B, t''_3 for sequence C);
 4. $f = 50$ Hz - 0,60 Hz (t_4 for sequence A, t'_4 for sequence B, t''_4 for sequence C);
 5. $f = 50$ Hz - 0,89 Hz (t_5 for sequence A, t'_5 for sequence B, t''_5 for sequence C);
 6. $f = 50$ Hz - 0,11 Hz (t_6 for sequence A, t'_6 for sequence B, t''_6 for sequence C);
 7. $f = 50$ Hz (t_7 for the sequence A, t'_7 for the sequence B, t''_7 for the sequence C). The frequency is reported at the nominal value for the verification of the gradual recovery conditions, for sequences A and B, respectively of 50% and 0% of the $P_{S\text{MAX}}$ (or of $P_{N\text{INIV}}$ for integrated storage systems) and, for sequence C, 100% of the $P_{C\text{MAX}}$.

CEI 0-21			
Clause	Requirement - Test	Result - Remark	Verdict

Model	VT-6607106+16Battery					
Sequence A						
Step No.	Set output power [%]	Frequency [Hz]	Expected power value [W]	Actual power values [W]	Limits	Graph point
1	50	51.49	2048	2056	$\pm 2.5\%$ Sn	t ₁
2	50	49.85	2048	2056	$\pm 2.5\%$ Sn	t ₂
3	50	49.60	2048	2063	$\pm 2.5\%$ Sn	t ₃
4	50	49.40	2867	2878	$\pm 2.5\%$ Sn	t ₄
5	50	49.10	4096	4097	$\pm 2.5\%$ Sn	t ₅
6	50	49.89	4096	4108	$\pm 2.5\%$ Sn	t ₆
7	50	50.00	2048	2047	$\pm 2.5\%$ Sn	t ₇
Sequence B						
Step No.	Set output power [%]	Frequency [Hz]	Expected power value [W]	Actual power values [W]	Limits	Graph point
1	0	51.49	0	3	$\pm 2.5\%$ Sn	t' ₁
2	0	49.85	0	-5	$\pm 2.5\%$ Sn	t' ₂
3	0	49.60	0	12	$\pm 2.5\%$ Sn	t' ₃
4	0	49.40	1638	1659	$\pm 2.5\%$ Sn	t' ₄
5	0	49.10	4096	4083	$\pm 2.5\%$ Sn	t' ₅
6	0	49.89	4096	4105	$\pm 2.5\%$ Sn	t' ₆
7	0	50.00	0	-3	$\pm 2.5\%$ Sn	t' ₇
Sequence C						
Step No.	Set output power [%]	Frequency [Hz]	Expected power value [W]	Actual power values [W]	Limits	Graph point
1	100% P _C MAX	51.49	-4096	-4102	$\pm 2.5\%$ Sn	t'' ₁
2	100% P _C MAX	49.85	-4096	-4097	$\pm 2.5\%$ Sn	t'' ₂
3	100% P _C MAX	49.60	-1755	-1750	$\pm 2.5\%$ Sn	t'' ₃
4	100% P _C MAX	49.40	585	589	$\pm 2.5\%$ Sn	t'' ₄
5	100% P _C MAX	49.10	4096	4072	$\pm 2.5\%$ Sn	t'' ₅
6	100% P _C MAX	49.89	4096	4101	$\pm 2.5\%$ Sn	t'' ₆
7	100% P _C MAX	50.00	-4096	-4111	$\pm 2.5\%$ Sn	t'' ₇

CEI 0-21			
Clause	Requirement - Test	Result - Remark	Verdict

Graph Active power regulation in coincidence with transitory on the transmission grid
Sequence A

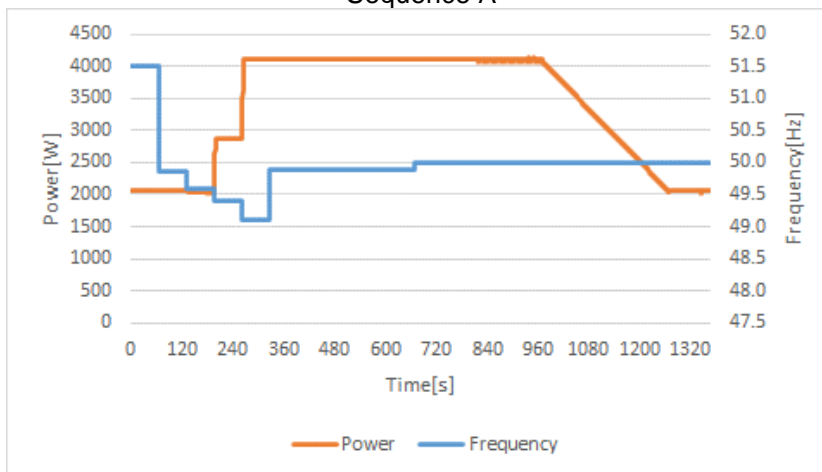

Graph Active power regulation in coincidence with transitory on the transmission grid
Sequence B

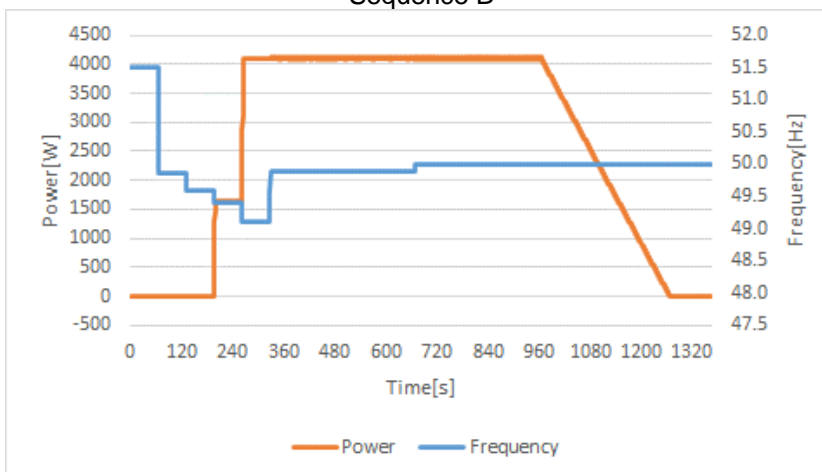

Graph Active power regulation in coincidence with transitory on the transmission grid
Sequence C

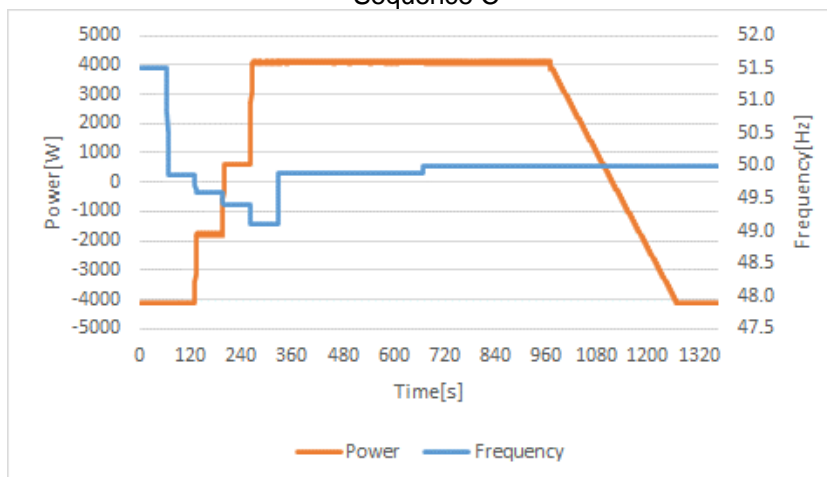

CEI 0-21			
Clause	Requirement - Test	Result - Remark	Verdict

Model	VT-6607106+1Battery					
Sequence A						
Step No.	Set output power [%]	Frequency [Hz]	Expected power value [W]	Actual power values [W]	Limits	Graph point
1	50	51.49	2048	2044	$\pm 2.5\%$ Sn	t ₁
2	50	49.85	2048	2044	$\pm 2.5\%$ Sn	t ₂
3	50	49.60	2048	2051	$\pm 2.5\%$ Sn	t ₃
4	50	49.40	2867	2877	$\pm 2.5\%$ Sn	t ₄
5	50	49.10	4096	4091	$\pm 2.5\%$ Sn	t ₅
6	50	49.89	4096	4101	$\pm 2.5\%$ Sn	t ₆
7	50	50.00	2048	2035	$\pm 2.5\%$ Sn	t ₇
Sequence B						
Step No.	Set output power [%]	Frequency [Hz]	Expected power value [W]	Actual power values [W]	Limits	Graph point
1	0	51.49	0	24	$\pm 2.5\%$ Sn	t' ₁
2	0	49.85	0	-15	$\pm 2.5\%$ Sn	t' ₂
3	0	49.60	0	-1	$\pm 2.5\%$ Sn	t' ₃
4	0	49.40	1638	1649	$\pm 2.5\%$ Sn	t' ₄
5	0	49.10	4096	4086	$\pm 2.5\%$ Sn	t' ₅
6	0	49.89	4096	4099	$\pm 2.5\%$ Sn	t' ₆
7	0	50.00	0	-18	$\pm 2.5\%$ Sn	t' ₇
Sequence C						
Step No.	Set output power [%]	Frequency [Hz]	Expected power value [W]	Actual power values [W]	Limits	Graph point
1	100% P _C MAX	51.49	-4096	-4095	$\pm 2.5\%$ Sn	t'' ₁
2	100% P _C MAX	49.85	-4096	-4091	$\pm 2.5\%$ Sn	t'' ₂
3	100% P _C MAX	49.60	-1755	-1742	$\pm 2.5\%$ Sn	t'' ₃
4	100% P _C MAX	49.40	585	597	$\pm 2.5\%$ Sn	t'' ₄
5	100% P _C MAX	49.10	4096	4079	$\pm 2.5\%$ Sn	t'' ₅
6	100% P _C MAX	49.89	4096	4108	$\pm 2.5\%$ Sn	t'' ₆
7	100% P _C MAX	50.00	-4096	-4108	$\pm 2.5\%$ Sn	t'' ₇

CEI 0-21			
Clause	Requirement - Test	Result - Remark	Verdict

Graph Active power regulation in coincidence with transitory on the transmission grid Sequence A

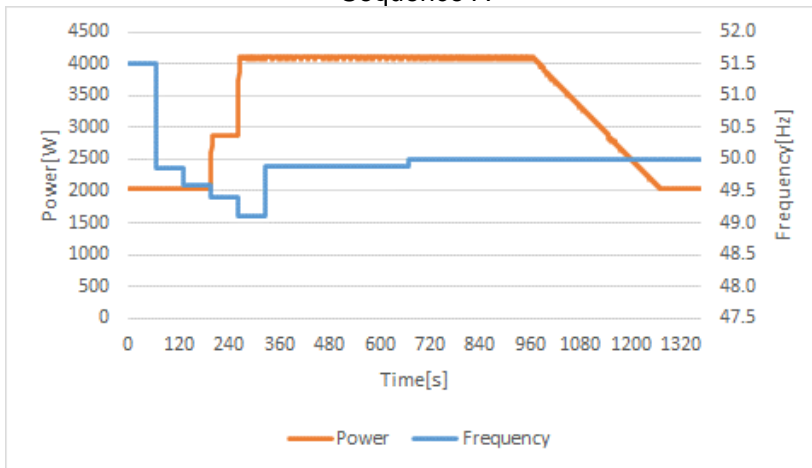

Graph Active power regulation in coincidence with transitory on the transmission grid Sequence B

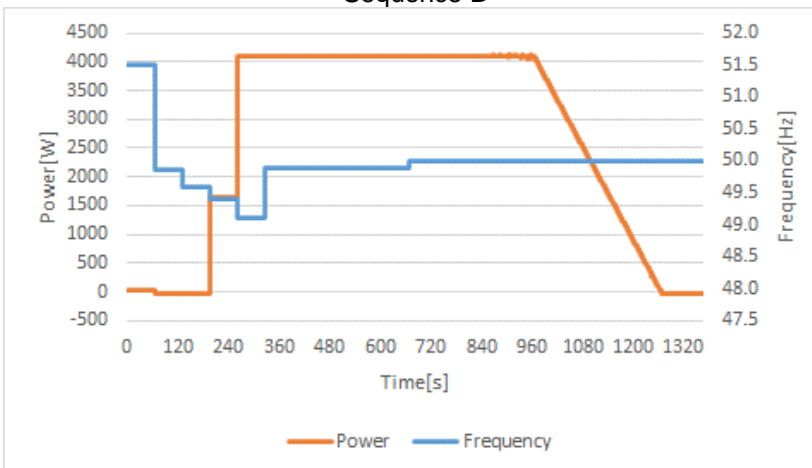

Graph Active power regulation in coincidence with transitory on the transmission grid Sequence C

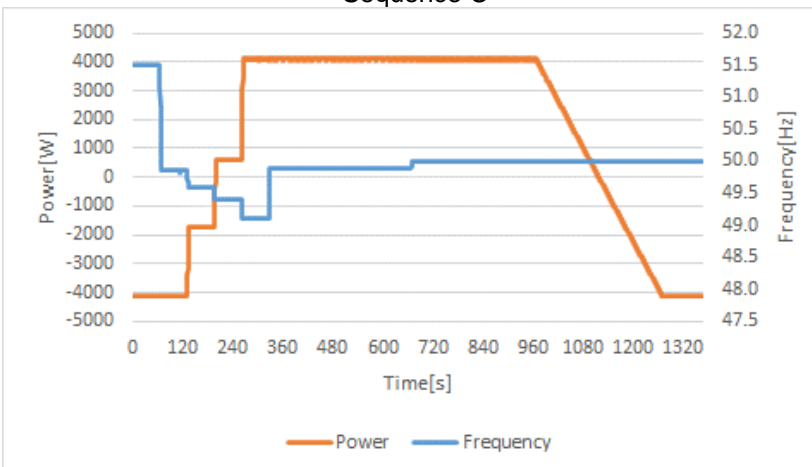

CEI 0-21			
Clause	Requirement - Test	Result - Remark	Verdict

Model	VT-6607100+1Battery					
Sequence A						
Step No.	Set output power [%]	Frequency [Hz]	Expected power value [W]	Actual power values [W]	Limits	Graph point
1	50	51.49	500	506	$\pm 2.5\%$ Sn	t ₁
2	50	49.85	500	506	$\pm 2.5\%$ Sn	t ₂
3	50	49.60	500	508	$\pm 2.5\%$ Sn	t ₃
4	50	49.40	700	702	$\pm 2.5\%$ Sn	t ₄
5	50	49.10	1000	1005	$\pm 2.5\%$ Sn	t ₅
6	50	49.89	1000	1007	$\pm 2.5\%$ Sn	t ₆
7	50	50.00	500	504	$\pm 2.5\%$ Sn	t ₇
Sequence B						
Step No.	Set output power [%]	Frequency [Hz]	Expected power value [W]	Actual power values [W]	Limits	Graph point
1	0	51.49	0	11	$\pm 2.5\%$ Sn	t' ₁
2	0	49.85	0	5	$\pm 2.5\%$ Sn	t' ₂
3	0	49.60	0	8	$\pm 2.5\%$ Sn	t' ₃
4	0	49.40	400	393	$\pm 2.5\%$ Sn	t' ₄
5	0	49.10	1000	987	$\pm 2.5\%$ Sn	t' ₅
6	0	49.89	1000	992	$\pm 2.5\%$ Sn	t' ₆
7	0	50.00	0	-13	$\pm 2.5\%$ Sn	t' ₇
Sequence C						
Step No.	Set output power [%]	Frequency [Hz]	Expected power value [W]	Actual power values [W]	Limits	Graph point
1	100% P _C MAX	51.49	-1000	-990	$\pm 2.5\%$ Sn	t'' ₁
2	100% P _C MAX	49.85	-1000	-989	$\pm 2.5\%$ Sn	t'' ₂
3	100% P _C MAX	49.60	-429	-420	$\pm 2.5\%$ Sn	t'' ₃
4	100% P _C MAX	49.40	143	147	$\pm 2.5\%$ Sn	t'' ₄
5	100% P _C MAX	49.10	1000	995	$\pm 2.5\%$ Sn	t'' ₅
6	100% P _C MAX	49.89	1000	1002	$\pm 2.5\%$ Sn	t'' ₆
7	100% P _C MAX	50.00	-1000	-996	$\pm 2.5\%$ Sn	t'' ₇

CEI 0-21			
Clause	Requirement - Test	Result - Remark	Verdict

Graph Active power regulation in coincidence with transitory on the transmission grid Sequence A

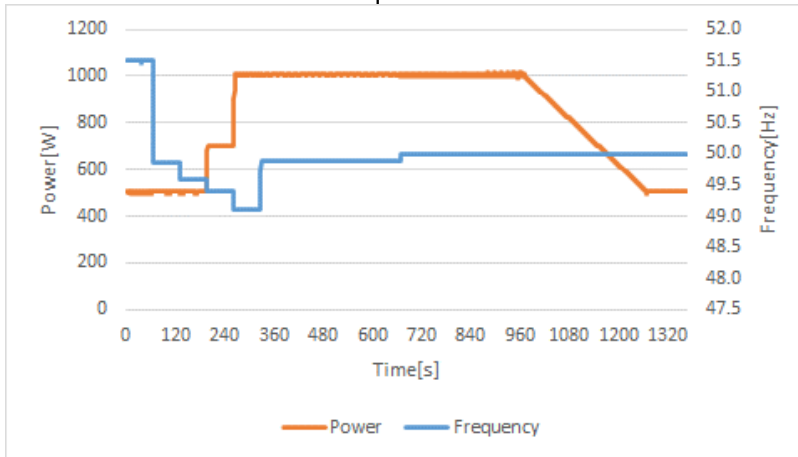

Graph Active power regulation in coincidence with transitory on the transmission grid Sequence B

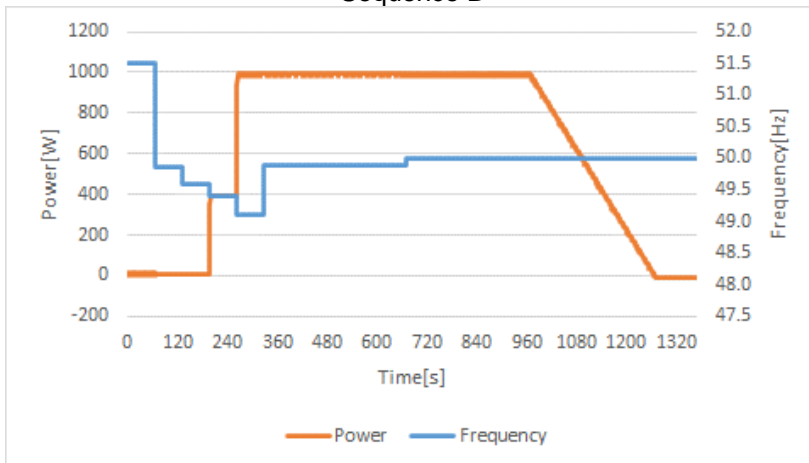

Graph Active power regulation in coincidence with transitory on the transmission grid Sequence C

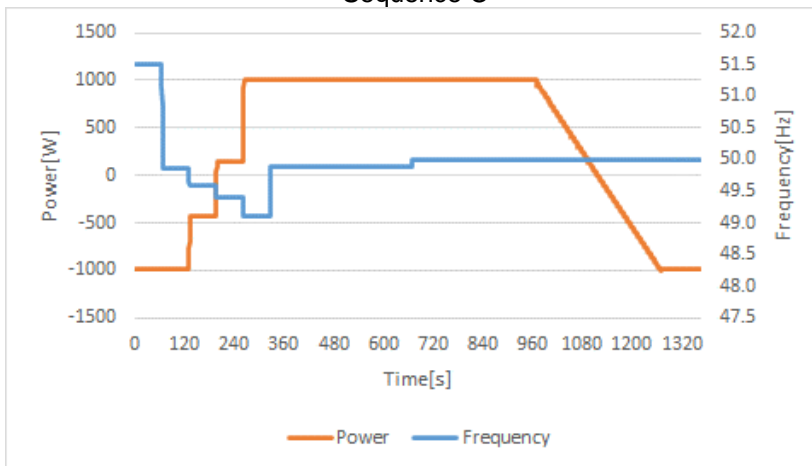

CEI 0-21			
Clause	Requirement - Test	Result - Remark	Verdict

Bbis.7.4	TABLE: Active power limitation in coincidence with external command coming from the Electricity Distributor	P
-----------------	--	----------

Model	VT-6607106+16Battery				
Set Point	P [W]	Actual power [W]	D P/Pn%	Limit [%]	Result
50% P _{SMAX}	2048	2046	-0.06	--	P
30% P _{SMAX}	1229	1216	-0.32	± 2.5 % P _{SMAX}	P
30% P _{CMAX}	-1229	-1182	1.13	± 2.5 % P _{SMAX}	P

The test must be performed according to the following steps:

- Bring the storage system to 50% of the active power available for injection.
- Send to the generator an active power set-point equal to 30% of the P_{SMAX}.
- Maintain the set-point for a time of 60 s, compatibly with the energy capacity of the storage system.
- Measure the active power delivered by the inverter, at least 30 seconds after the command of the new active power regulation set-point is sent (this is to ensure that the system has reached the steady state).

The test is considered to have been successfully passed if the maximum deviation between the assigned level and the current measured value (average value with a window of 1 min.) For the active power is less than ± 2.5%P_{SMAX}.

In the case of storage systems connected to bidirectional converters, repeat the test at 30% of the P_{CMAX}.

Diagram:

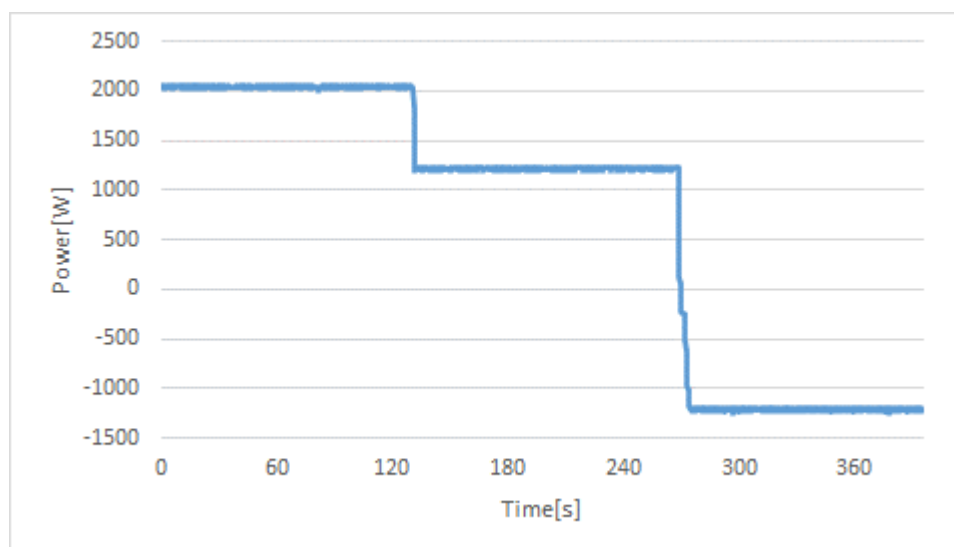

CEI 0-21			
Clause	Requirement - Test	Result - Remark	Verdict

Bbis.7.4	TABLE: Active power limitation in coincidence with external command coming from the Electricity Distributor	P
-----------------	--	----------

Model	VT-6607106+1Battery				
Set Point	P [W]	Actual power [W]	D P/Pn%	Limit [%]	Result
50% P _{SMAX}	2048	2041	-0.18	--	P
30% P _{SMAX}	1229	1210	-0.46	± 2.5 % P _{SMAX}	P
30% P _{CMAX}	-1229	-1188	1.01	± 2.5 % P _{SMAX}	P

The test must be performed according to the following steps:

- Bring the storage system to 50% of the active power available for injection.
- Send to the generator an active power set-point equal to 30% of the P_{SMAX}.
- Maintain the set-point for a time of 60 s, compatibly with the energy capacity of the storage system.
- Measure the active power delivered by the inverter, at least 30 seconds after the command of the new active power regulation set-point is sent (this is to ensure that the system has reached the steady state).

The test is considered to have been successfully passed if the maximum deviation between the assigned level and the current measured value (average value with a window of 1 min.) For the active power is less than ± 2.5%P_{SMAX}.

In the case of storage systems connected to bidirectional converters, repeat the test at 30% of the P_{CMAX}.

Diagram:

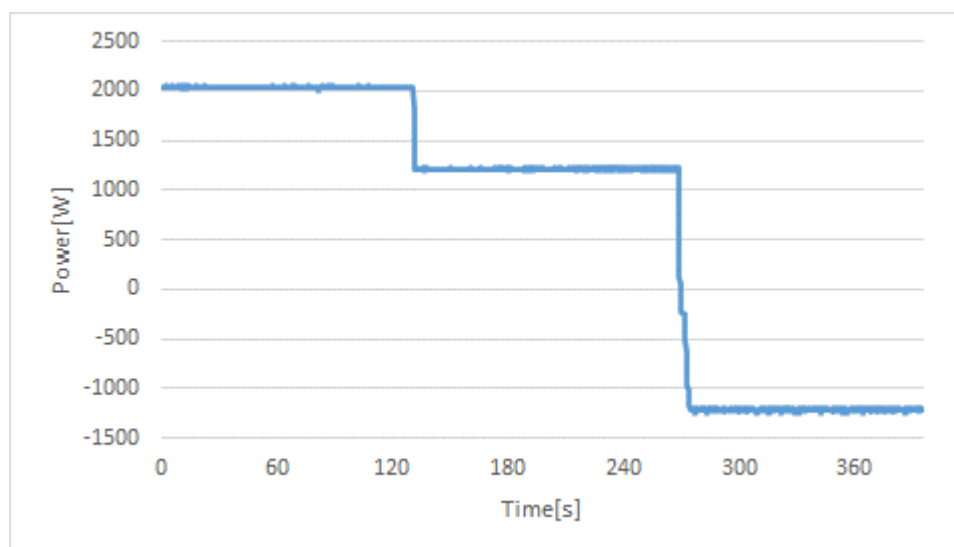

CEI 0-21			
Clause	Requirement - Test	Result - Remark	Verdict

Bbis.7.4	TABLE: Active power limitation in coincidence with external command coming from the Electricity Distributor	P
-----------------	--	----------

Model	VT-6607100+1Battery				
Set Point	P [W]	Actual power [W]	D P/Pn%	Limit [%]	Result
50% P _{SMAX}	500	513	1.26	--	P
30% P _{SMAX}	300	305	0.54	± 2.5 % P _{SMAX}	P
30% P _{CMAX}	-300	-303	-0.27	± 2.5 % P _{SMAX}	P

The test must be performed according to the following steps:

- Bring the storage system to 50% of the active power available for injection.
- Send to the generator an active power set-point equal to 30% of the P_{SMAX}.
- Maintain the set-point for a time of 60 s, compatibly with the energy capacity of the storage system.
- Measure the active power delivered by the inverter, at least 30 seconds after the command of the new active power regulation set-point is sent (this is to ensure that the system has reached the steady state).

The test is considered to have been successfully passed if the maximum deviation between the assigned level and the current measured value (average value with a window of 1 min.) For the active power is less than ± 2.5%P_{SMAX}.

In the case of storage systems connected to bidirectional converters, repeat the test at 30% of the P_{CMAX}.

Diagram:

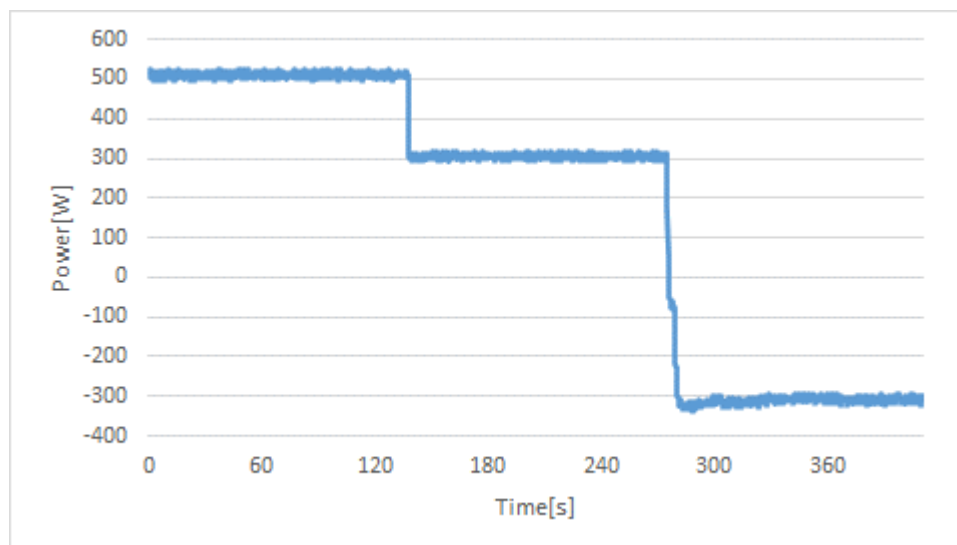

CEI 0-21			
Clause	Requirement - Test	Result - Remark	Verdict

Bbis.7.4.1	TABLE: Verification of the settling time at a power increase / decrease command						P
Model	VT-6607106+16Battery						
Set Point	P [W]	Actual power [W]	Setting time (s)	D P/Pn (%)	Deviation Limit	Setting time	
Bidirectional converters							
100% P _{SMAX} 30% P _{CMAX}	-1228.8	-1236	24	-0.17	± 2.5 % P _n	≤ 50 s	
100% P _{CMAX} 50% P _{SMAX}	2048	2052	28	0.09	± 2.5 % P _n	≤ 50 s	
Unidirectional converters							
100% P _{SMAX} 30% P _{SMAX}	--	--	--	--	± 2.5 % P _n	≤ 50 s	
0% P _{SMAX} 50% P _{SMAX}	--	--	--	--	± 2.5 % P _n	≤ 50 s	
<p>To check the settling time at a command to reduce the active power delivered, or increase the active power absorbed, the test is carried out:</p> <ul style="list-style-type: none"> –for storage systems connected to bidirectional converters, by adjusting the regulation parameter from 100%P_{SMAX} to 30% P_{CMAX} at time t₀; –for storage systems connected to unidirectional converters, by adjusting the regulation parameter from 100% P_{SMAX} to 30% P_{SMAX} at time t₀. <p>To check the settling time at a command to increase the active power, or reduce the absorbed active power, the test is carried out:</p> <ul style="list-style-type: none"> –for storage systems connected to bidirectional converters, by adjusting the regulation parameter from 100%P_{CMAX} to 50% P_{SMAX} at time t₀; –for storage systems connected to unidirectional converters, by adjusting the regulation parameter from 0%P_{SMAX} to 50%P_{SMAX} at time t₀. <p>The settling time is the time interval from the instant t₀ of application of the step of increasing / limiting the active power (e.g. 100%P_{SMAX} ->30%P_{SMAX}) to the instant in which the power is stably within a tolerance band of ± 2.5%S_n with respect to the new set value.</p> <p>The maximum measured settling time must be less than 50 s, and in any case not more than 60 s if the limitation command provides for the passage from 100%S_n to 15%S_n.</p>							

CEI 0-21			
Clause	Requirement - Test	Result - Remark	Verdict

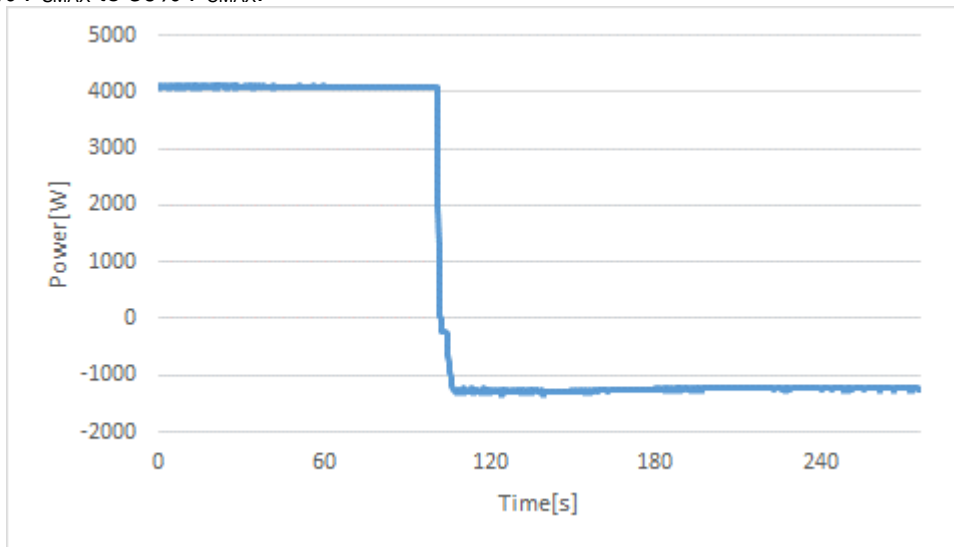
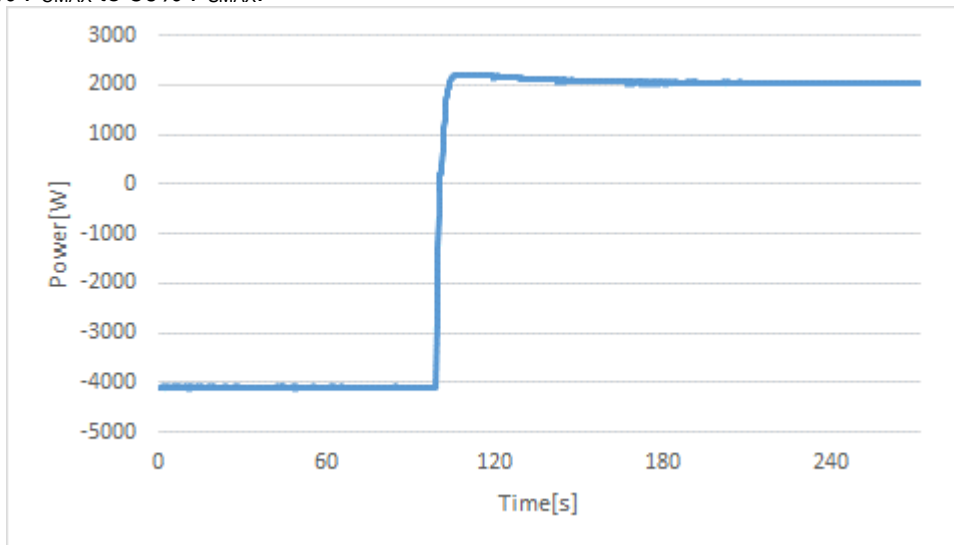
Graph: 100% P_{SMAX} to 30% P_{CMAX}:Graph: 100% P_{CMAX} to 50% P_{SMAX}:

CEI 0-21			
Clause	Requirement - Test	Result - Remark	Verdict

Bbis.7.4.1	TABLE: Verification of the settling time at a power increase / decrease command						P
Model	VT-6607106+1Battery						
Set Point	P [W]	Actual power [W]	Setting time (s)	D P/Pn (%)	Deviation Limit	Setting time	
Bidirectional converters							
100% P _S MAX 30% P _C MAX	-1228.8	-1245	22	-0.39	± 2.5 % P _n	≤ 50 s	
100% P _C MAX 50% P _S MAX	2048	2057	27	0.21	± 2.5 % P _n	≤ 50 s	
Unidirectional converters							
100% P _S MAX 30% P _S MAX	--	--	--	--	± 2.5 % P _n	≤ 50 s	
0% P _S MAX 50% P _S MAX	--	--	--	--	± 2.5 % P _n	≤ 50 s	
<p>To check the settling time at a command to reduce the active power delivered, or increase the active power absorbed, the test is carried out:</p> <ul style="list-style-type: none"> –for storage systems connected to bidirectional converters, by adjusting the regulation parameter from 100%P_SMAX to 30% P_CMAX at time t₀; –for storage systems connected to unidirectional converters, by adjusting the regulation parameter from 100% P_SMAX to 30% P_SMAX at time t₀. <p>To check the settling time at a command to increase the active power, or reduce the absorbed active power, the test is carried out:</p> <ul style="list-style-type: none"> –for storage systems connected to bidirectional converters, by adjusting the regulation parameter from 100%P_CMAX to 50% P_SMAX at time t₀; –for storage systems connected to unidirectional converters, by adjusting the regulation parameter from 0%P_SMAX to 50%P_SMAX at time t₀. <p>The settling time is the time interval from the instant t₀ of application of the step of increasing / limiting the active power (e.g. 100%P_SMAX ->30%P_SMAX) to the instant in which the power is stably within a tolerance band of ± 2.5%S_n with respect to the new set value.</p> <p>The maximum measured settling time must be less than 50 s, and in any case not more than 60 s if the limitation command provides for the passage from 100%S_n to 15%S_n.</p>							

CEI 0-21			
Clause	Requirement - Test	Result - Remark	Verdict

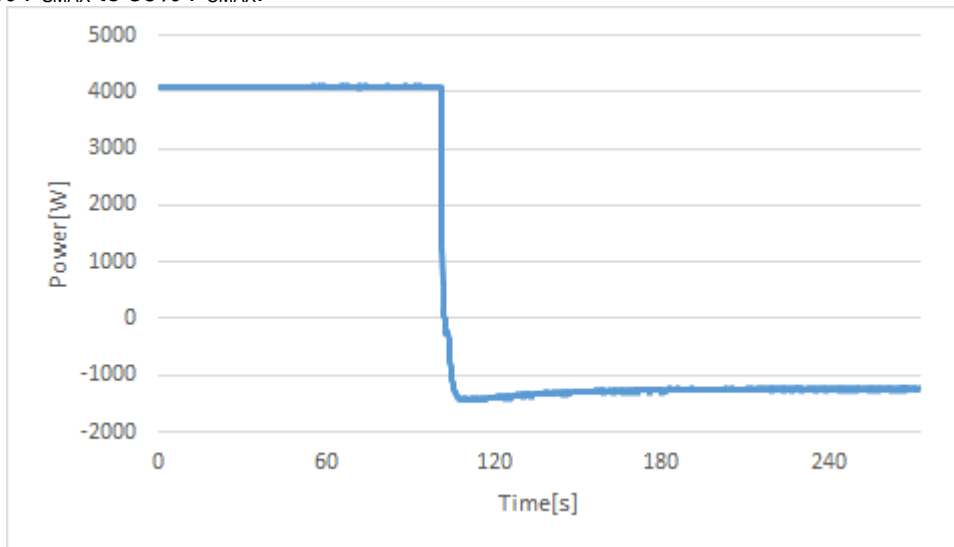
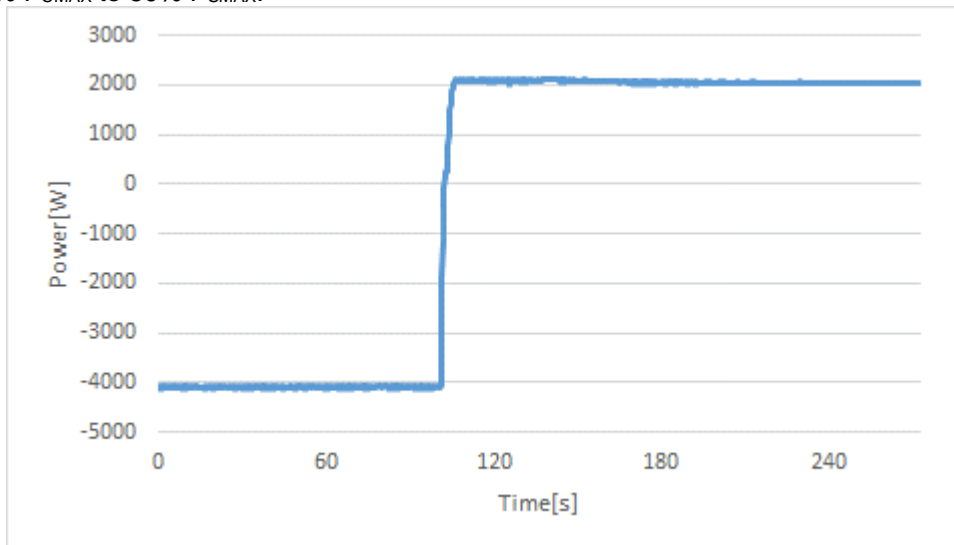
Graph: 100% P_SMAX to 30% P_CMAX:Graph: 100% P_CMAX to 50% P_SMAX:

CEI 0-21			
Clause	Requirement - Test	Result - Remark	Verdict

Bbis.7.4.1	TABLE: Verification of the settling time at a power increase / decrease command						P
Model	VT-6607100+1Battery						
Set Point	P [W]	Actual power [W]	Setting time (s)	D P/Pn (%)	Deviation Limit	Setting time	
Bidirectional converters							
100% P _{SMAX} 30% P _{CMAX}	-300	-303	25	-0.27	± 2.5 % P _n	≤ 50 s	
100% P _{CMAX} 50% P _{SMAX}	500	505	23	0.55	± 2.5 % P _n	≤ 50 s	
Unidirectional converters							
100% P _{SMAX} 30% P _{SMAX}	--	--	--	--	± 2.5 % P _n	≤ 50 s	
0% P _{SMAX} 50% P _{SMAX}	--	--	--	--	± 2.5 % P _n	≤ 50 s	
<p>To check the settling time at a command to reduce the active power delivered, or increase the active power absorbed, the test is carried out:</p> <ul style="list-style-type: none"> –for storage systems connected to bidirectional converters, by adjusting the regulation parameter from 100%P_{SMAX} to 30% P_{CMAX} at time t₀; –for storage systems connected to unidirectional converters, by adjusting the regulation parameter from 100% P_{SMAX} to 30% P_{SMAX} at time t₀. <p>To check the settling time at a command to increase the active power, or reduce the absorbed active power, the test is carried out:</p> <ul style="list-style-type: none"> –for storage systems connected to bidirectional converters, by adjusting the regulation parameter from 100%P_{CMAX} to 50% P_{SMAX} at time t₀; –for storage systems connected to unidirectional converters, by adjusting the regulation parameter from 0%P_{SMAX} to 50%P_{SMAX} at time t₀. <p>The settling time is the time interval from the instant t₀ of application of the step of increasing / limiting the active power (e.g. 100%P_{SMAX} ->30%P_{SMAX}) to the instant in which the power is stably within a tolerance band of ± 2.5%S_n with respect to the new set value.</p> <p>The maximum measured settling time must be less than 50 s, and in any case not more than 60 s if the limitation command provides for the passage from 100%S_n to 15%S_n.</p>							

CEI 0-21			
Clause	Requirement - Test	Result - Remark	Verdict

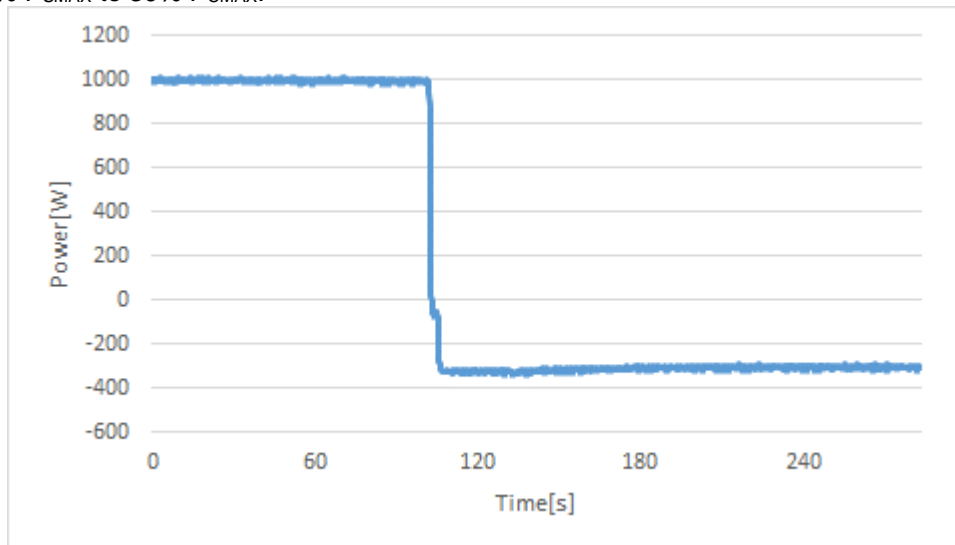
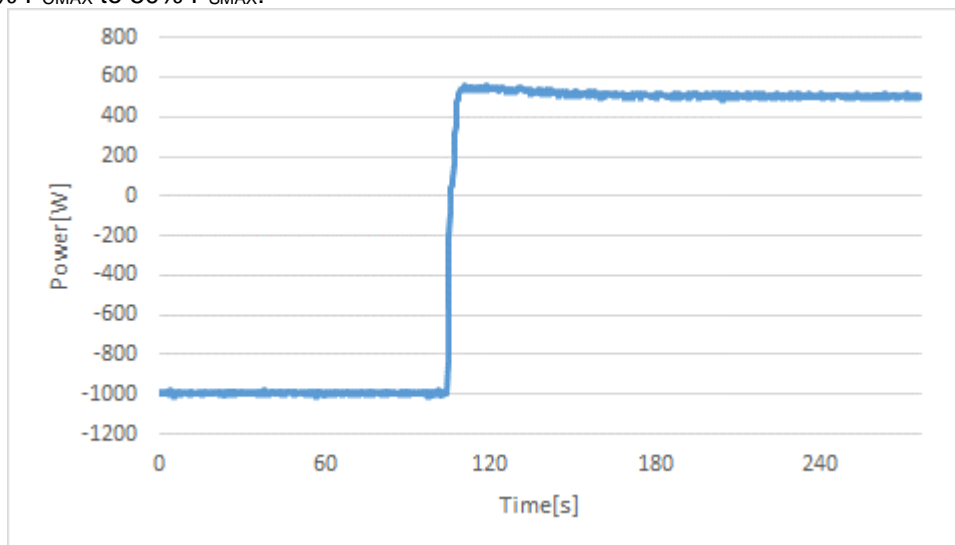
Graph: 100% P_{SMAX} to 30% P_{CMAX} :Graph: 100% P_{CMAX} to 50% P_{SMAX} :

CEI 0-21			
Clause	Requirement - Test	Result - Remark	Verdict

Bbis.8.1	TABLE: Verification of continuous component emission			P
Model	VT-6607106+16Battery			
Completed test				
Power Level [%P_{SMAX}]	(33 ± 5)%	(66 ± 5)%	(100 ± 5)%	
Ambient				
Total output Power (W)	1370	2732	4082	
Output Vrms	229.53	229.65	229.74	
Output Arms	6.12	11.99	17.86	
Cos φ	0.976	0.992	0.995	
L1 DC Component (A)	0.007	0.007	0.007	
L2 DC Component (A)	-	-	-	
L3 DC Component (A)	-	-	-	
L1 DC Component (% I _r)	0.038%	0.038%	0.038%	
L2 DC Component (% I _r)	-	-	-	
L3 DC Component (% I _r)	-	-	-	

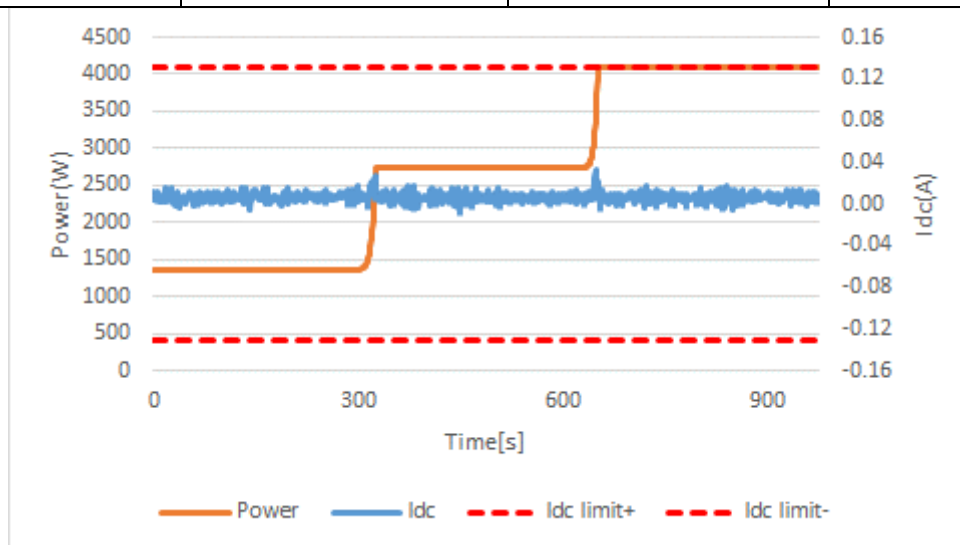

CEI 0-21			
Clause	Requirement - Test	Result - Remark	Verdict

Minimum ambient rating or 20°C			
Total output Power (W)	1369	2731	4082
Output Vrms	229.52	229.62	229.73
Output Arms	6.11	11.99	17.86
Cos φ	0.976	0.992	0.995
L1 DC Component (A)	0.006	0.007	0.007
L2 DC Component (A)	-	-	-
L3 DC Component (A)	-	-	-
L1 DC Component (% I _r)	0.034%	0.039%	0.037%
L2 DC Component (% I _r)	-	-	-
L3 DC Component (% I _r)	-	-	-

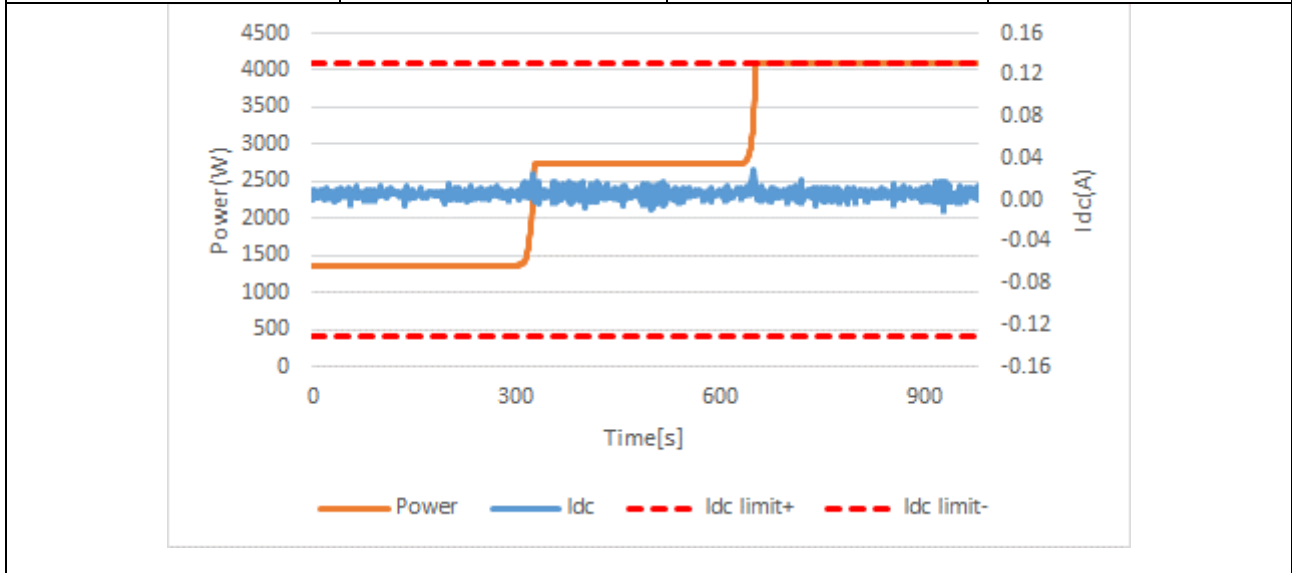

CEI 0-21			
Clause	Requirement - Test	Result - Remark	Verdict

Maximum ambient rating or 60°C			
Total output Power (W)	1368	2732	4084
Output Vrms	229.51	229.63	229.73
Output Arms	6.11	12.00	17.87
Cos φ	0.976	0.992	0.995
L1 DC Component (A)	0.006	0.006	0.006
L2 DC Component (A)	-	-	-
L3 DC Component (A)	-	-	-
L1 DC Component (% I _r)	0.036%	0.034%	0.036%
L2 DC Component (% I _r)	-	-	-
L3 DC Component (% I _r)	-	-	-

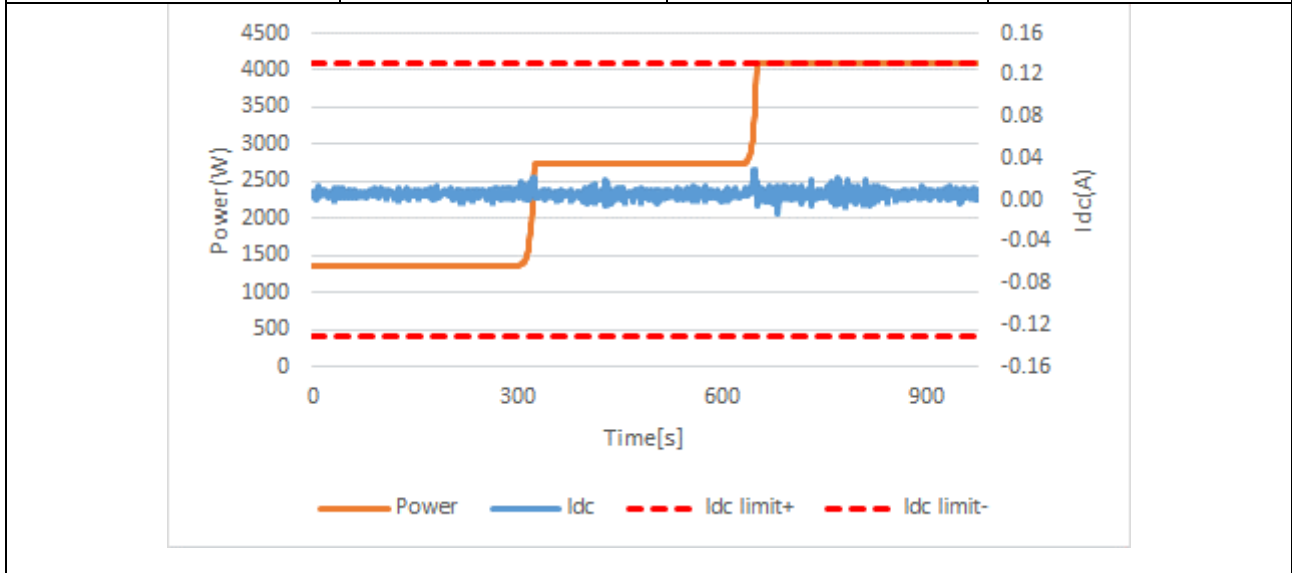

CEI 0-21			
Clause	Requirement - Test	Result - Remark	Verdict

Power Level [%P _C MAX]	(33 ± 5)%	(66 ± 5)%	(100 ± 5)%
Ambient			
Total output Power (W)	-1367	-2729	-4078
Output Vrms	229.55	229.67	229.77
Output Arms	6.11	11.98	17.84
Cos φ	-0.976	-0.992	-0.995
L1 DC Component (A)	0.007	0.006	0.007
L2 DC Component (A)	-	-	-
L3 DC Component (A)	-	-	-
L1 DC Component (% I _r)	0.038%	0.033%	0.037%
L2 DC Component (% I _r)	-	-	-
L3 DC Component (% I _r)	-	-	-

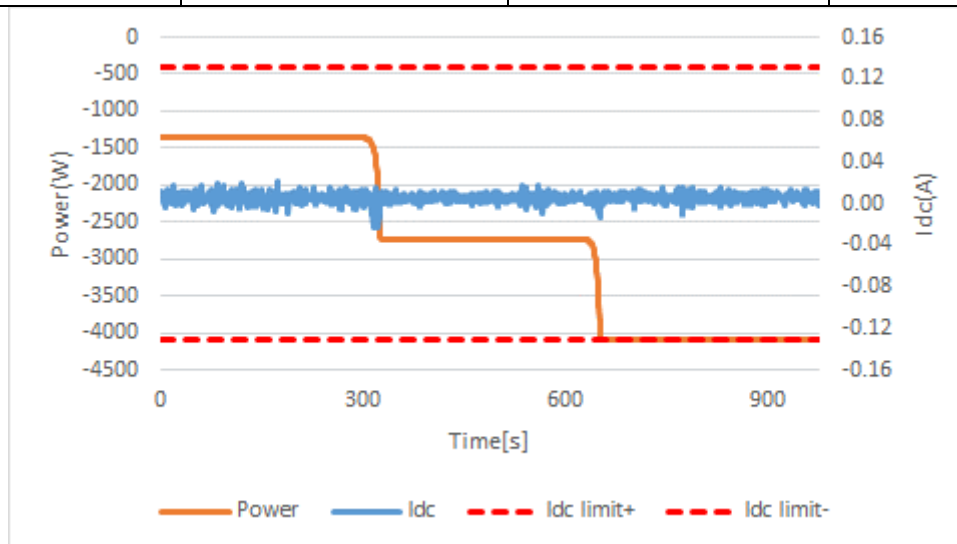

CEI 0-21			
Clause	Requirement - Test	Result - Remark	Verdict

Minimum ambient rating or 20°C			
Total output Power (W)	-1367	-2729	-4079
Output Vrms	229.54	229.65	229.75
Output Arms	6.11	11.98	17.85
Cos φ	-0.976	-0.992	-0.995
L1 DC Component (A)	0.007	0.006	0.006
L2 DC Component (A)	-	-	-
L3 DC Component (A)	-	-	-
L1 DC Component (% I _r)	0.038%	0.033%	0.032%
L2 DC Component (% I _r)	-	-	-
L3 DC Component (% I _r)	-	-	-

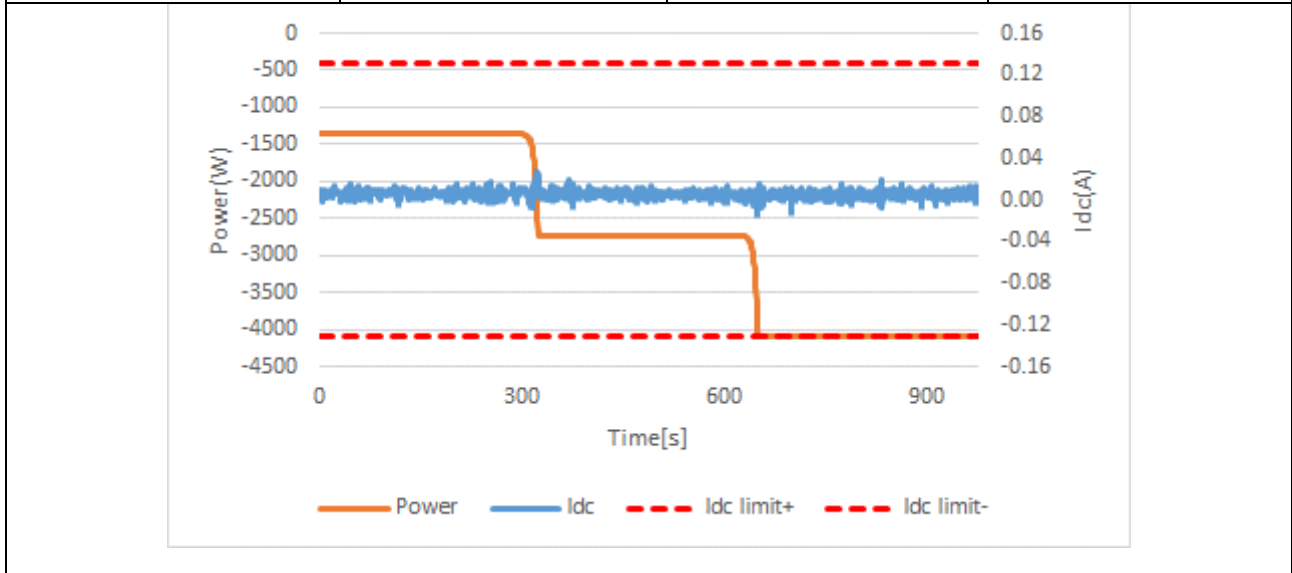

CEI 0-21			
Clause	Requirement - Test	Result - Remark	Verdict

Maximum ambient rating or 60°C			
Total output Power (W)	-1368	-2731	-4082
Output Vrms	229.54	229.63	229.75
Output Arms	6.11	11.99	17.86
Cos φ	-0.976	-0.992	-0.995
L1 DC Component (A)	0.007	0.007	0.007
L2 DC Component (A)	-	-	-
L3 DC Component (A)	-	-	-
L1 DC Component (% I _r)	0.039%	0.041%	0.038%
L2 DC Component (% I _r)	-	-	-
L3 DC Component (% I _r)	-	-	-

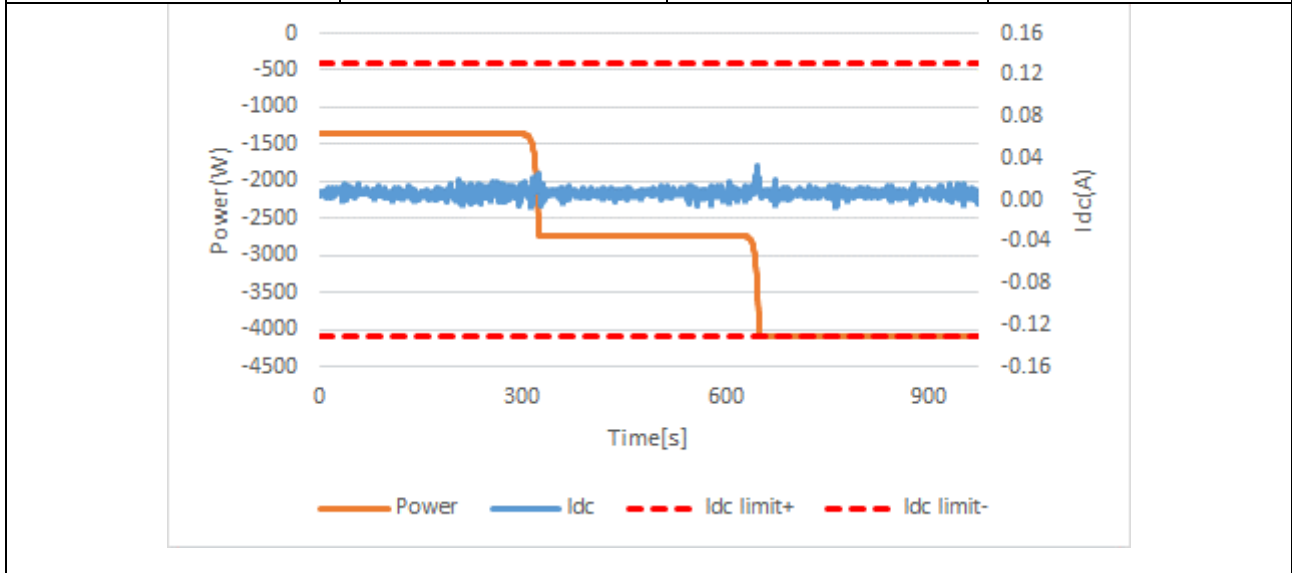

CEI 0-21			
Clause	Requirement - Test	Result - Remark	Verdict

Bbis.8.1	TABLE: Verification of continuous component emission			P
Model	VT-6607106+1Battery			
Completed test-				
Power Level [%P_{SMAX}]	(33 ± 5)%	(66 ± 5)%	(100 ± 5)%	
Ambient				
Total output Power (W)	1368	2732	4084	
Output Vrms	229.49	229.60	229.70	
Output Arms	6.11	12.00	17.87	
Cos φ	0.976	0.992	0.995	
L1 DC Component (A)	0.006	0.005	0.006	
L2 DC Component (A)	-	-	-	
L3 DC Component (A)	-	-	-	
L1 DC Component (% I _r)	0.032%	0.028%	0.032%	
L2 DC Component (% I _r)	-	-	-	
L3 DC Component (% I _r)	-	-	-	

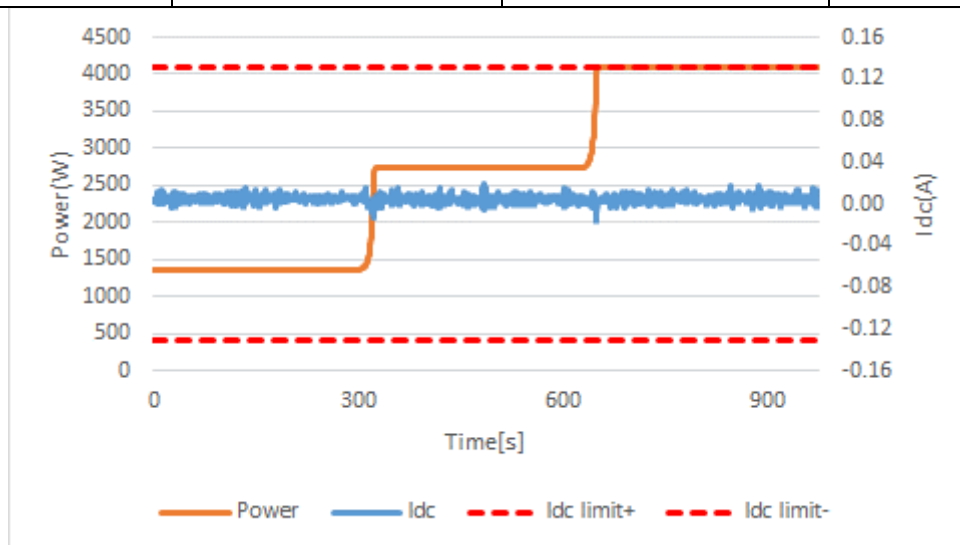

CEI 0-21			
Clause	Requirement - Test	Result - Remark	Verdict

Minimum ambient rating or 20°C			
Total output Power (W)	1370	2735	4085
Output Vrms	229.50	229.60	229.69
Output Arms	6.12	12.01	17.88
Cos φ	0.976	0.992	0.995
L1 DC Component (A)	0.006	0.005	0.005
L2 DC Component (A)	-	-	-
L3 DC Component (A)	-	-	-
L1 DC Component (% I _r)	0.033%	0.030%	0.031%
L2 DC Component (% I _r)	-	-	-
L3 DC Component (% I _r)	-	-	-

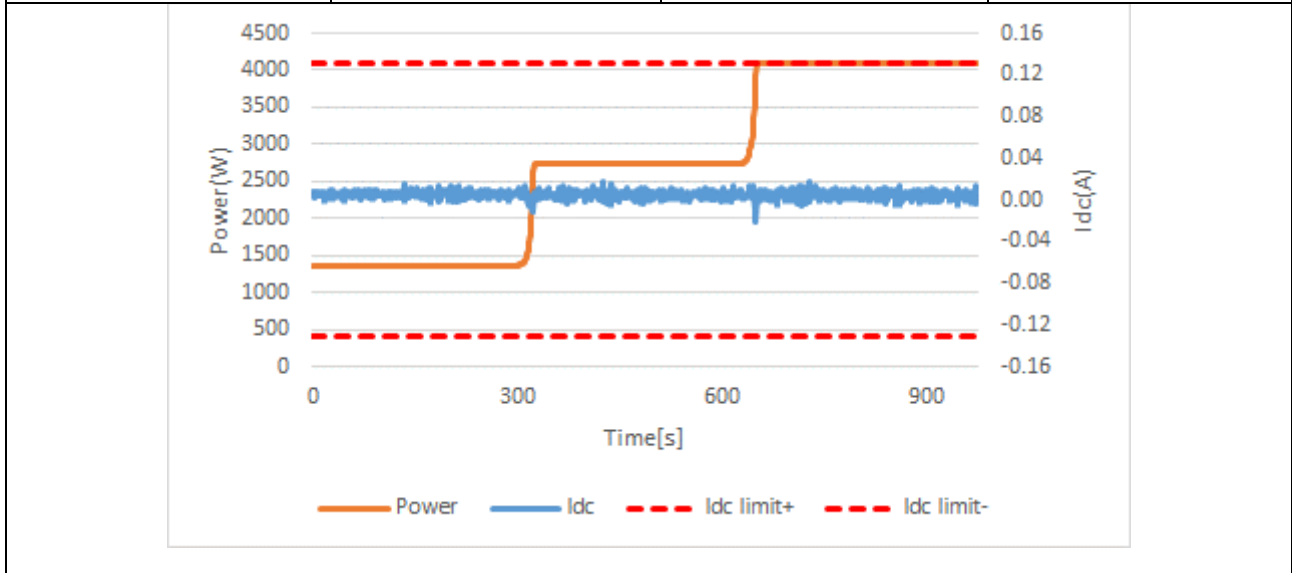

CEI 0-21			
Clause	Requirement - Test	Result - Remark	Verdict

Maximum ambient rating or 60°C			
Total output Power (W)	1369	2734	4085
Output Vrms	229.64	229.76	229.85
Output Arms	6.11	11.99	17.86
Cos φ	0.976	0.992	0.995
L1 DC Component (A)	0.006	0.005	0.006
L2 DC Component (A)	-	-	-
L3 DC Component (A)	-	-	-
L1 DC Component (% I _r)	0.032%	0.031%	0.035%
L2 DC Component (% I _r)	-	-	-
L3 DC Component (% I _r)	-	-	-

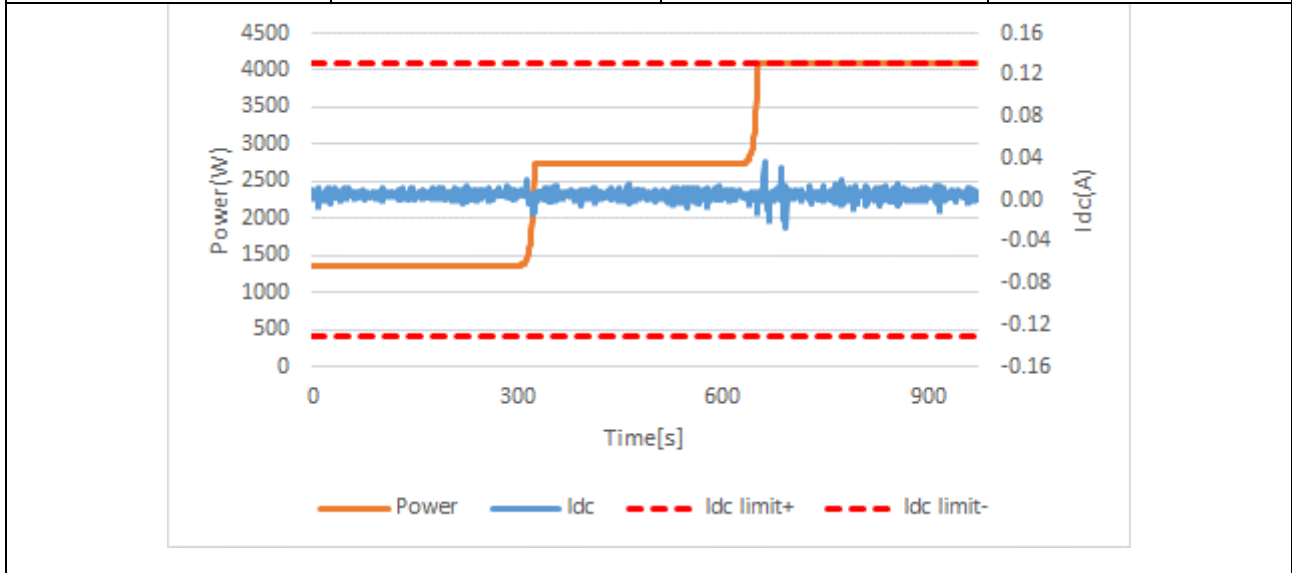

CEI 0-21			
Clause	Requirement - Test	Result - Remark	Verdict

Power Level [%P _C MAX]	(33 ± 5)%	(66 ± 5)%	(100 ± 5)%
Ambient			
Total output Power (W)	-1369	-2732	-4083
Output Vrms	229.57	229.70	229.77
Output Arms	6.11	11.99	17.86
Cos φ	-0.976	-0.992	-0.995
L1 DC Component (A)	0.005	0.006	0.006
L2 DC Component (A)	-	-	-
L3 DC Component (A)	-	-	-
L1 DC Component (% I _r)	0.030%	0.031%	0.034%
L2 DC Component (% I _r)	-	-	-
L3 DC Component (% I _r)	-	-	-

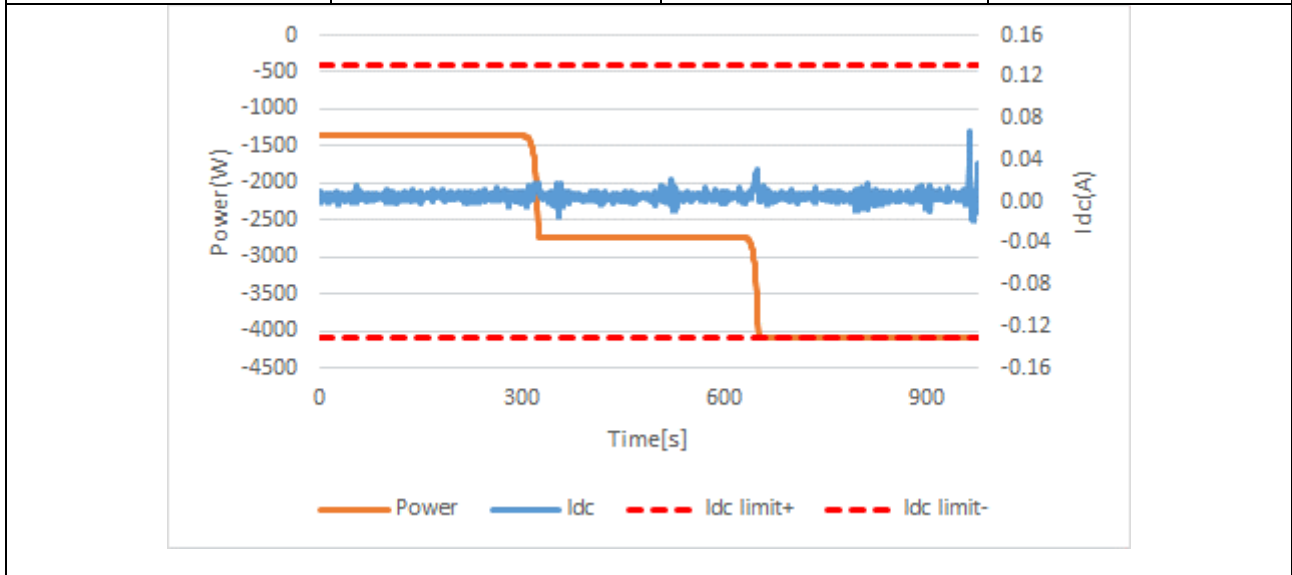

CEI 0-21			
Clause	Requirement - Test	Result - Remark	Verdict

Minimum ambient rating or 20°C			
Total output Power (W)	-1368	-2732	-4083
Output Vrms	229.51	229.61	229.71
Output Arms	6.11	11.99	17.87
Cos φ	-0.976	-0.992	-0.995
L1 DC Component (A)	0.006	0.005	0.005
L2 DC Component (A)	-	-	-
L3 DC Component (A)	-	-	-
L1 DC Component (% I _r)	0.031%	0.031%	0.029%
L2 DC Component (% I _r)	-	-	-
L3 DC Component (% I _r)	-	-	-

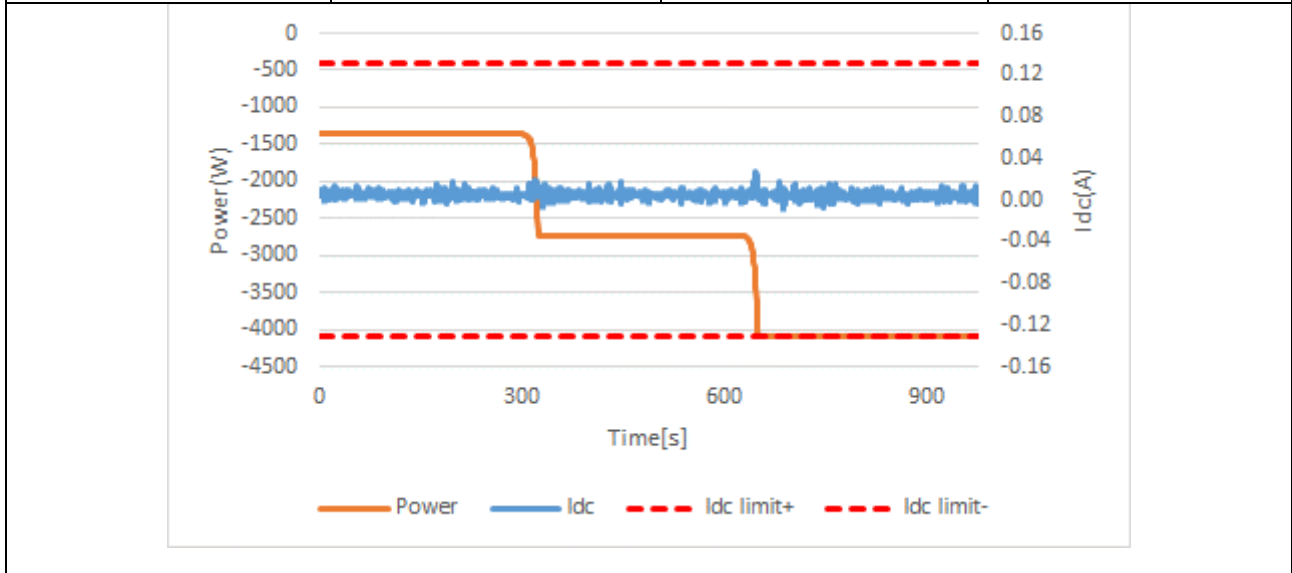

CEI 0-21			
Clause	Requirement - Test	Result - Remark	Verdict

Maximum ambient rating or 60°C			
Total output Power (W)	-1368	-2733	-4085
Output Vrms	229.49	229.61	229.71
Output Arms	6.11	12.00	17.88
Cos φ	-0.976	-0.992	-0.995
L1 DC Component (A)	0.006	0.006	0.006
L2 DC Component (A)	-	-	-
L3 DC Component (A)	-	-	-
L1 DC Component (% I _r)	0.034%	0.033%	0.032%
L2 DC Component (% I _r)	-	-	-
L3 DC Component (% I _r)	-	-	-

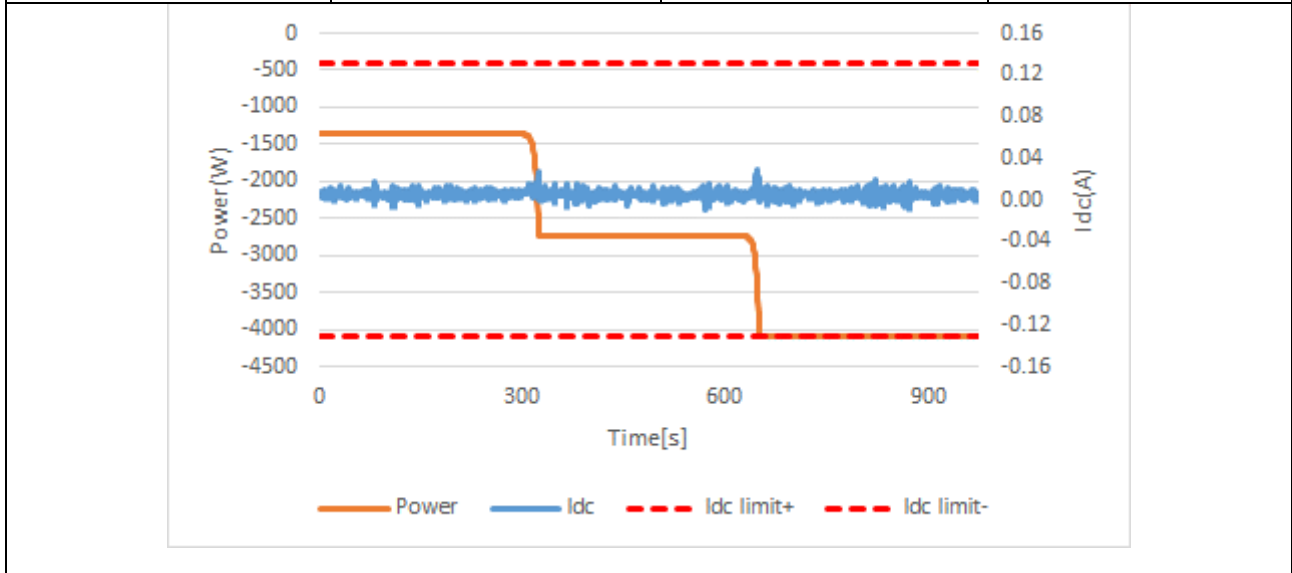

CEI 0-21			
Clause	Requirement - Test	Result - Remark	Verdict

Bbis.8.1	TABLE: Verification of continuous component emission			P
Model	VT-6607100+1Battery			
Completed test				
Power Level [%P _{SMAX}]	(33 ± 5)%	(66 ± 5)%	(100 ± 5)%	
Ambient				
Total output Power (W)	328	663	991	
Output Vrms	229.39	229.41	229.45	
Output Arms	1.91	3.16	4.52	
Cos φ	0.747	0.913	0.957	
L1 DC Component (A)	0.005	0.005	0.005	
L2 DC Component (A)	-	-	-	
L3 DC Component (A)	-	-	-	
L1 DC Component (% I _r)	0.109%	0.110%	0.106%	
L2 DC Component (% I _r)	-	-	-	
L3 DC Component (% I _r)	-	-	-	

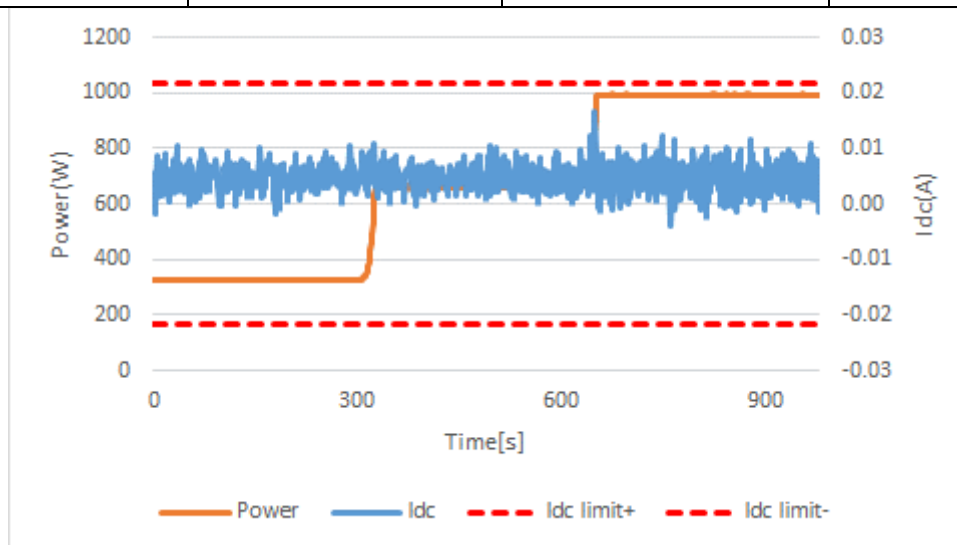

CEI 0-21			
Clause	Requirement - Test	Result - Remark	Verdict

Minimum ambient rating or 20°C			
Total output Power (W)	327	662	991
Output Vrms	229.39	229.41	229.44
Output Arms	1.91	3.16	4.51
Cos ϕ	0.746	0.913	0.957
L1 DC Component (A)	0.004	0.004	0.004
L2 DC Component (A)	-	-	-
L3 DC Component (A)	-	-	-
L1 DC Component (% I_r)	0.098%	0.094%	0.095%
L2 DC Component (% I_r)	-	-	-
L3 DC Component (% I_r)	-	-	-

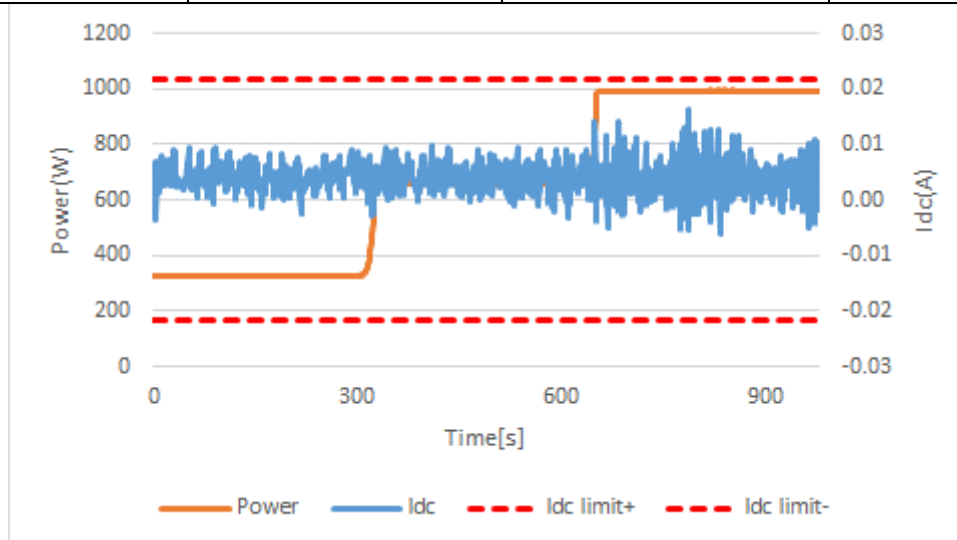

CEI 0-21			
Clause	Requirement - Test	Result - Remark	Verdict

Maximum ambient rating or 60°C			
Total output Power (W)	327	662	992
Output Vrms	229.38	229.42	229.45
Output Arms	1.91	3.16	4.52
Cos φ	0.746	0.913	0.957
L1 DC Component (A)	0.004	0.004	0.004
L2 DC Component (A)	-	-	-
L3 DC Component (A)	-	-	-
L1 DC Component (% I _r)	0.098%	0.093%	0.090%
L2 DC Component (% I _r)	-	-	-
L3 DC Component (% I _r)	-	-	-

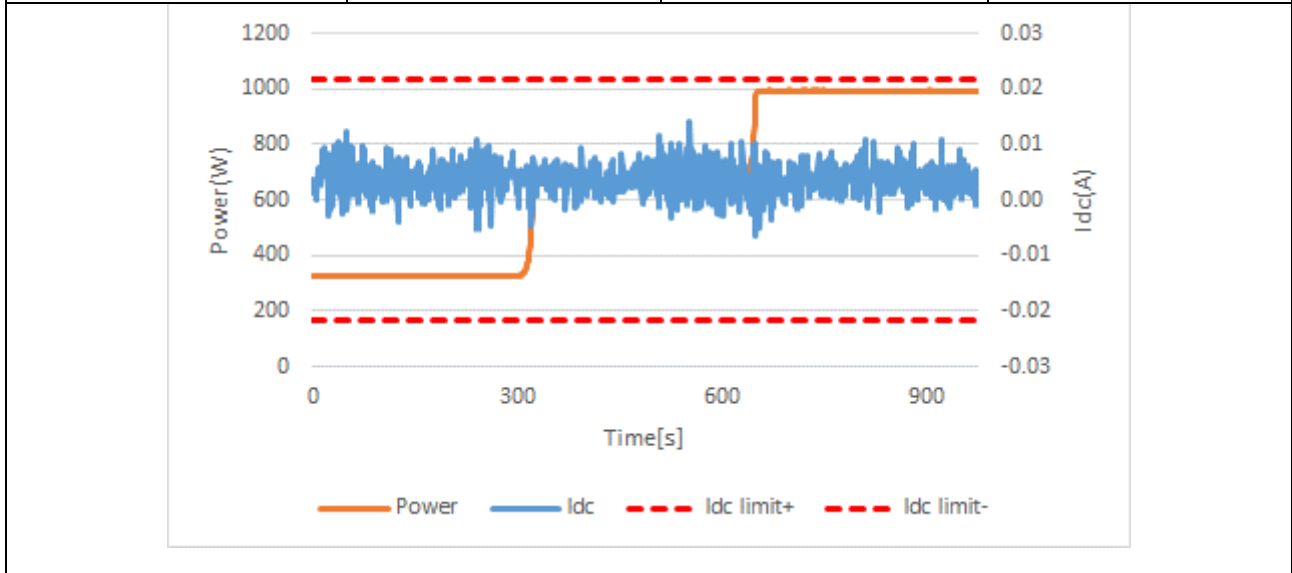

CEI 0-21			
Clause	Requirement - Test	Result - Remark	Verdict

Power Level [%P _{C_{MAX}}]	(33 ± 5)%	(66 ± 5)%	(100 ± 5)%
Ambient			
Total output Power (W)	-328	-663	-991
Output Vrms	229.38	229.41	229.46
Output Arms	1.91	3.16	4.52
Cos φ	-0.747	-0.913	-0.957
L1 DC Component (A)	0.005	0.005	0.004
L2 DC Component (A)	-	-	-
L3 DC Component (A)	-	-	-
L1 DC Component (% I _r)	0.122%	0.109%	0.099%
L2 DC Component (% I _r)	-	-	-
L3 DC Component (% I _r)	-	-	-

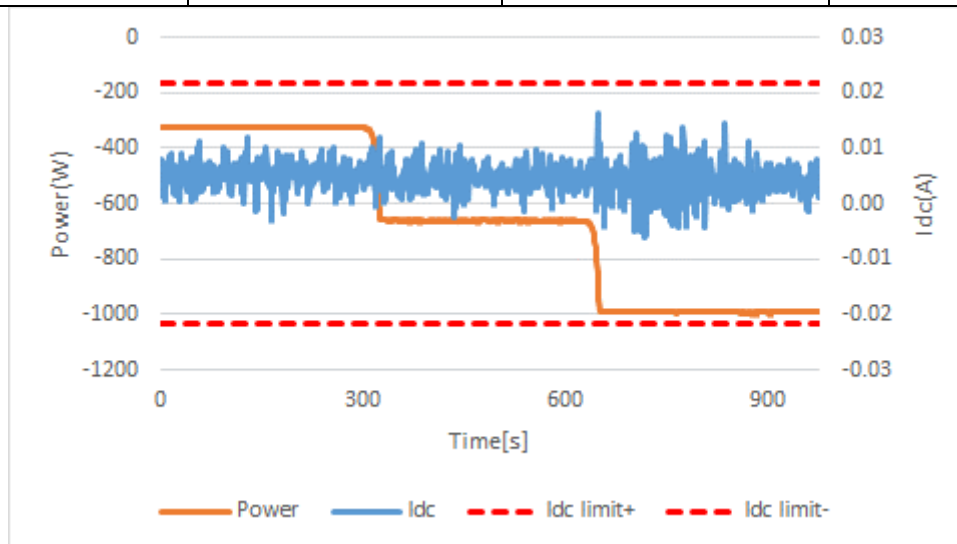

CEI 0-21			
Clause	Requirement - Test	Result - Remark	Verdict

Minimum ambient rating or 20°C			
Total output Power (W)	-327	-662	-991
Output Vrms	229.39	229.40	229.44
Output Arms	1.91	3.16	4.52
Cos φ	-0.746	-0.913	-0.957
L1 DC Component (A)	0.005	0.005	0.005
L2 DC Component (A)	-	-	-
L3 DC Component (A)	-	-	-
L1 DC Component (% I _r)	0.120%	0.118%	0.108%
L2 DC Component (% I _r)	-	-	-
L3 DC Component (% I _r)	-	-	-

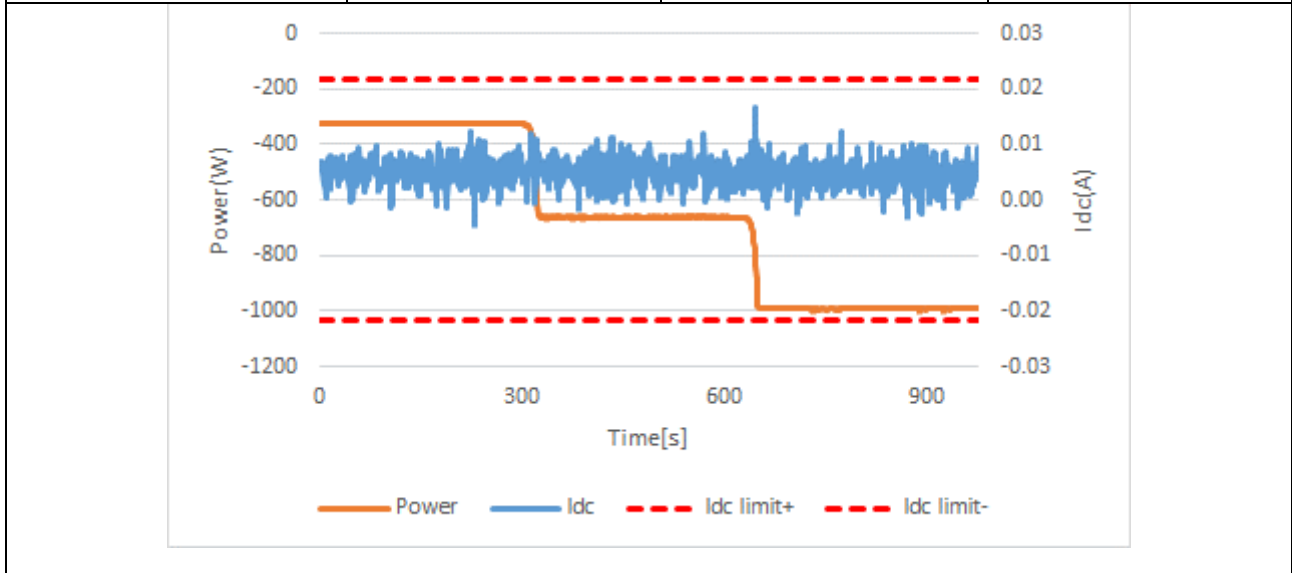

CEI 0-21			
Clause	Requirement - Test	Result - Remark	Verdict

Maximum ambient rating or 60°C			
Total output Power (W)	-327	-663	-992
Output Vrms	229.38	229.41	229.46
Output Arms	1.91	3.16	4.52
Cos φ	-0.746	-0.913	-0.957
L1 DC Component (A)	0.005	0.005	0.005
L2 DC Component (A)	-	-	-
L3 DC Component (A)	-	-	-
L1 DC Component (% I _r)	0.125%	0.120%	0.115%
L2 DC Component (% I _r)	-	-	-
L3 DC Component (% I _r)	-	-	-

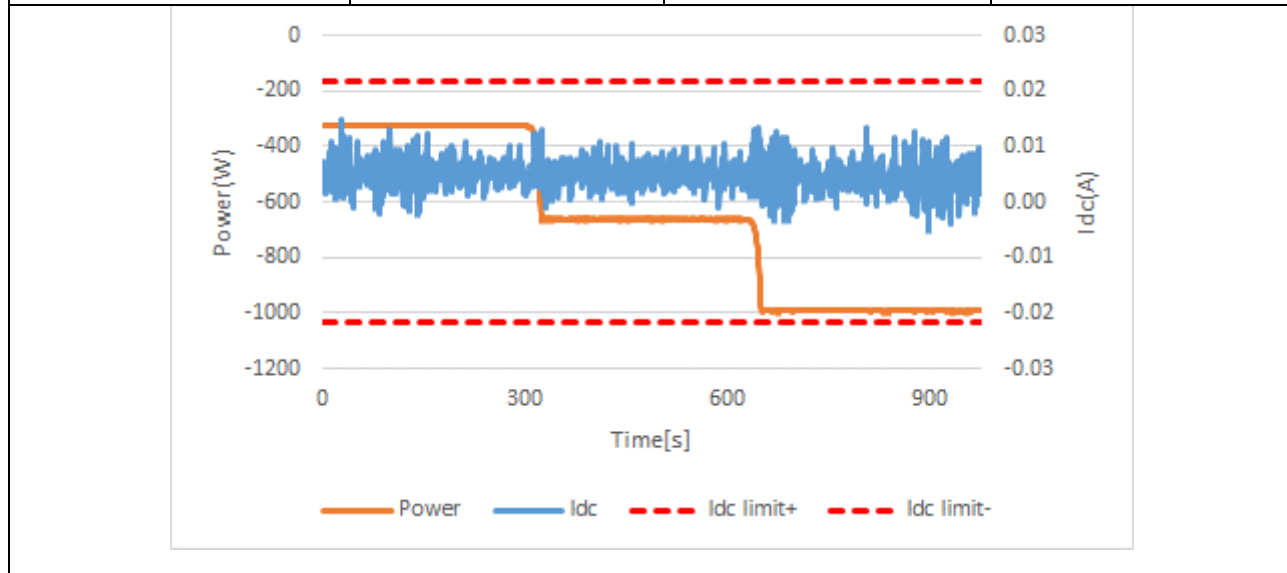

CEI 0-21			
Clause	Requirement - Test	Result - Remark	Verdict

Bbis.8.2	TABLE: Verification of protections against the continuous DC injection			P
Model	VT-6607106+16Battery			
Actual Power [%P _S MAX]	Limits	Measurement [mA]	Limiting value[mA]	Disconnection time [ms]
Ambient 25°C, I_{dc} = 0,5% of I_{nom}				
33%	+0,5%I _{nom} /1s	89.21	89.04	978.40
66%	+0,5%I _{nom} /1s	89.15	89.04	946.40
100%	+0,5%I _{nom} /1s	89.12	89.04	929.70
Minimum ambient rating or 20°C, I_{dc} = 0,5% of I_{nom}				
33%	+0,5%I _{nom} /1s	89.91	89.04	942.70
66%	+0,5%I _{nom} /1s	89.15	89.04	966.80
100%	+0,5%I _{nom} /1s	89.91	89.04	983.90
Maximum ambient rating or 60°C, I_{dc} = 0,5% of I_{nom}				
33%	+0,5%I _{nom} /1s	89.93	89.04	928.30
66%	+0,5%I _{nom} /1s	89.23	89.04	961.00
100%	+0,5%I _{nom} /1s	89.33	89.04	909.30
Ambient 25°C, I_{dc} = 1A				
33%	+1A I _{dc} /200ms	1061	1000	150.90
66%	+1A I _{dc} /200ms	1062	1000	165.60
100%	+1A I _{dc} /200ms	1062	1000	178.01
Minimum ambient rating or 20°C, I_{dc} = 1A				
33%	+1A I _{dc} /200ms	1061	1000	192.10
66%	+1A I _{dc} /200ms	1061	1000	176.70
100%	+1A I _{dc} /200ms	1062	1000	165.80
Maximum ambient rating or 60°C, I_{dc} = 1A				
33%	+1A I _{dc} /200ms	1062	1000	182.20
66%	+1A I _{dc} /200ms	1060	1000	176.90
100%	+1A I _{dc} /200ms	1061	1000	192.20
Actual Power [%P _C MAX]	Limits	Measurement [mA]	Limiting value [mA]	Disconnection time [ms]
Ambient 25°C, I_{dc} = 0,5% of I_{nom}				
33%	+0,5%I _{nom} /1s	89.65	89.04	971.90
66%	+0,5%I _{nom} /1s	89.52	89.04	949.60
100%	+0,5%I _{nom} /1s	89.72	89.04	979.70
Minimum ambient rating or 20°C, I_{dc} = 0,5% of I_{nom}				
33%	+0,5%I _{nom} /1s	89.39	89.04	925.20
66%	+0,5%I _{nom} /1s	89.57	89.04	957.60

CEI 0-21				
Clause	Requirement - Test	Result - Remark		Verdict
100%	+0,5%I _{nom} /1s	89.75	89.04	930.50
Maximum ambient rating or 60°C, I_{dc} = 0,5% of I_{nom}				
33%	+0,5%I _{nom} /1s	89.78	89.04	929.80
66%	+0,5%I _{nom} /1s	89.52	89.04	934.60
100%	+0,5%I _{nom} /1s	89.71	89.04	981.70
Ambient 25°C, I_{dc} = 1A				
33%	+1A I _{dc} /200ms	1061	1000	187.20
66%	+1A I _{dc} /200ms	1062	1000	152.30
100%	+1A I _{dc} /200ms	1060	1000	177.00
Minimum ambient rating or 20°C, I_{dc} = 1A				
33%	+1A I _{dc} /200ms	1060	1000	178.00
66%	+1A I _{dc} /200ms	1065	1000	152.89
100%	+1A I _{dc} /200ms	1065	1000	168.60
Maximum ambient rating or 60°C, I_{dc} = 1A				
33%	+1A I _{dc} /200ms	1061	1000	182.10
66%	+1A I _{dc} /200ms	1063	1000	171.70
100%	+1A I _{dc} /200ms	1062	1000	156.00
Note: The internal temperature of the EUT must be stabilized.				

CEI 0-21			
Clause	Requirement - Test	Result - Remark	Verdict

Bbis.8.2	TABLE: Verification of protections against the continuous DC injection			P
Model	VT-6607106+1Battery			
Actual Power [%P _S MAX]	Limits	Measurement [mA]	Limiting value[mA]	Disconnection time [ms]
Ambient 25°C, I_{dc} = 0,5% of I_{nom}				
33%	+0,5%I _{nom} /1s	90.21	89.04	992.00
66%	+0,5%I _{nom} /1s	90.23	89.04	991.00
100%	+0,5%I _{nom} /1s	90.25	89.04	990.00
Minimum ambient rating or 20°C, I_{dc} = 0,5% of I_{nom}				
33%	+0,5%I _{nom} /1s	90.38	89.04	995.40
66%	+0,5%I _{nom} /1s	90.25	89.04	993.00
100%	+0,5%I _{nom} /1s	90.44	89.04	992.00
Maximum ambient rating or 60°C, I_{dc} = 0,5% of I_{nom}				
33%	+0,5%I _{nom} /1s	90.43	89.04	995.00
66%	+0,5%I _{nom} /1s	90.42	89.04	995.00
100%	+0,5%I _{nom} /1s	90.41	89.04	997.00
Ambient 25°C, I_{dc} = 1A				
33%	+1A I _{dc} /200ms	1039	1000	192.00
66%	+1A I _{dc} /200ms	1042	1000	196.20
100%	+1A I _{dc} /200ms	1049	1000	196.20
Minimum ambient rating or 20°C, I_{dc} = 1A				
33%	+1A I _{dc} /200ms	1038	1000	193.20
66%	+1A I _{dc} /200ms	1060	1000	195.40
100%	+1A I _{dc} /200ms	1045	1000	195.20
Maximum ambient rating or 60°C, I_{dc} = 1A				
33%	+1A I _{dc} /200ms	1053	1000	195.00
66%	+1A I _{dc} /200ms	1068	1000	198.40
100%	+1A I _{dc} /200ms	1069	1000	195.20
Actual Power [%P _C MAX]	Limits	Measurement [mA]	Limiting value [mA]	Disconnection time [ms]
Ambient 25°C, I_{dc} = 0,5% of I_{nom}				
33%	+0,5%I _{nom} /1s	90.12	89.04	978.00
66%	+0,5%I _{nom} /1s	90.10	89.04	990.00
100%	+0,5%I _{nom} /1s	89.91	89.04	998.00
Minimum ambient rating or 20°C, I_{dc} = 0,5% of I_{nom}				
33%	+0,5%I _{nom} /1s	90.32	89.04	986.00
66%	+0,5%I _{nom} /1s	90.04	89.04	990.00

CEI 0-21				
Clause	Requirement - Test	Result - Remark		Verdict
100%	+0,5%I _{nom} /1s	90.33	89.04	994.00
Maximum ambient rating or 60°C, I_{dc} = 0,5% of I_{nom}				
33%	+0,5%I _{nom} /1s	89.98	89.04	992.00
66%	+0,5%I _{nom} /1s	89.96	89.04	992.00
100%	+0,5%I _{nom} /1s	90.16	89.04	993.00
Ambient 25°C, I_{dc} = 1A				
33%	+1A I _{dc} /200ms	1020	1000	198.00
66%	+1A I _{dc} /200ms	1069	1000	192.00
100%	+1A I _{dc} /200ms	1028	1000	193.20
Minimum ambient rating or 20°C, I_{dc} = 1A				
33%	+1A I _{dc} /200ms	1042	1000	192.80
66%	+1A I _{dc} /200ms	1079	1000	193.40
100%	+1A I _{dc} /200ms	1048	1000	191.20
Maximum ambient rating or 60°C, I_{dc} = 1A				
33%	+1A I _{dc} /200ms	1064	1000	193.40
66%	+1A I _{dc} /200ms	1022	1000	192.00
100%	+1A I _{dc} /200ms	1076	1000	192.40
Note: The internal temperature of the EUT must be stabilized.				

Bbis.8.2	TABLE: Verification of protections against the continuous DC injection			P
Model	VT-6607100+1Battery			
Actual Power [%P _{SMAX}]	Limits	Measurement [mA]	Limiting value[mA]	Disconnection time [ms]
Ambient 25°C, I_{dc} = 0,5% of I_{nom}				
33%	+0,5%I _{nom} /1s	22.03	21.74	924.10
66%	+0,5%I _{nom} /1s	22.03	21.74	971.40
100%	+0,5%I _{nom} /1s	22.09	21.74	957.90
Minimum ambient rating or 20°C, I_{dc} = 0,5% of I_{nom}				
33%	+0,5%I _{nom} /1s	22.05	21.74	943.40
66%	+0,5%I _{nom} /1s	22.03	21.74	915.90
100%	+0,5%I _{nom} /1s	22.06	21.74	974.70
Maximum ambient rating or 60°C, I_{dc} = 0,5% of I_{nom}				
33%	+0,5%I _{nom} /1s	22.07	21.74	982.20
66%	+0,5%I _{nom} /1s	22.03	21.74	935.30
100%	+0,5%I _{nom} /1s	22.04	21.74	924.20
Ambient 25°C, I_{dc} = 1A				
33%	+1A I _{dc} /200ms	1030	1000	163.80

CEI 0-21				
Clause	Requirement - Test		Result - Remark	Verdict
66%	+1A I _{dc} /200ms	1045	1000	162.30
100%	+1A I _{dc} /200ms	1046	1000	171.10
Minimum ambient rating or 20°C, I_{dc} = 1A				
33%	+1A I _{dc} /200ms	1044	1000	183.10
66%	+1A I _{dc} /200ms	1046	1000	177.60
100%	+1A I _{dc} /200ms	1045	1000	172.10
Maximum ambient rating or 60°C, I_{dc} = 1A				
33%	+1A I _{dc} /200ms	1028	1000	173.81
66%	+1A I _{dc} /200ms	1044	1000	184.60
100%	+1A I _{dc} /200ms	1046	1000	168.90
Actual Power [%P _{C_{MAX}}]	Limits	Measurement [mA]	Limiting value [mA]	Disconnection time [ms]
Ambient 25°C, I_{dc} = 0,5% of I_{nom}				
33%	+0,5%I _{nom} /1s	22.30	21.74	944.70
66%	+0,5%I _{nom} /1s	22.27	21.74	983.20
100%	+0,5%I _{nom} /1s	22.32	21.74	959.20
Minimum ambient rating or 20°C, I_{dc} = 0,5% of I_{nom}				
33%	+0,5%I _{nom} /1s	22.26	21.74	951.40
66%	+0,5%I _{nom} /1s	22.30	21.74	912.40
100%	+0,5%I _{nom} /1s	22.40	21.74	916.90
Maximum ambient rating or 60°C, I_{dc} = 0,5% of I_{nom}				
33%	+0,5%I _{nom} /1s	22.29	21.74	978.40
66%	+0,5%I _{nom} /1s	22.24	21.74	955.90
100%	+0,5%I _{nom} /1s	22.23	21.74	972.80
Ambient 25°C, I_{dc} = 1A				
33%	+1A I _{dc} /200ms	1018	1000	153.97
66%	+1A I _{dc} /200ms	1015	1000	179.55
100%	+1A I _{dc} /200ms	1025	1000	166.31
Minimum ambient rating or 20°C, I_{dc} = 1A				
33%	+1A I _{dc} /200ms	1018	1000	163.00
66%	+1A I _{dc} /200ms	1009	1000	179.80
100%	+1A I _{dc} /200ms	1026	1000	184.10
Maximum ambient rating or 60°C, I_{dc} = 1A				
33%	+1A I _{dc} /200ms	1016	1000	186.40
66%	+1A I _{dc} /200ms	1016	1000	168.70
100%	+1A I _{dc} /200ms	1026	1000	192.90
Note: The internal temperature of the EUT must be stabilized.				

CEI 0-21			
Clause	Requirement - Test	Result - Remark	Verdict

Bbis.9	TABLE: Verification of insensitivity to voltage dips (UVRT and OVRT(8.5. 1- figure 30) capability)	P	
---------------	---	----------	--

Model	VT-6607106
-------	------------

These tests have the purpose of verifying that the storage system, when used in plants with a total power greater than 11.08 kW, is insensitive to voltage drops according to the voltage-time profile indicated in Figure 71, based on what is reported in 8.5.1.

- in the hatched area of Figure 71 the storage system must not disconnect from the grid. In this area it is allowed to temporarily interrupt the supply / absorption of the active and reactive power exchanged with the grid before the onset of the fault;
- in the area below (grey) the generator can disconnect from the grid.
- within 400 ms from restoring network voltage to within the range of +10% and -15% of nominal voltage, the generator must return to supplying active and reactive power to the network as before the fault, with a maximum tolerance of $\pm 10\%$ of the nominal voltage of the generator. If voltage returns but remains in the range between 85% and 90%, power distribution may be reduced in relation to the generator limits of output power.

Verification of compliance with the requirements of immunity to voltage drop are carried out according to the test sequences shown in Table 38, to be carried out with the storage system running respectively:

a) between 10% and 30% of P_{SMAX} ;

b) and above 90% of P_{SMAX} .

In general, regardless of the test circuit used, the result of each sequence should be documented as follows:

- Time trend of active power P, reactive power Q, phase voltages at the output terminals (V_r , V_s and V_t) and related phase currents, as moving average rms values of a network cycle and updated every half cycle (10 ms), over a time window that runs from 100 ms before the start of the test and ends at least after 1 000 ms from the end of the voltage transient (in order to verify the restoration of active and reactive power). The voltage transient ends when the voltage returns to more than 85% of the rated voltage value. For phase currents, in addition to the rms value averaged over a period, the peak value for each phase must also be recorded and documented.
- In the same period of observation, the oscillograms of the voltages and phase currents will have to be reported (possibly with enlarged detail of the trend during the rising and falling voltage fronts).
- The calculation method used to determine the power, the power factor and the reactive current must also be described in the test report.

It will therefore be necessary to carry out at least 12 distinct test sequences, corresponding to 2 residual voltage levels to be replicated in order to simulate the cases of symmetrical three-phase and two-phase asymmetric MV and LV faults. Each sequence must then be repeated with the storage system operating at two levels of initial power delivered (a: $10\% * P_{SMAX}$ - $30\% * P_{SMAX}$; b: $> 90\% * P_{SMAX}$).

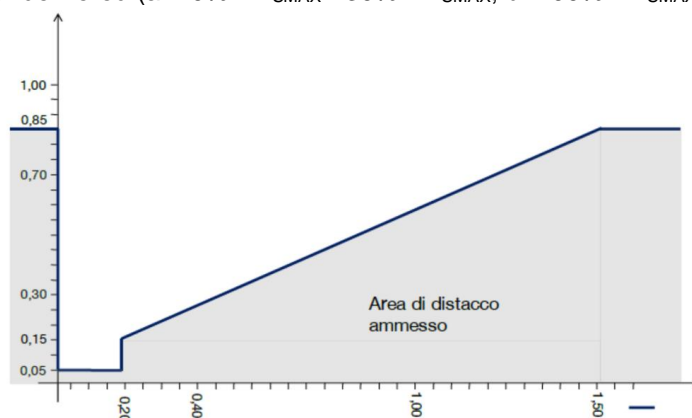

Figure 71 - Requirements for UVRT

CEI 0-21

Clause	Requirement - Test	Result - Remark	Verdict
--------	--------------------	-----------------	---------

Bbis.9.2.2 Alternative test methods - network simulator:

With reference to the list of tests shown in **Table 39**, the voltage drops that are the subject of these tests are caused by faults produced on the low, medium or high voltage distribution line. The types of faults considered are three:

- 1) three-phase symmetrical fault (**Table 39**, Tests No. 1 and 2)

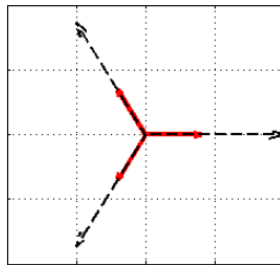

- 2) two-phase asymmetric fault (**Table 39**, Tests No. 3 and 4)

A fault in MV, which causes a variation in LV not only of amplitude but also of the phase relationship of the voltages (the case considered involves the presence of a transformer Dy in the secondary substation).

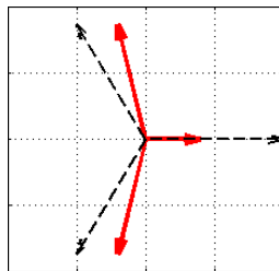

During the two-phase asymmetric fault, the residual amplitude of the 3 voltages and the phase shifts between the phases must comply with the values shown in the following table.

Table 40 - LV phase vectors in the presence of asymmetrical two-phase faults on the primary side of a transformer Dy in the secondary substation





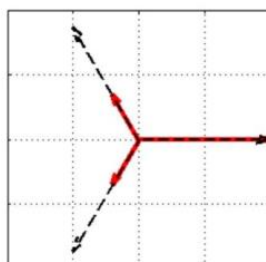





Test No.	V/Vn	Phase-to-earth voltages			Phase angles		
		$u_1/u_{1,n}$	$u_2/u_{2,n}$	$u_3/u_{3,n}$	φ_{u1}	φ_{u2}	φ_{u3}
1a	$0,10 \pm 0,05$	$0,87 \pm 0,05$	$0,87 \pm 0,05$	$0,10 \pm 0,05$	27°	-147°	120°
2a	$0,25 \pm 0,05$	$0,88 \pm 0,05$	$0,88 \pm 0,05$	$0,25 \pm 0,05$	22°	-142°	120°
3a	$0,50 \pm 0,05$	$0,90 \pm 0,05$	$0,90 \pm 0,05$	$0,50 \pm 0,05$	14°	-134°	120°
4a	$0,75 \pm 0,05$	$0,94 \pm 0,05$	$0,94 \pm 0,05$	$0,75 \pm 0,05$	7°	-127°	120°
normal conditions	1	1	1	1	0°	-120°	120°

- 3) LV two-phase asymmetric fault (**Table 39**, Tests No. 5 and 6)



CEI 0-21			
Clause	Requirement - Test	Result - Remark	Verdict

Requirement of LVRT test:**Table 39 - Test sequences to verify immunity to temporary voltage dips. The amplitude, duration and shape relate to no-load test conditions**

List of tests	Residual amplitude of phase-to-phase voltage V/V_{nom}	Drop duration limit [ms]	Power re-supply time after restoring network [ms]	Shape (*)
1s – three-phase symmetrical fault	$0,10 \pm 0,05 (V_1/V_n)$	200 ± 20	400	
1a – two-phase asymmetric failure	$0,10 \pm 0,05 (V_1/V_n)$	200 ± 20	400	
2s – three-phase symmetrical fault	$0,25 \pm 0,05 (V_2/V_n)$	400 ± 20	400	
2a – two-phase asymmetric failure	$0,25 \pm 0,05 (V_2/V_n)$	400 ± 20	400	
3s – three-phase asymmetrical fault	$0,50 \pm 0,05 (V_3/V_n)$	850 ± 20	400	
3a – two-phase asymmetric failure	$0,50 \pm 0,05 (V_3/V_n)$	850 ± 20	400	
4s – three-phase asymmetrical fault	$0,75 \pm 0,05 (V_4/V_n)$	1300 ± 20	400	
4a – two-phase asymmetric failure	$0,75 \pm 0,05 (V_4/V_n)$	1300 ± 20	400	
5 – LV two-phase asymmetrical fault	$0,10 \pm 0,05 (V_5/V_n)$	200 ± 20	400	
6 – LV two-phase asymmetrical fault	$0,50 \pm 0,05 (V_6/V_n)$	850 ± 20	400	

Test No.	V/V_{nom}	Phase-to-earth voltages			Phase angles		
		$U_1/U_{1,nom}$	$U_2/U_{2,nom}$	$U_3/U_{3,nom}$	φ_{U1}	φ_{U2}	φ_{U3}
1s	$0,10 \pm 0,05$	$0,10 \pm 0,05$	$0,10 \pm 0,05$	$0,10 \pm 0,05$	0°	-120°	120°
1a	$0,10 \pm 0,05$	$0,87 \pm 0,05$	$0,87 \pm 0,05$	$0,10 \pm 0,05$	27°	-147°	120°
2s	$0,25 \pm 0,05$	$0,25 \pm 0,05$	$0,25 \pm 0,05$	$0,25 \pm 0,05$	0°	-120°	120°
2a	$0,25 \pm 0,05$	$0,88 \pm 0,05$	$0,88 \pm 0,05$	$0,25 \pm 0,05$	22°	-142°	120°
3s	$0,50 \pm 0,05$	$0,50 \pm 0,05$	$0,50 \pm 0,05$	$0,50 \pm 0,05$	0°	-120°	120°
3a	$0,50 \pm 0,05$	$0,90 \pm 0,05$	$0,90 \pm 0,05$	$0,50 \pm 0,05$	14°	-134°	120°
4s	$0,75 \pm 0,05$	$0,75 \pm 0,05$	$0,75 \pm 0,05$	$0,75 \pm 0,05$	0°	-120°	120°
4a	$0,75 \pm 0,05$	$0,94 \pm 0,05$	$0,94 \pm 0,05$	$0,75 \pm 0,05$	7°	-127°	120°
5	$0,10 \pm 0,05$	1	$0,10 \pm 0,05$	$0,10 \pm 0,05$	0°	-120°	120°
6	$0,50 \pm 0,05$	1	$0,50 \pm 0,05$	$0,50 \pm 0,05$	0°	-120°	120°
normal condition	1	1	1	1	0°	-120°	120°

(*) Regardless of the method used to simulate the transients (simulator or impedance network), the falling and rising edges of the voltage must have a duration of less than 10 ms.

CEI 0-21			
Clause	Requirement - Test	Result - Remark	Verdict

Graph of LVRT and OVRT test:				
Model	VT-6607106+16Battery			
List of tests	Residual amplitude of phase-to-phase voltage V/V_{nom}	Drop duration limit [ms]	Measured drop duration [ms]	Duration of restoring network [ms]
1s – three-phase symmetrical fault (P = 0,1 - 0,3)	$0,10 \pm 0,05 (V_1/V_n)$	200 +20	211	145
1s – three-phase symmetrical fault (P > 0,9)	$0,10 \pm 0,05 (V_1/V_n)$	200 +20	211	145
1a – two-phase asymmetrical fault (P = 0,1 - 0,3)	$0,10 \pm 0,05 (V_1/V_n)$	200 +20	211	108
1a – two-phase asymmetrical fault (P > 0,9)	$0,10 \pm 0,05 (V_1/V_n)$	200 +20	211	116
2s – three-phase symmetrical fault (P = 0,1 - 0,3)	$0,25 \pm 0,05 (V_2/V_n)$	400 +20	411	127
2s – three-phase symmetrical fault (P > 0,9)	$0,25 \pm 0,05 (V_2/V_n)$	400 +20	411	147
2a – three-phase symmetrical fault (P = 0,1 - 0,3)	$0,25 \pm 0,05 (V_2/V_n)$	400 +20	411	115
2a – three-phase symmetrical fault (P > 0,9)	$0,25 \pm 0,05 (V_2/V_n)$	400 +20	411	112
3s – three-phase symmetrical fault (P = 0,1 - 0,3)	$0,50 \pm 0,05 (V_3/V_n)$	850 ± 20	862	149
3s – three-phase symmetrical fault (P > 0,9)	$0,50 \pm 0,05 (V_3/V_n)$	850 ± 20	862	170
3a – two-phase asymmetrical fault (P = 0,1 - 0,3)	$0,50 \pm 0,05 (V_3/V_n)$	850 ± 20	862	118
3a – two-phase asymmetrical fault (P > 0,9)	$0,50 \pm 0,05 (V_3/V_n)$	850 ± 20	862	114
4s – three-phase symmetrical fault (P = 0,1 - 0,3)	$0,75 \pm 0,05 (V_4/V_n)$	1300 ± 20	1311	115
4s – three-phase symmetrical fault (P > 0,9)	$0,75 \pm 0,05 (V_4/V_n)$	1300 ± 20	1311	155
4a – two-phase asymmetrical fault (P = 0,1 - 0,3)	$0,75 \pm 0,05 (V_4/V_n)$	1300 ± 20	1312	112
4a – two-phase asymmetrical fault (P > 0,9)	$0,75 \pm 0,05 (V_4/V_n)$	1300 ± 20	1312	123
5 – LV two-phase asymmetrical fault (P = 0,1 - 0,3)	$0,10 \pm 0,05 (V_5/V_n)$	200 +20	209	0
5 – LV two-phase asymmetrical fault (P > 0,9)	$0,10 \pm 0,05 (V_5/V_n)$	200 +20	209	0
6 – LV two-phase asymmetrical fault (P = 0,1 - 0,3)	$0,50 \pm 0,05 (V_6/V_n)$	850 +20	860	0
6 – LV two-phase asymmetrical fault (P > 0,9)	$0,50 \pm 0,05 (V_6/V_n)$	850 +20	860	0

CEI 0-21				
Clause	Requirement - Test	Result - Remark		Verdict
7– HV three-phase symmetrical fault (P = 0,1 - 0,3)	$1,20 \pm 0,05 (V_7/V_n)$	500 +20	510	155
7– HV three-phase symmetrical fault (P > 0,9)	$1,20 \pm 0,05 (V_7/V_n)$	500 +20	510	124
8– HV three-phase symmetrical fault (P = 0,1 - 0,3)	$1,25 \pm 0,05 (V_8/V_n)$	100 +20	110	152
8– HV three-phase symmetrical fault (P > 0,9)	$1,25 \pm 0,05 (V_8/V_n)$	100 +20	110	138
Note: The interface protection shall be disabled or adjusted to avoid spurious tripping during testing. The test conditions are performed as worst case conditions. The inverter feeds maximal active and reactive power during the complete test.				

CEI 0-21			
Clause	Requirement - Test	Result - Remark	Verdict

Test 1s-Depth of fault phase: 0.1p.u.,three-phase-symmetrical (type A), 0% load
 Test overview(voltage,current,active and reactive power)

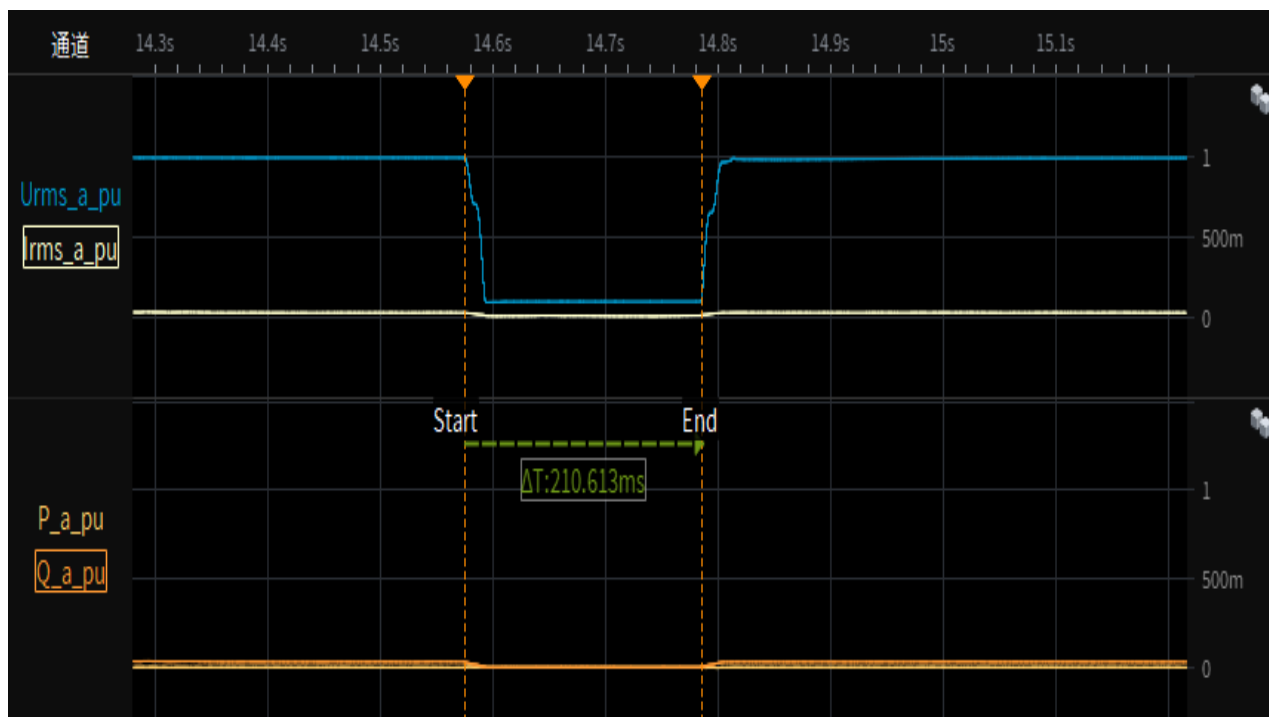

Test 1s-1.1 Depth of fault phase: 0.1p.u.,three-phase-symmetrical (type A),20% load
 Test overview(voltage,current,active and reactive power)

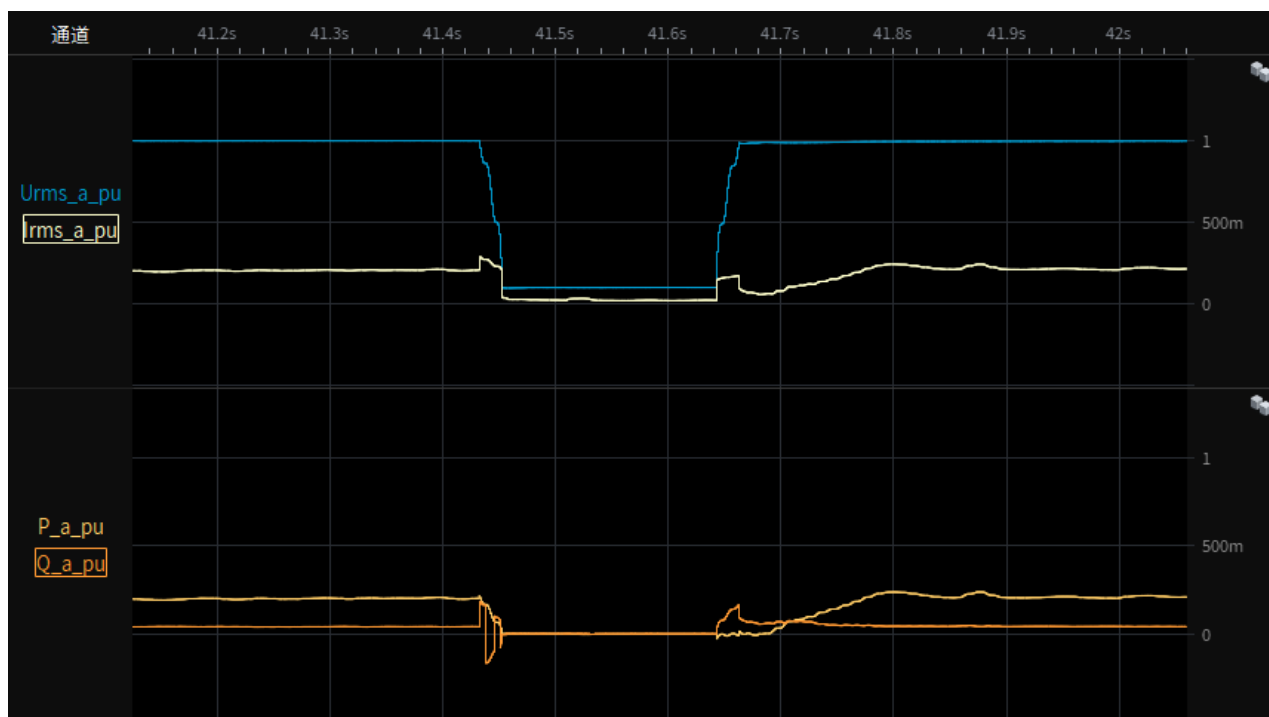

CEI 0-21			
Clause	Requirement - Test	Result - Remark	Verdict

Test 1s-1.2 Depth of fault phase: 0.1p.u.,three-phase-symmetrical (type A),20% load
Instantaneous curve and RMS value of phase-to-neutral voltages

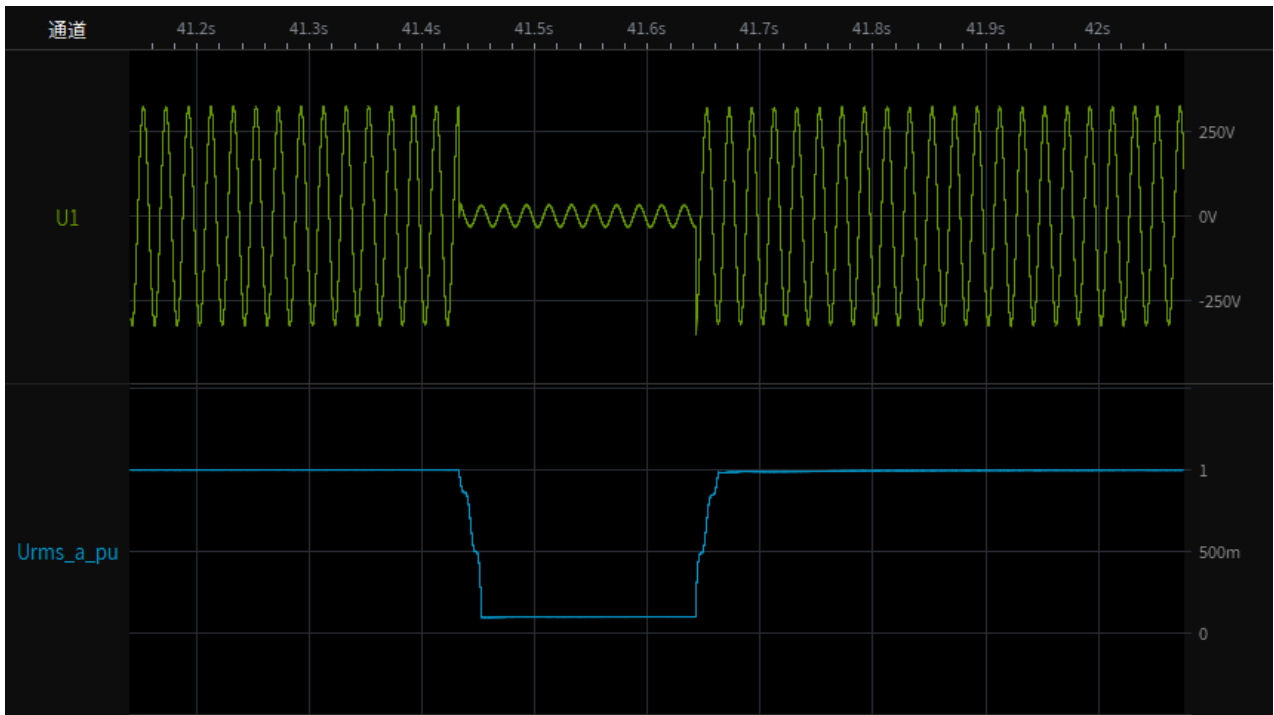

Test 1s-1.3 Depth of fault phase: 0.1p.u.,three-phase-symmetrical (type A),20% load
Instantaneous curve and RMS value of phase currents

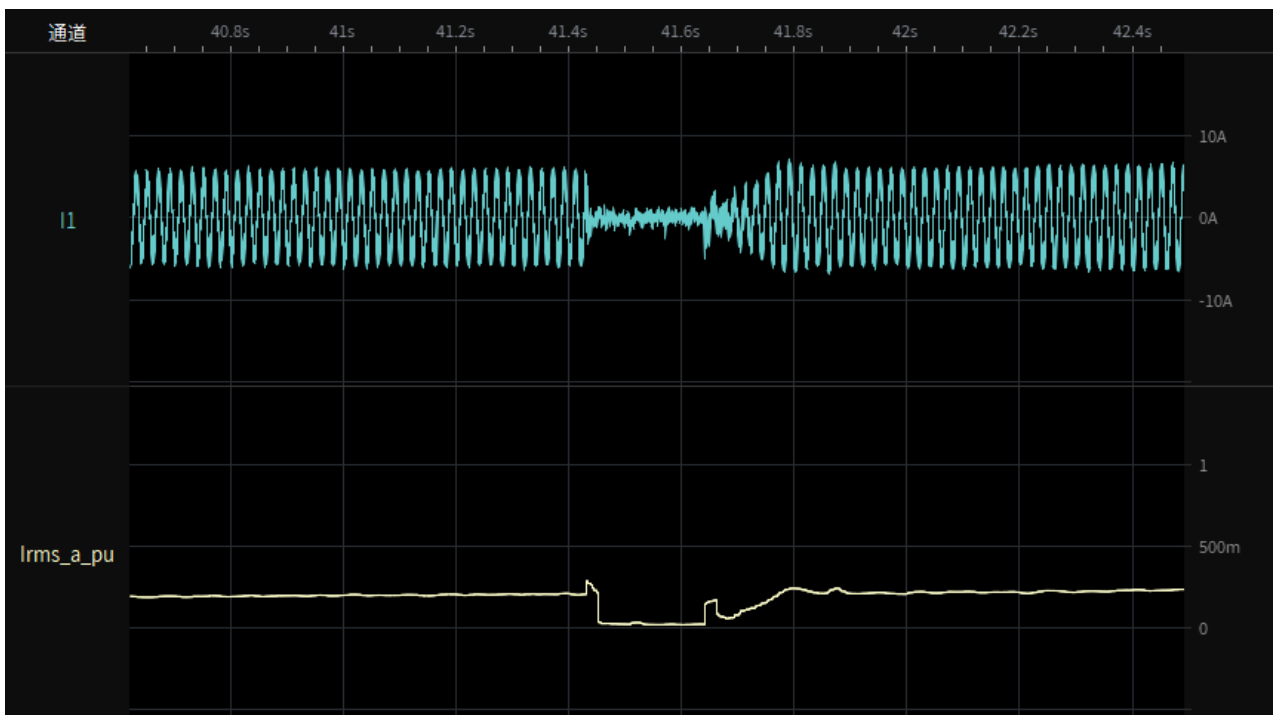

CEI 0-21			
Clause	Requirement - Test	Result - Remark	Verdict

Test 1s-1.4 Depth of fault phase: 0.1p.u.,three-phase-symmetrical (type A),20% load restoring time



Test 1s-2.1 Depth of fault phase: 0.1p.u.,three-phase-symmetrical (type A),95% load Test overview(voltage,current,active and reactive power)

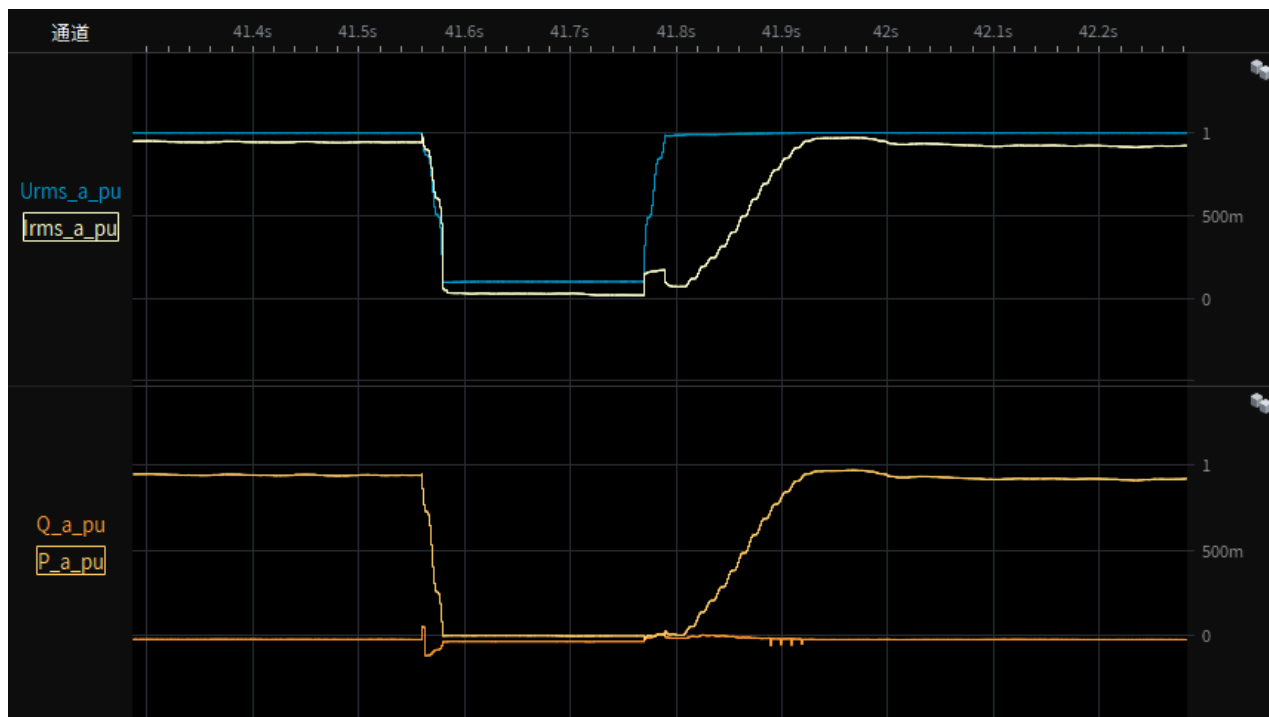

CEI 0-21			
Clause	Requirement - Test	Result - Remark	Verdict

Test 1s-2.2 Depth of fault phase: 0.1p.u.,three-phase-symmetrical (type A),95% load
Instantaneous curve and RMS value of phase-to-neutral voltages

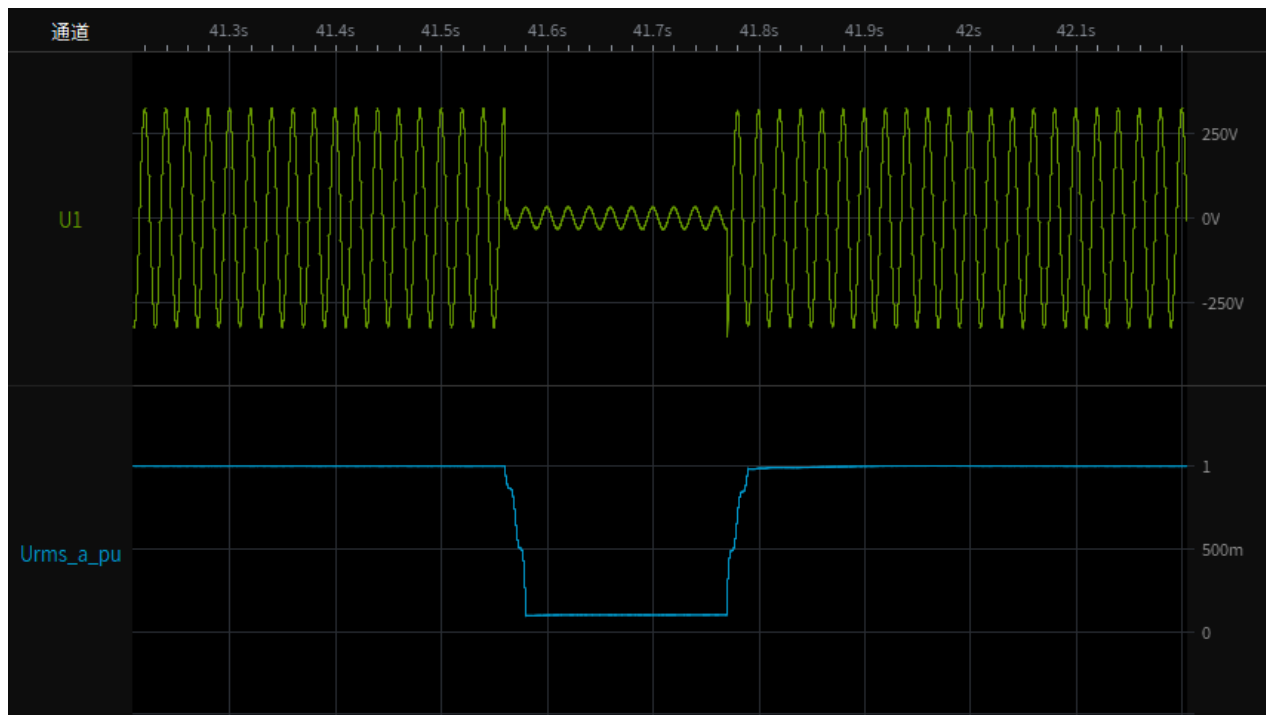

Test 1s-2.3 Depth of fault phase: 0.1p.u.,three-phase-symmetrical (type A),95% load
Instantaneous curve and RMS value of phase currents

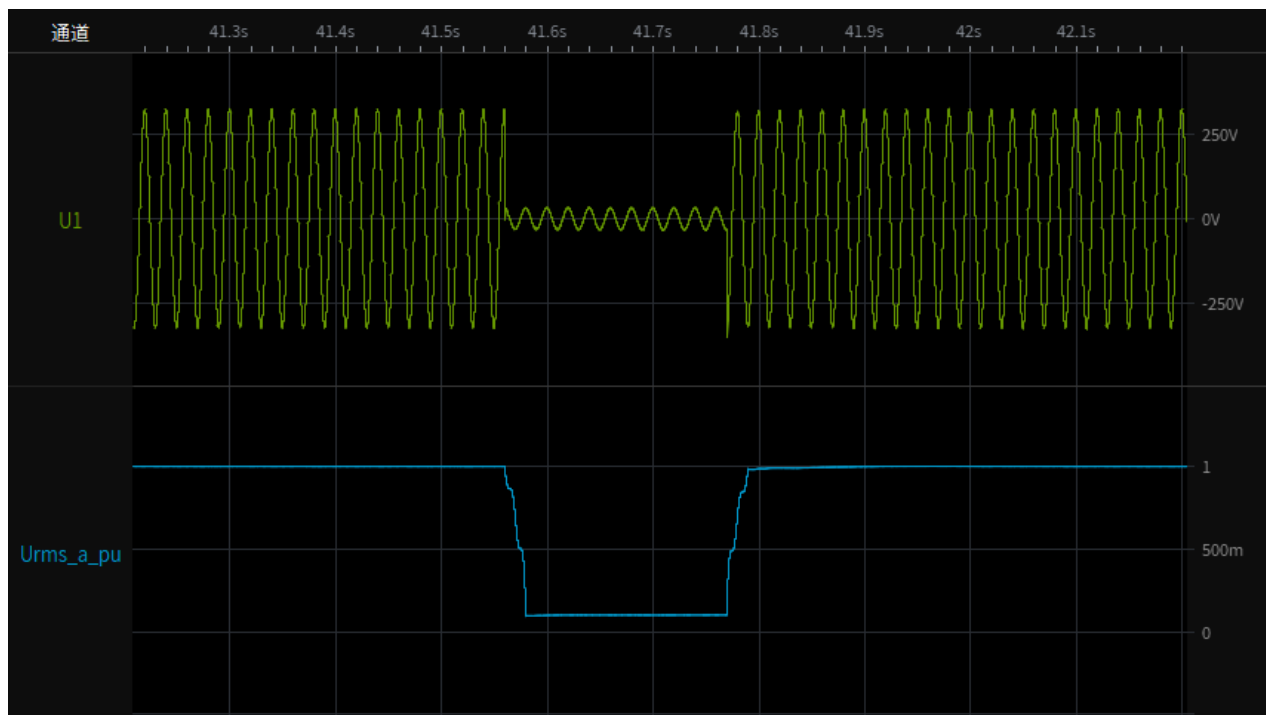

CEI 0-21			
Clause	Requirement - Test	Result - Remark	Verdict

Test 1s-2.4 Depth of fault phase: 0.1p.u.,three-phase-symmetrical (type A), 95% load restoring time

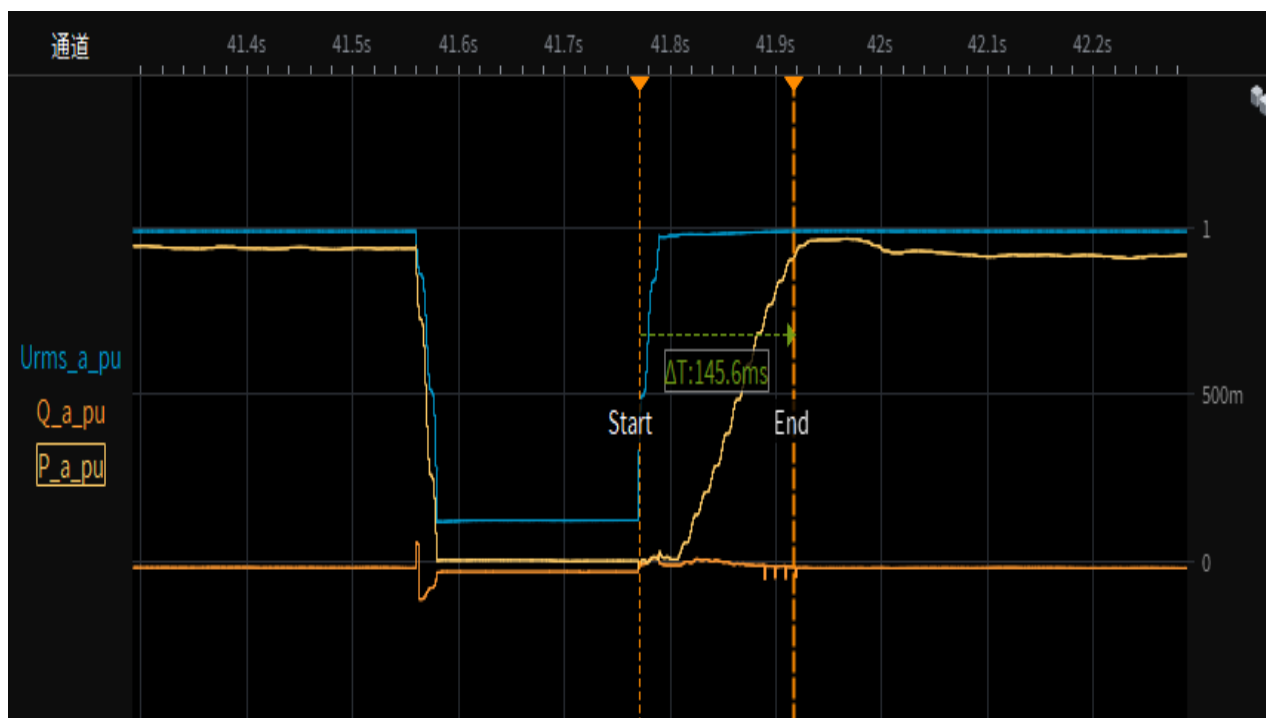

Test 1a-Depth of fault phase: 0.1p.u.,two-phase-asymmetrical (type D), 0% load Test overview(voltage,current,active and reactive power)

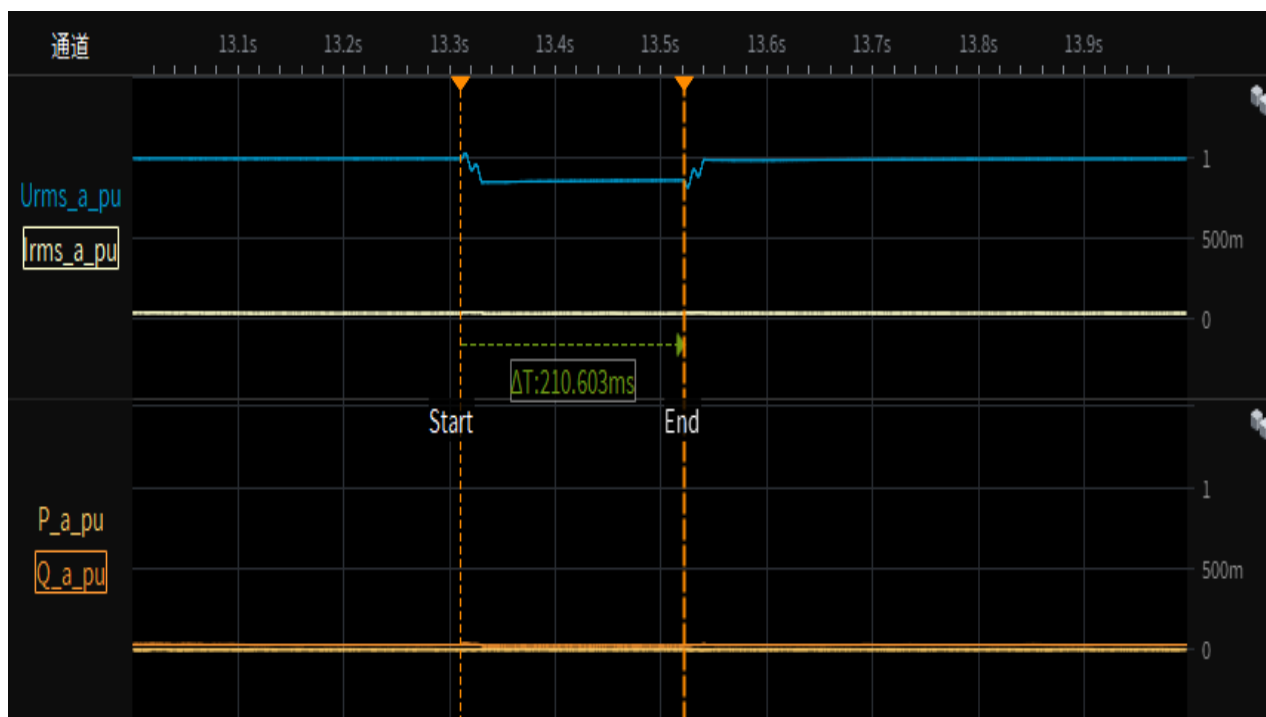

CEI 0-21			
Clause	Requirement - Test	Result - Remark	Verdict

Test 1a-1.1 Depth of fault phase: 0.1p.u., two-phase-asymmetrical (type D),20% load
Test overview(voltage,current,active and reactive power)

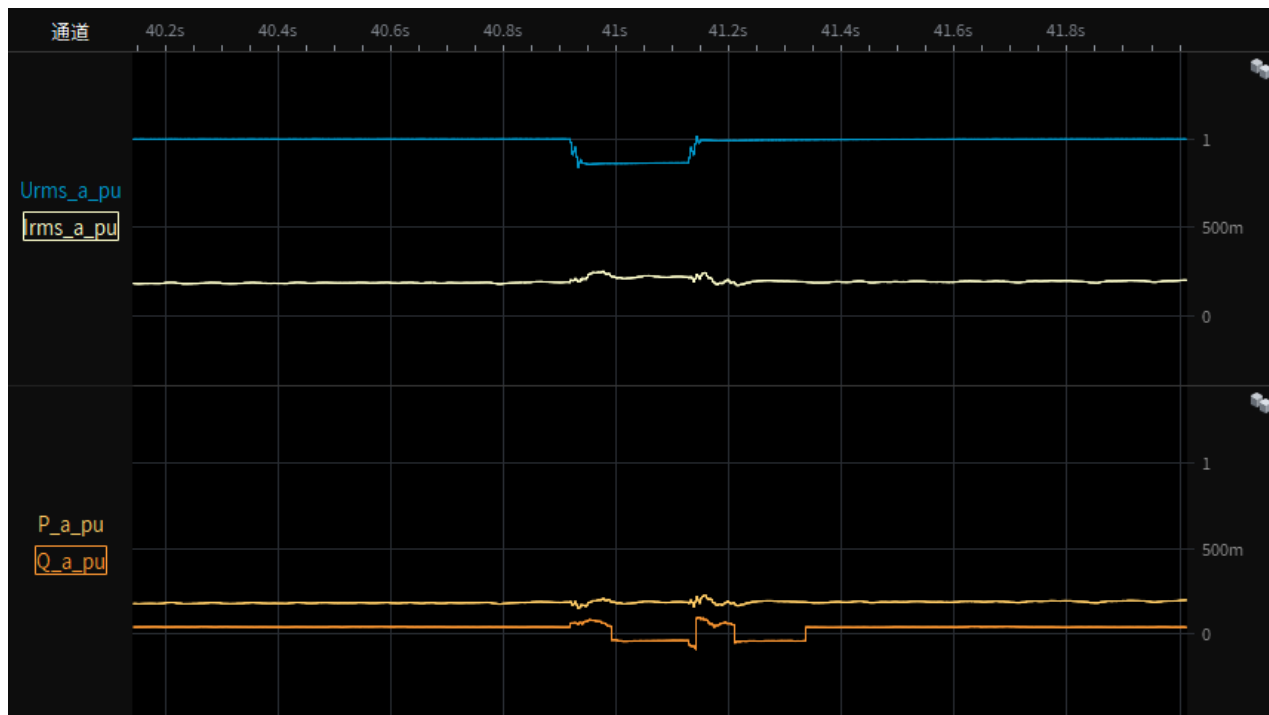

Test 1a-1.2 Depth of fault phase: 0.1p.u., two-phase-asymmetrical (type D),20% load
Instantaneous curve and RMS value of phase-to-neutral voltages

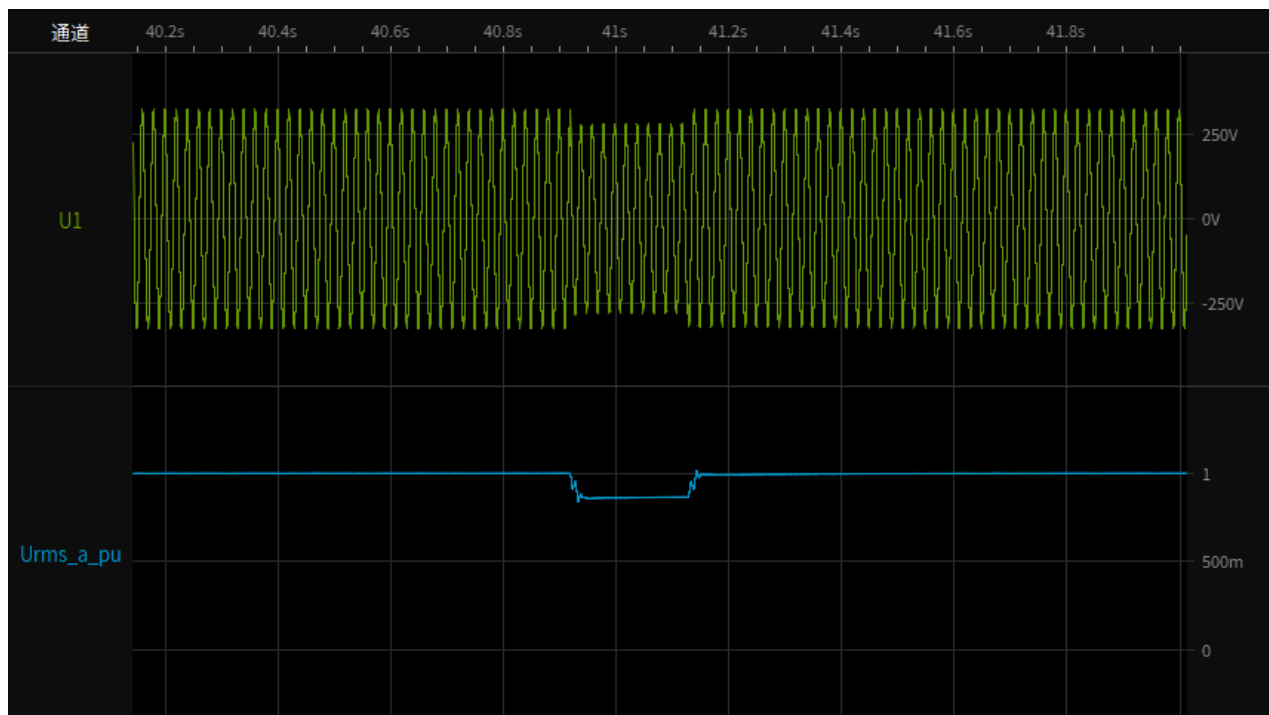

CEI 0-21			
Clause	Requirement - Test	Result - Remark	Verdict

Test 1a-1.3 Depth of fault phase: 0.1p.u., two-phase-asymmetrical (type D),20% load
Instantaneous curve and RMS value of phase currents

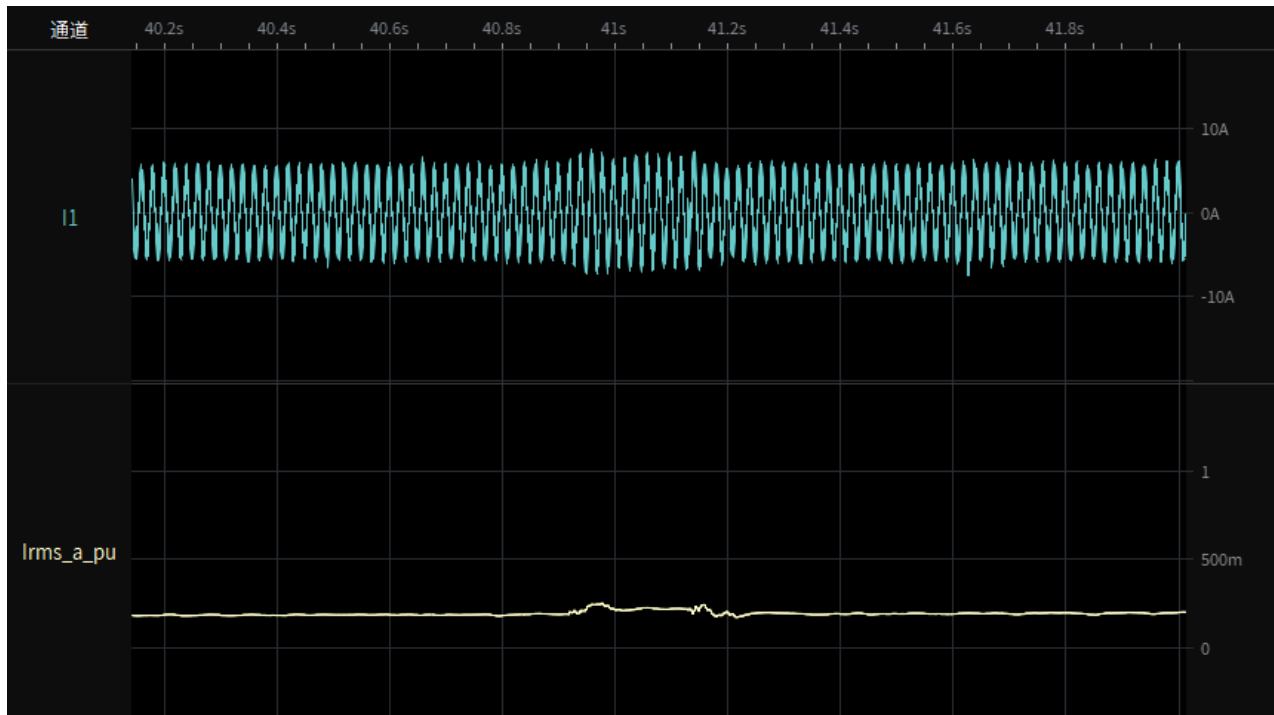

Test 1a-1.4 Depth of fault phase: 0.1p.u., two-phase-asymmetrical (type D),20% load
restoring time

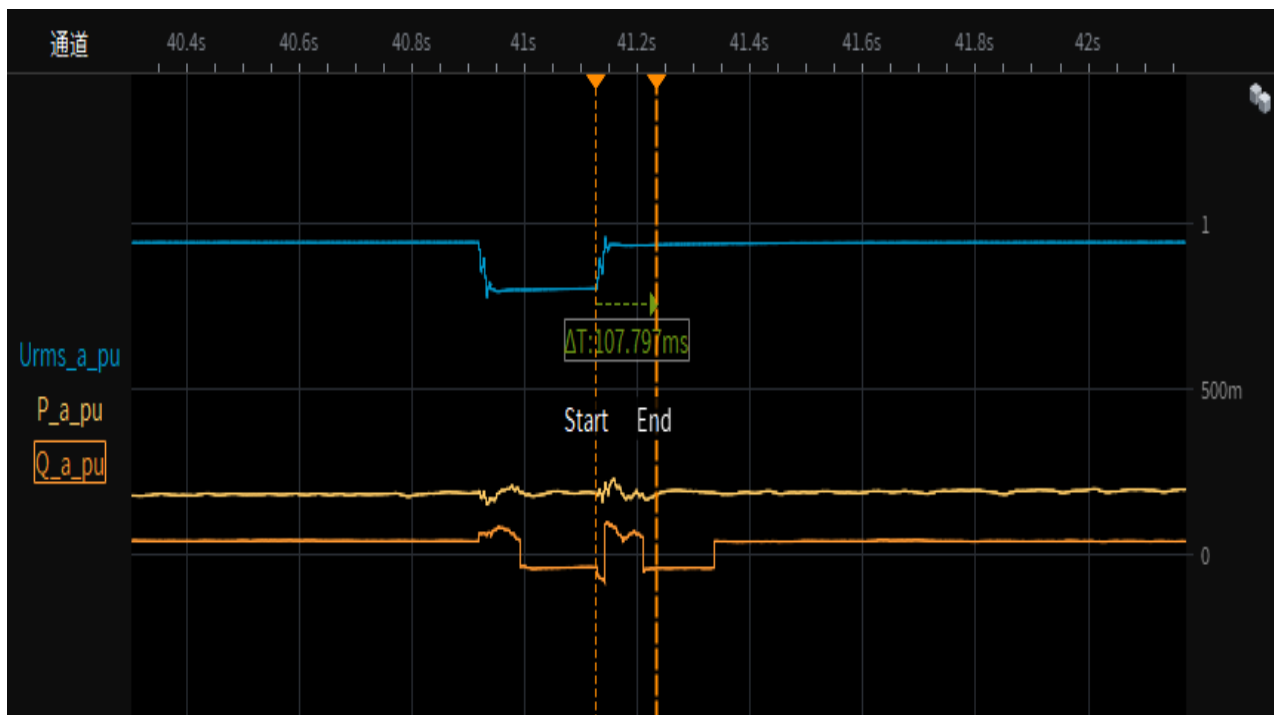

CEI 0-21			
Clause	Requirement - Test	Result - Remark	Verdict

Test 1a-2.1 Depth of fault phase: 0.1p.u., two-phase-asymmetrical (type D),95% load
Test overview(voltage,current,active and reactive power)

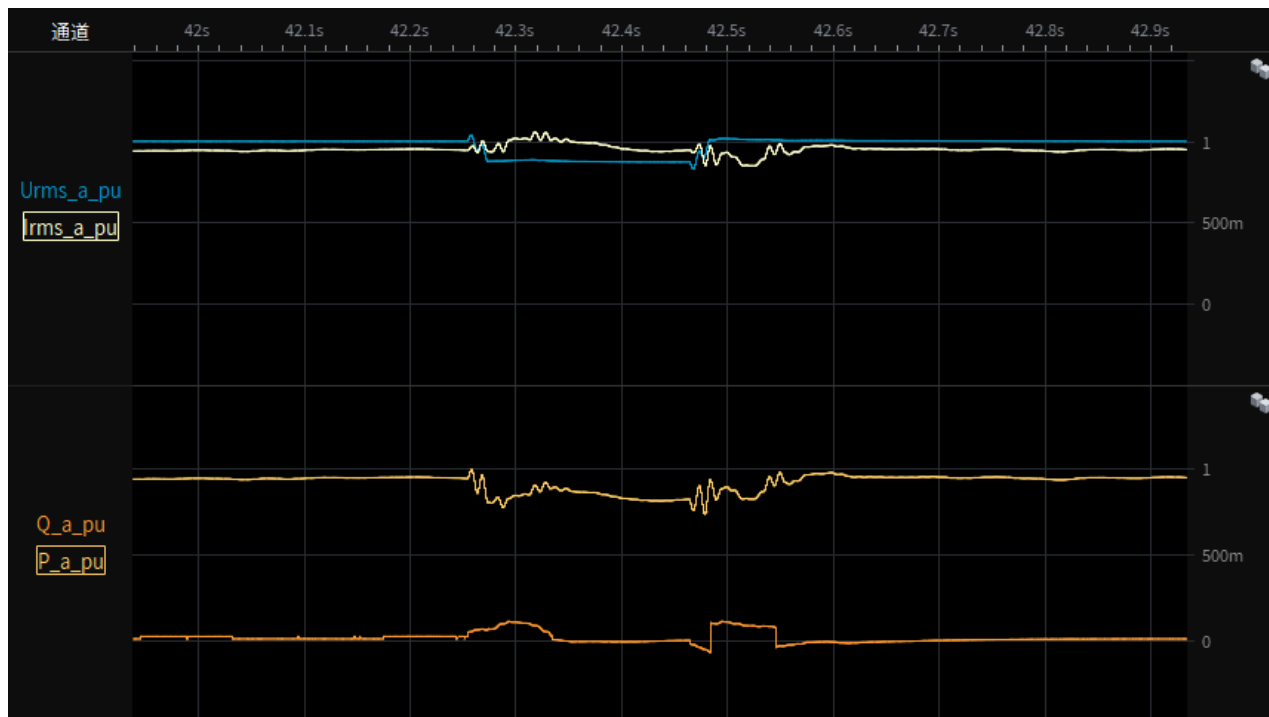

Test 1a-2.2 Depth of fault phase: 0.1p.u., two-phase-asymmetrical (type D),95% load
Instantaneous curve and RMS value of phase-to-neutral voltages

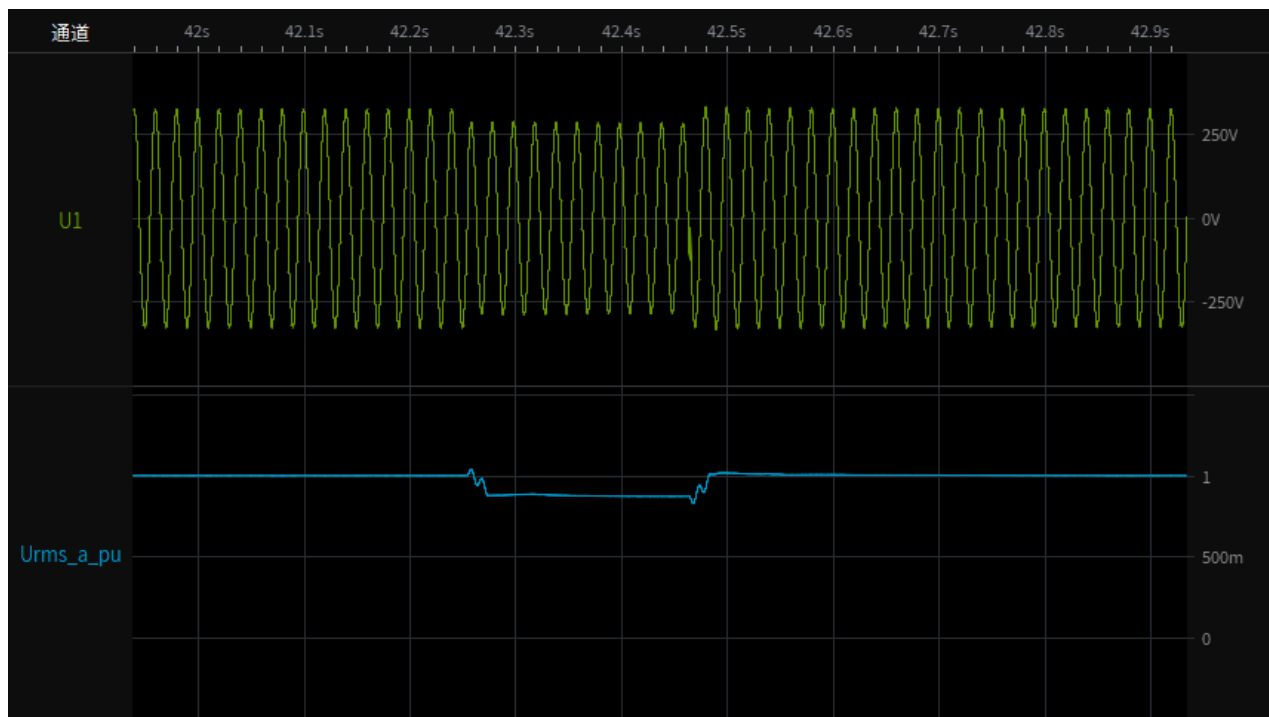

CEI 0-21			
Clause	Requirement - Test	Result - Remark	Verdict

Test 1a-2.3 Depth of fault phase: 0.1p.u., two-phase-asymmetrical (type D),95% load
Instantaneous curve and RMS value of phase currents

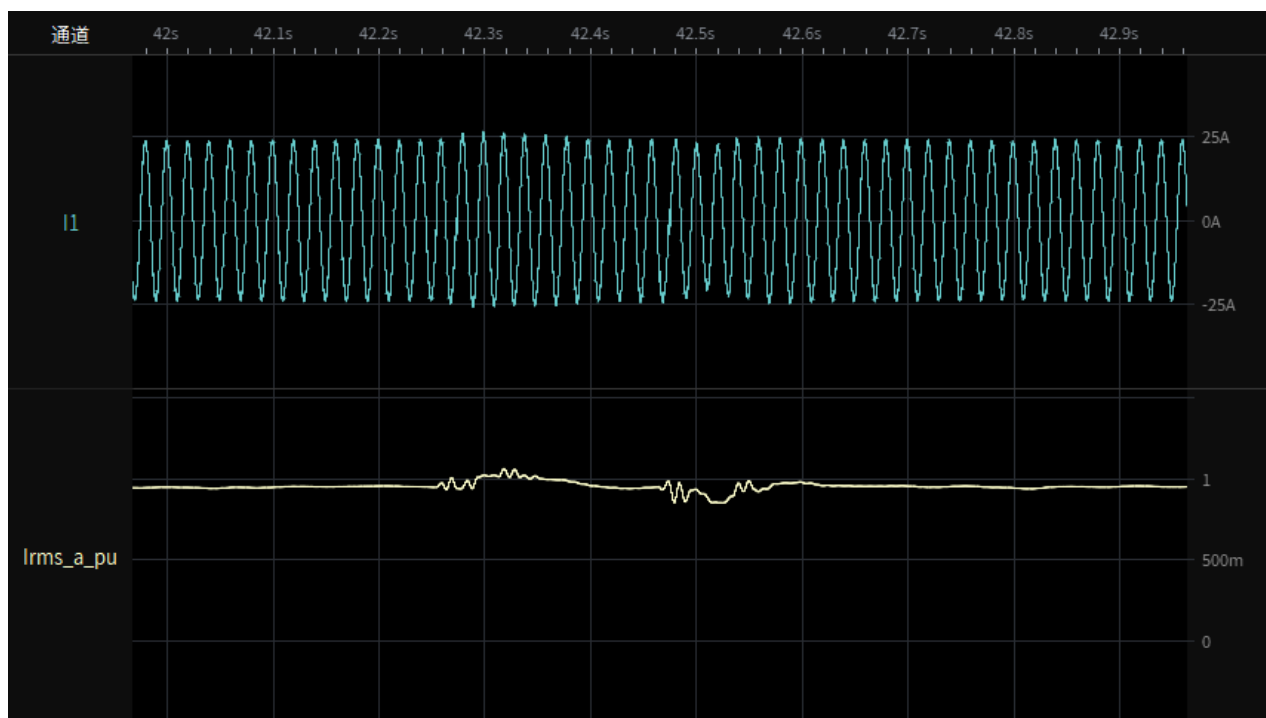

Test 1a-2.4 Depth of fault phase: 0.1p.u., two-phase-asymmetrical (type D), 95% load
restoring time



CEI 0-21			
Clause	Requirement - Test	Result - Remark	Verdict

Test 2s-Depth of fault phase: 0.25p.u.,three-phase-symmetrical (type A), 0% load
Test overview(voltage,current,active and reactive power)

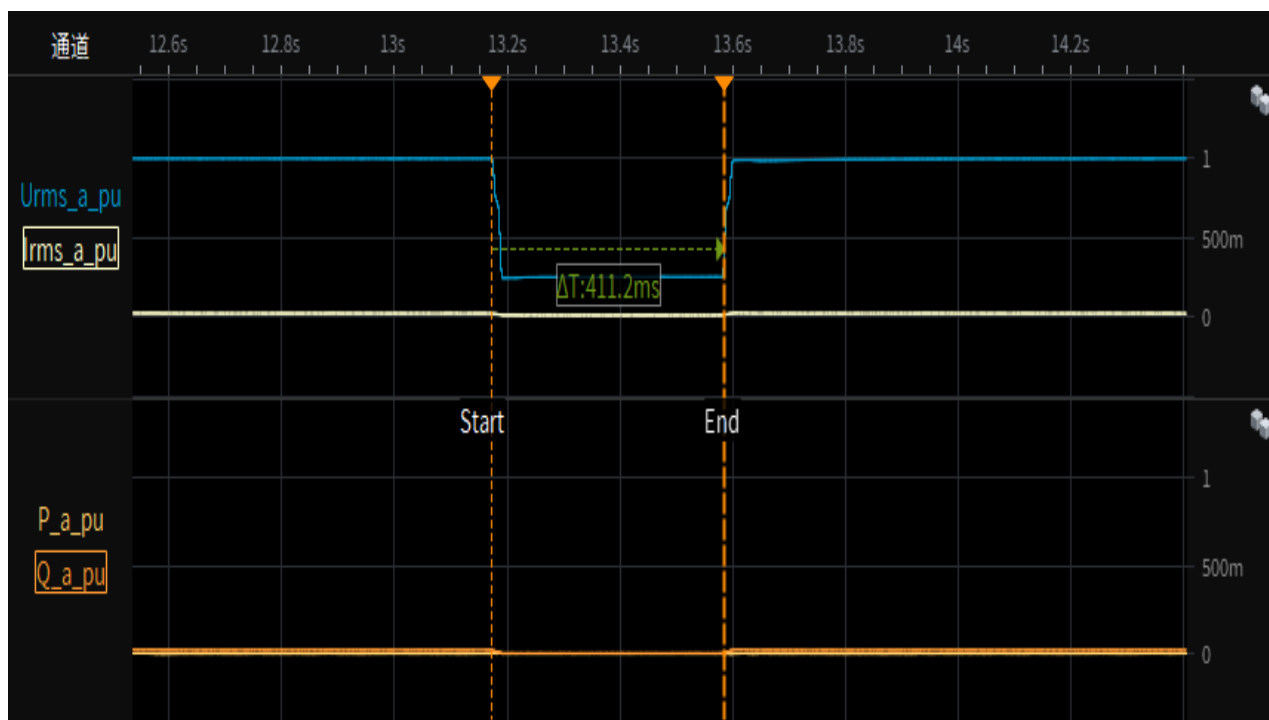

Test 2s-1.1 Depth of fault phase: 0.25p.u.,three-phase-symmetrical (type A),20% load
Test overview(voltage,current,active and reactive power)

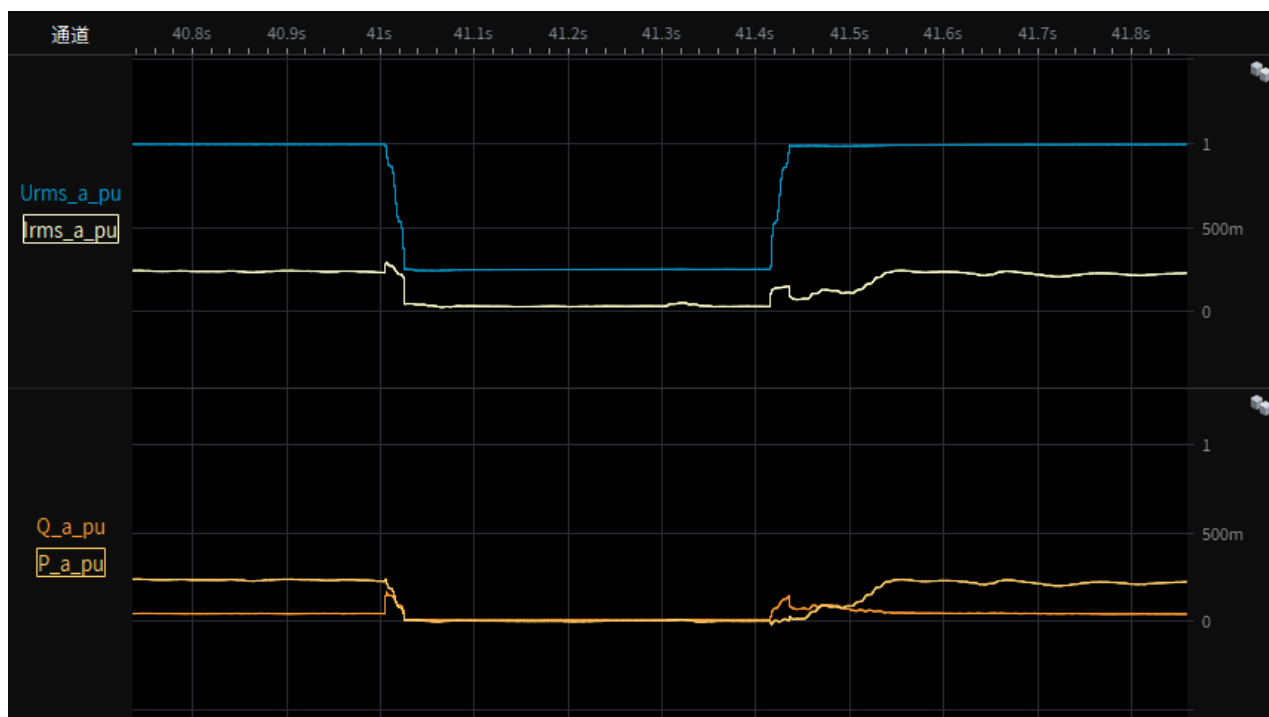

CEI 0-21			
Clause	Requirement - Test	Result - Remark	Verdict

Test 2s-1.2 Depth of fault phase: 0.25p.u.,three-phase-symmetrical (type A),20% load
Instantaneous curve and RMS value of phase-to-neutral voltages

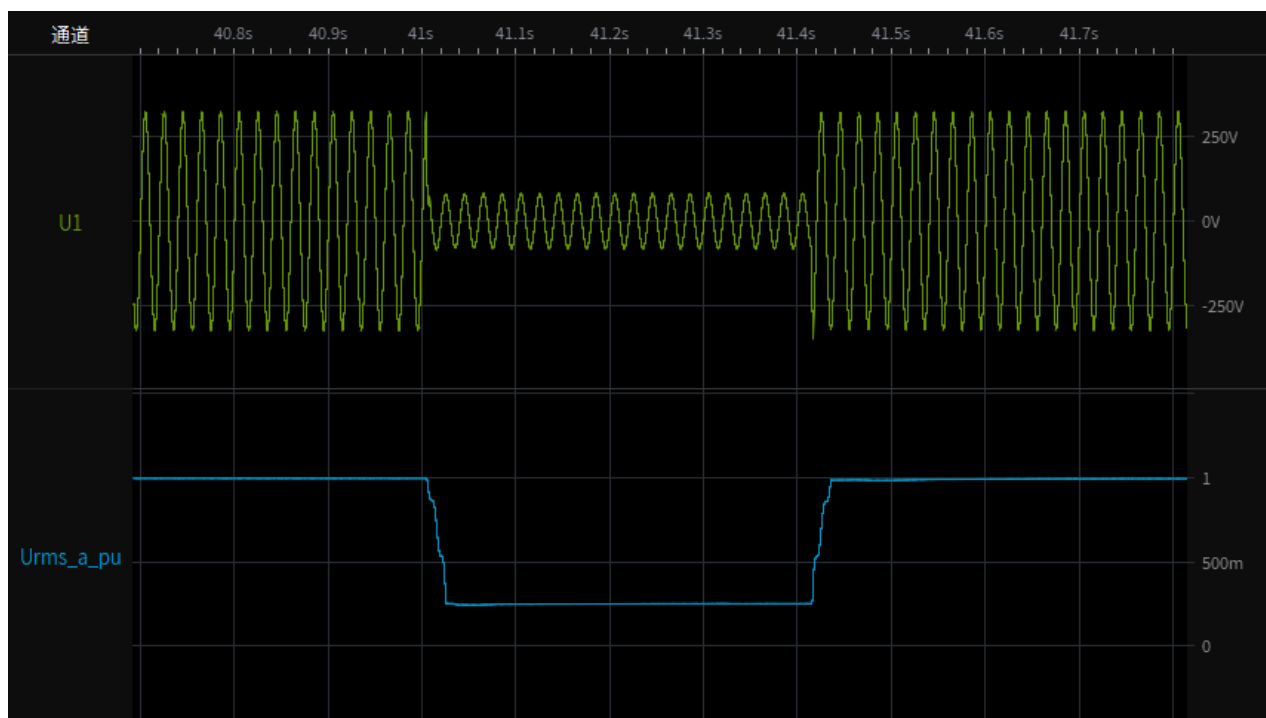

Test 2s-1.3 Depth of fault phase: 0.25p.u.,three-phase-symmetrical (type A),20% load
Instantaneous curve and RMS value of phase currents

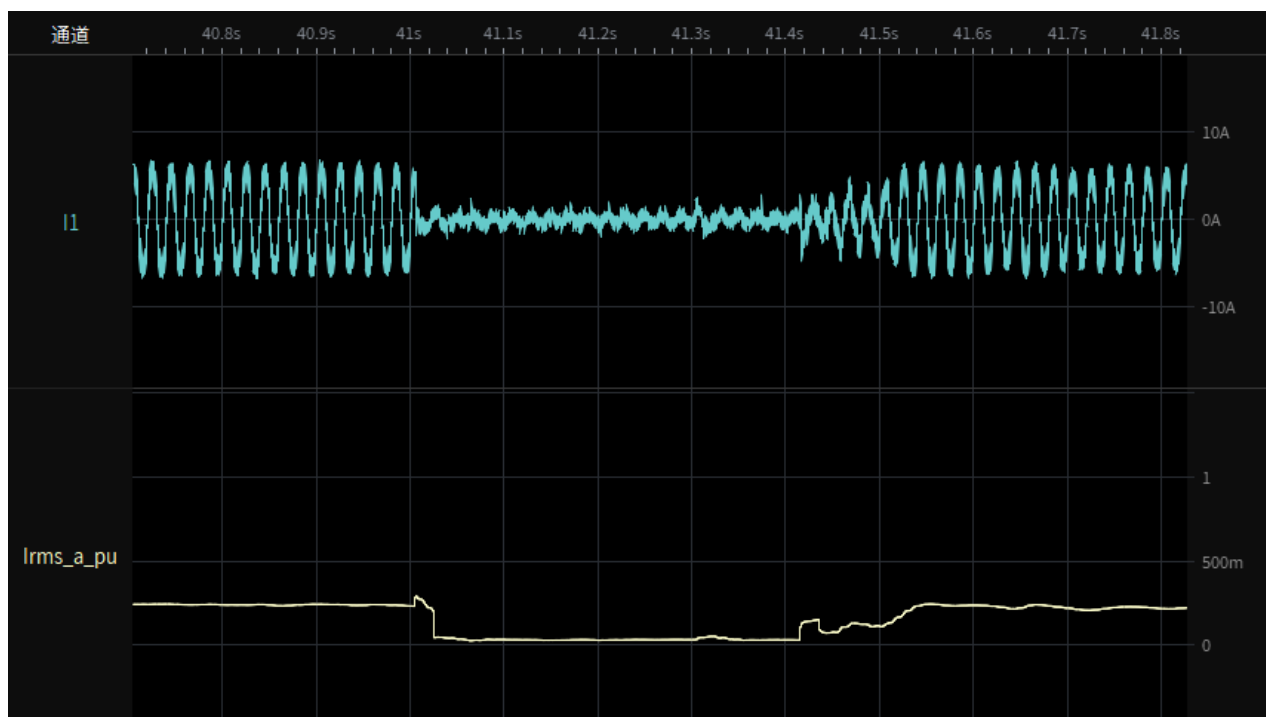

CEI 0-21			
Clause	Requirement - Test	Result - Remark	Verdict

Test 2s-1.4 Depth of fault phase: 0.25p.u.,three-phase-symmetrical (type A),20% load restoring time

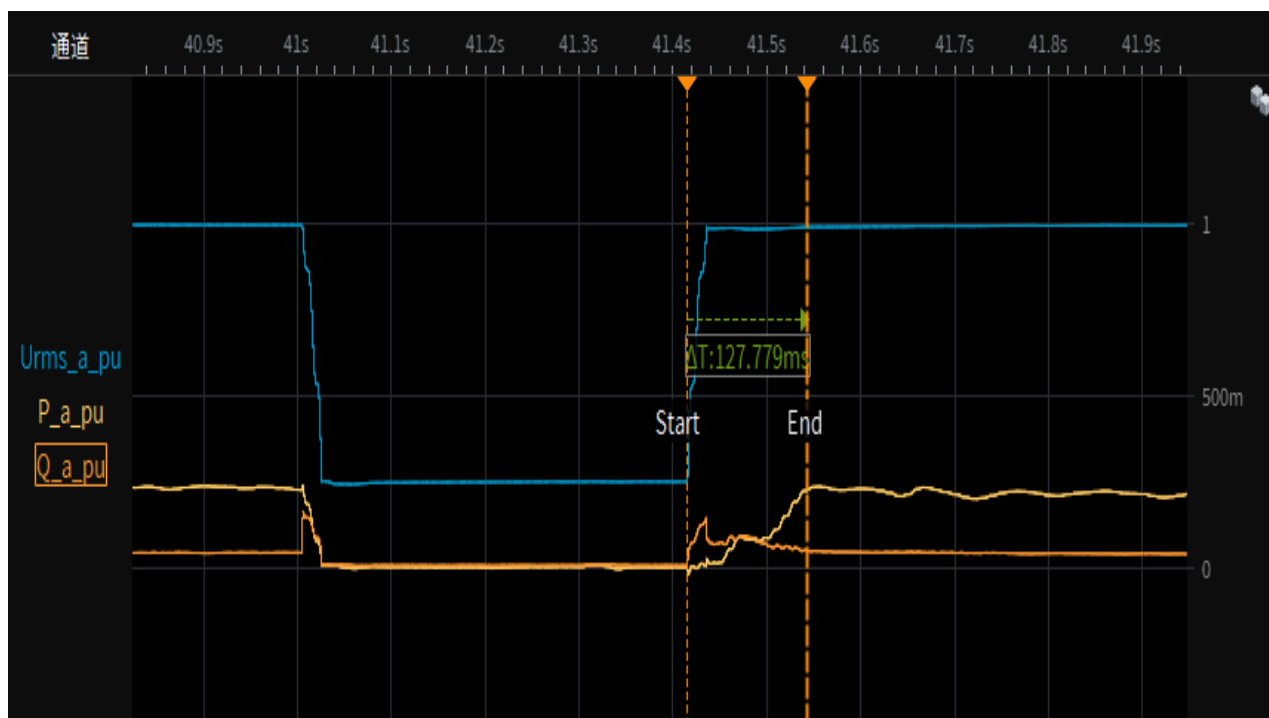

Test 2s-2.1 Depth of fault phase: 0.25p.u.,three-phase-symmetrical (type A),95% load Test overview(voltage,current,active and reactive power)

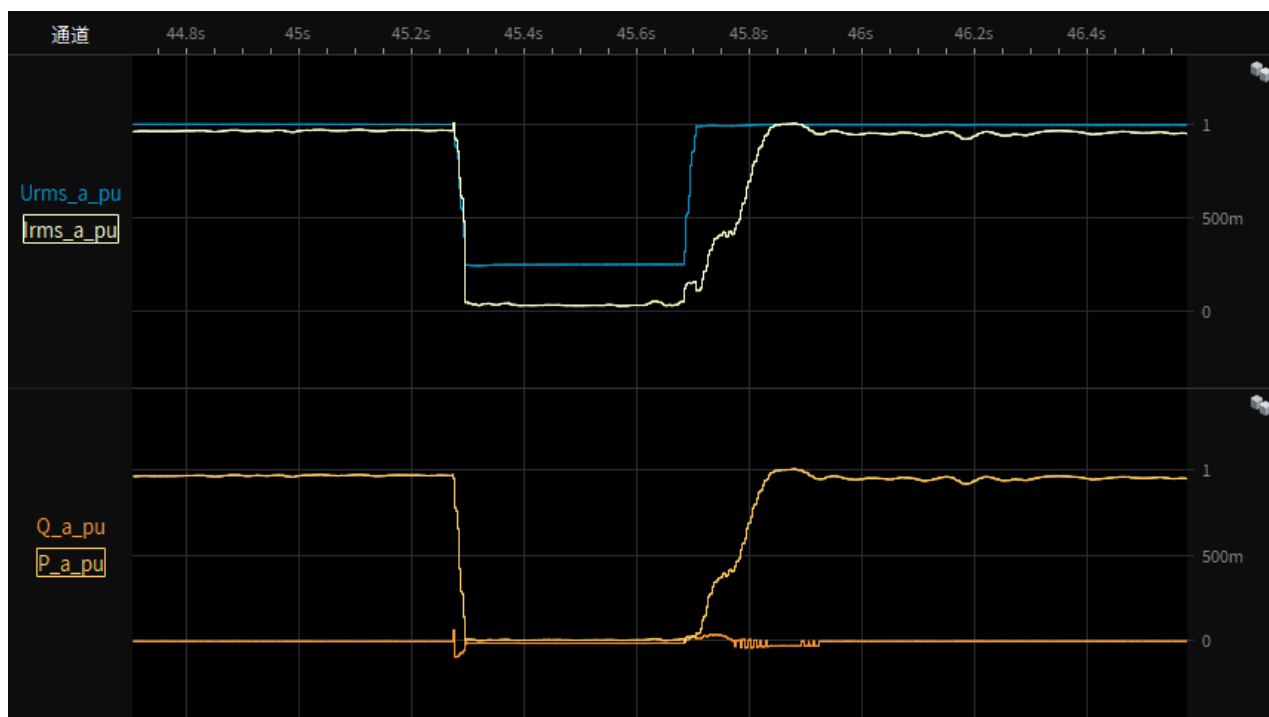

CEI 0-21			
Clause	Requirement - Test	Result - Remark	Verdict

Test 2s-2.2 Depth of fault phase: 0.25p.u.,three-phase-symmetrical (type A),95% load
Instantaneous curve and RMS value of phase-to-neutral voltages

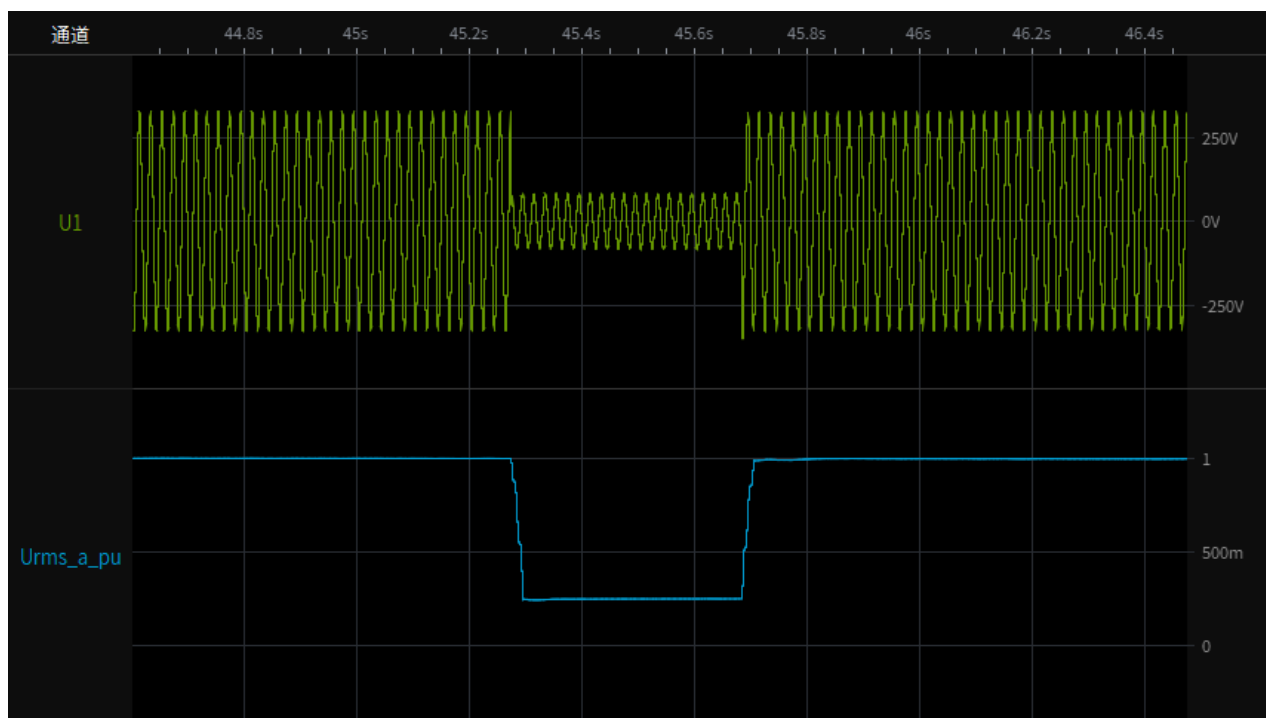

Test 2s-2.3 Depth of fault phase: 0.25p.u.,three-phase-symmetrical (type A),95% load
Instantaneous curve and RMS value of phase currents

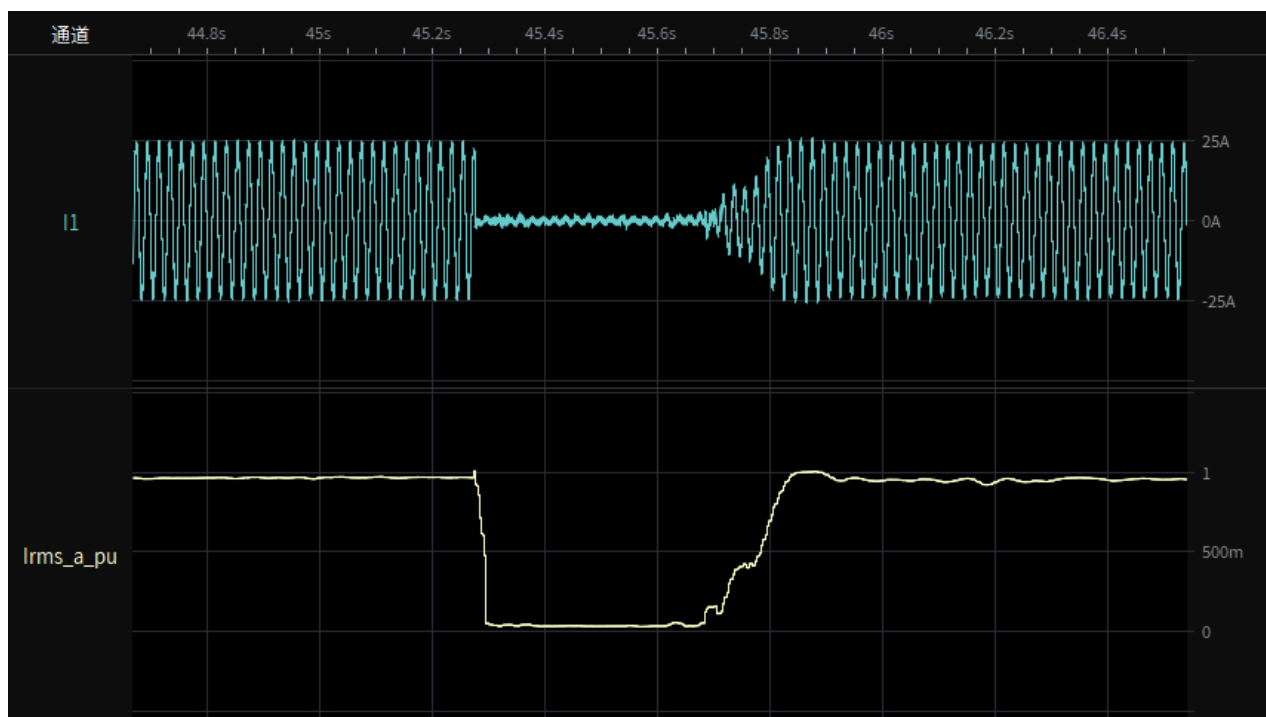

CEI 0-21			
Clause	Requirement - Test	Result - Remark	Verdict

Test 2s-2.4 Depth of fault phase: 0.25p.u.,three-phase-symmetrical (type A), 95% load restoring time

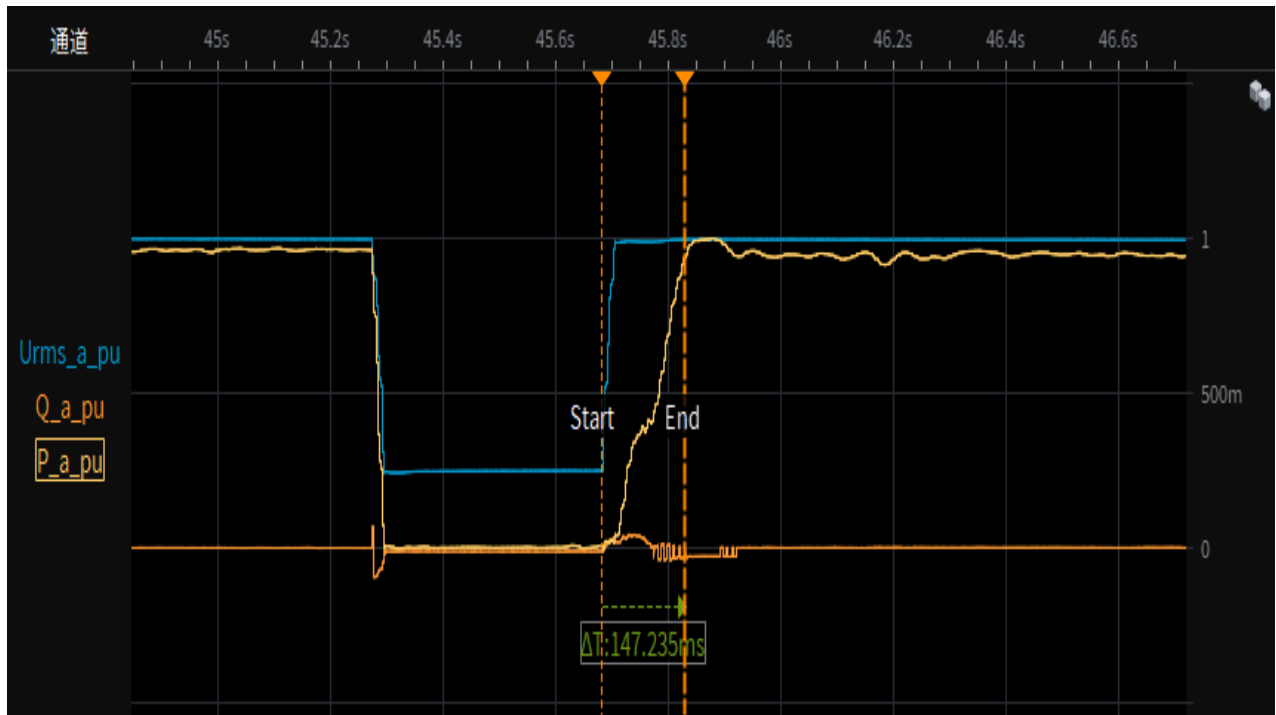

Test 2a-Depth of fault phase: 0.25p.u.,two-phase-asymmetrical (type D), 0% load Test overview(voltage,current,active and reactive power)

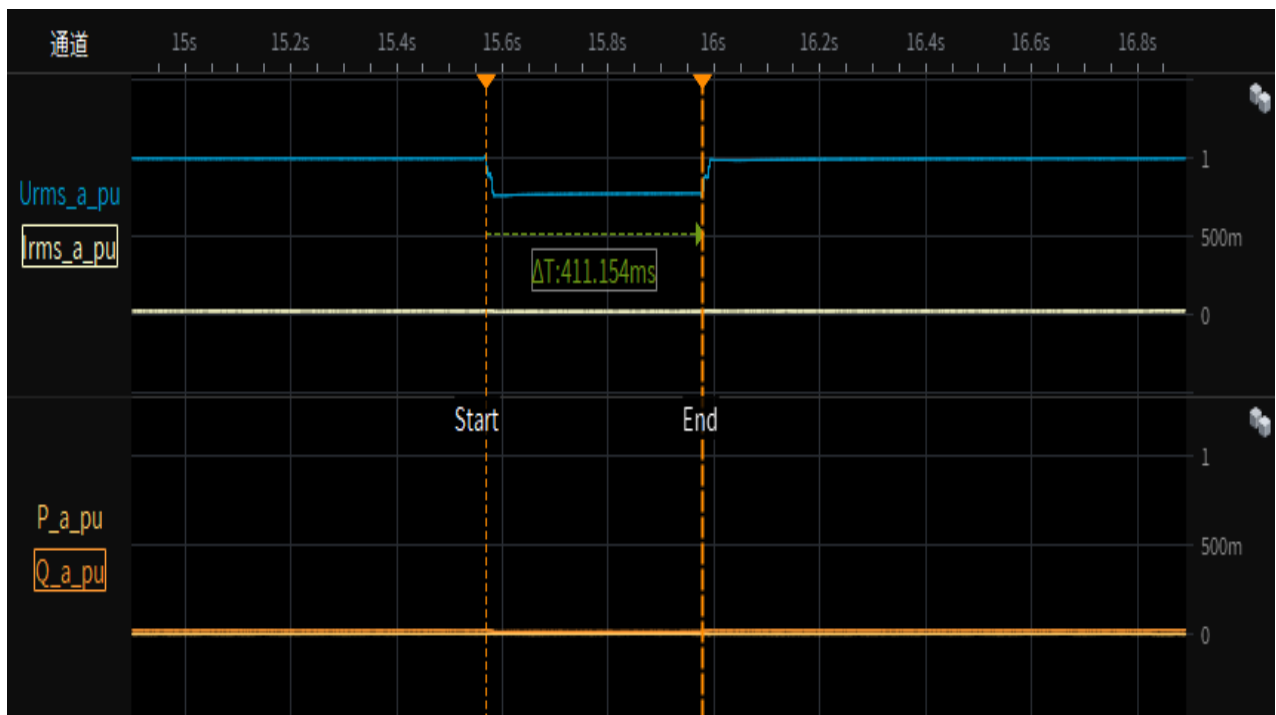

CEI 0-21			
Clause	Requirement - Test	Result - Remark	Verdict

Test 2a-1.1 Depth of fault phase: 0.25p.u.,two-phase-asymmetrical (type D),20% load
Test overview(voltage,current,active and reactive power)

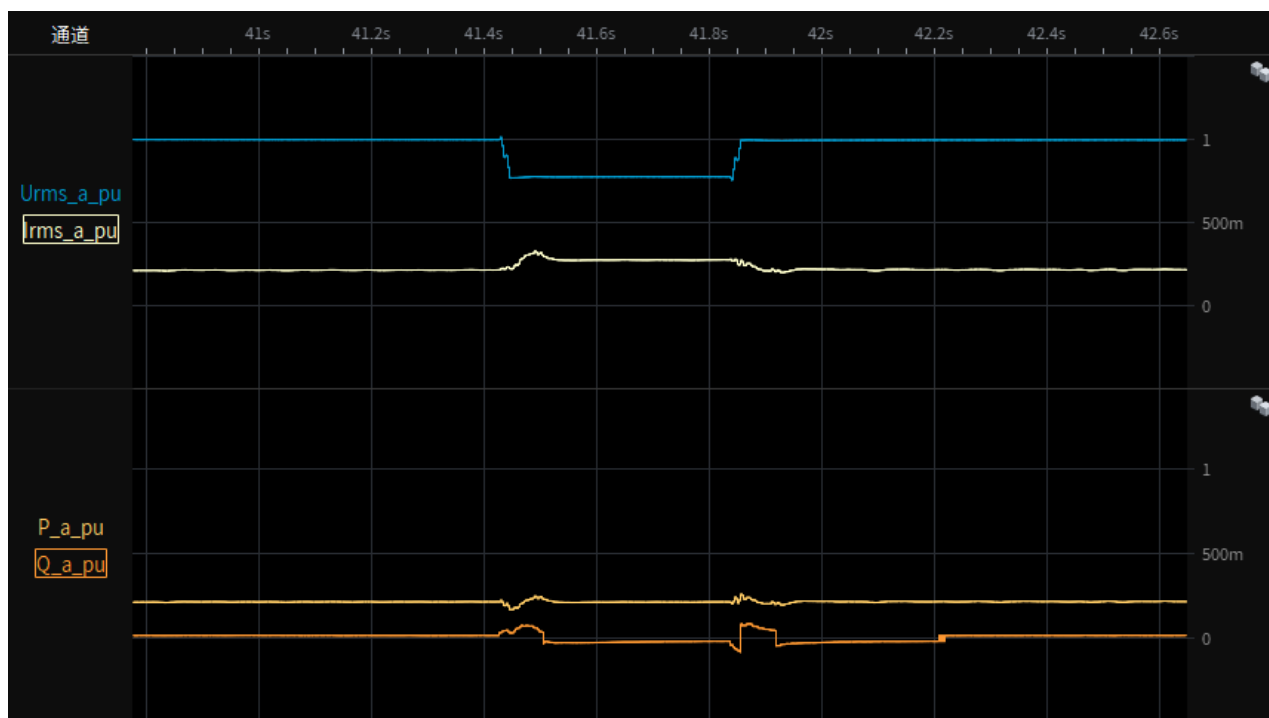

Test 2a-1.2 Depth of fault phase: 0.25p.u.,two-phase-asymmetrical (type D),20% load
Instantaneous curve and RMS value of phase-to-neutral voltages

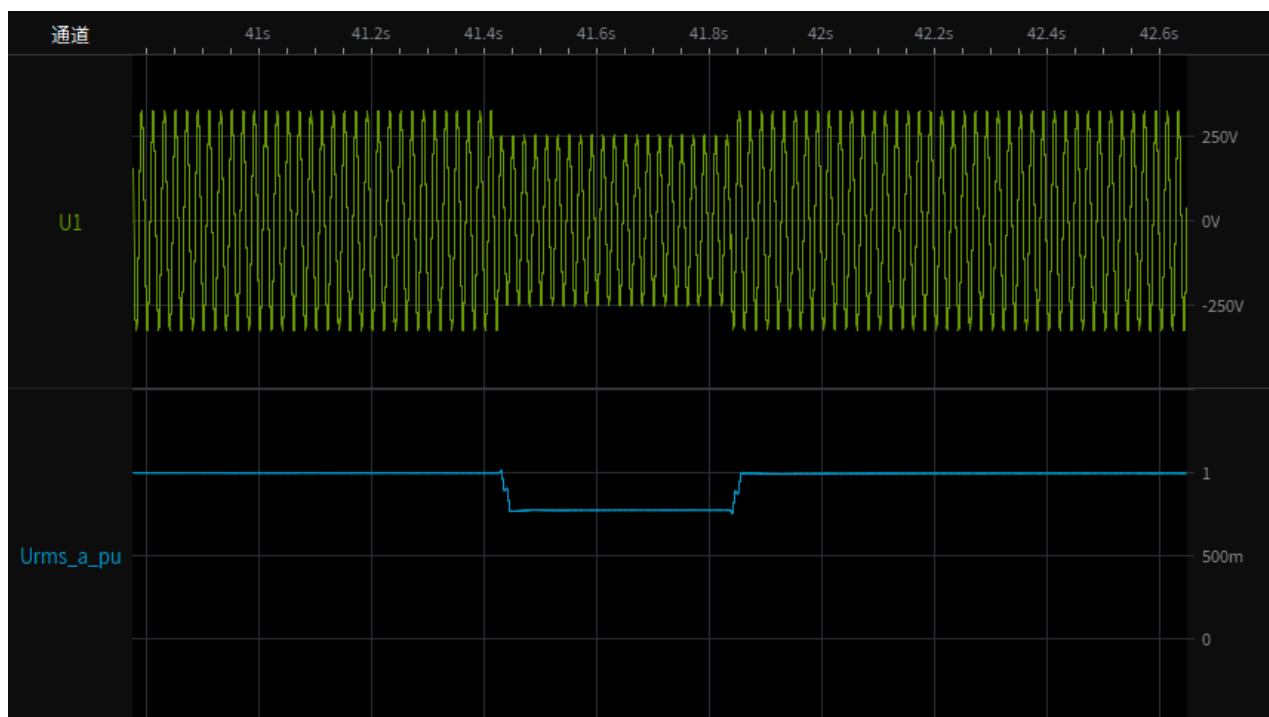

CEI 0-21			
Clause	Requirement - Test	Result - Remark	Verdict

Test 2a-1.3 Depth of fault phase: 0.25p.u., two-phase-asymmetrical (type D), 20% load
Instantaneous curve and RMS value of phase currents

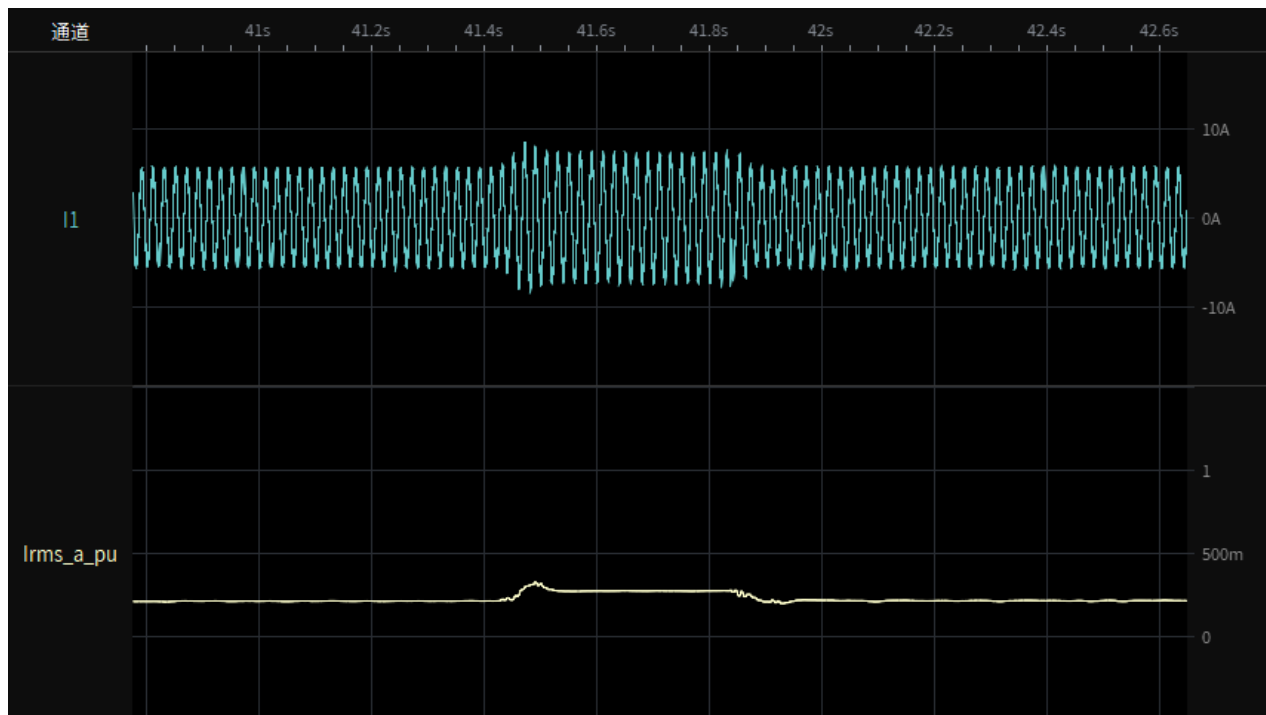

Test 2a-1.4 Depth of fault phase: 0.25p.u., two-phase-asymmetrical (type D), 20% load
restoring time

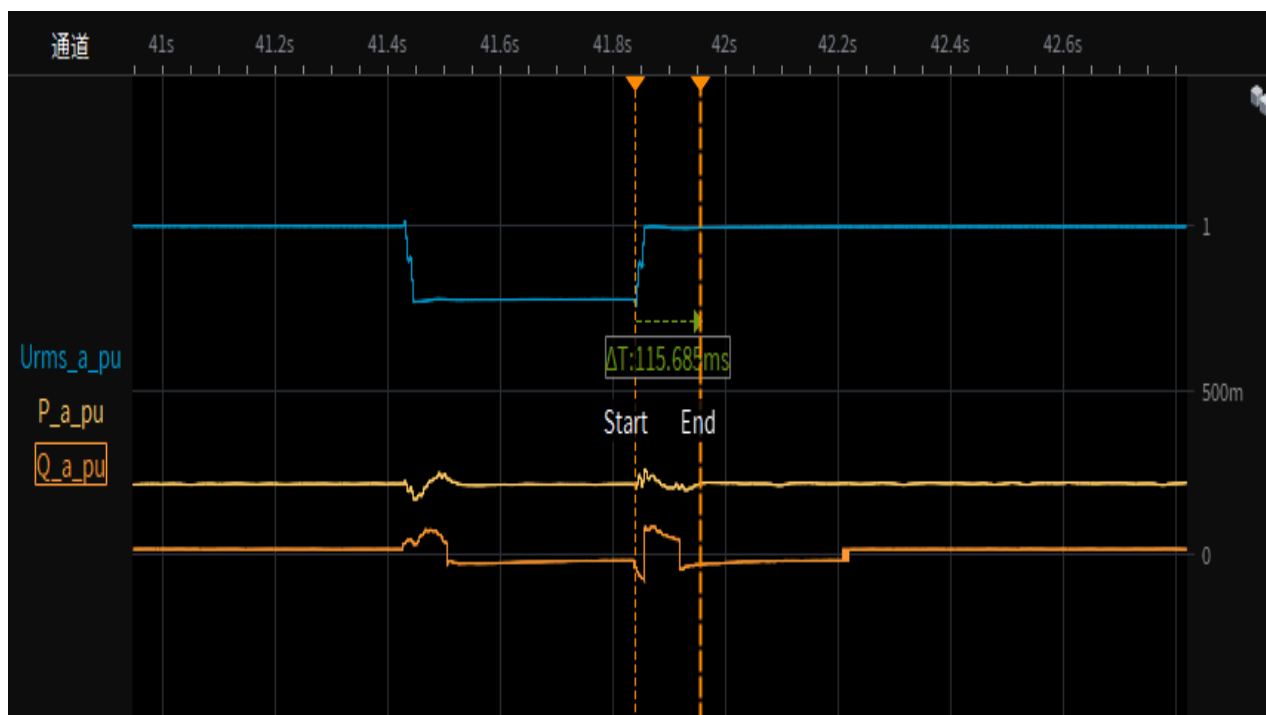

CEI 0-21			
Clause	Requirement - Test	Result - Remark	Verdict

Test 2a-2.1 Depth of fault phase: 0.25p.u.,two-phase-asymmetrical (type D),95% load
Test overview(voltage,current,active and reactive power)

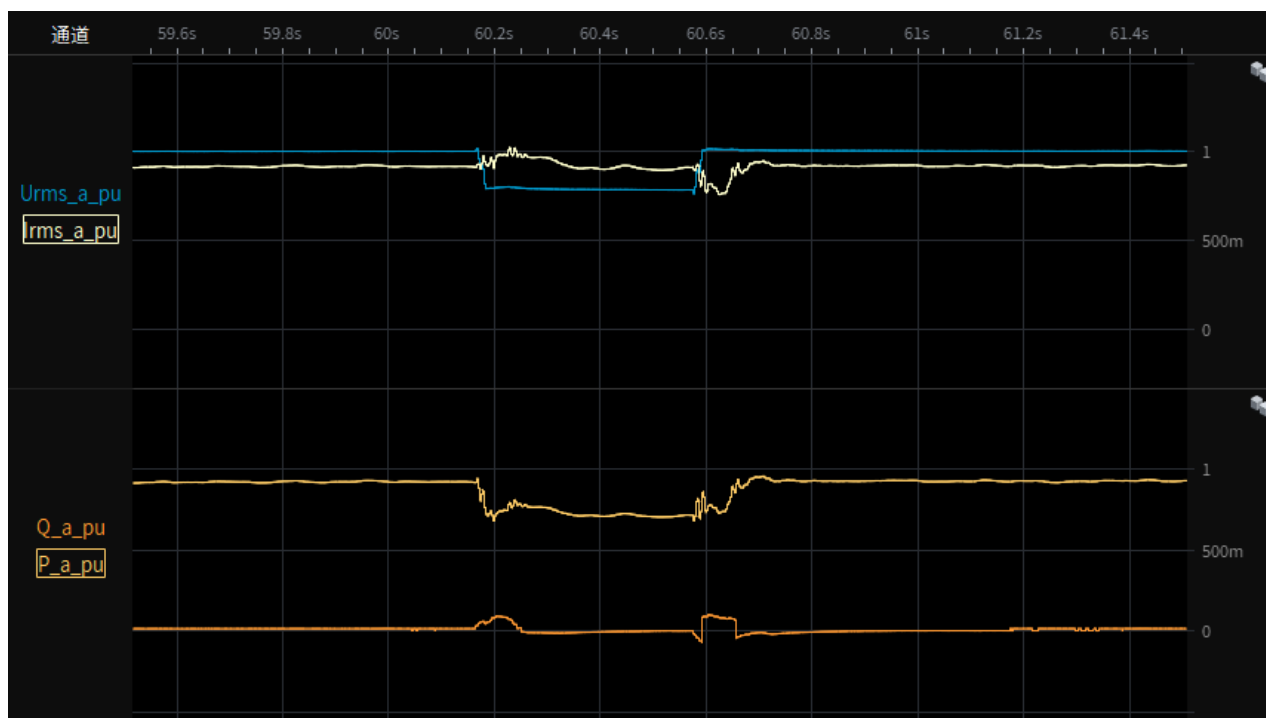

Test 2a-2.2 Depth of fault phase: 0.25p.u.,two-phase-asymmetrical (type D),95% load
Instantaneous curve and RMS value of phase-to-neutral voltages

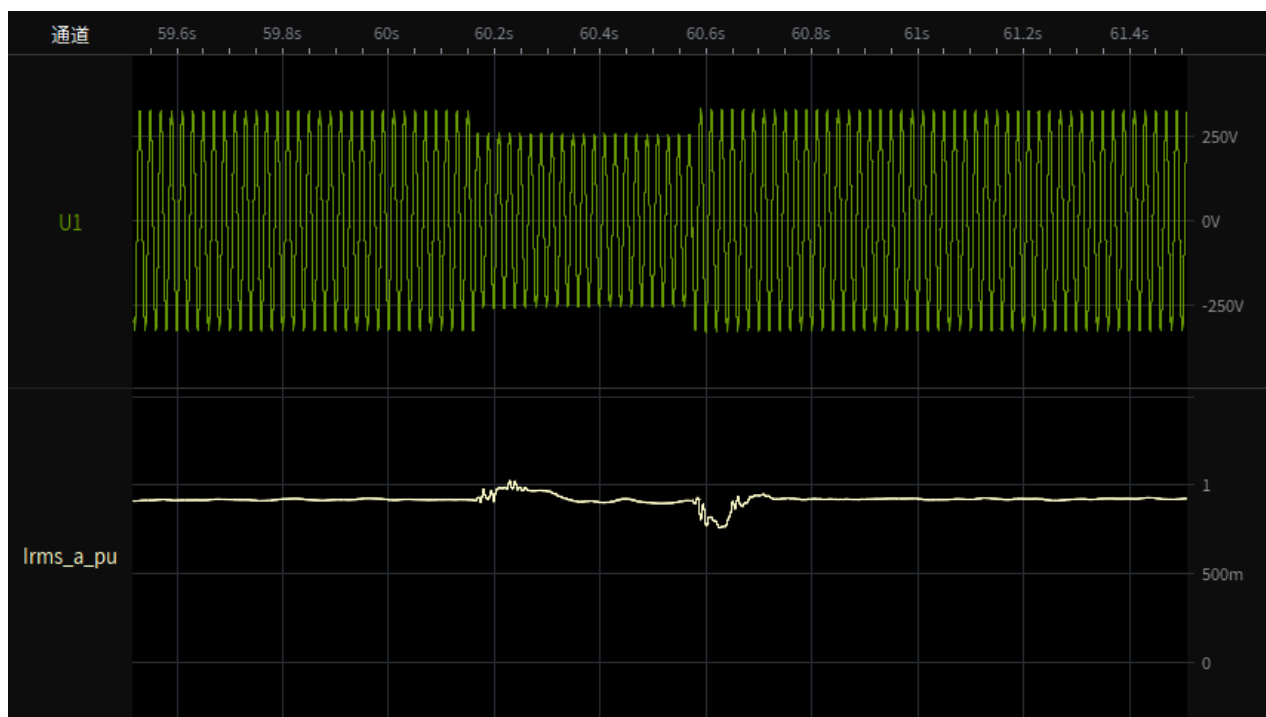

CEI 0-21			
Clause	Requirement - Test	Result - Remark	Verdict

Test 2a-2.3 Depth of fault phase: 0.25p.u., two-phase-asymmetrical (type D), 95% load
Instantaneous curve and RMS value of phase currents

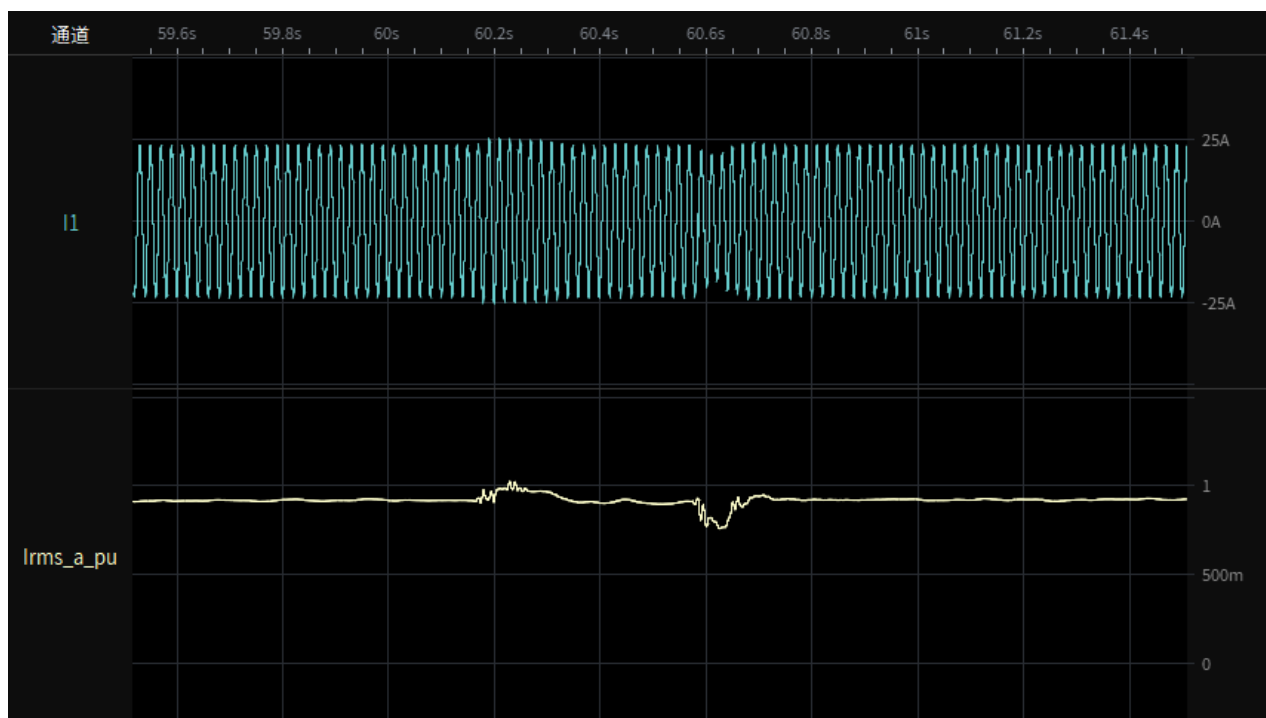

Test 2a-2.4 Depth of fault phase: 0.25p.u., two-phase-asymmetrical (type D), 95% load
restoring time

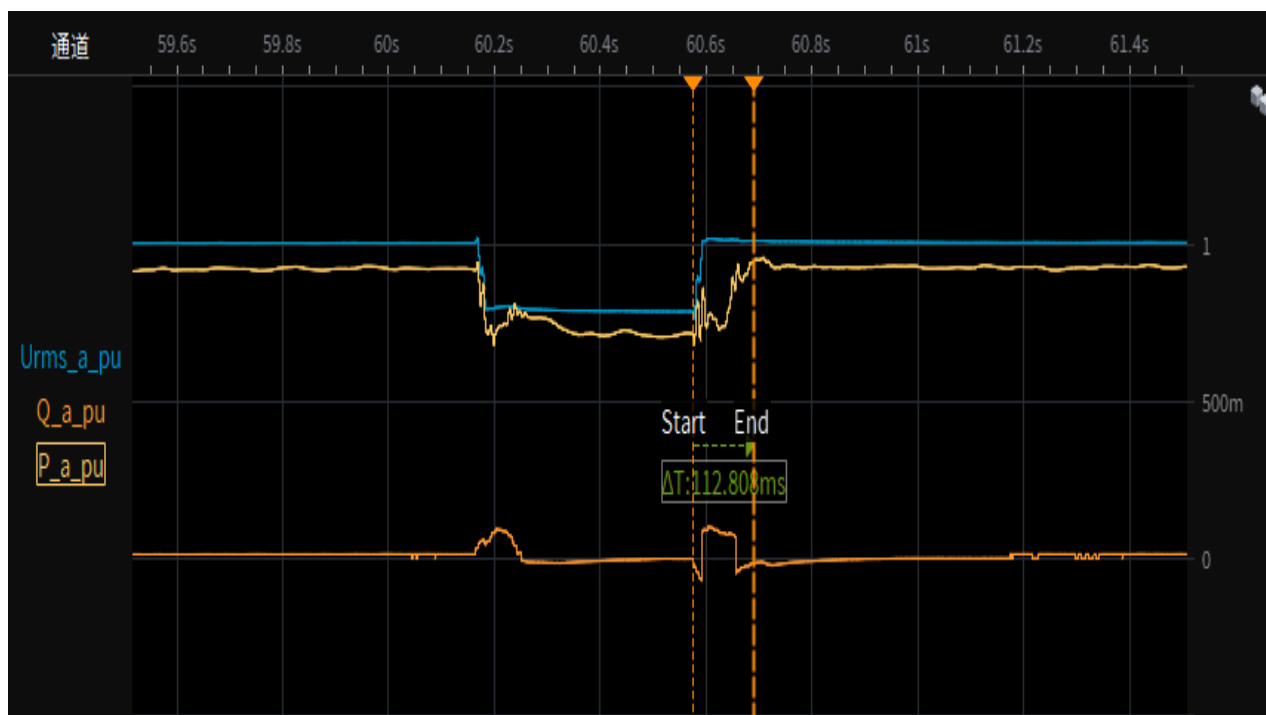

CEI 0-21			
Clause	Requirement - Test	Result - Remark	Verdict

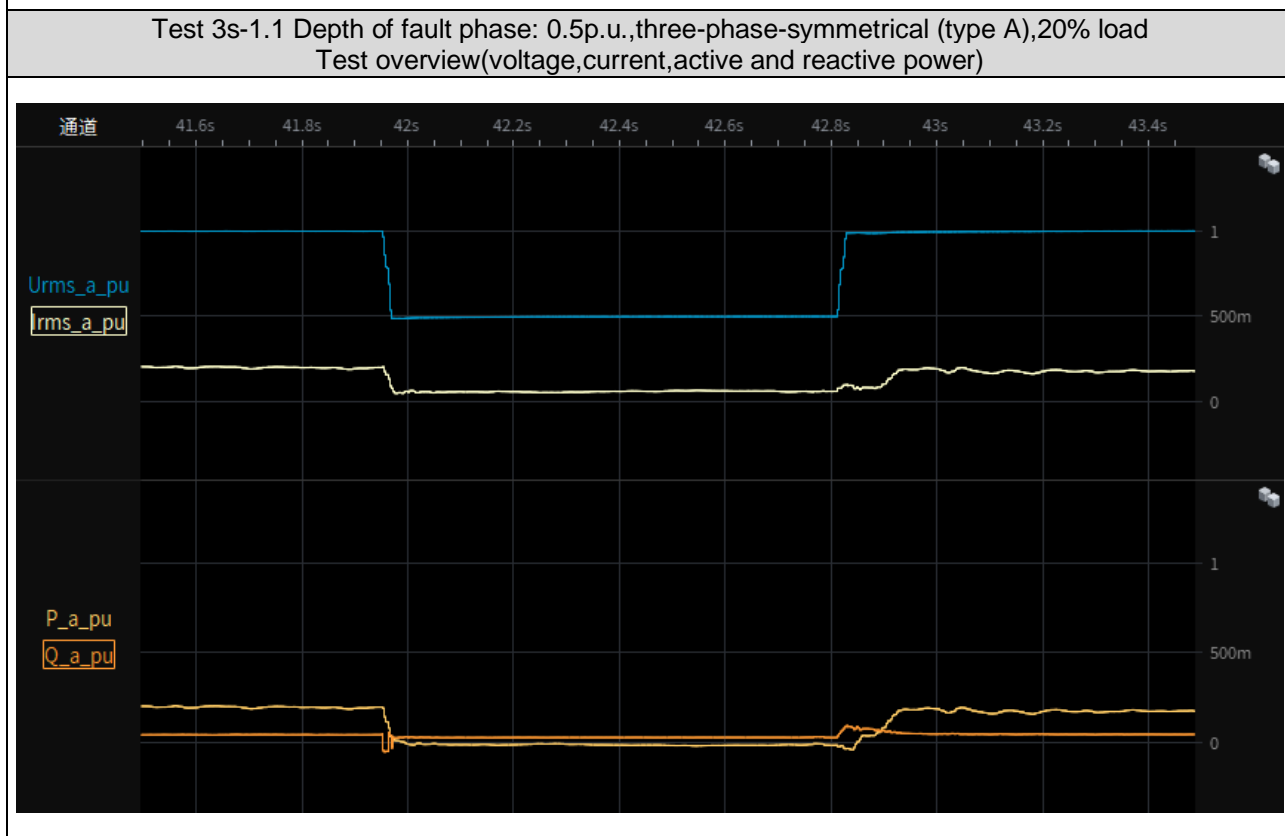
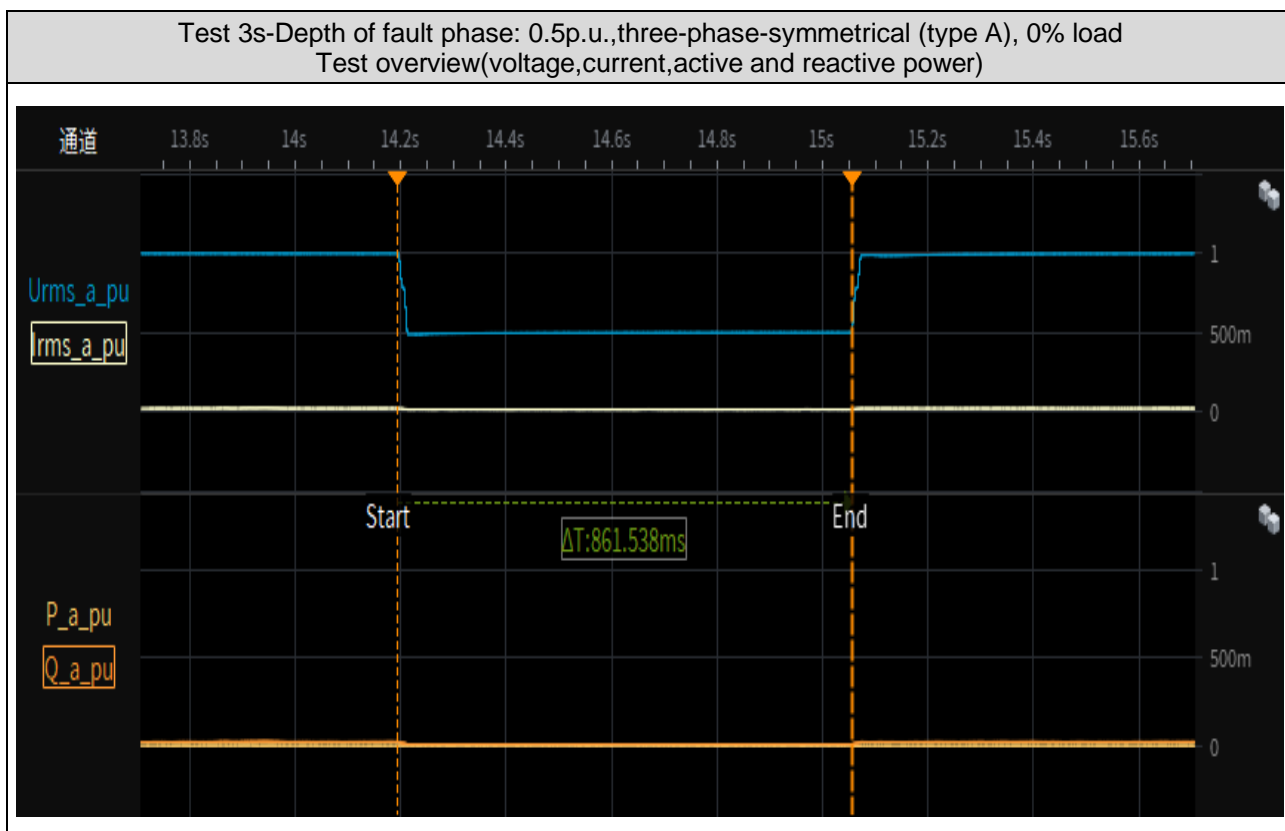

CEI 0-21			
Clause	Requirement - Test	Result - Remark	Verdict

Test 3s-1.2 Depth of fault phase: 0.5p.u.,three-phase-symmetrical (type A),20% load
Instantaneous curve and RMS value of phase-to-neutral voltages

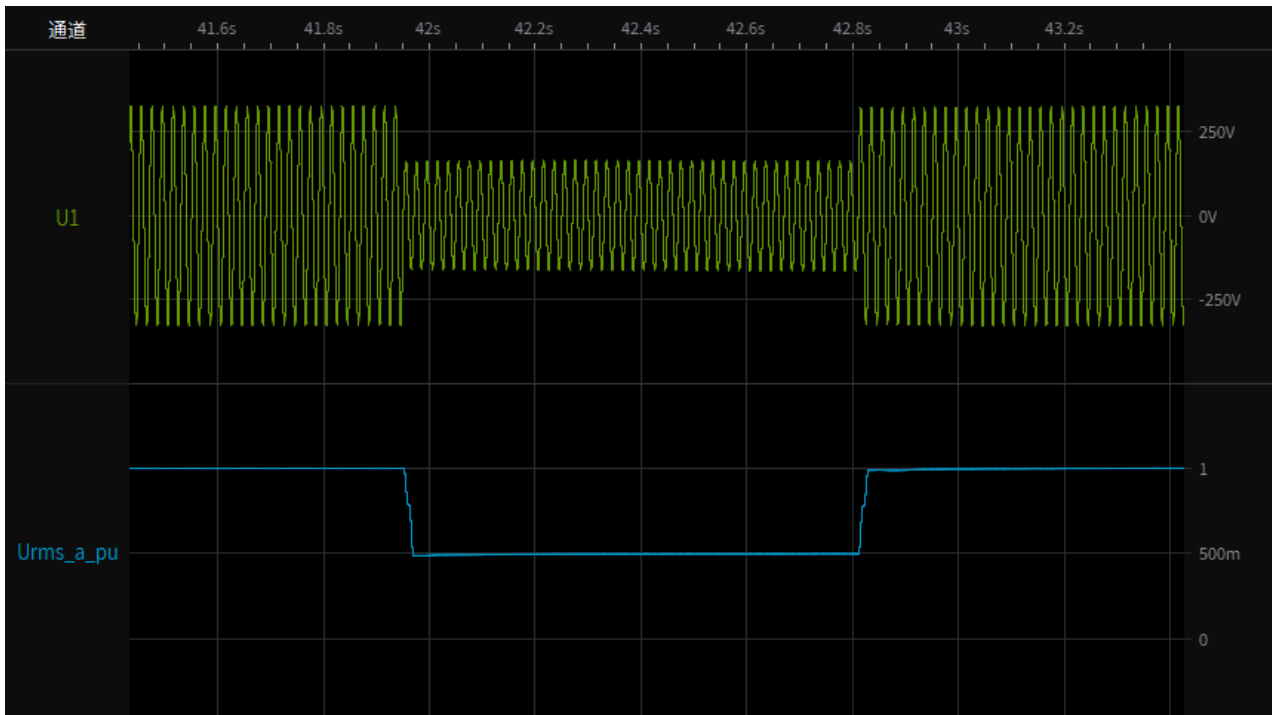

Test 3s-1.3 Depth of fault phase: 0.5p.u.,three-phase-symmetrical (type A),20% load
Instantaneous curve and RMS value of phase currents

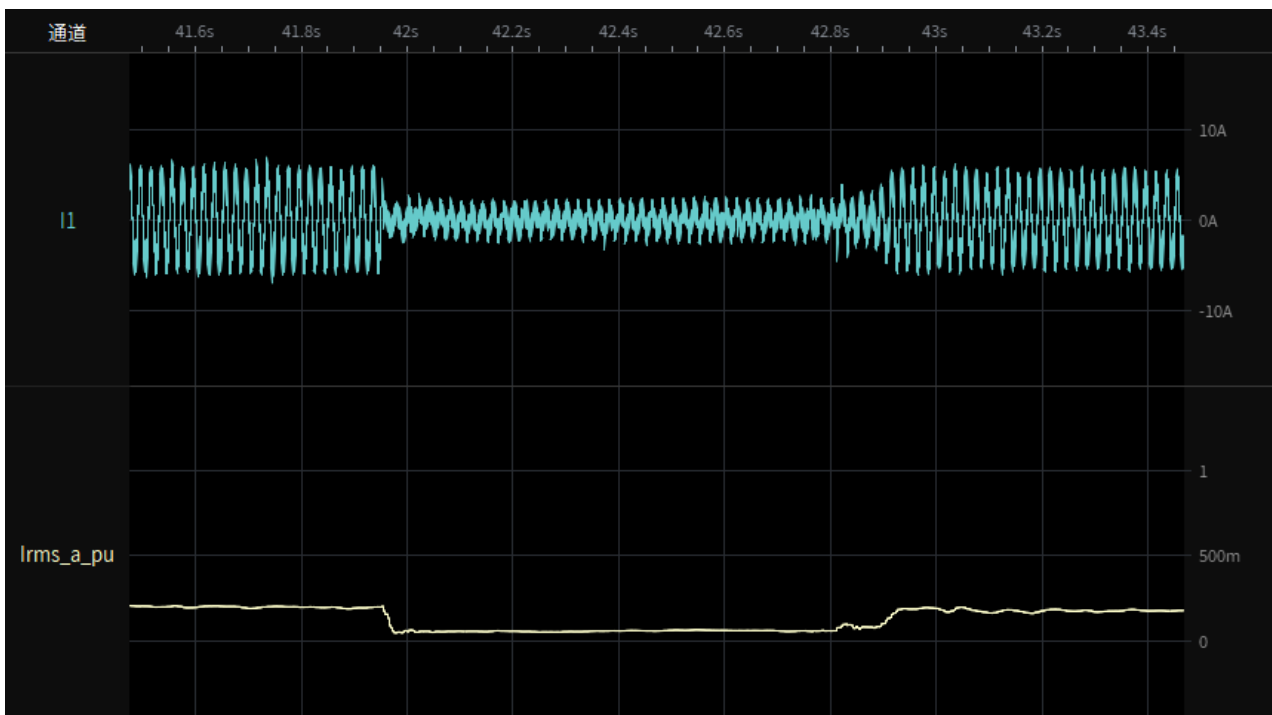

CEI 0-21			
Clause	Requirement - Test	Result - Remark	Verdict

Test 3s-1.4 Depth of fault phase: 0.5p.u.,three-phase-symmetrical (type A),20% load restoring time

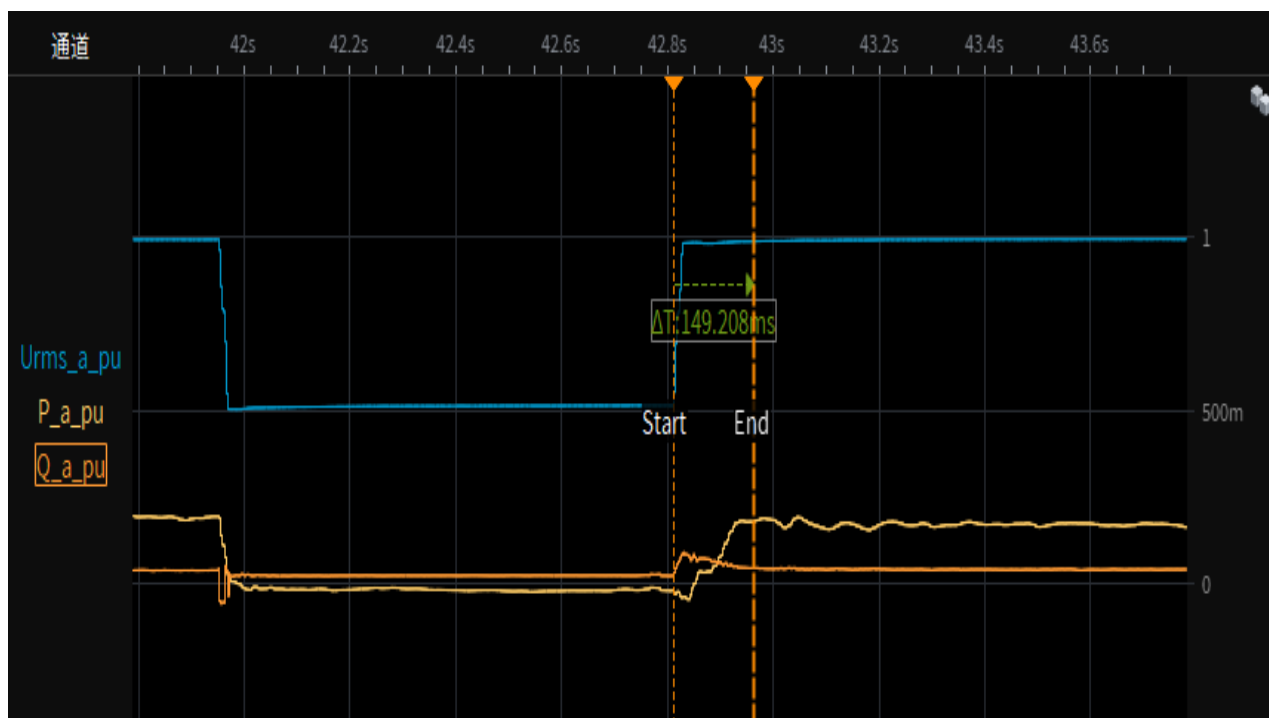

Test 3s-2.1 Depth of fault phase: 0.5p.u.,three-phase-symmetrical (type A),95% load Test overview(voltage,current,active and reactive power)

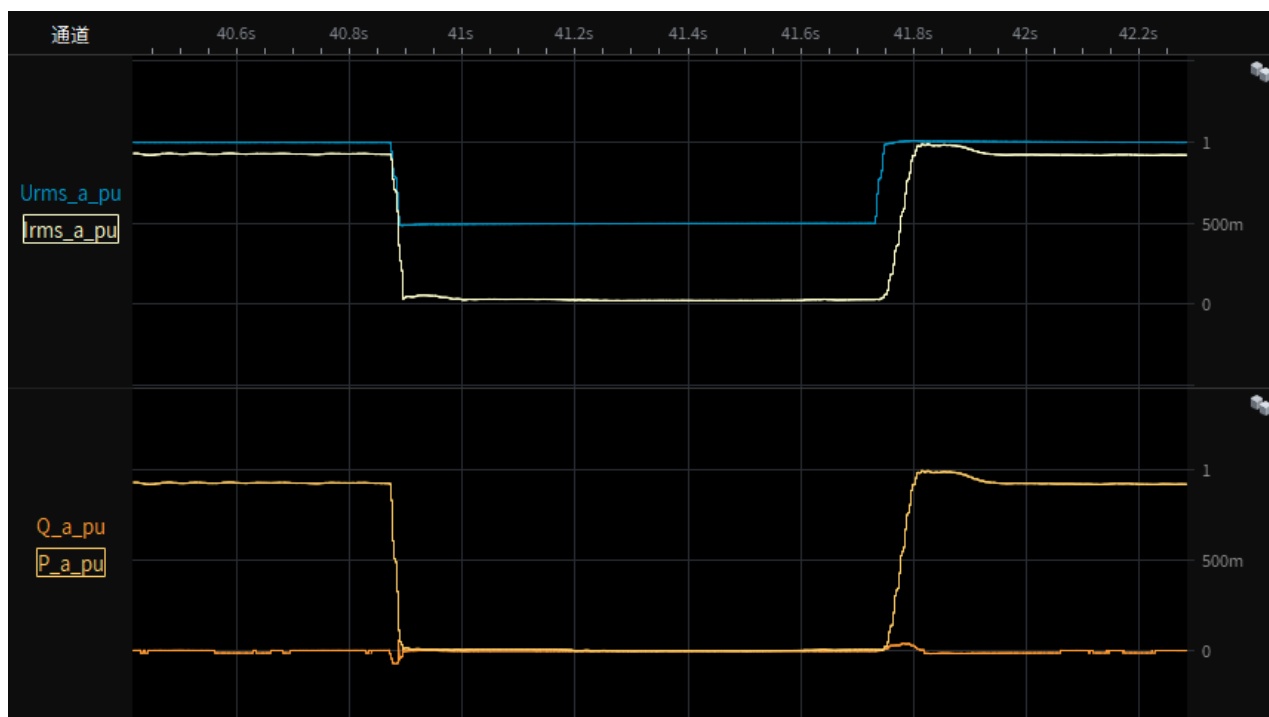

CEI 0-21			
Clause	Requirement - Test	Result - Remark	Verdict

Test 3s-2.2 Depth of fault phase: 0.5p.u.,three-phase-symmetrical (type A),95% load
Instantaneous curve and RMS value of phase-to-neutral voltages

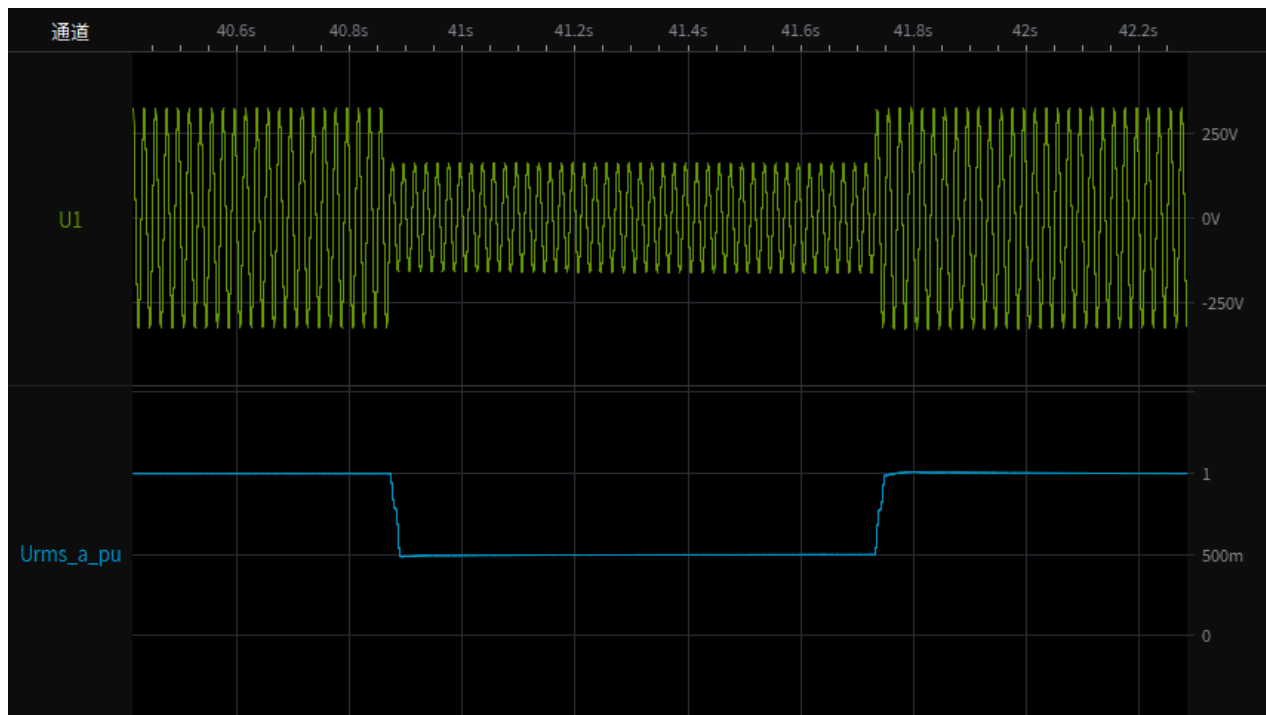

Test 3s-2.3 Depth of fault phase: 0.5p.u.,three-phase-symmetrical (type A),95% load
Instantaneous curve and RMS value of phase currents

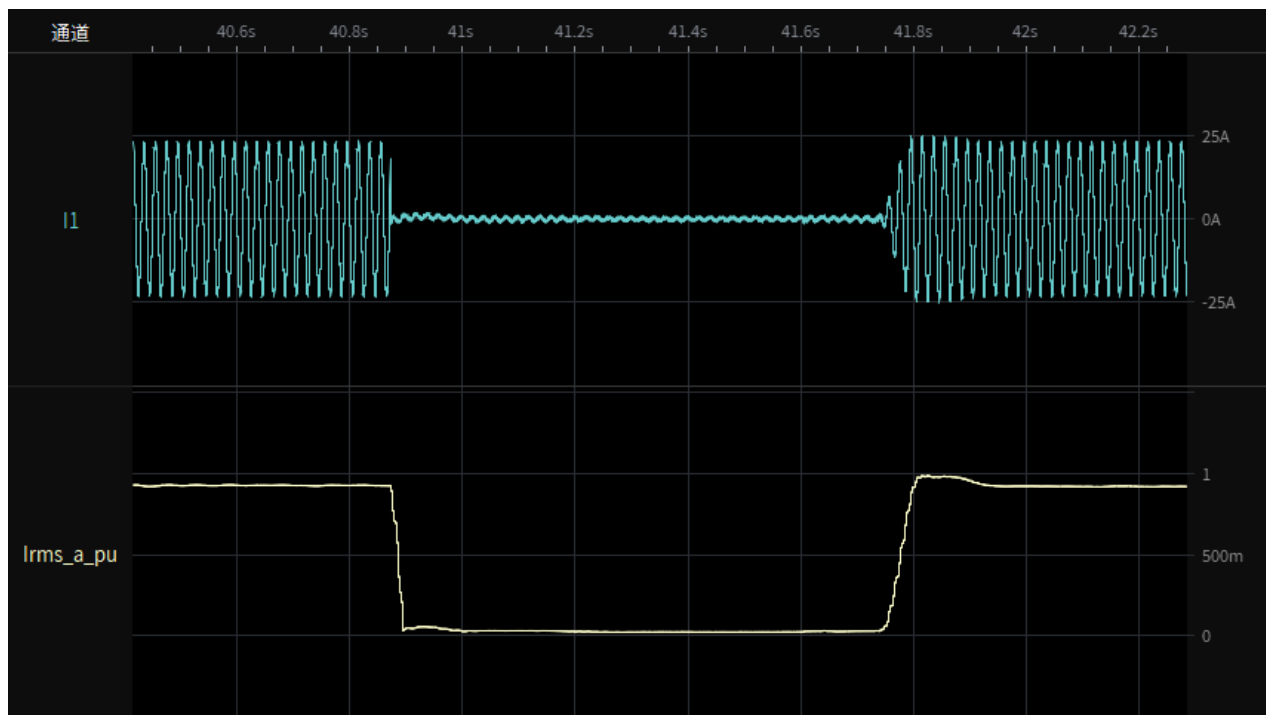

CEI 0-21			
Clause	Requirement - Test	Result - Remark	Verdict

Test 3s-2.4 Depth of fault phase: 0.5p.u.,three-phase-symmetrical (type A), 95% load restoring time

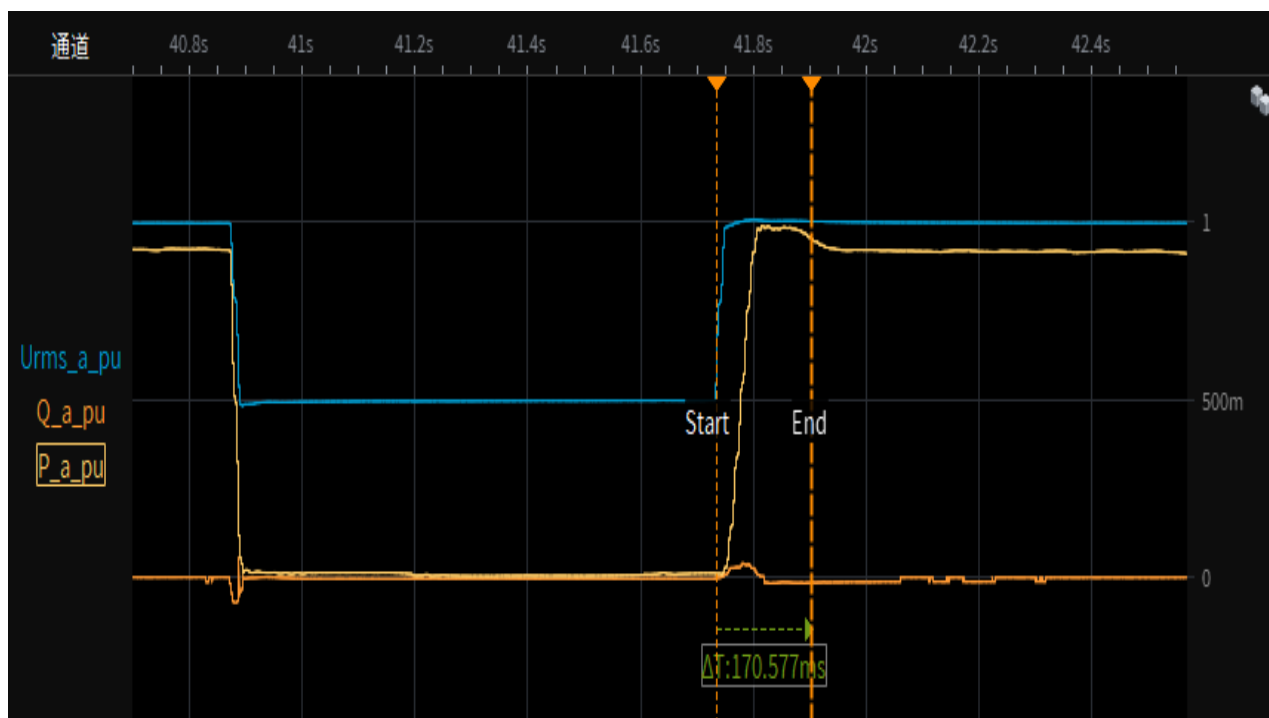

Test 3a-Depth of fault phase: 0.5p.u.,two-phase-asymmetrical (type D), 0% load Test overview(voltage,current,active and reactive power)

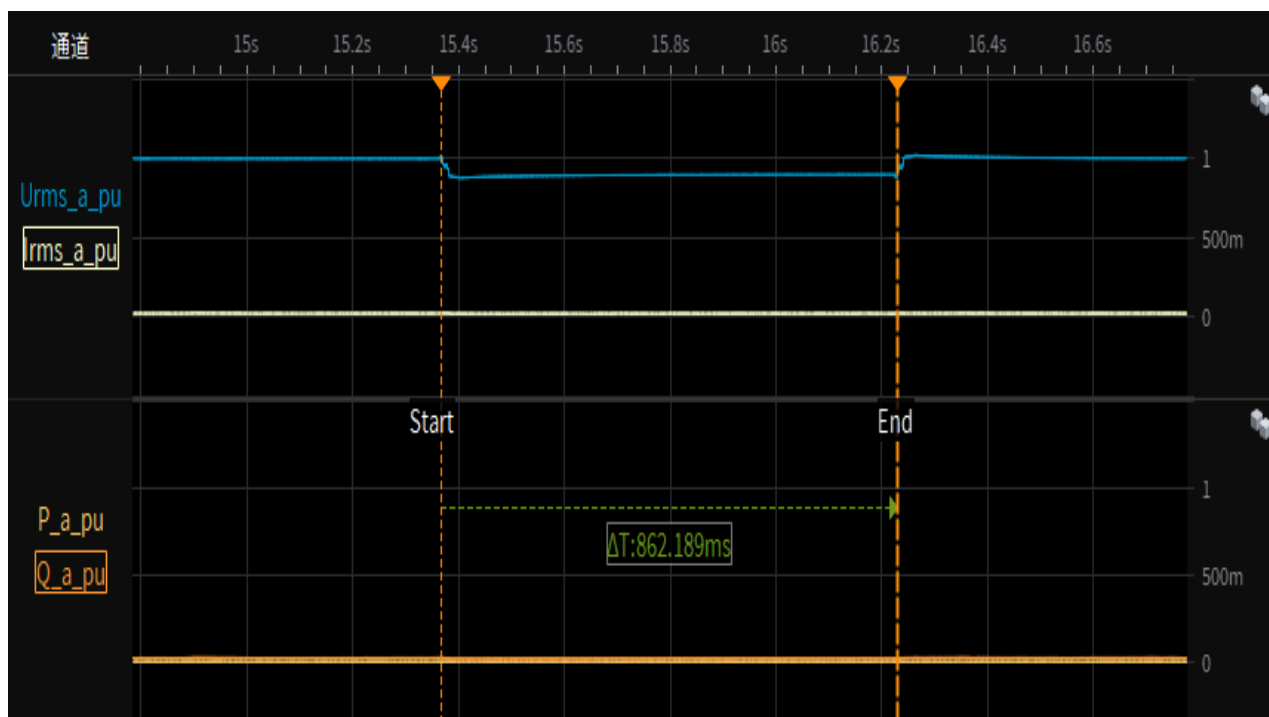

CEI 0-21			
Clause	Requirement - Test	Result - Remark	Verdict

Test 3a-1.1 Depth of fault phase: 0.5p.u.,two-phase-asymmetrical (type D),20% load
Test overview(voltage,current,active and reactive power)

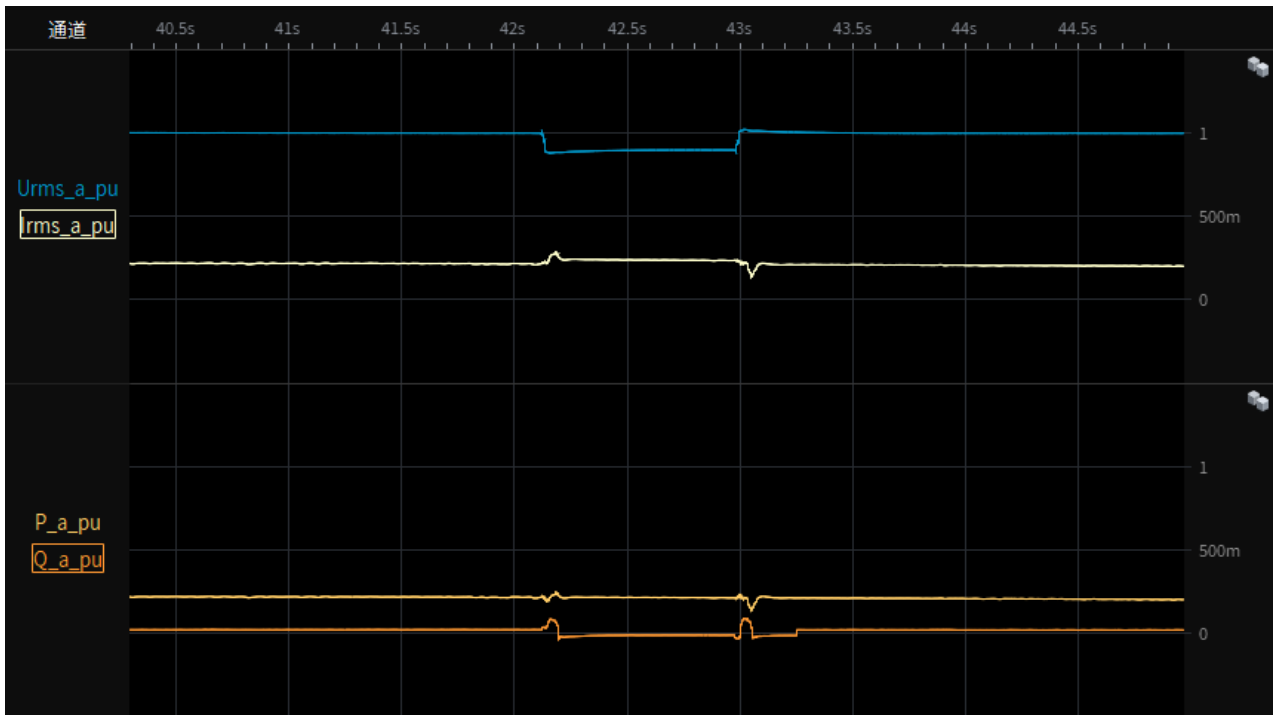

Test 3a-1.2 Depth of fault phase: 0.5p.u.,two-phase-asymmetrical (type D),20% load
Instantaneous curve and RMS value of phase-to-neutral voltages

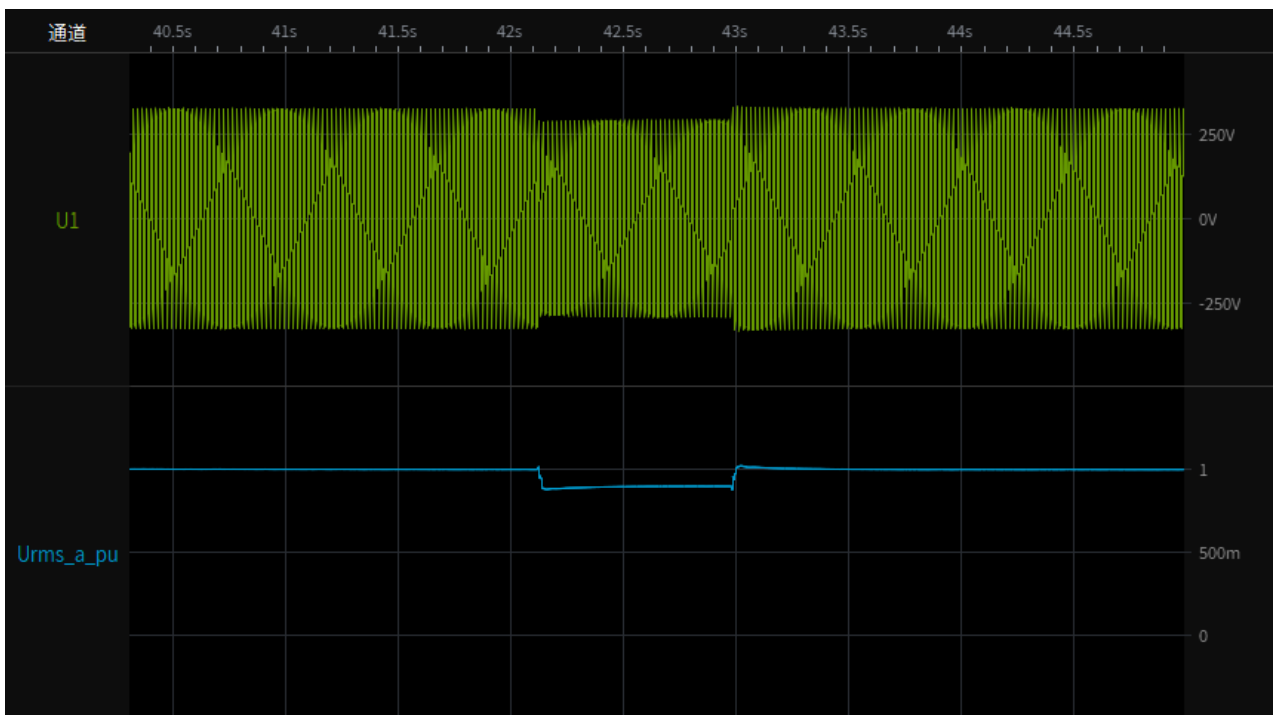

CEI 0-21			
Clause	Requirement - Test	Result - Remark	Verdict

Test 3a-1.3 Depth of fault phase: 0.5p.u.,two-phase-asymmetrical (type D),20% load
Instantaneous curve and RMS value of phase currents

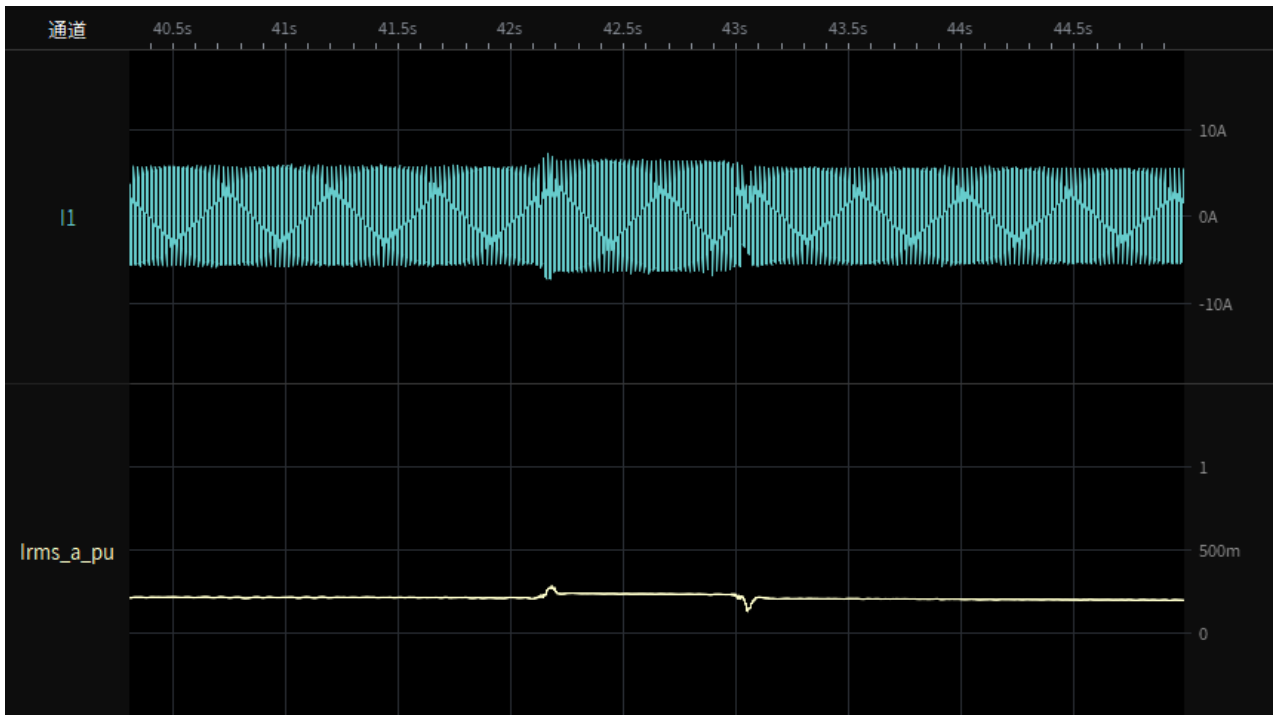

Test 3a-1.4 Depth of fault phase: 0.5p.u.,two-phase-asymmetrical (type D),20% load
restoring time

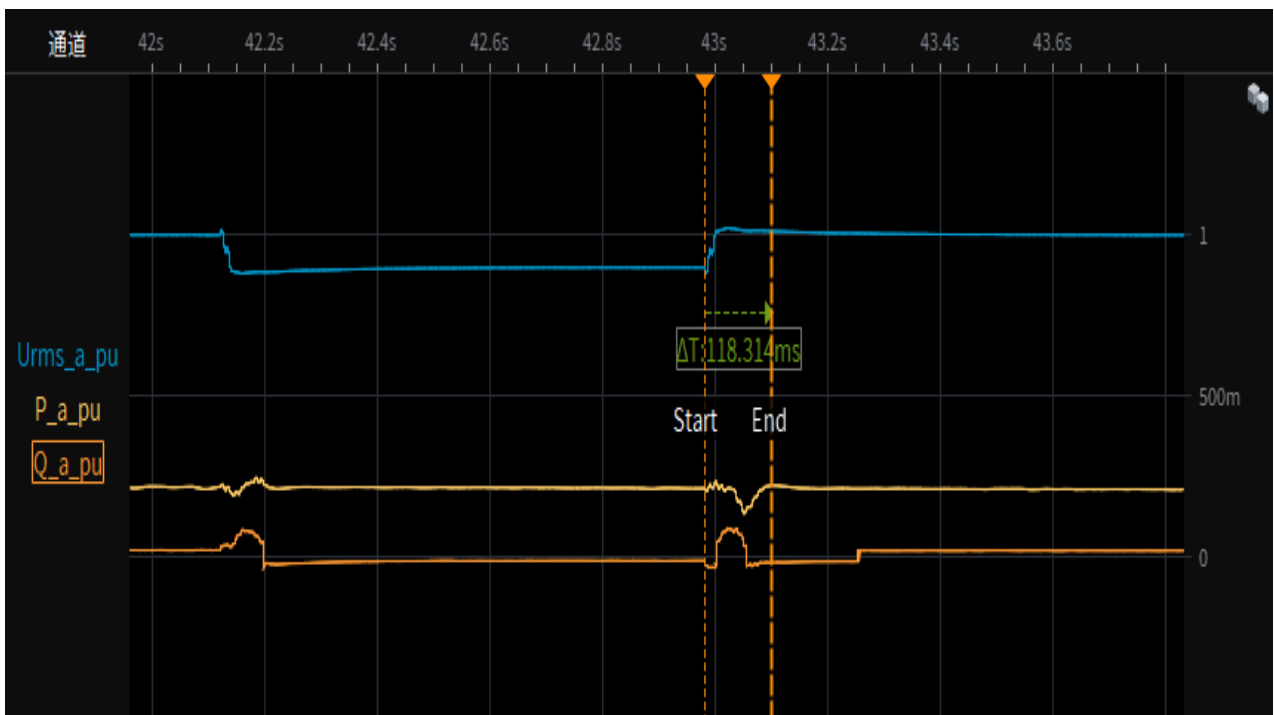

CEI 0-21			
Clause	Requirement - Test	Result - Remark	Verdict

Test 3a-2.1 Depth of fault phase: 0.5p.u.,two-phase-asymmetrical (type D),95% load
Test overview(voltage,current,active and reactive power)

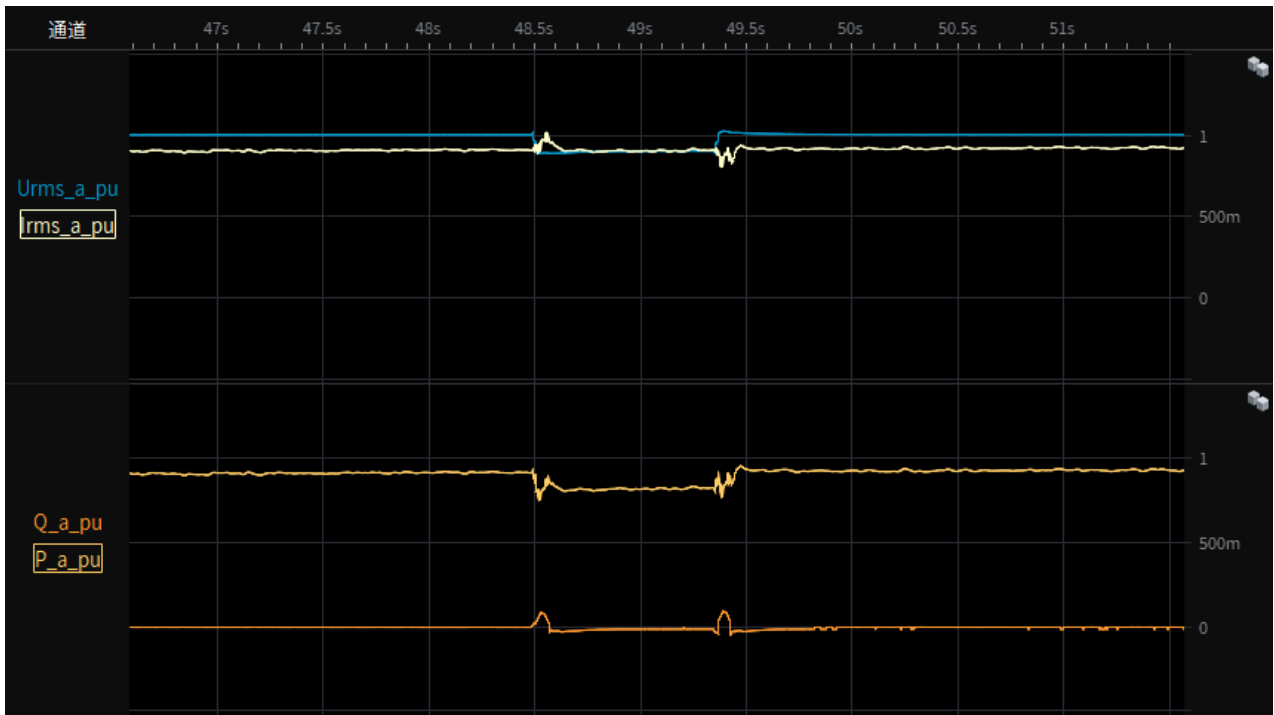

Test 3a-2.2 Depth of fault phase: 0.5p.u.,two-phase-asymmetrical (type D),95% load
Instantaneous curve and RMS value of phase-to-neutral voltages

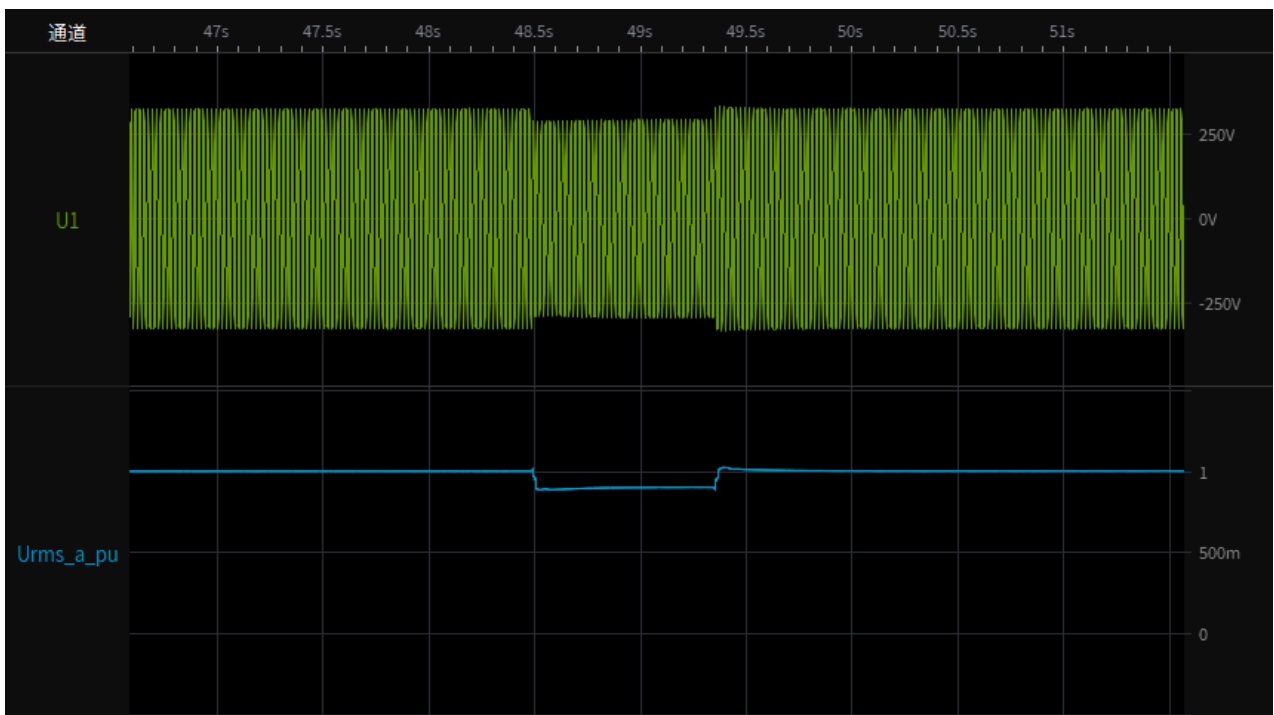

CEI 0-21			
Clause	Requirement - Test	Result - Remark	Verdict

Test 3a-2.3 Depth of fault phase: 0.5p.u.,two-phase-asymmetrical (type D),95% load
Instantaneous curve and RMS value of phase currents

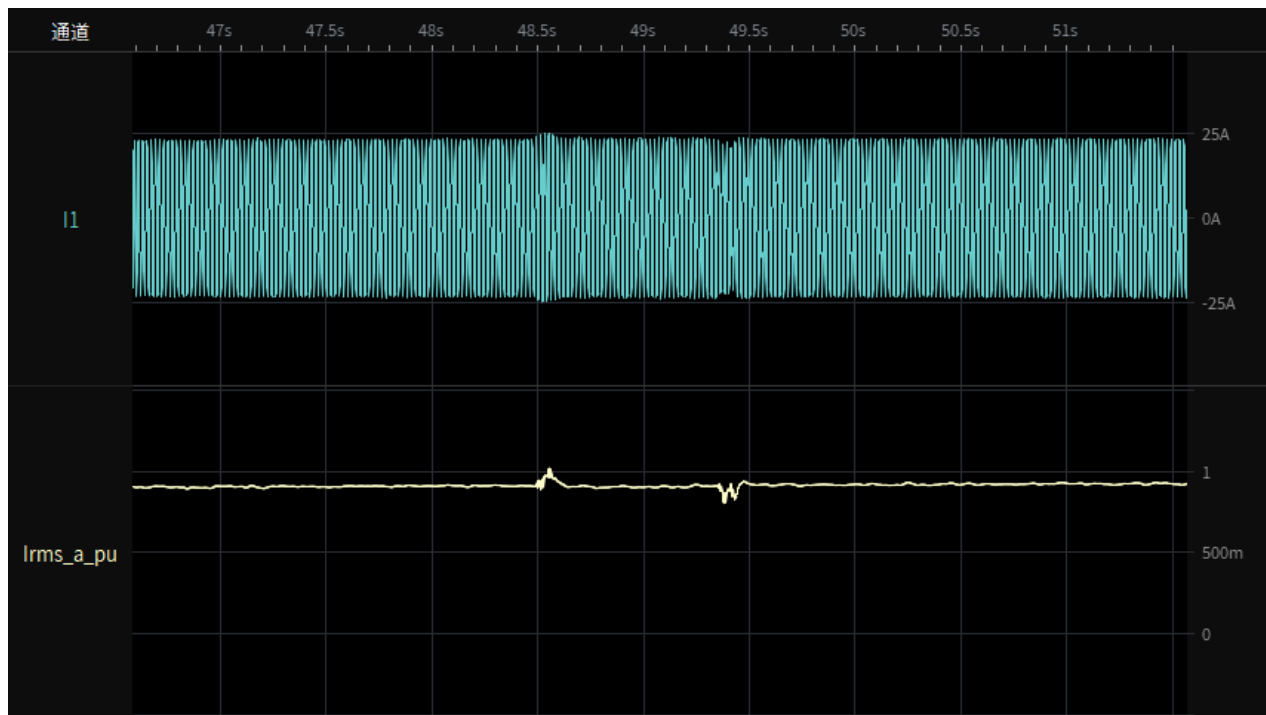

Test 3a-2.4 Depth of fault phase: 0.5p.u.,two-phase-asymmetrical (type D), 95% load
restoring time



CEI 0-21			
Clause	Requirement - Test	Result - Remark	Verdict

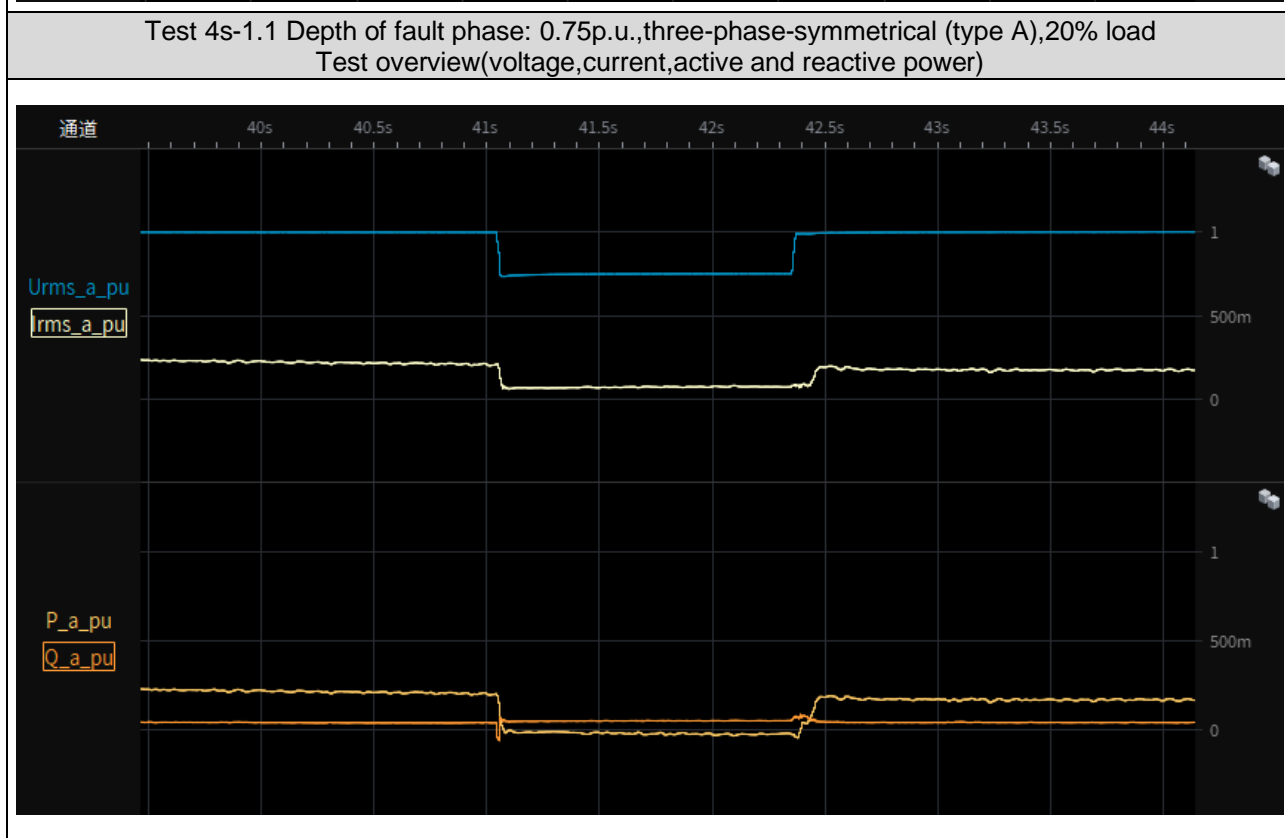
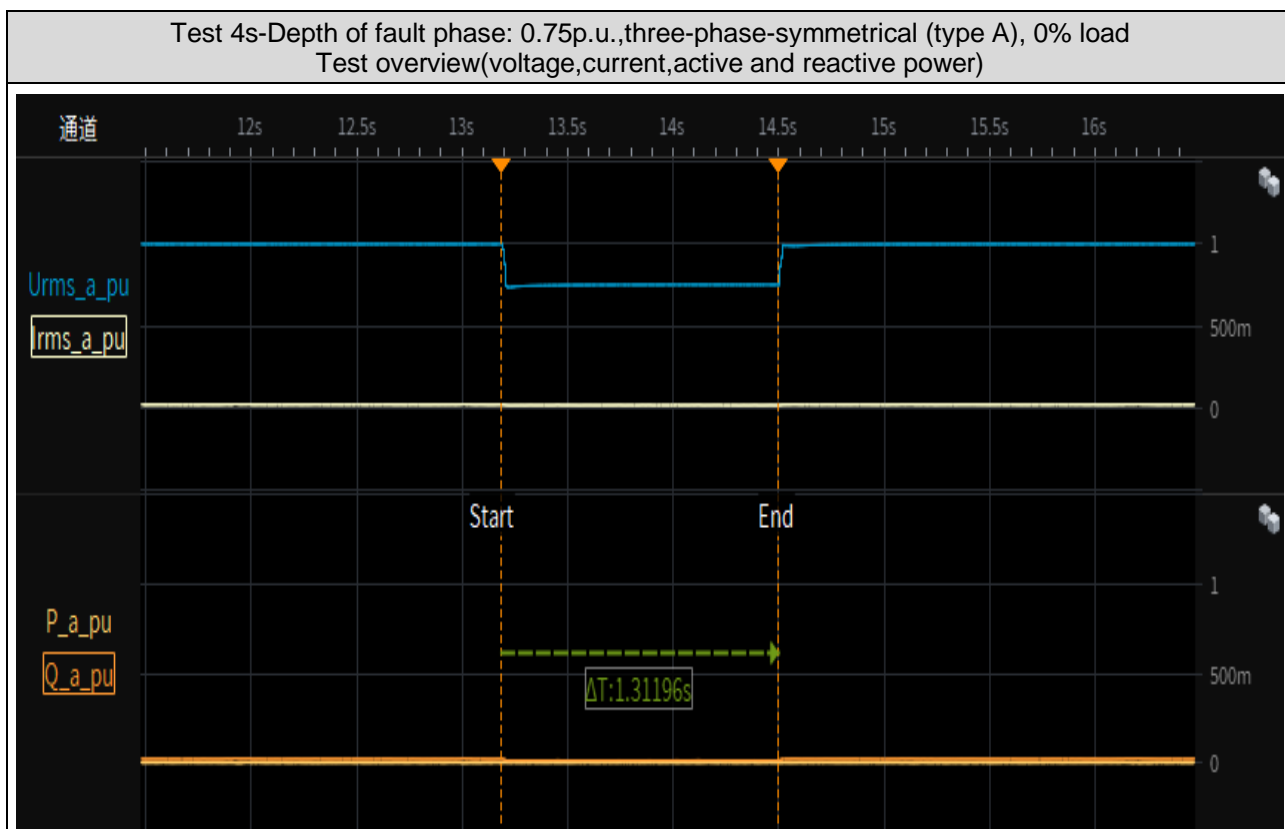

CEI 0-21			
Clause	Requirement - Test	Result - Remark	Verdict

Test 4s-1.2 Depth of fault phase: 0.75p.u.,three-phase-symmetrical (type A),20% load
Instantaneous curve and RMS value of phase-to-neutral voltages

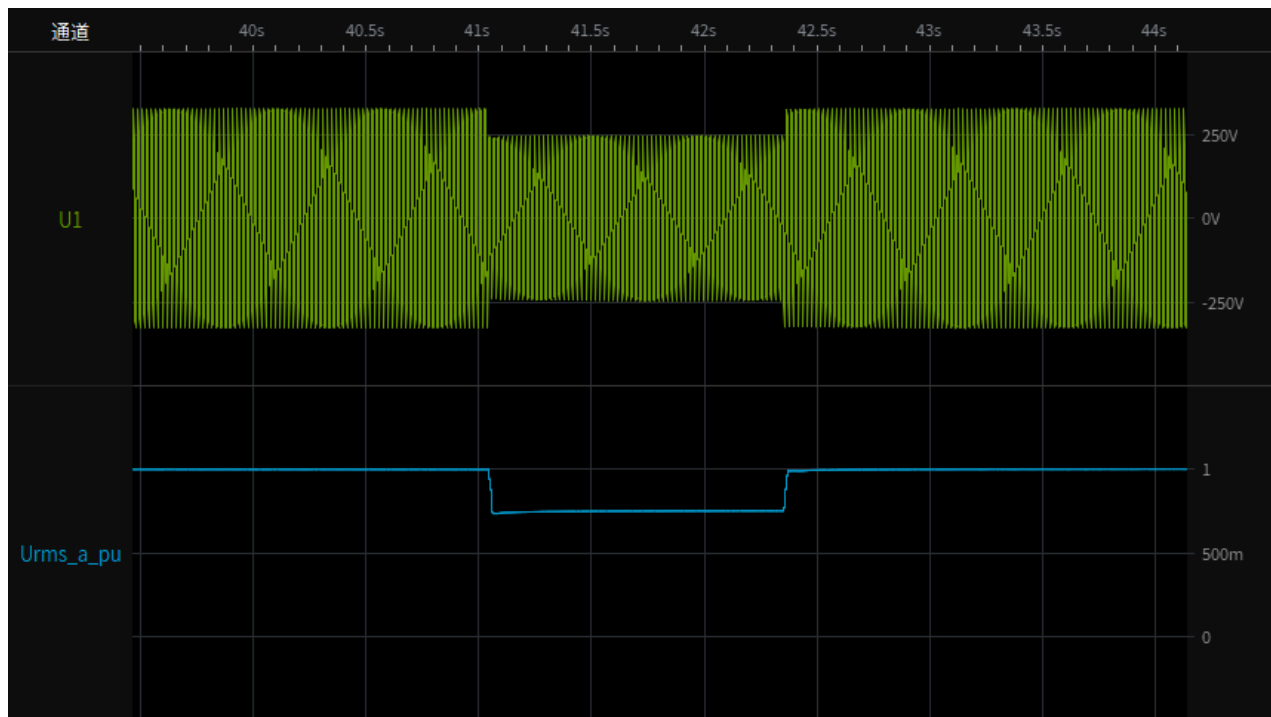

Test 4s-1.3 Depth of fault phase: 0.75p.u.,three-phase-symmetrical (type A),20% load
Instantaneous curve and RMS value of phase currents

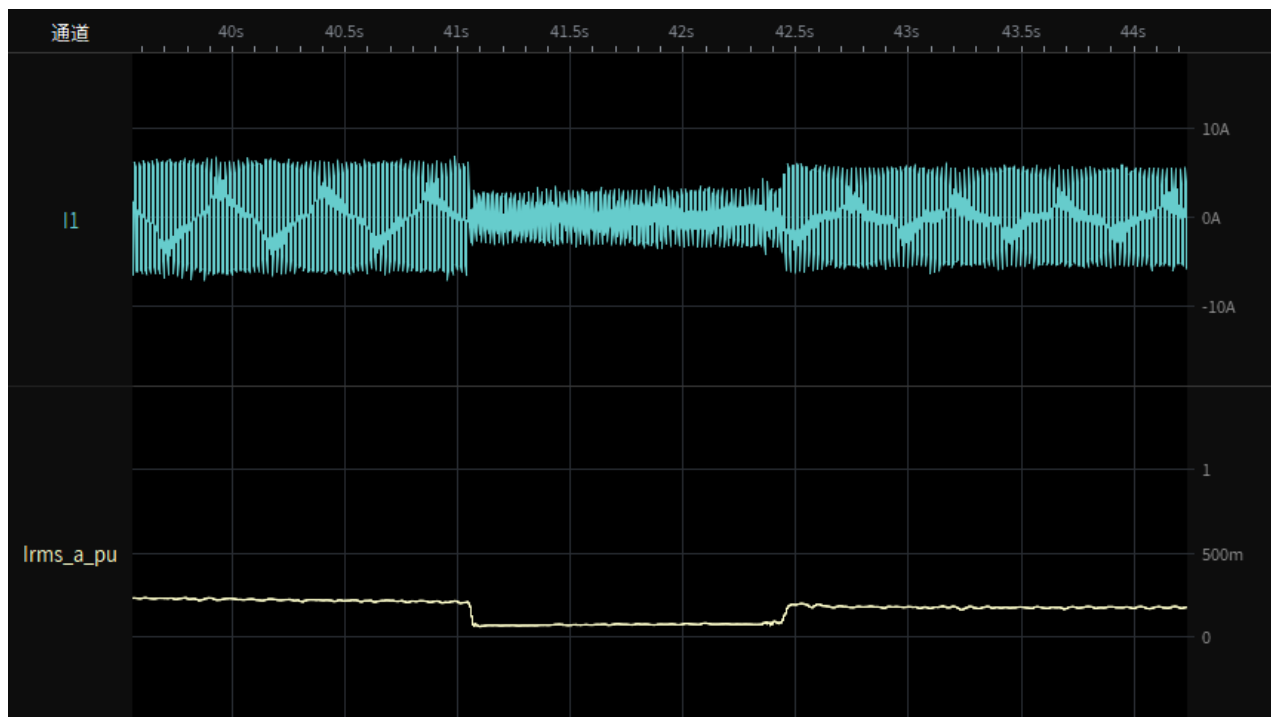

CEI 0-21			
Clause	Requirement - Test	Result - Remark	Verdict

Test 4s-1.4 Depth of fault phase: 0.75p.u.,three-phase-symmetrical (type A),20% load restoring time

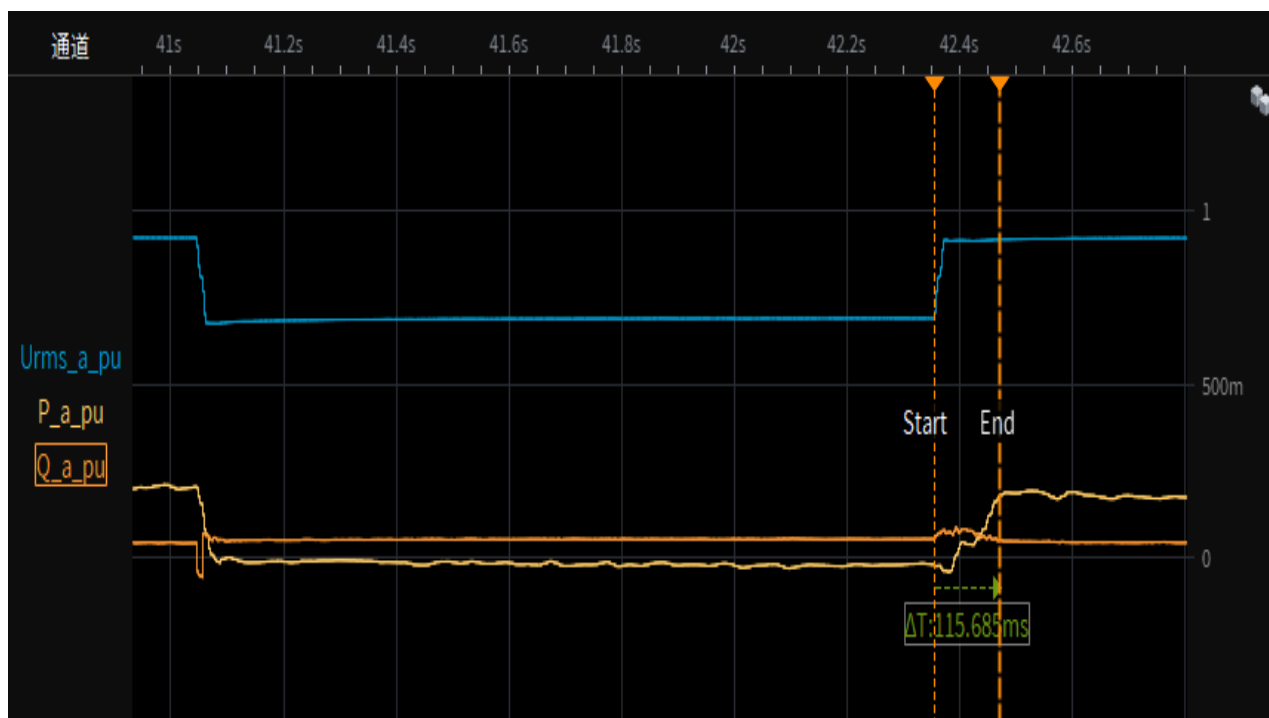

Test 4s-2.1 Depth of fault phase: 0.75p.u.,three-phase-symmetrical (type A),95% load Test overview(voltage,current,active and reactive power)

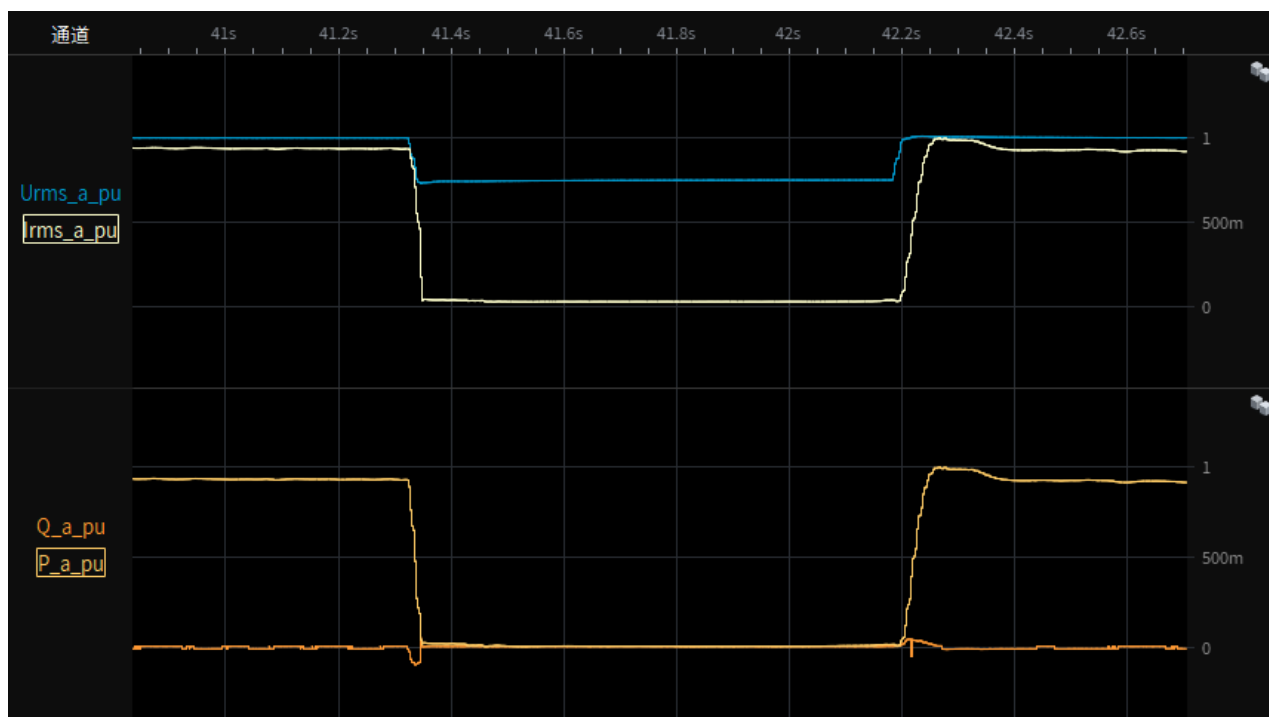

CEI 0-21			
Clause	Requirement - Test	Result - Remark	Verdict

Test 4s-2.2 Depth of fault phase: 0.75p.u.,three-phase-symmetrical (type A),95% load
Instantaneous curve and RMS value of phase-to-neutral voltages

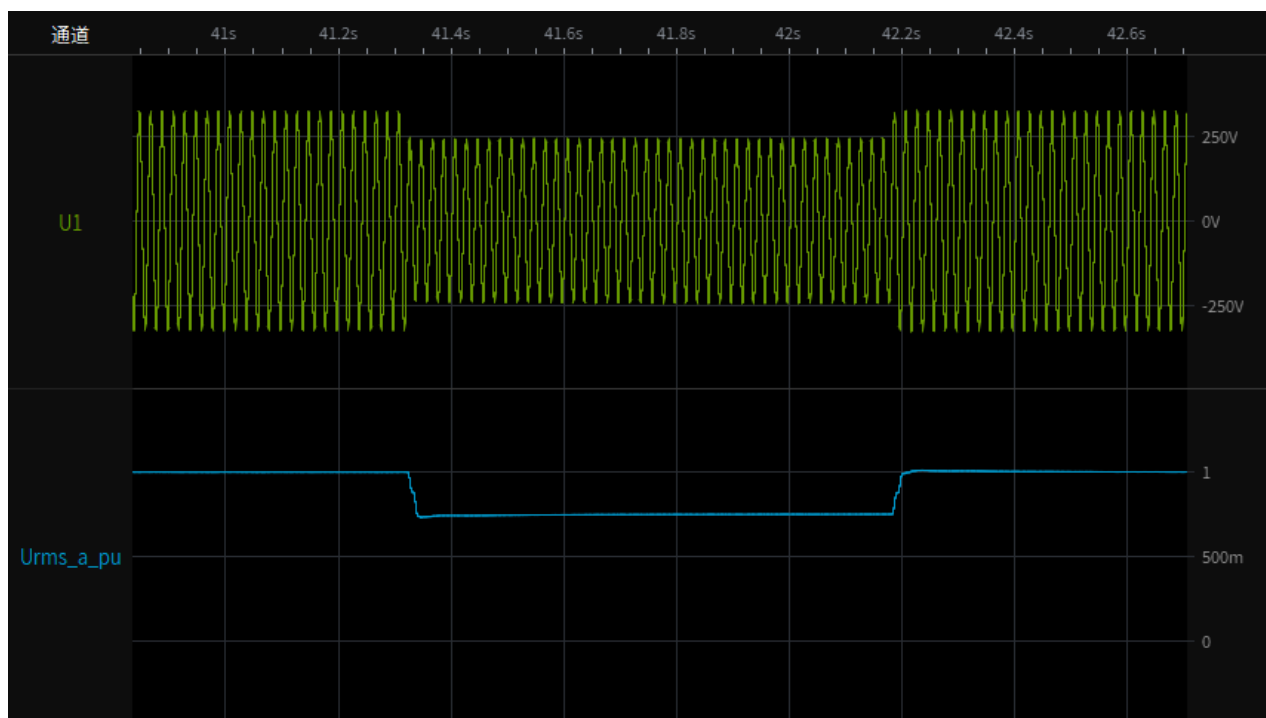

Test 4s-2.3 Depth of fault phase: 0.75p.u.,three-phase-symmetrical (type A),95% load
Instantaneous curve and RMS value of phase currents

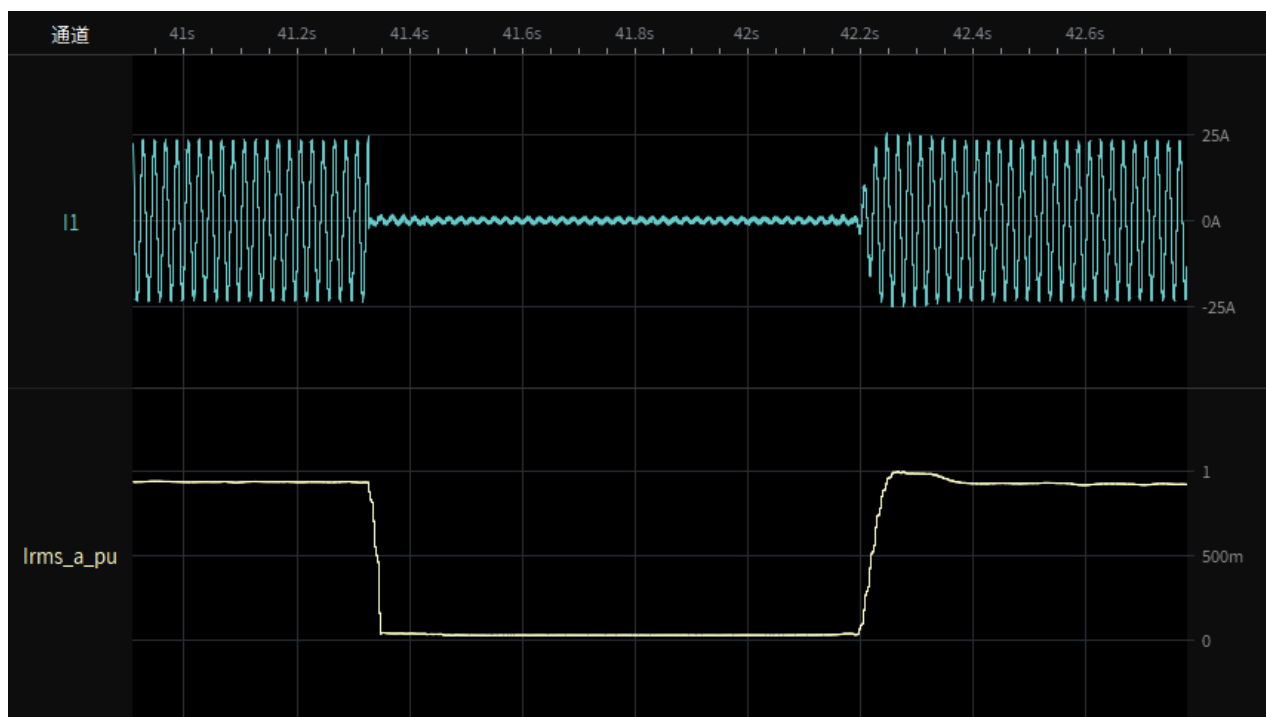

CEI 0-21			
Clause	Requirement - Test	Result - Remark	Verdict

Test 4s-2.4 Depth of fault phase: 0.75p.u.,three-phase-symmetrical (type A), 95% load restoring time



Test 4a-Depth of fault phase: 0.75p.u.,two-phase-asymmetrical (type D), 0% load Test overview(voltage,current,active and reactive power)

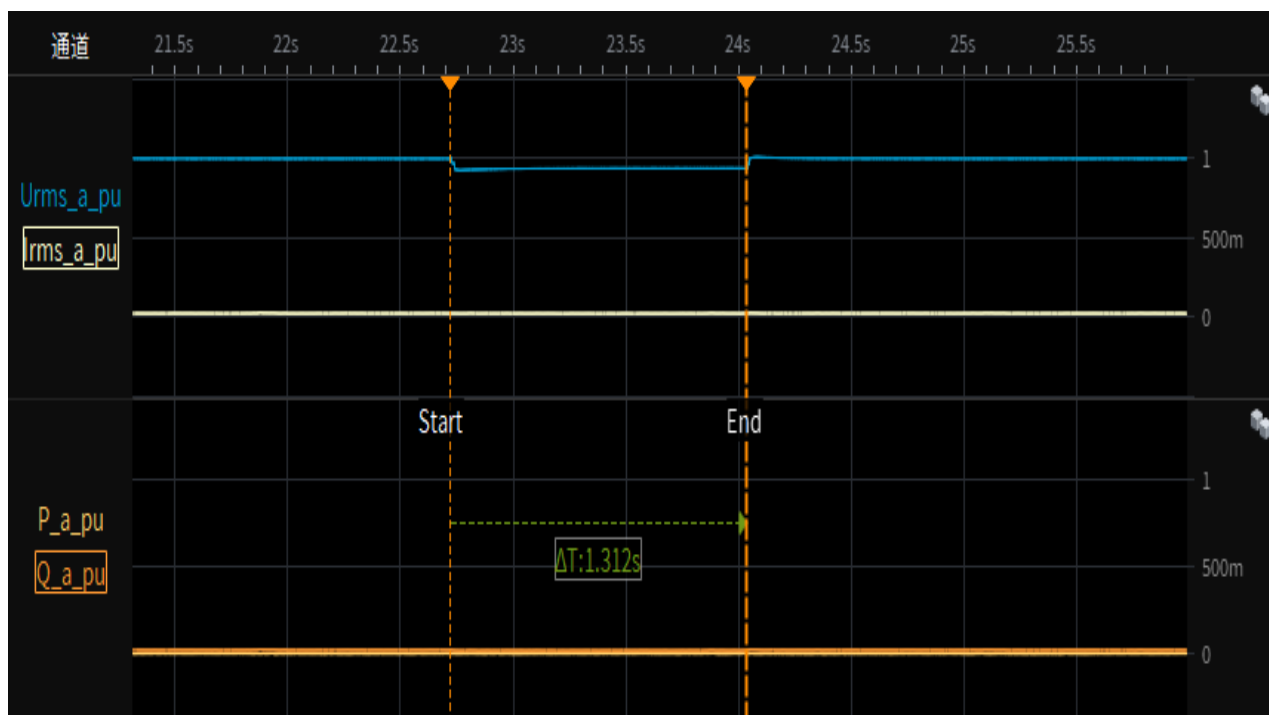

CEI 0-21			
Clause	Requirement - Test	Result - Remark	Verdict

Test 4a-1.1 Depth of fault phase: 0.75p.u.,two-phase-asymmetrical (type D),20% load
Test overview(voltage,current,active and reactive power)

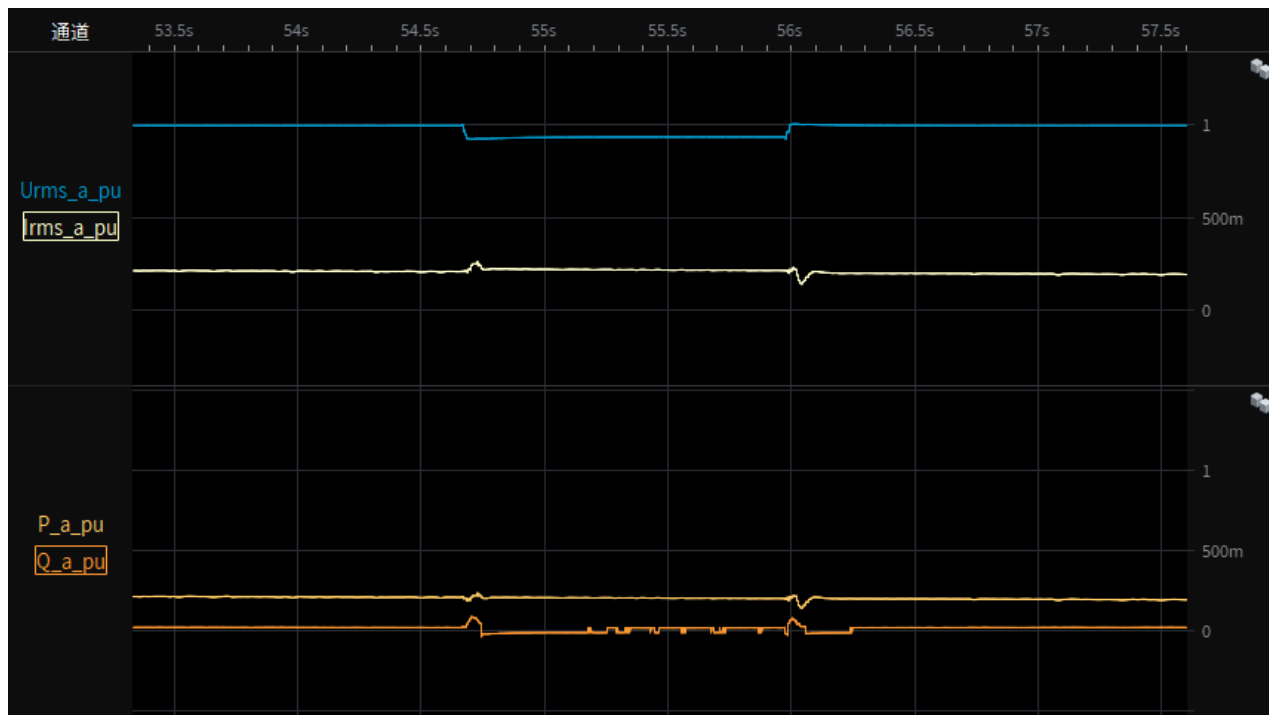

Test 4a-1.2 Depth of fault phase: 0.75p.u.,two-phase-asymmetrical (type D),20% load
Instantaneous curve and RMS value of phase-to-neutral voltages

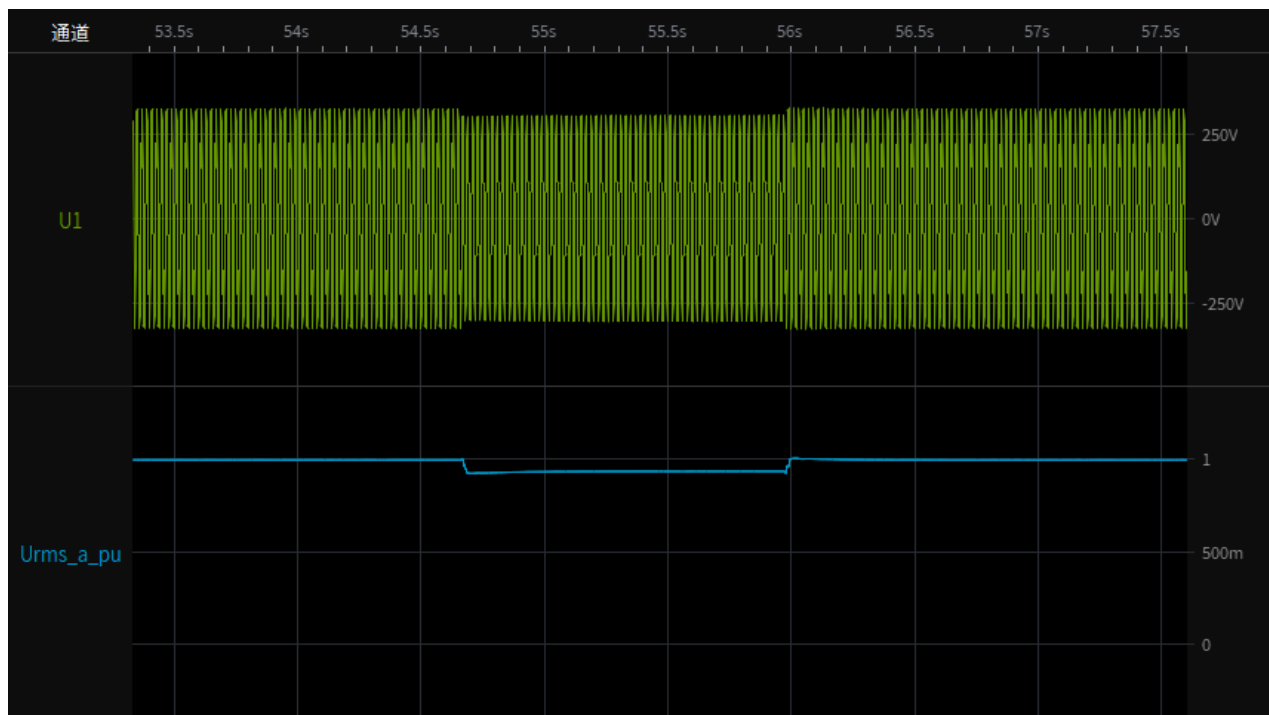

CEI 0-21			
Clause	Requirement - Test	Result - Remark	Verdict

Test 4a-1.3 Depth of fault phase: 0.75p.u.,two-phase-asymmetrical (type D),20% load
Instantaneous curve and RMS value of phase currents

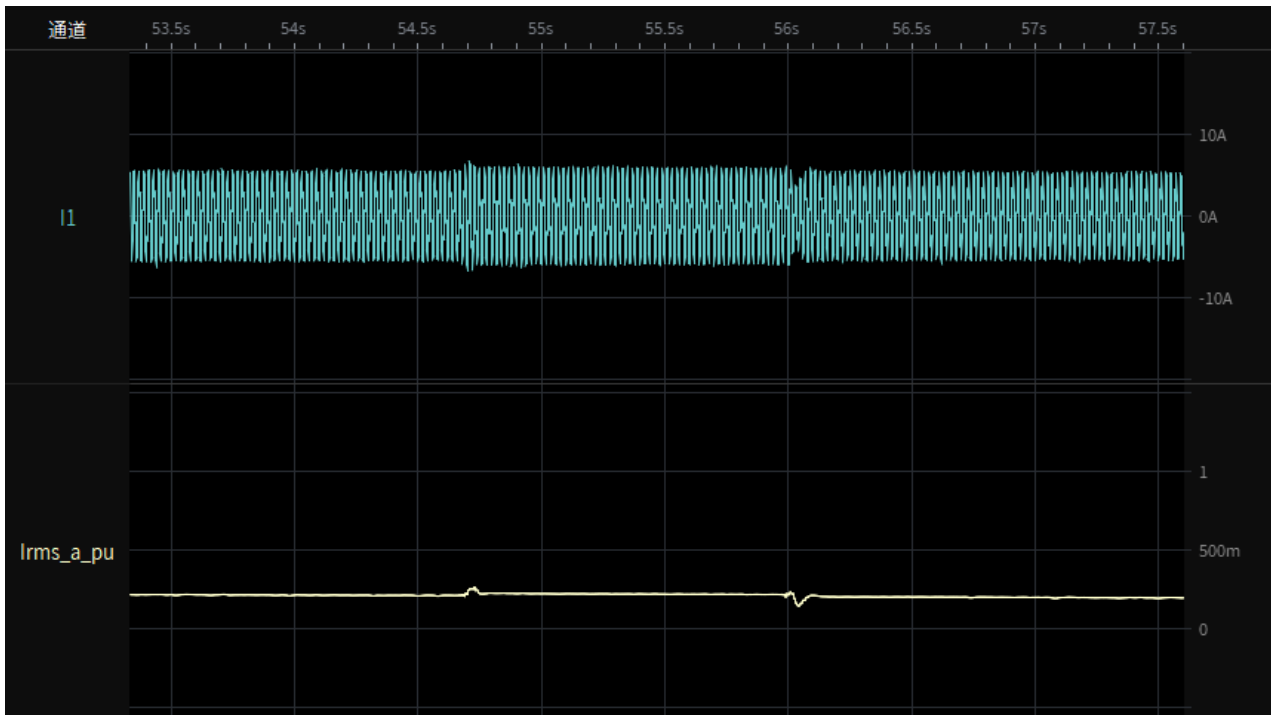

Test 4a-1.4 Depth of fault phase: 0.75p.u.,two-phase-asymmetrical (type D),20% load
restoring time

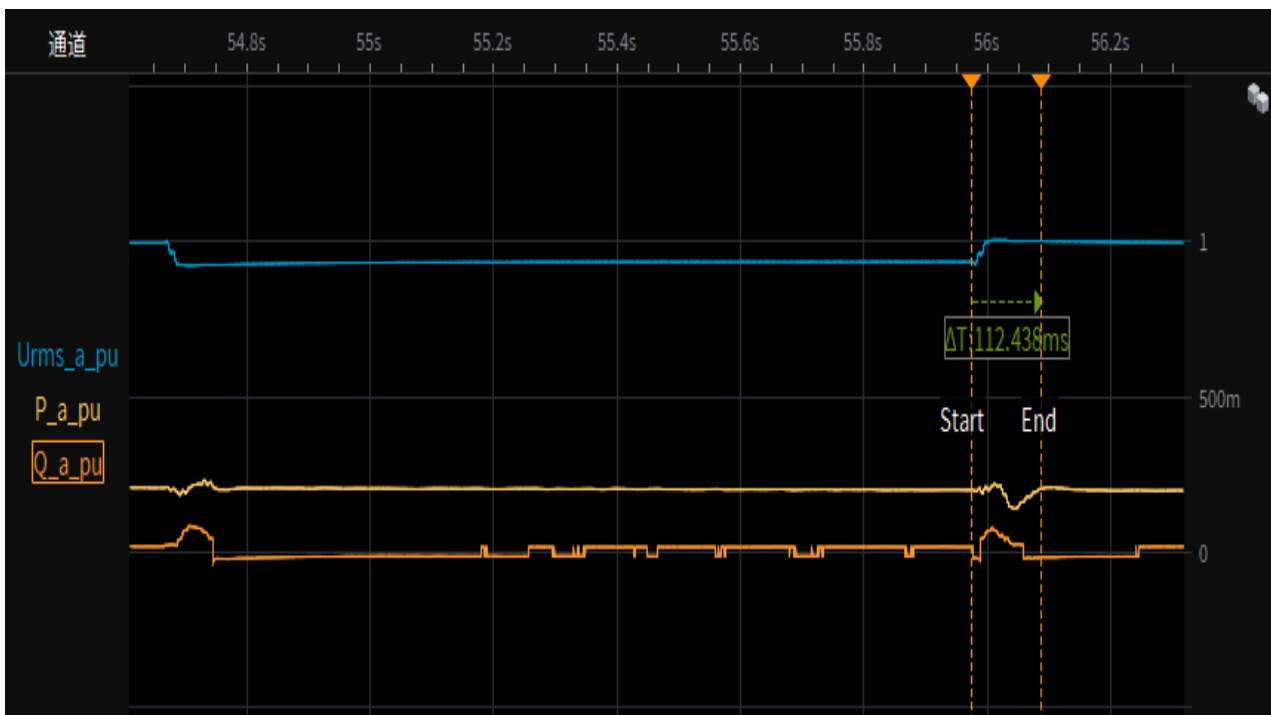

CEI 0-21			
Clause	Requirement - Test	Result - Remark	Verdict

Test 4a-2.1 Depth of fault phase: 0.75p.u.,two-phase-asymmetrical (type D),95% load
Test overview(voltage,current,active and reactive power)

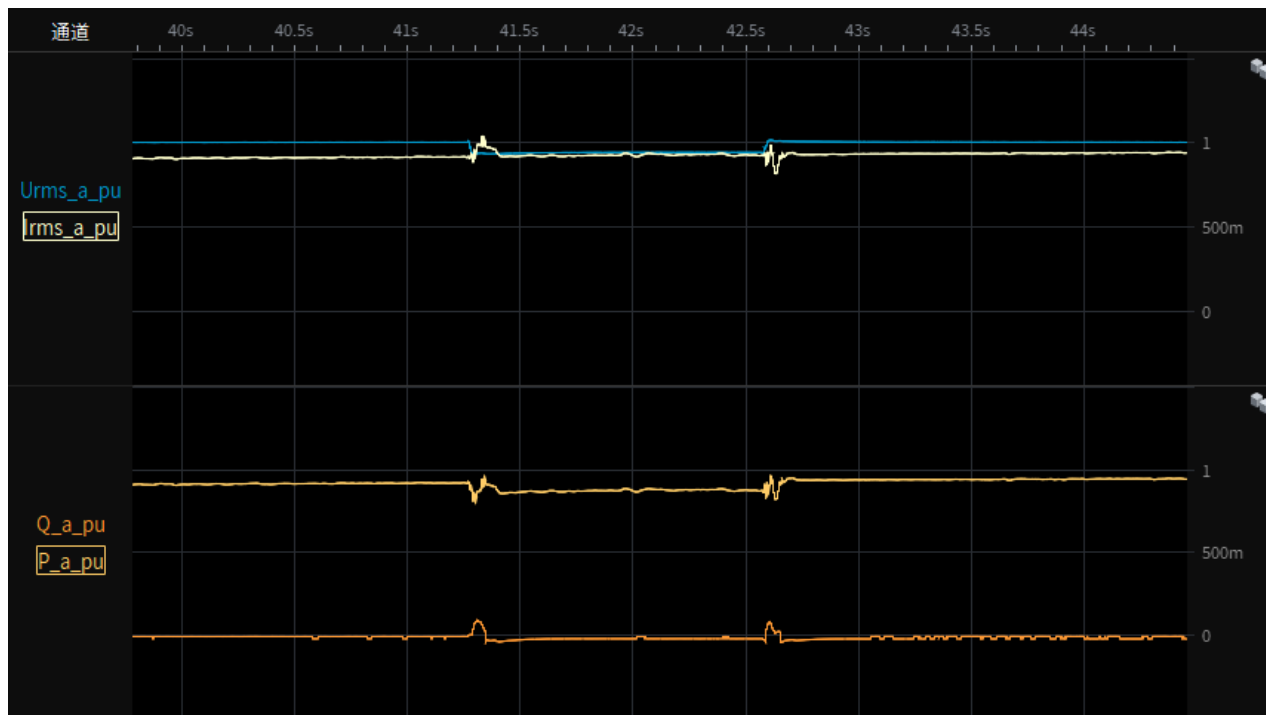

Test 4a-2.2 Depth of fault phase: 0.75p.u.,two-phase-asymmetrical (type D),95% load
Instantaneous curve and RMS value of phase-to-neutral voltages

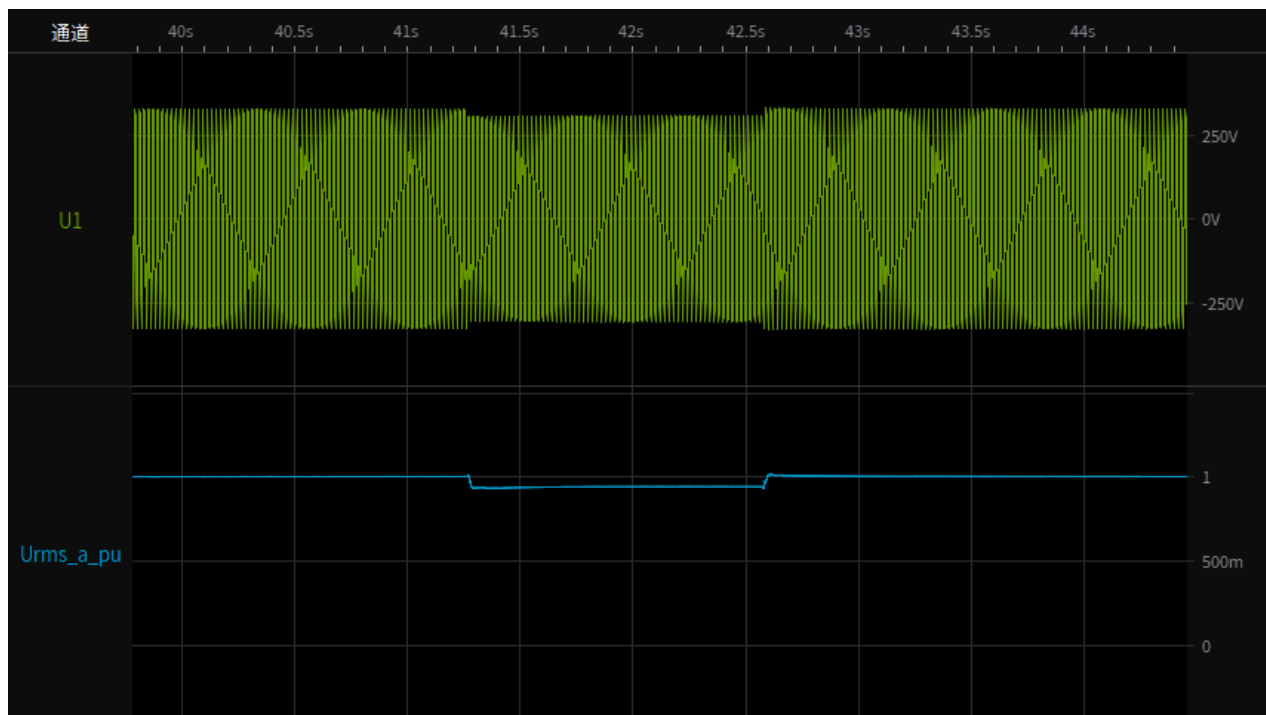

CEI 0-21			
Clause	Requirement - Test	Result - Remark	Verdict

Test 4a-2.3 Depth of fault phase: 0.75p.u.,two-phase-asymmetrical (type D),95% load
Instantaneous curve and RMS value of phase currents

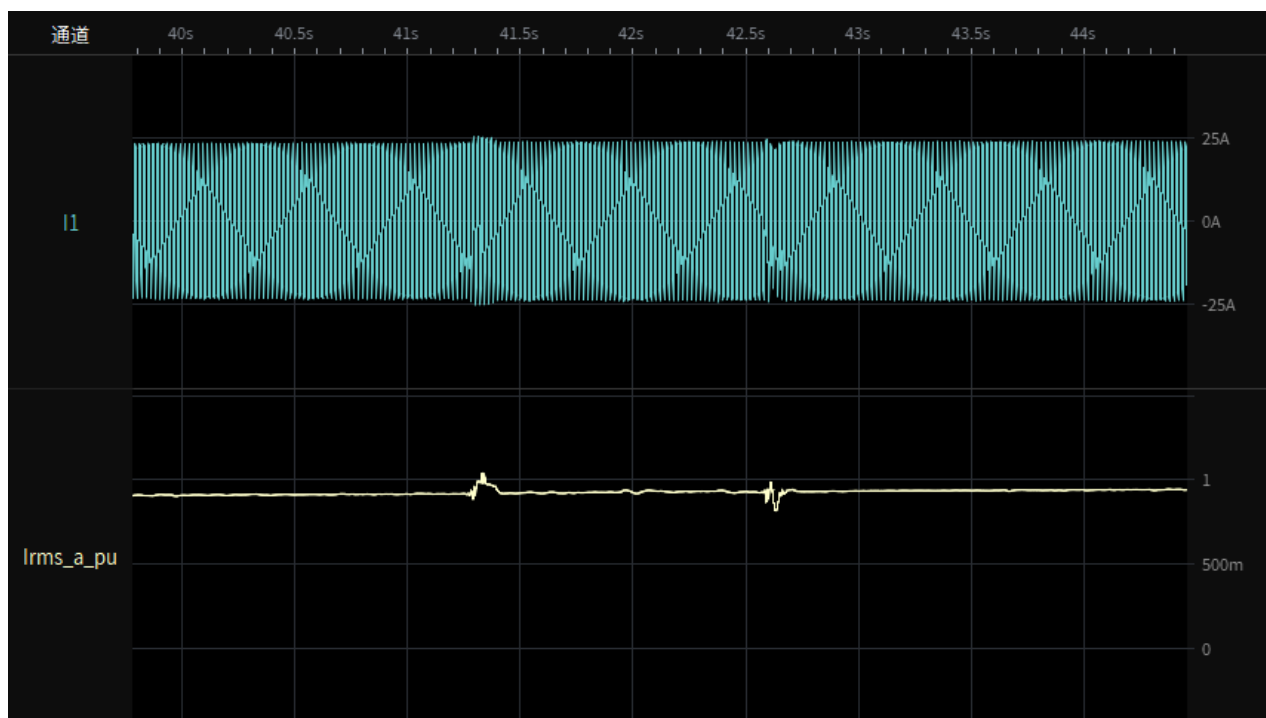

Test 4a-2.4 Depth of fault phase: 0.75p.u.,two-phase-asymmetrical (type D), 95% load
restoring time



CEI 0-21			
Clause	Requirement - Test	Result - Remark	Verdict

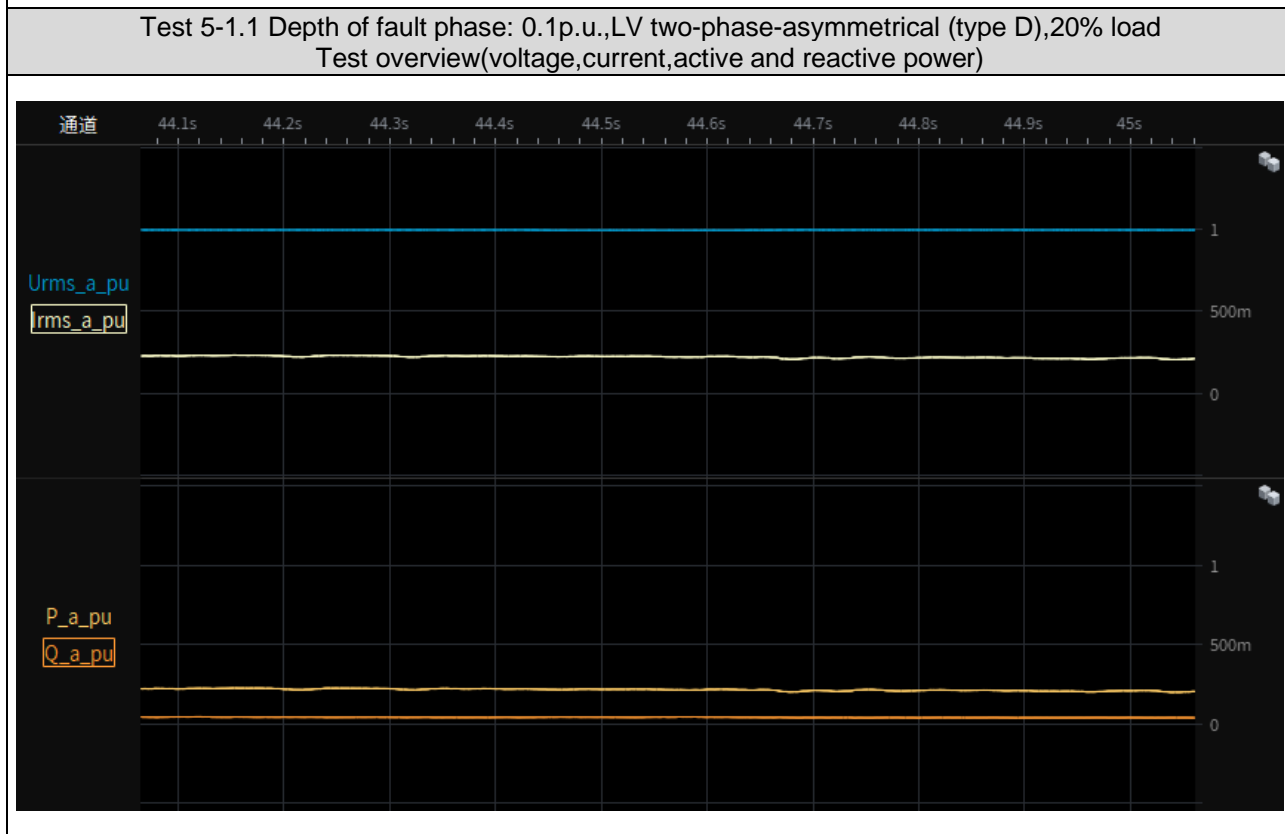
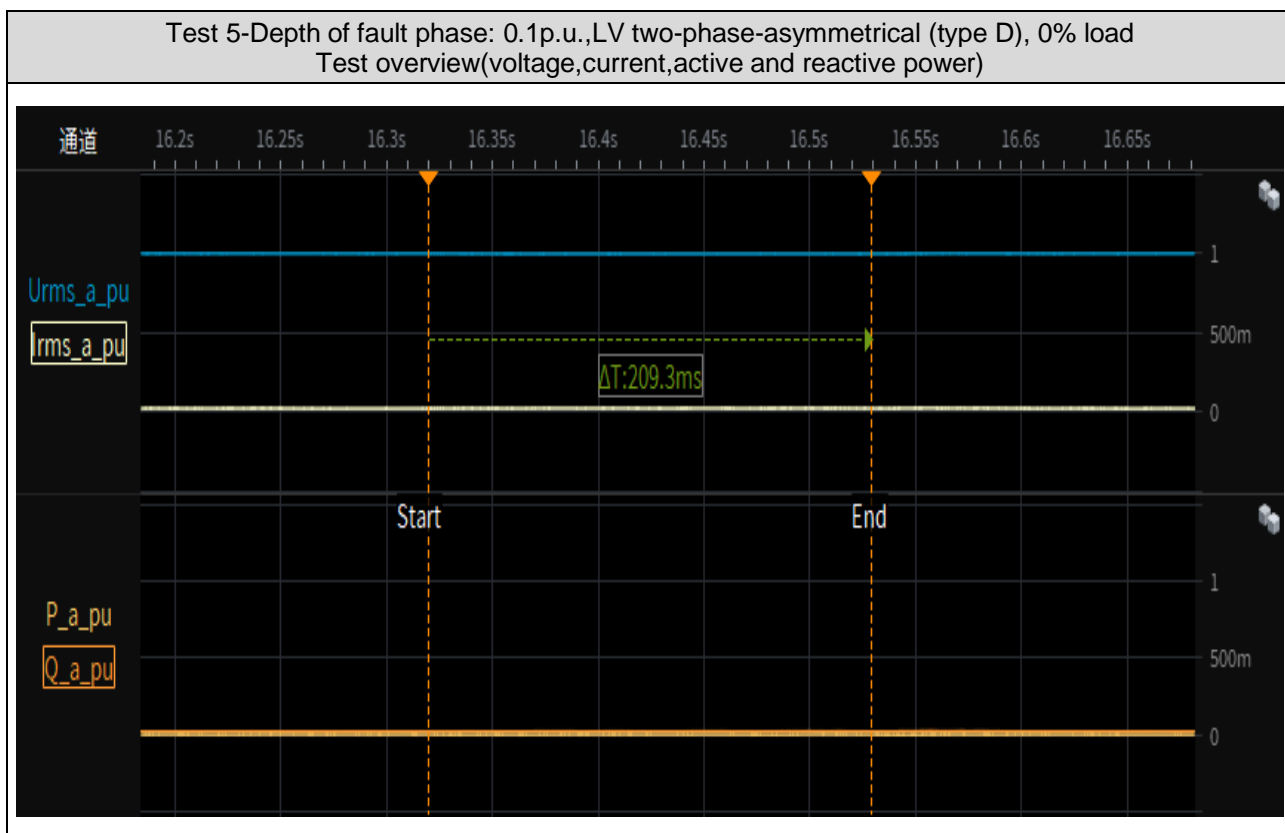

CEI 0-21			
Clause	Requirement - Test	Result - Remark	Verdict

Test 5-1.2 Depth of fault phase: 0.1p.u.,LV two-phase-asymmetrical (type D),20% load
Instantaneous curve and RMS value of phase-to-neutral voltages

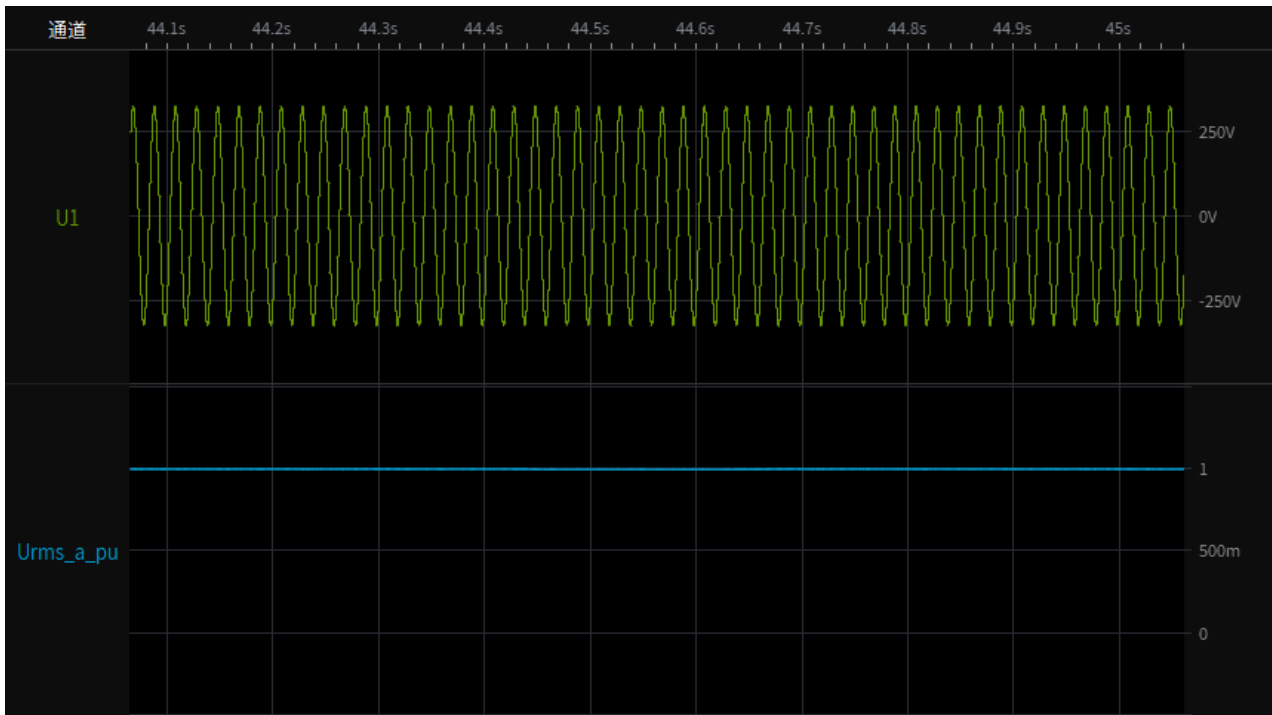

Test 5-1.3 Depth of fault phase: 0.1p.u.,LV two-phase-asymmetrical (type D),20% load
Instantaneous curve and RMS value of phase currents

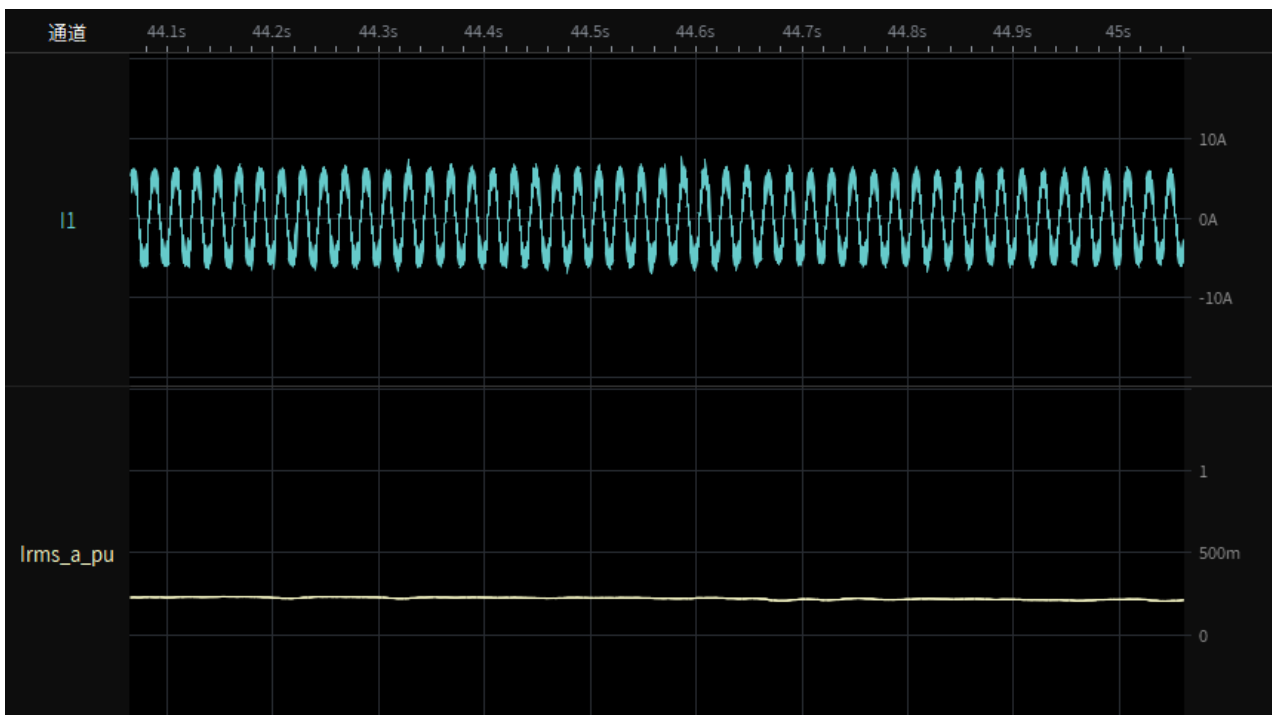

CEI 0-21			
Clause	Requirement - Test	Result - Remark	Verdict

Test 5-1.4 Depth of fault phase: 0.1p.u.,LV two-phase-asymmetrical (type D),20% load restoring time

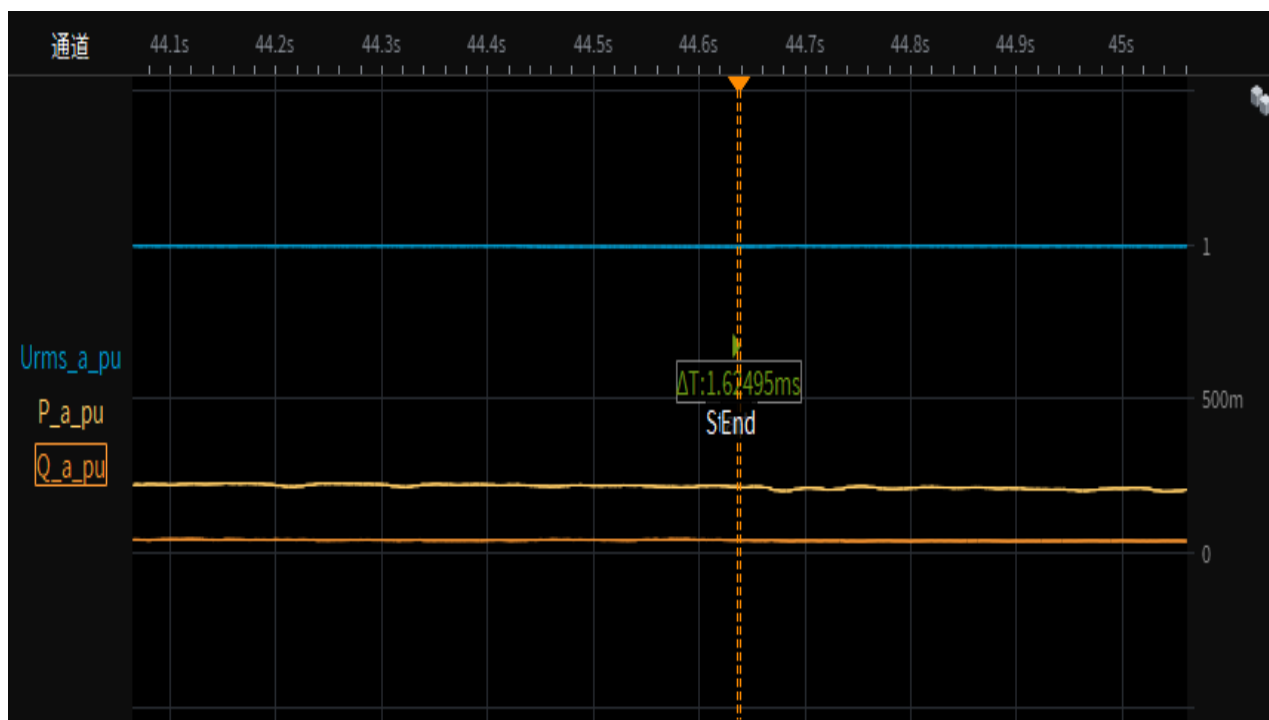

Test 5-2.1 Depth of fault phase: 0.1p.u.,LV two-phase-asymmetrical (type D),95% load Test overview(voltage,current,active and reactive power)

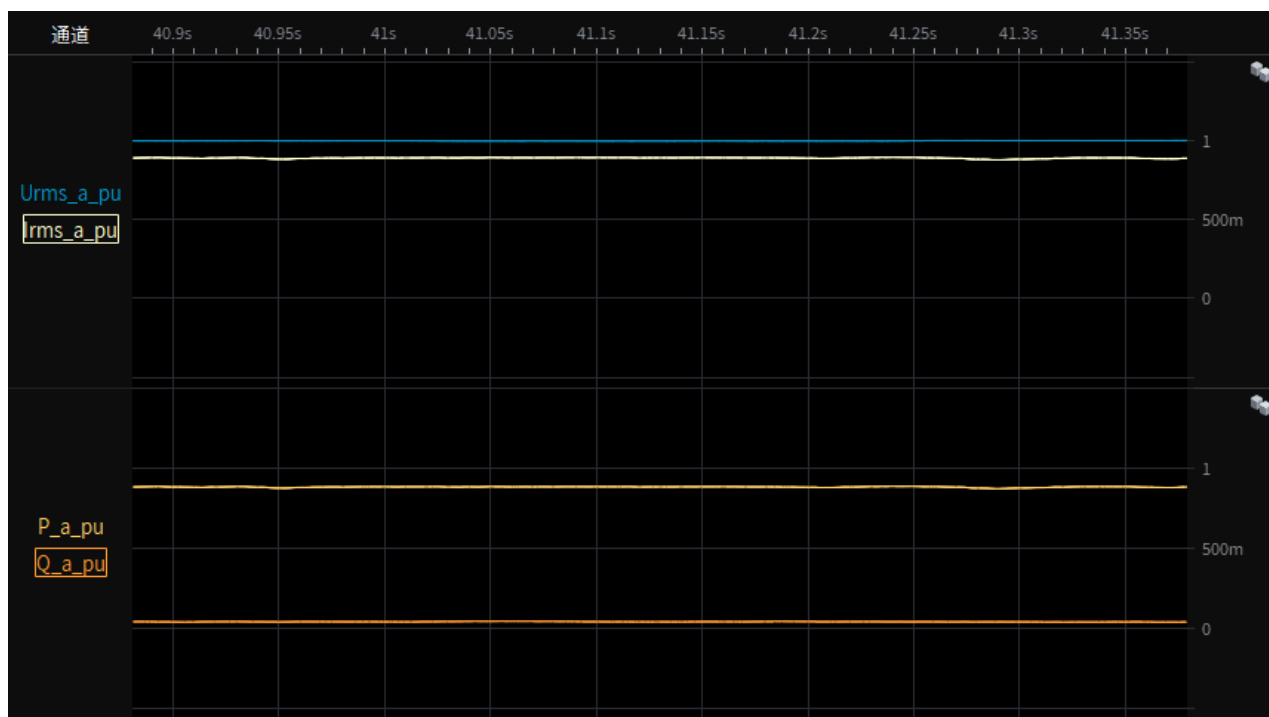

CEI 0-21			
Clause	Requirement - Test	Result - Remark	Verdict

Test 5-2.2 Depth of fault phase: 0.1p.u., LV two-phase-asymmetrical (type D), 95% load
Instantaneous curve and RMS value of phase-to-neutral voltages

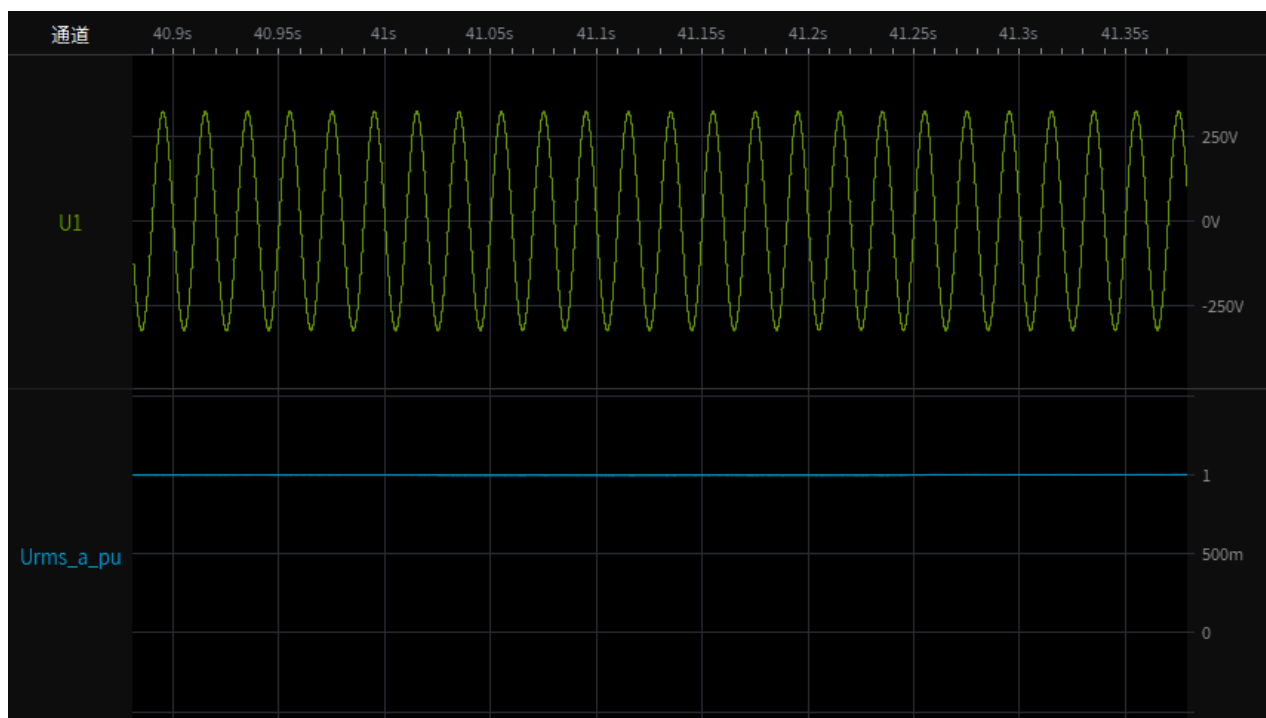

Test 5-2.3 Depth of fault phase: 0.1p.u., LV two-phase-asymmetrical (type D), 95% load
Instantaneous curve and RMS value of phase currents

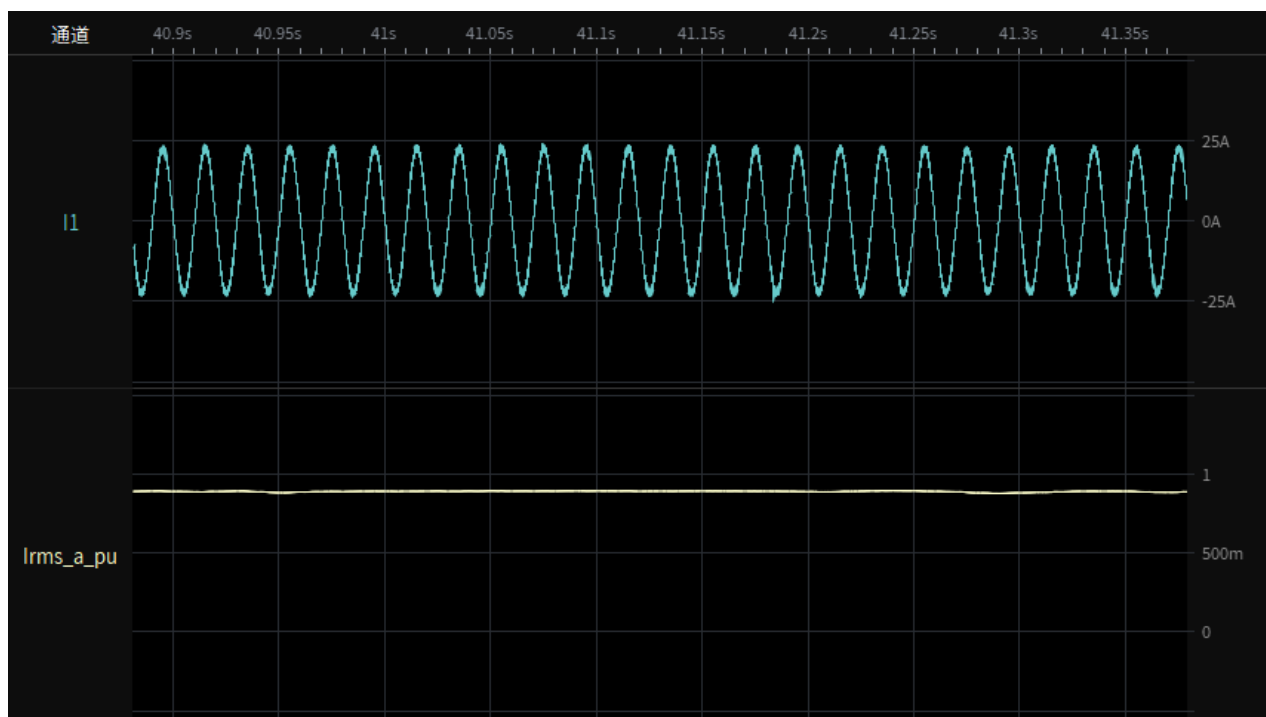

CEI 0-21			
Clause	Requirement - Test	Result - Remark	Verdict

Test 5-2.4 Depth of fault phase: 0.1p.u.,LV two-phase-asymmetrical (type D), 95% load restoring time

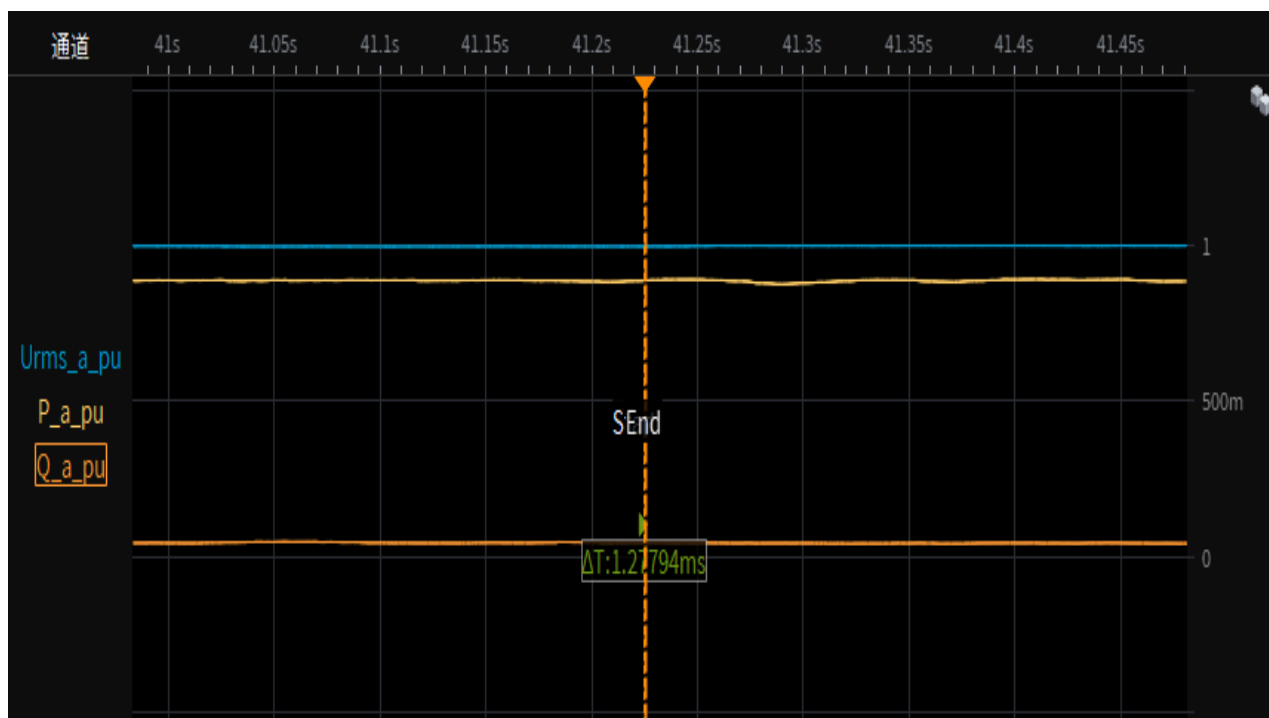

Test 6-Depth of fault phase: 0.5p.u.,LV two-phase-asymmetrical (type D), 0% load Test overview(voltage,current,active and reactive power)

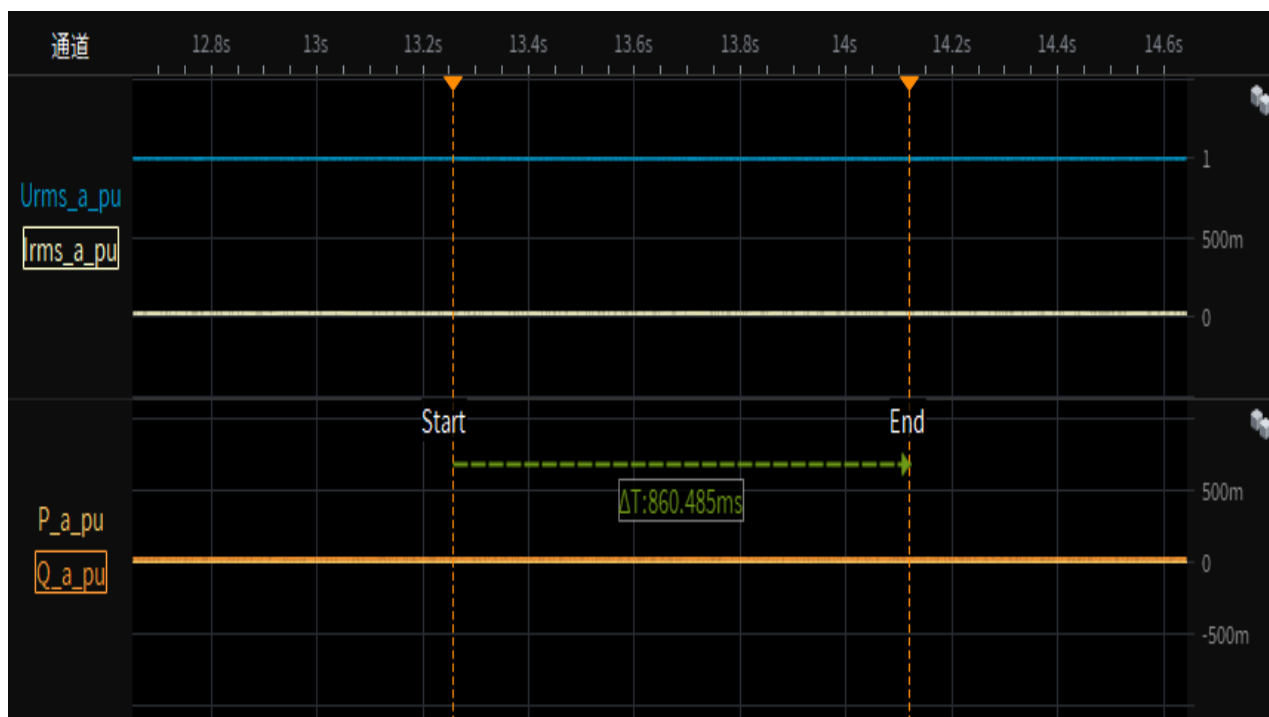

CEI 0-21			
Clause	Requirement - Test	Result - Remark	Verdict

Test 6-1.1 Depth of fault phase: 0.5p.u., LV two-phase-asymmetrical (type D), 20% load
 Test overview(voltage,current,active and reactive power)

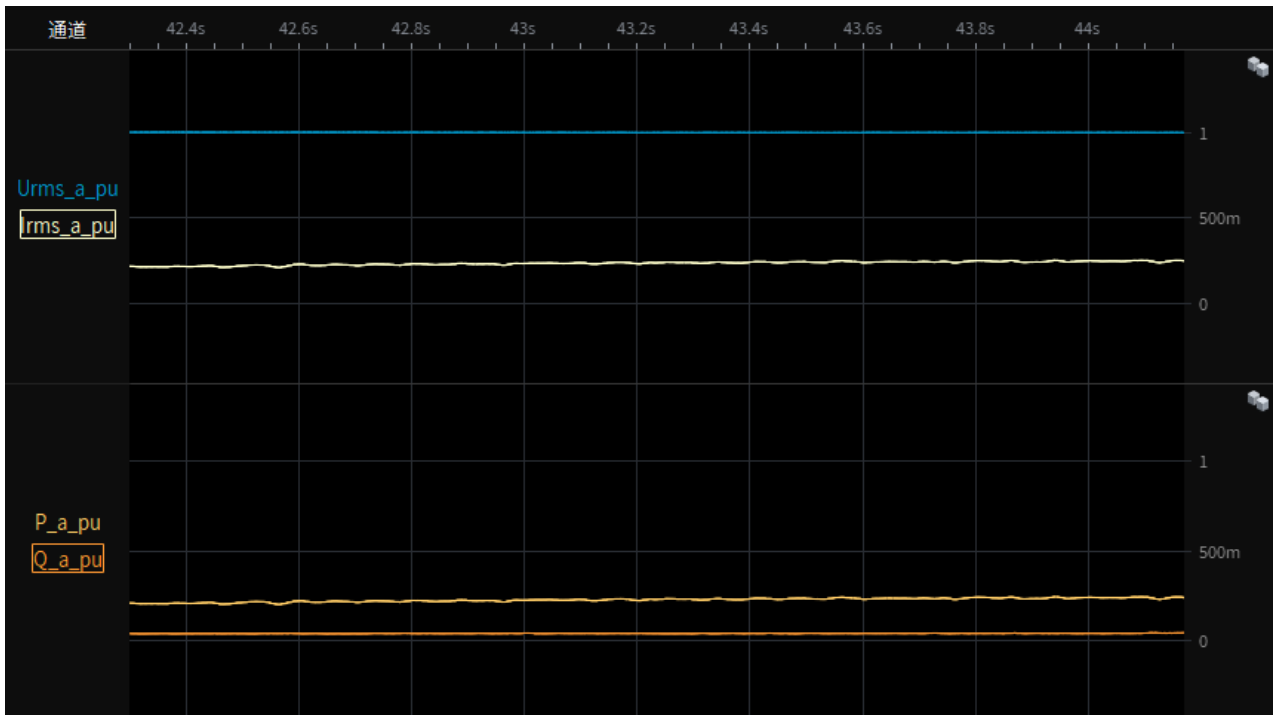

Test 6-1.2 Depth of fault phase: 0.5p.u., LV two-phase-asymmetrical (type D), 20% load
 Instantaneous curve and RMS value of phase-to-neutral voltages

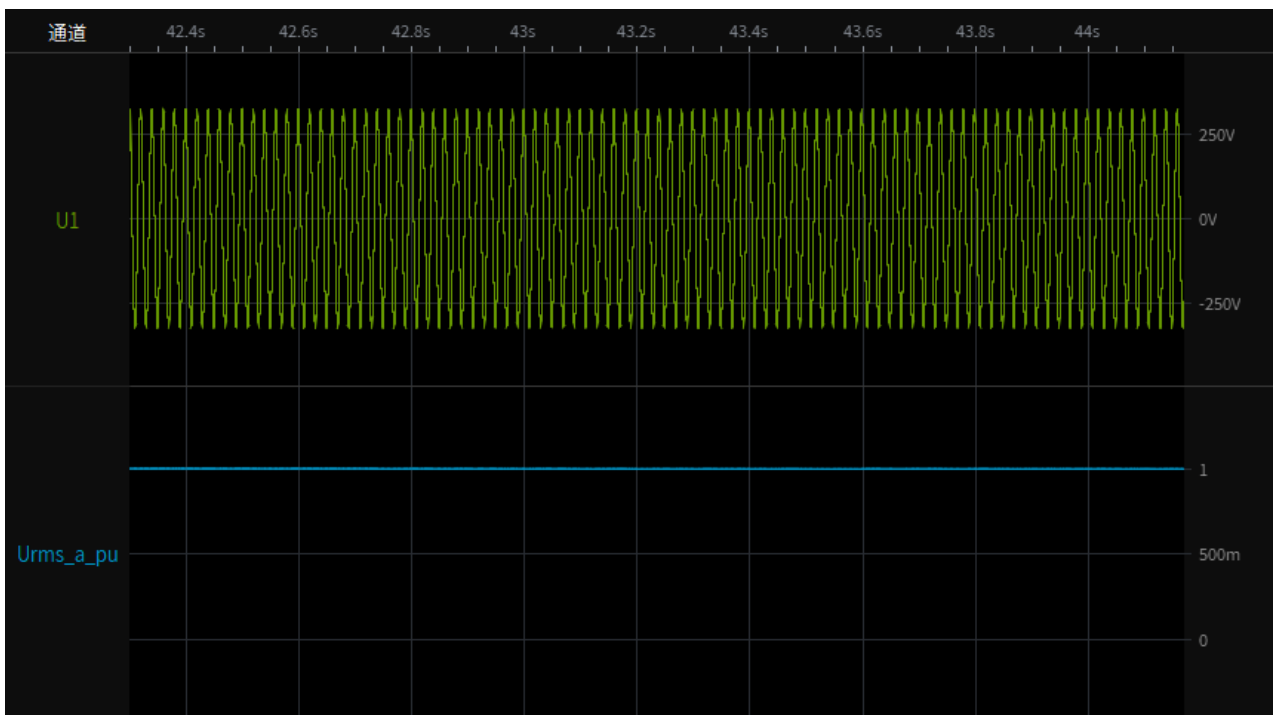

CEI 0-21			
Clause	Requirement - Test	Result - Remark	Verdict

Test 6-1.3 Depth of fault phase: 0.5p.u., LV two-phase-asymmetrical (type D), 20% load
Instantaneous curve and RMS value of phase currents

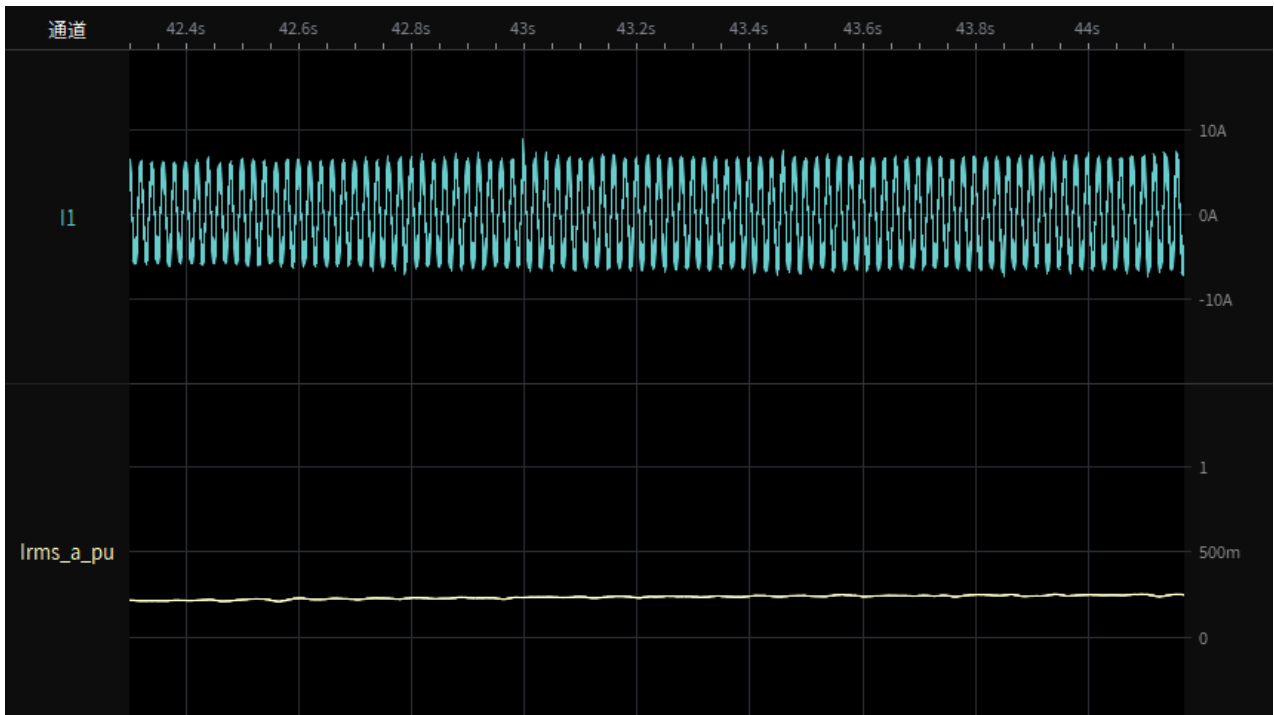

Test 6-1.4 Depth of fault phase: 0.5p.u., LV two-phase-asymmetrical (type D), 20% load
restoring time

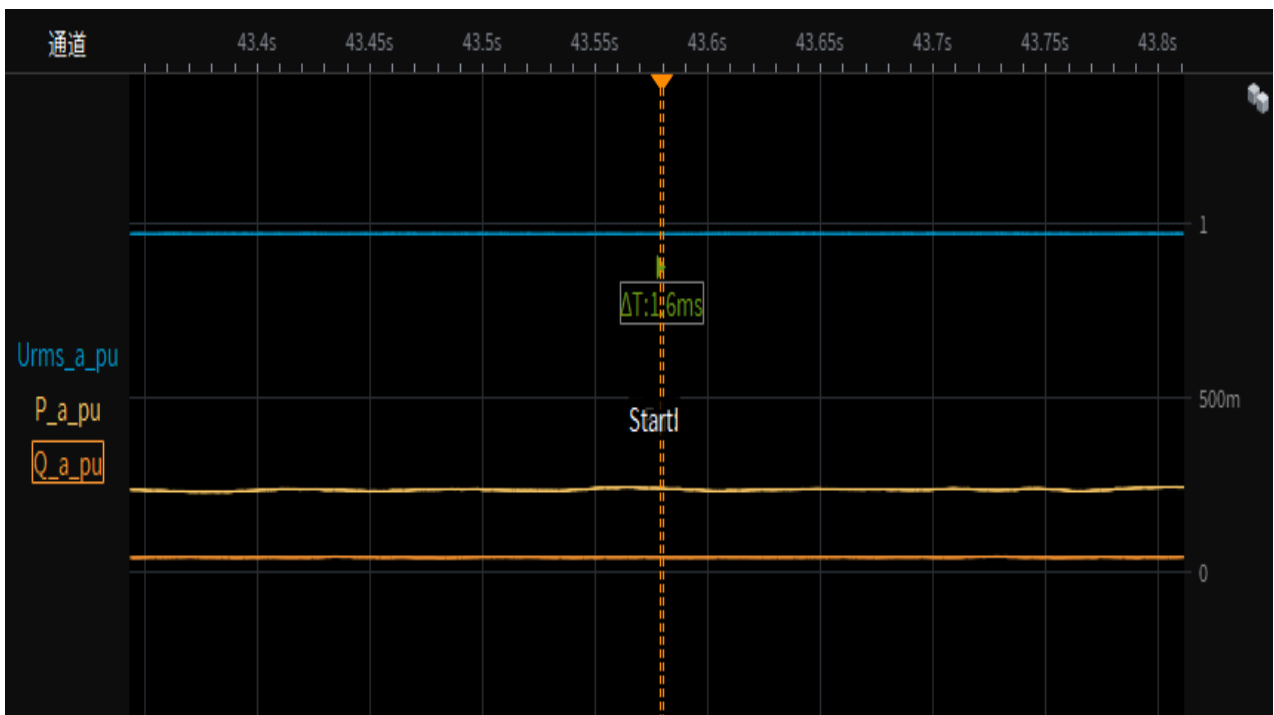

CEI 0-21			
Clause	Requirement - Test	Result - Remark	Verdict

Test 6-2.1 Depth of fault phase: 0.5p.u., LV two-phase-asymmetrical (type D), 95% load
 Test overview(voltage,current,active and reactive power)

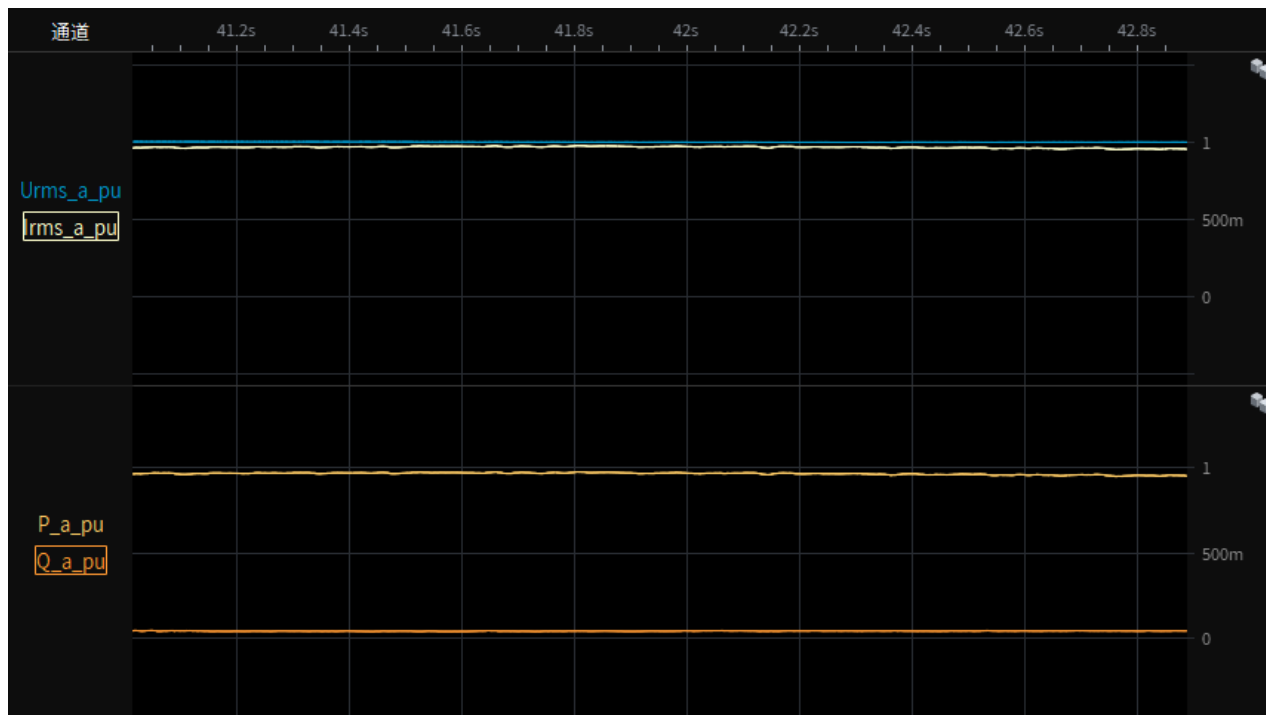

Test 6-2.2 Depth of fault phase: 0.5p.u., LV two-phase-asymmetrical (type D), 95% load
 Instantaneous curve and RMS value of phase-to-neutral voltages

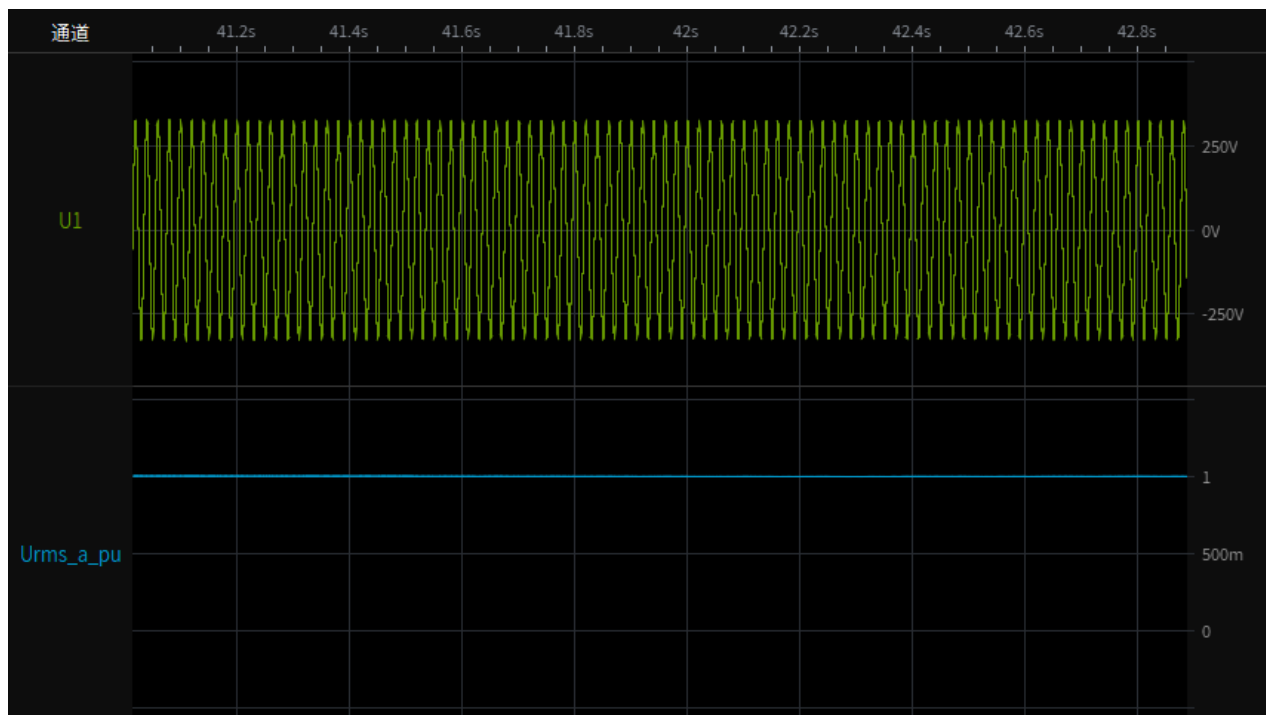

CEI 0-21			
Clause	Requirement - Test	Result - Remark	Verdict

Test 6-2.3 Depth of fault phase: 0.5p.u., LV two-phase-asymmetrical (type D), 95% load
Instantaneous curve and RMS value of phase currents

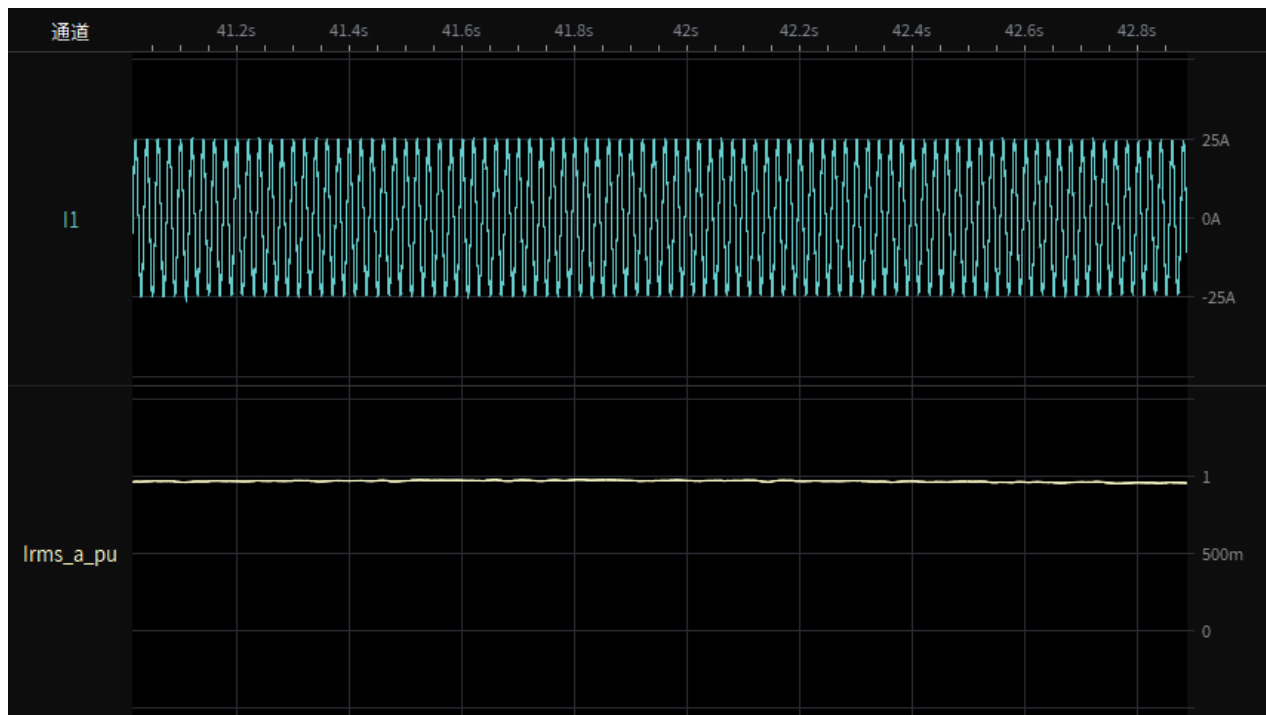

Test 6-2.4 Depth of fault phase: 0.5p.u., LV two-phase-asymmetrical (type D), 95% load
restoring time

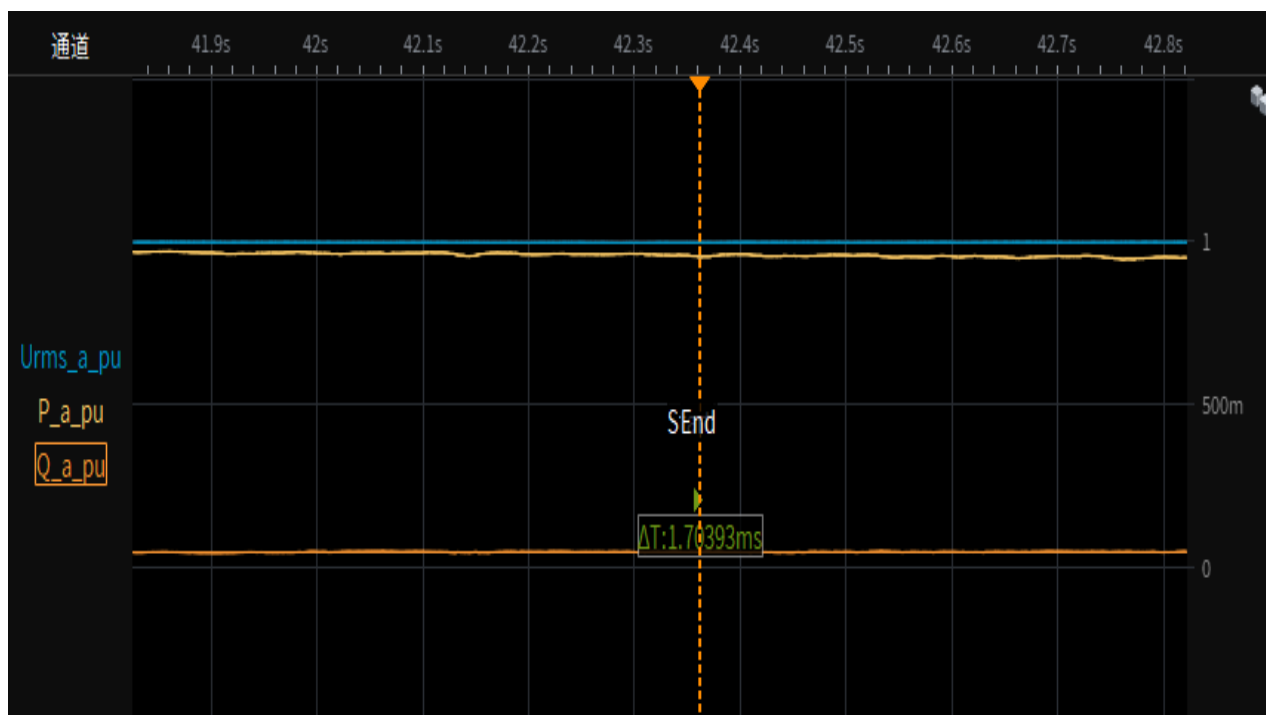

CEI 0-21			
Clause	Requirement - Test	Result - Remark	Verdict

Test 7-Depth of fault phase: 1.20p.u.,three-phase-symmetrical (type A), 0% load
Test overview(voltage,current,active and reactive power)

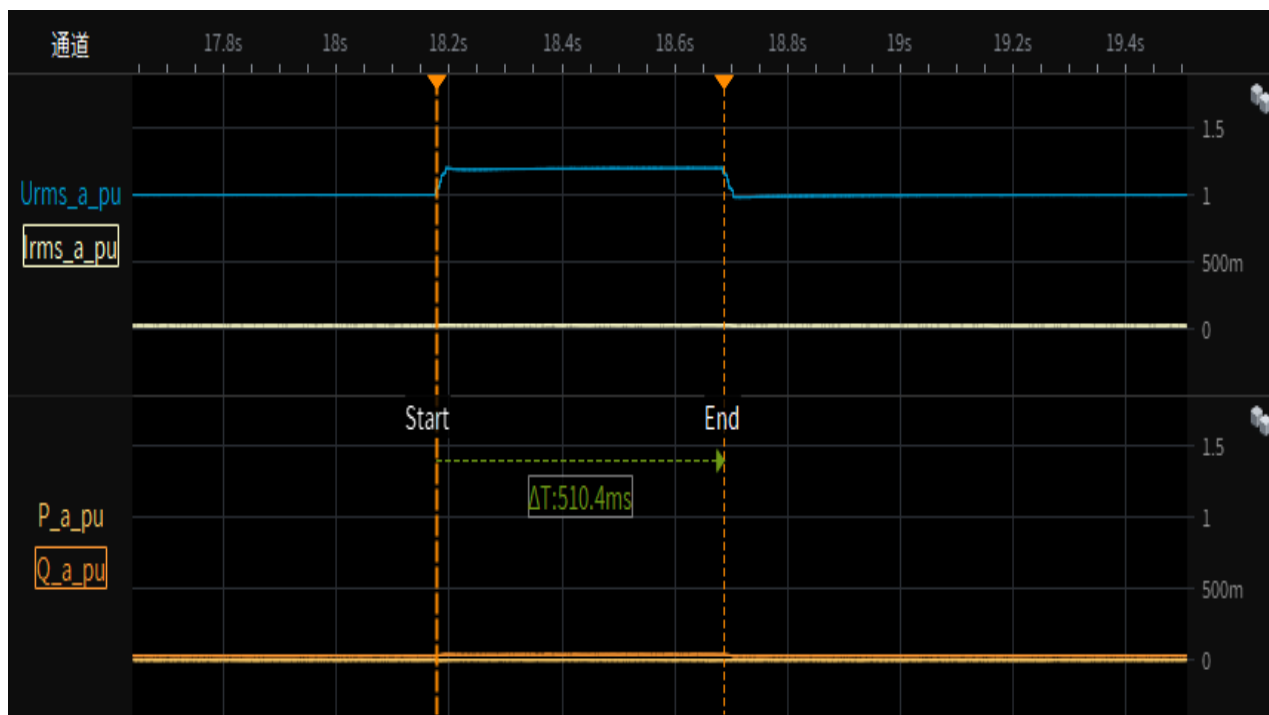

Test 7-1.1 Depth of fault phase: 1.20p.u.,three-phase-symmetrical (type A),20% load
Test overview(voltage,current,active and reactive power)

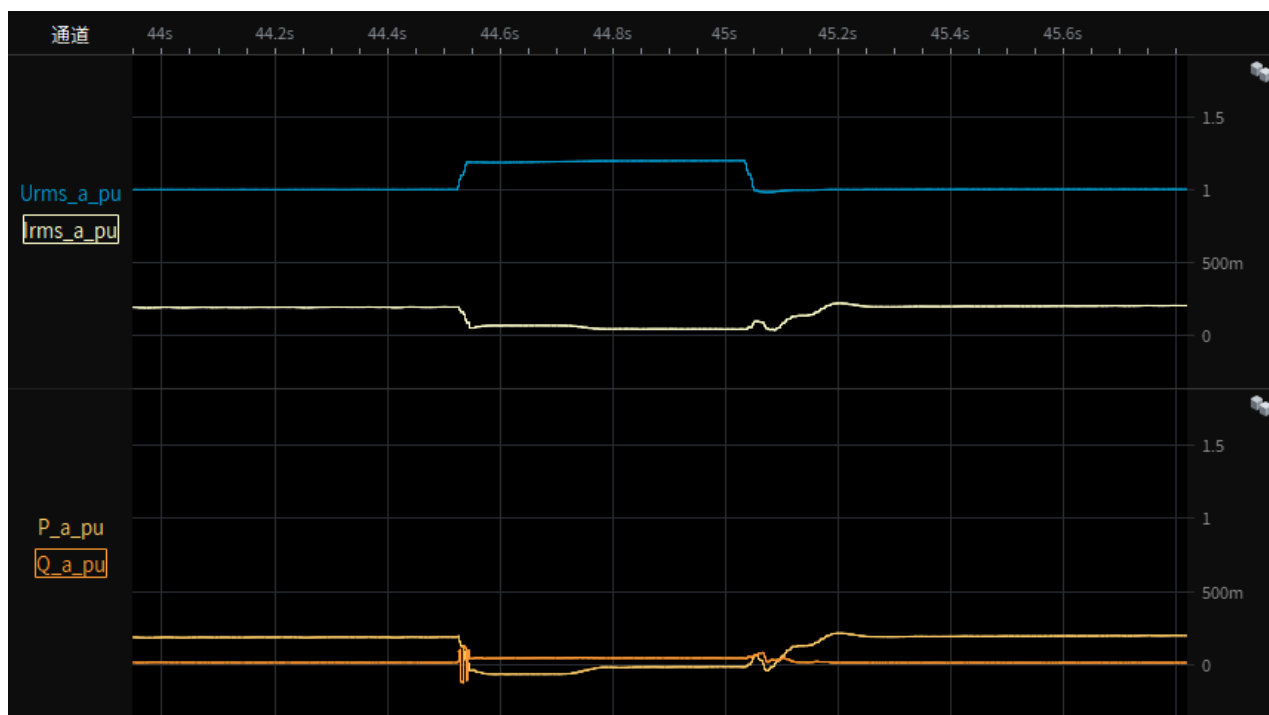

CEI 0-21			
Clause	Requirement - Test	Result - Remark	Verdict

Test 7-1.2 Depth of fault phase: 1.20p.u.,three-phase-symmetrical (type A),20% load
Instantaneous curve and RMS value of phase-to-neutral voltages

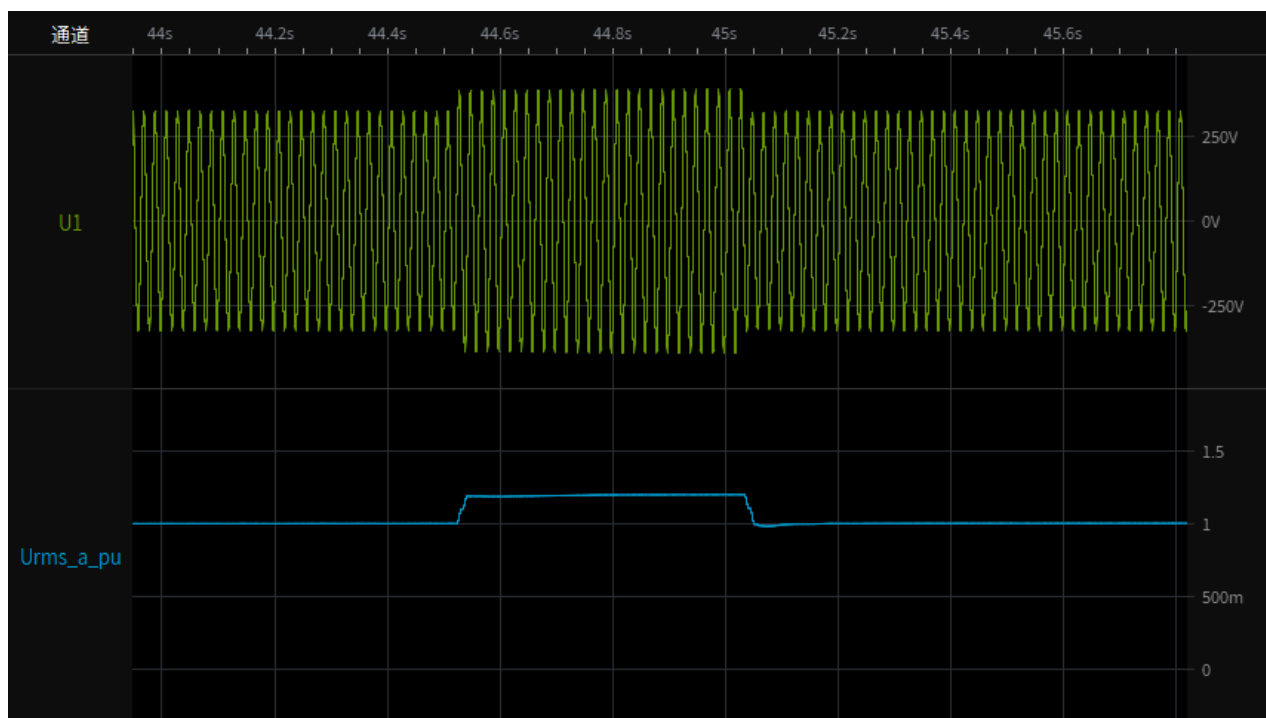

Test 7-1.3 Depth of fault phase: 1.20p.u.,three-phase-symmetrical (type A),20% load
Instantaneous curve and RMS value of phase currents

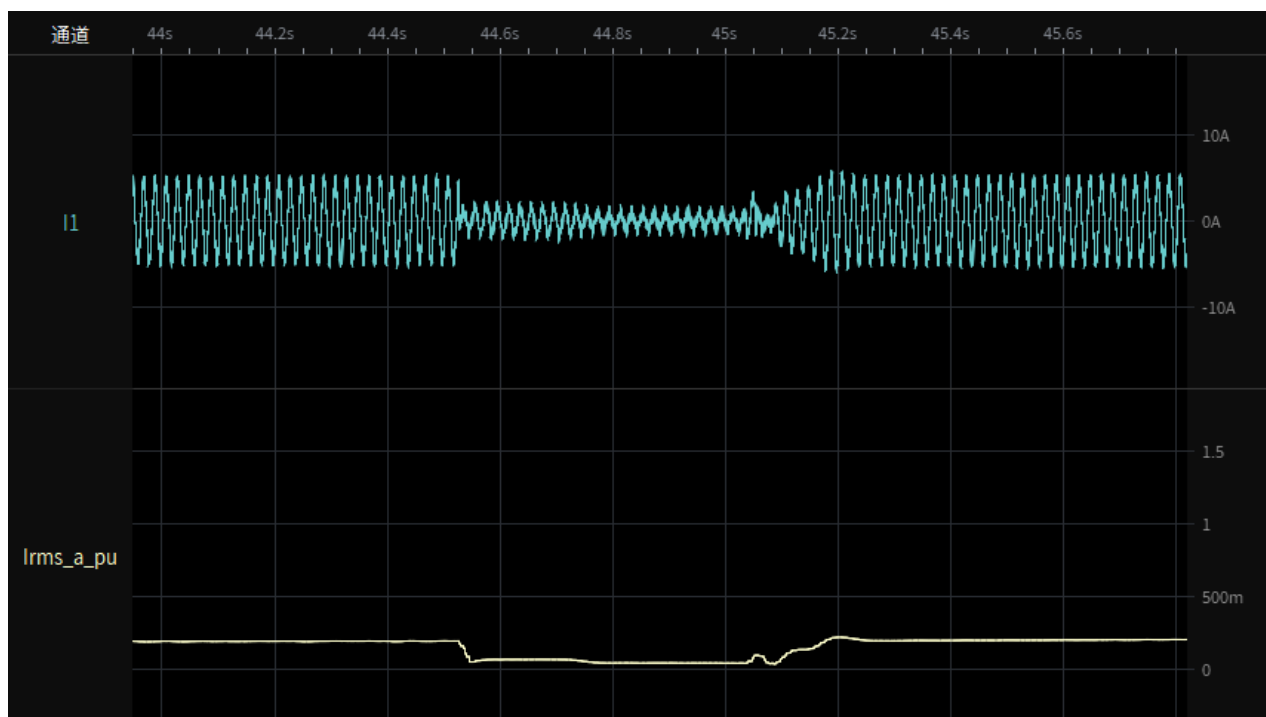

CEI 0-21			
Clause	Requirement - Test	Result - Remark	Verdict

Test 7-1.4 Depth of fault phase: 1.20p.u.,three-phase-symmetrical (type A),20% load restoring time

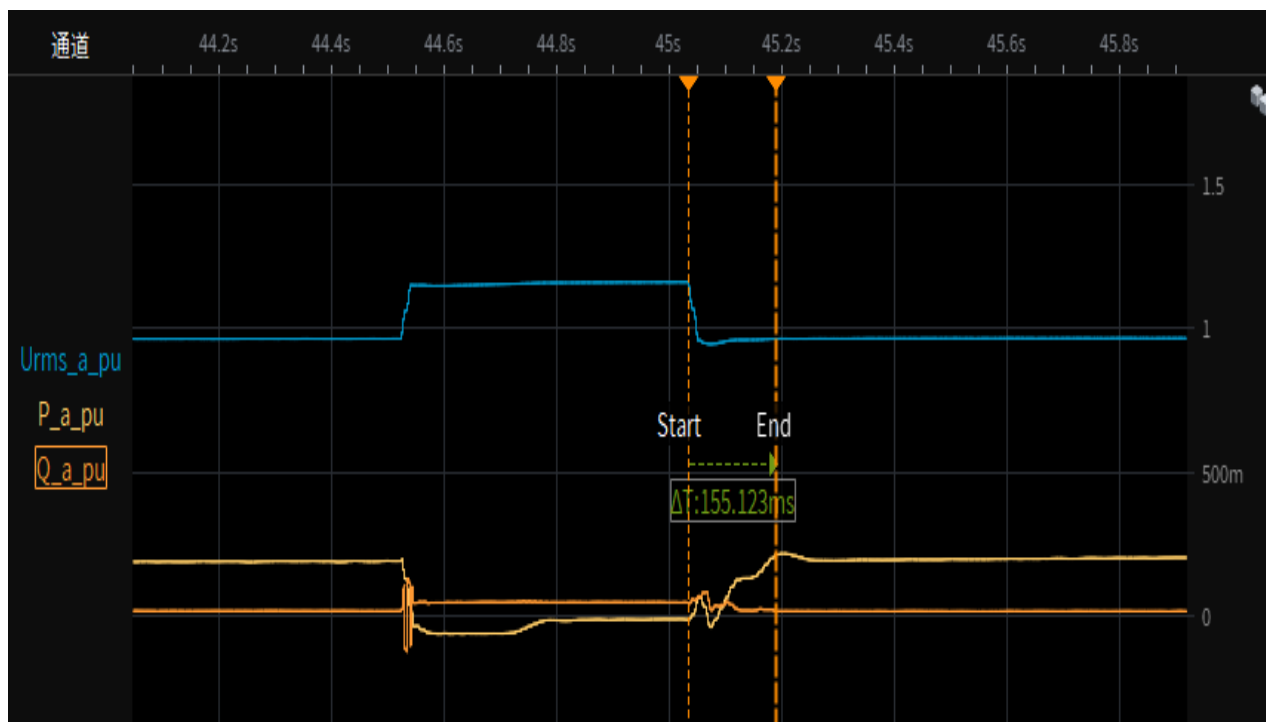

Test 7-2.1 Depth of fault phase: 1.20p.u.,three-phase-symmetrical (type A),95% load Test overview(voltage,current,active and reactive power)

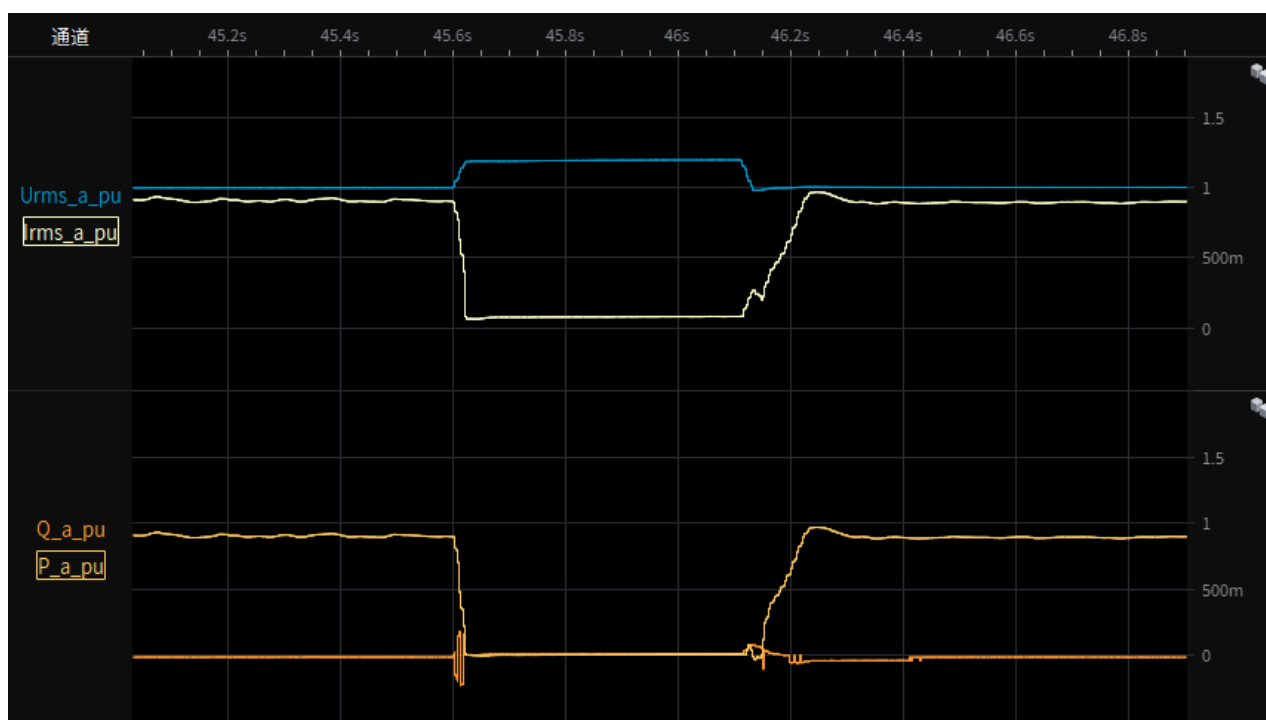

CEI 0-21			
Clause	Requirement - Test	Result - Remark	Verdict

Test 7-2.2 Depth of fault phase: 1.20p.u.,three-phase-symmetrical (type A),95% load
Instantaneous curve and RMS value of phase-to-neutral voltages

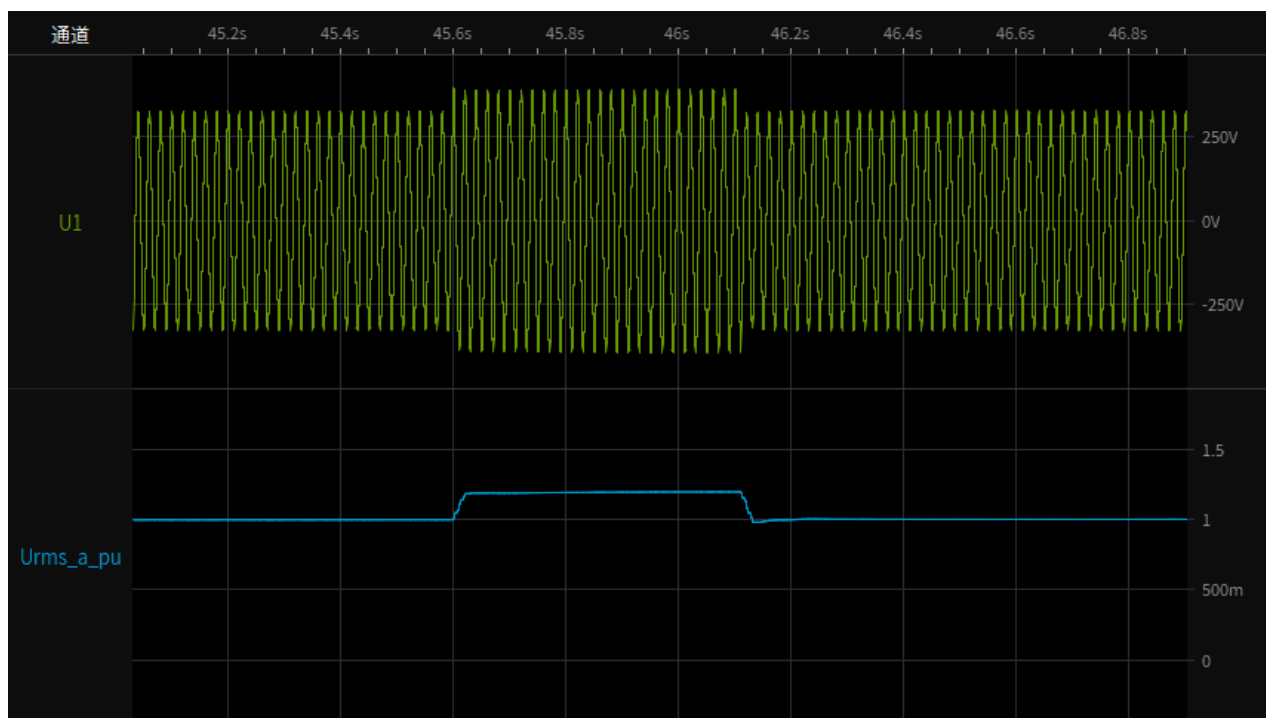

Test 7-2.3 Depth of fault phase: 1.20p.u.,three-phase-symmetrical (type A),95% load
Instantaneous curve and RMS value of phase currents

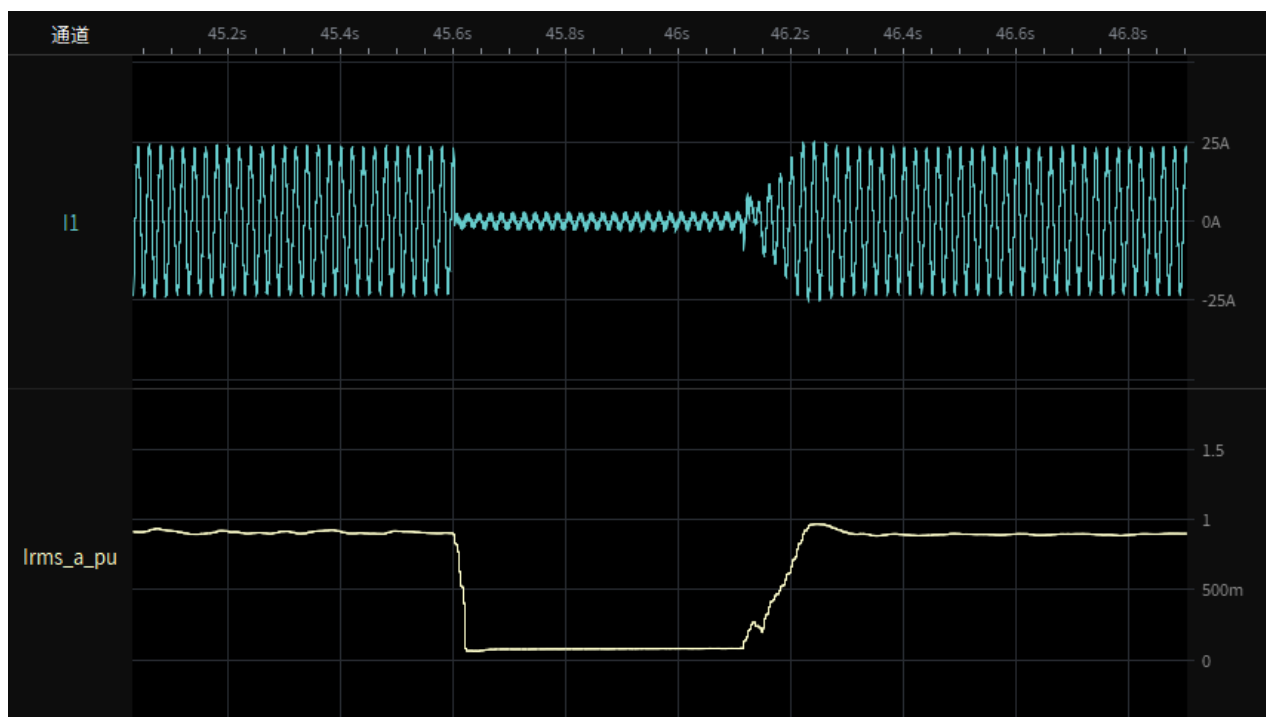

CEI 0-21			
Clause	Requirement - Test	Result - Remark	Verdict

Test 7-2.4 Depth of fault phase: 1.20p.u.,three-phase-symmetrical (type A), 95% load restoring time

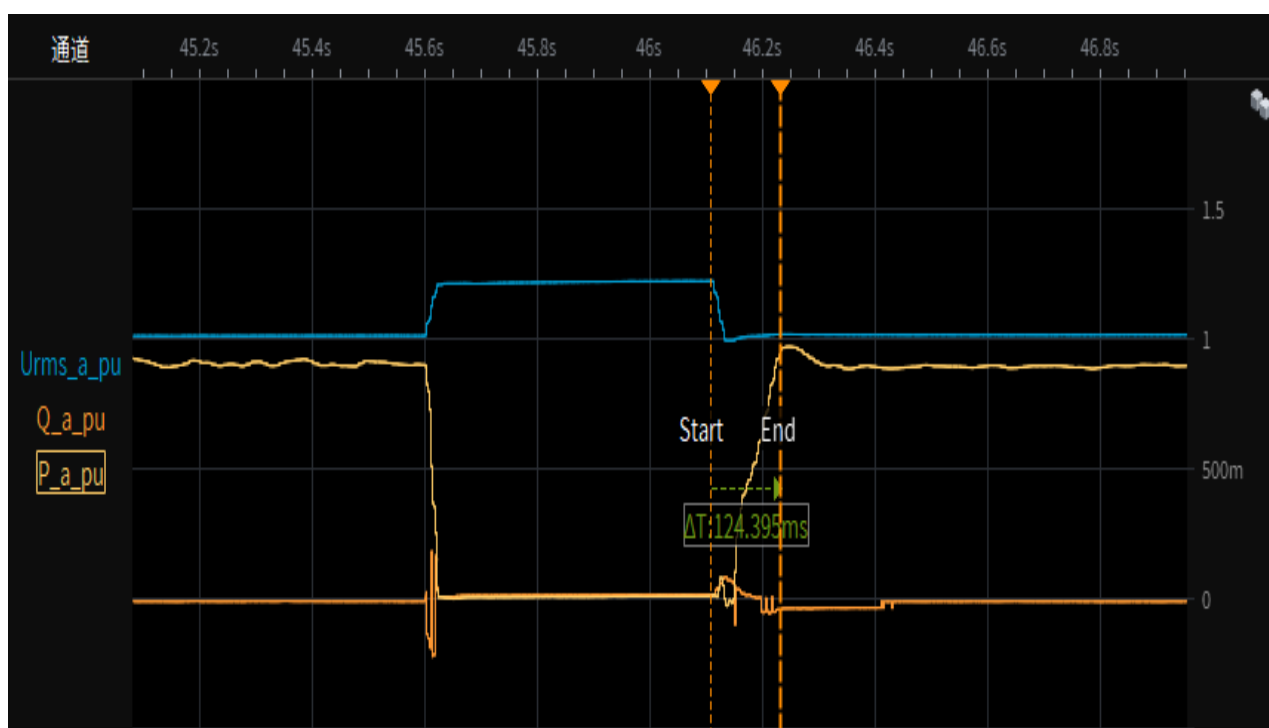

Test 8-Depth of fault phase: 1.25p.u.,three-phase-symmetrical (type A), 0% load Test overview(voltage,current,active and reactive power)

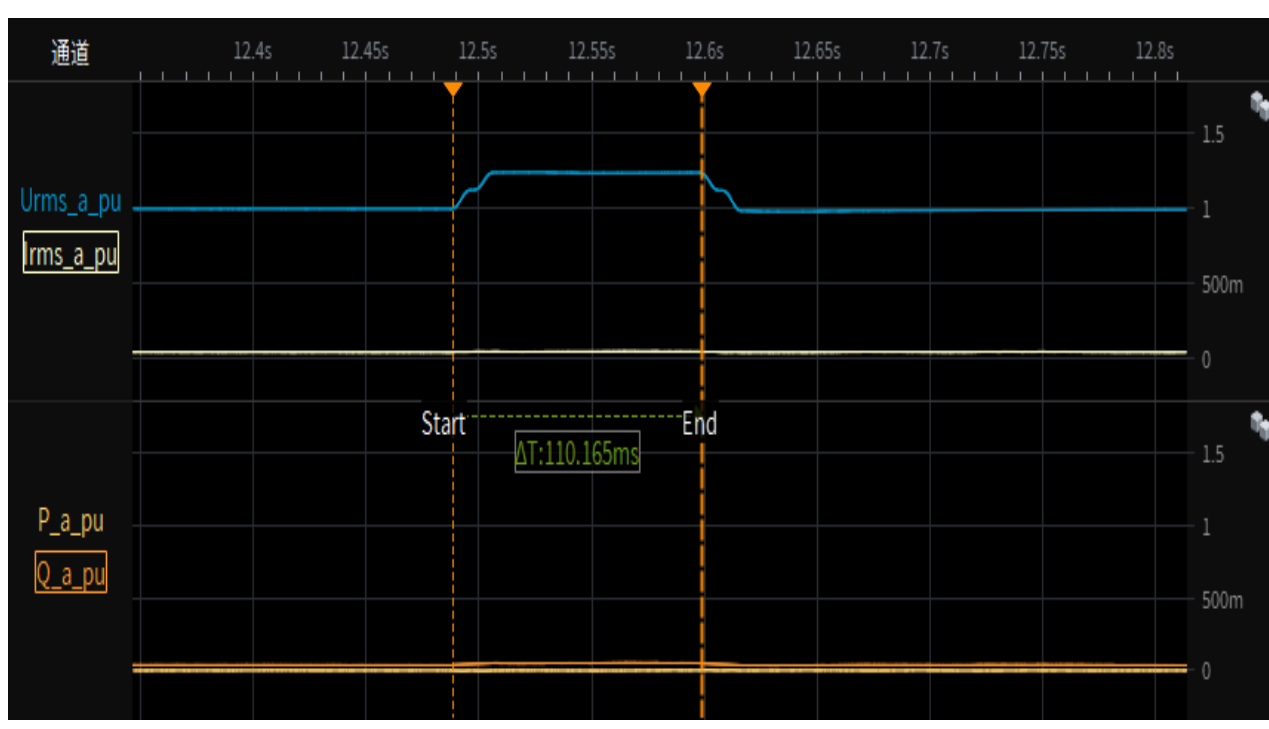

CEI 0-21			
Clause	Requirement - Test	Result - Remark	Verdict

Test 8-1.1 Depth of fault phase: 1.25p.u.,three-phase-symmetrical (type A),20% load
Test overview(voltage,current,active and reactive power)

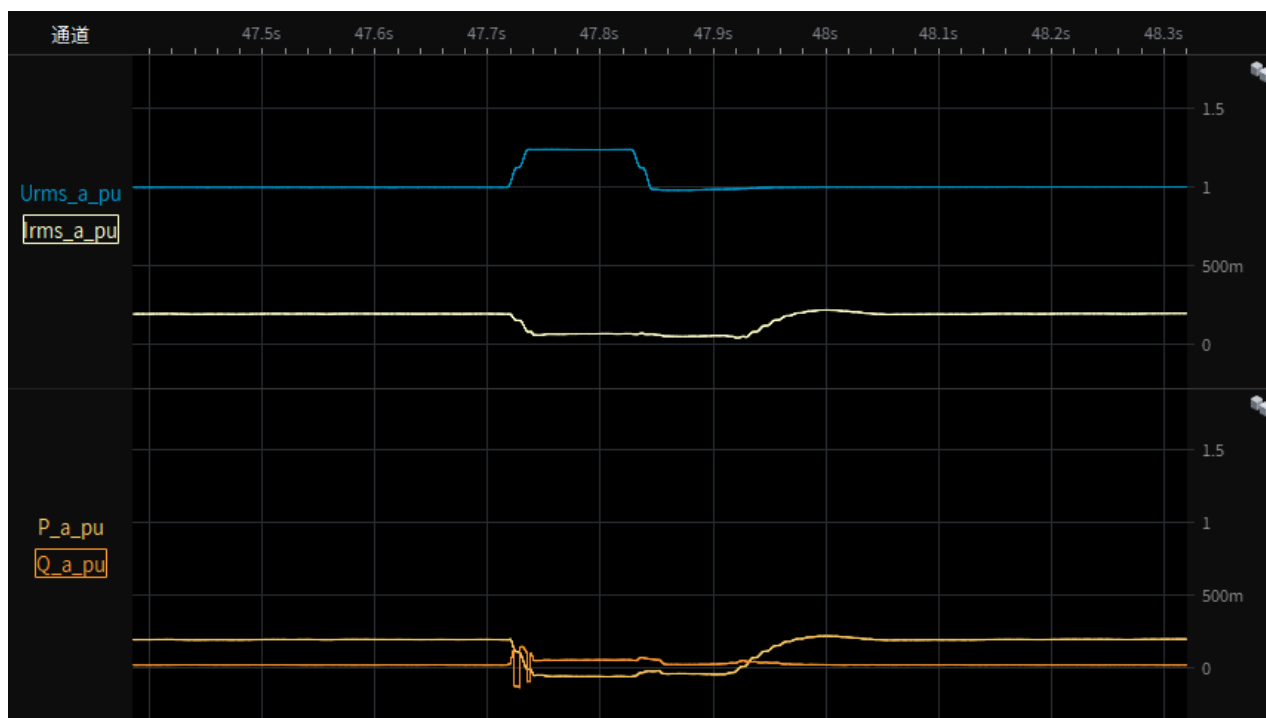

Test 8-1.2 Depth of fault phase: 1.25p.u.,three-phase-symmetrical (type A),20% load
Instantaneous curve and RMS value of phase-to-neutral voltages

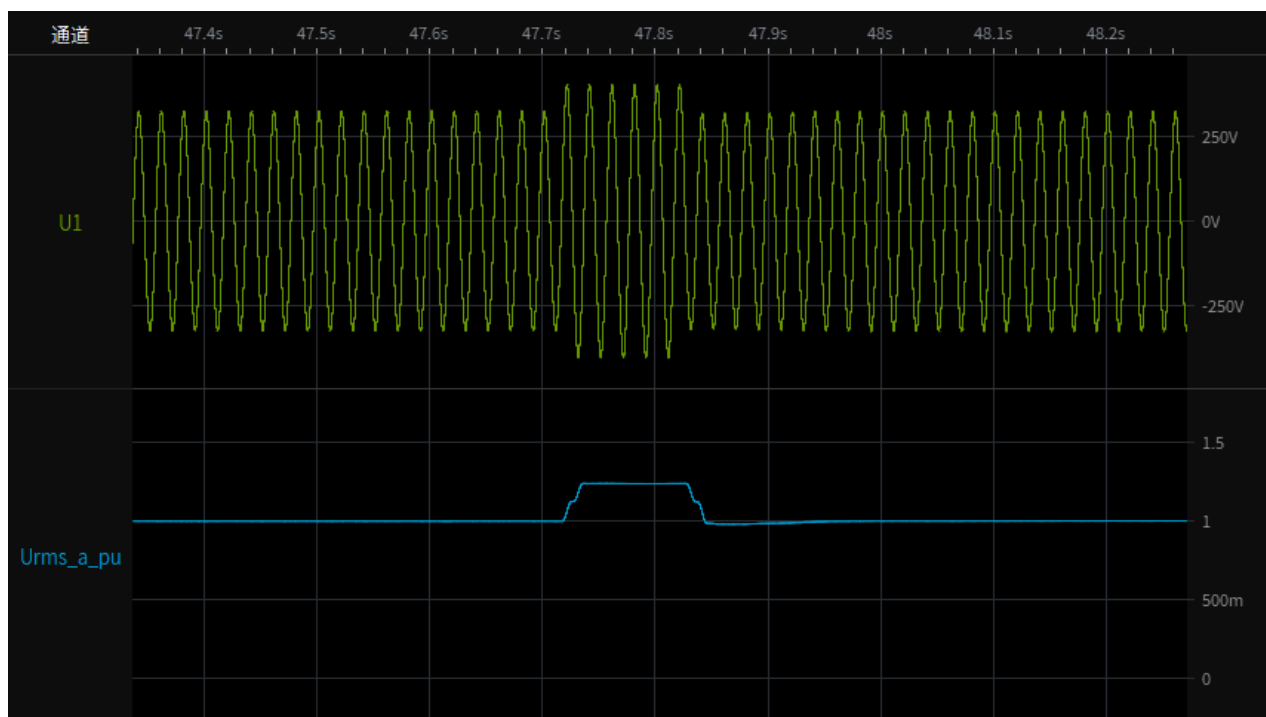

CEI 0-21			
Clause	Requirement - Test	Result - Remark	Verdict

Test 8-1.3 Depth of fault phase: 1.25p.u.,three-phase-symmetrical (type A),20% load
Instantaneous curve and RMS value of phase currents

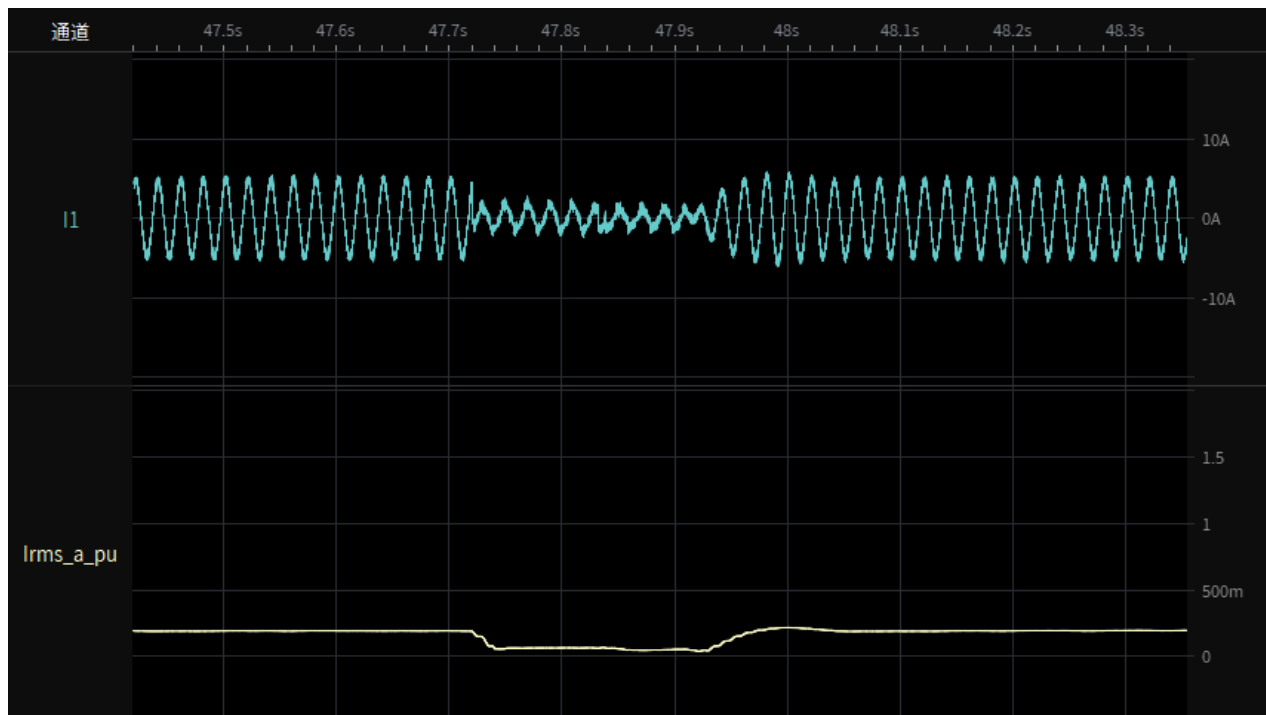

Test 8-1.4 Depth of fault phase: 1.25p.u.,three-phase-symmetrical (type A),20% load
restoring time

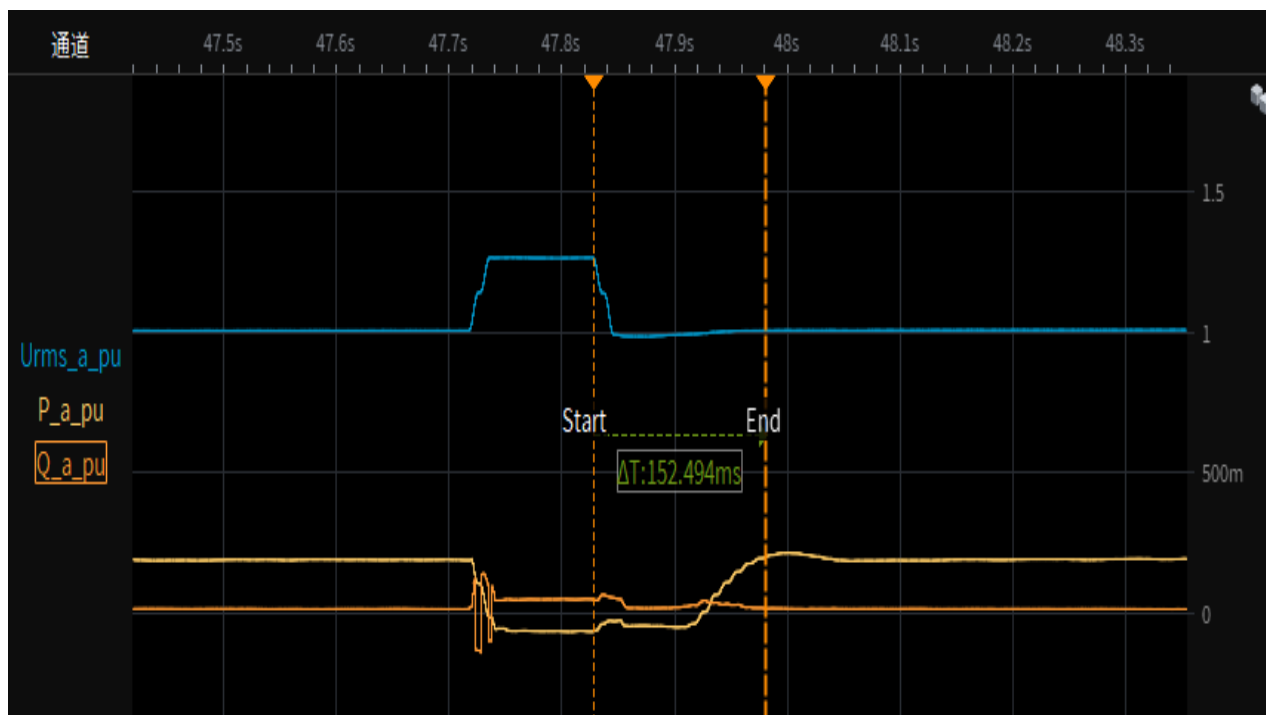

CEI 0-21			
Clause	Requirement - Test	Result - Remark	Verdict

Test 8-2.1 Depth of fault phase: 1.25p.u.,three-phase-symmetrical (type A),95% load
Test overview(voltage,current,active and reactive power)

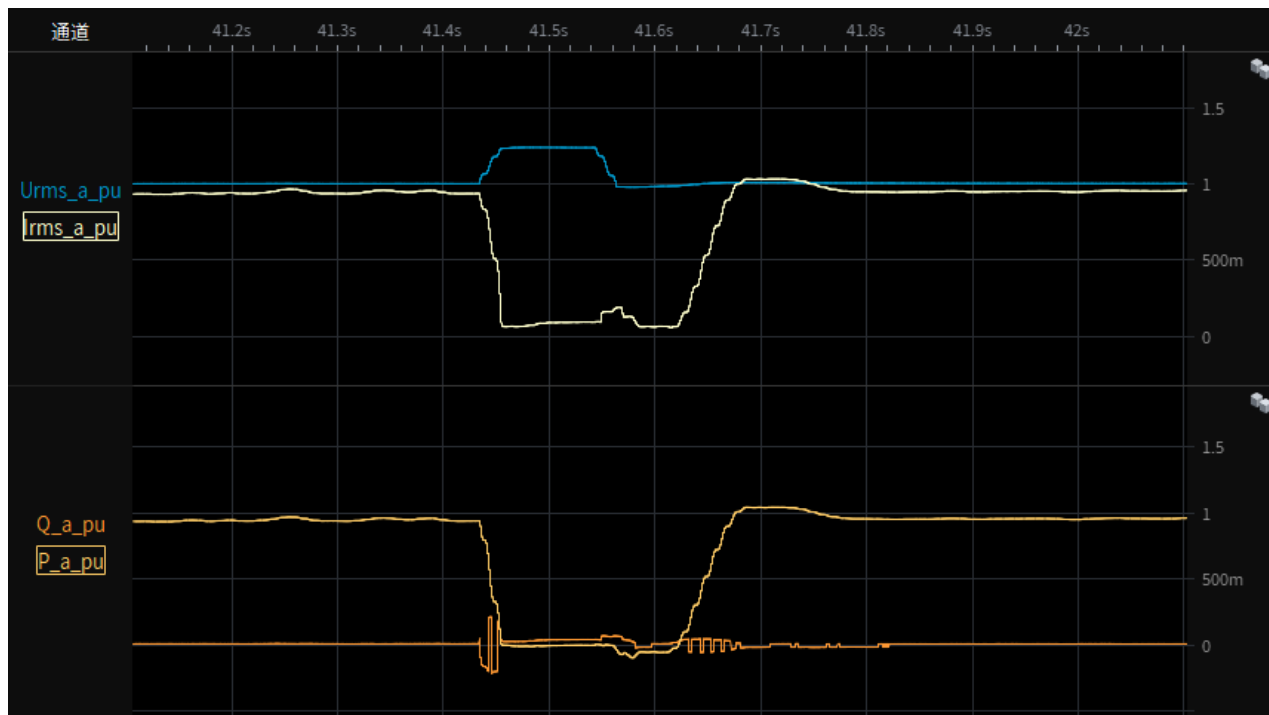

Test 8-2.2 Depth of fault phase: 1.25p.u.,three-phase-symmetrical (type A),95% load
Instantaneous curve and RMS value of phase-to-neutral voltages

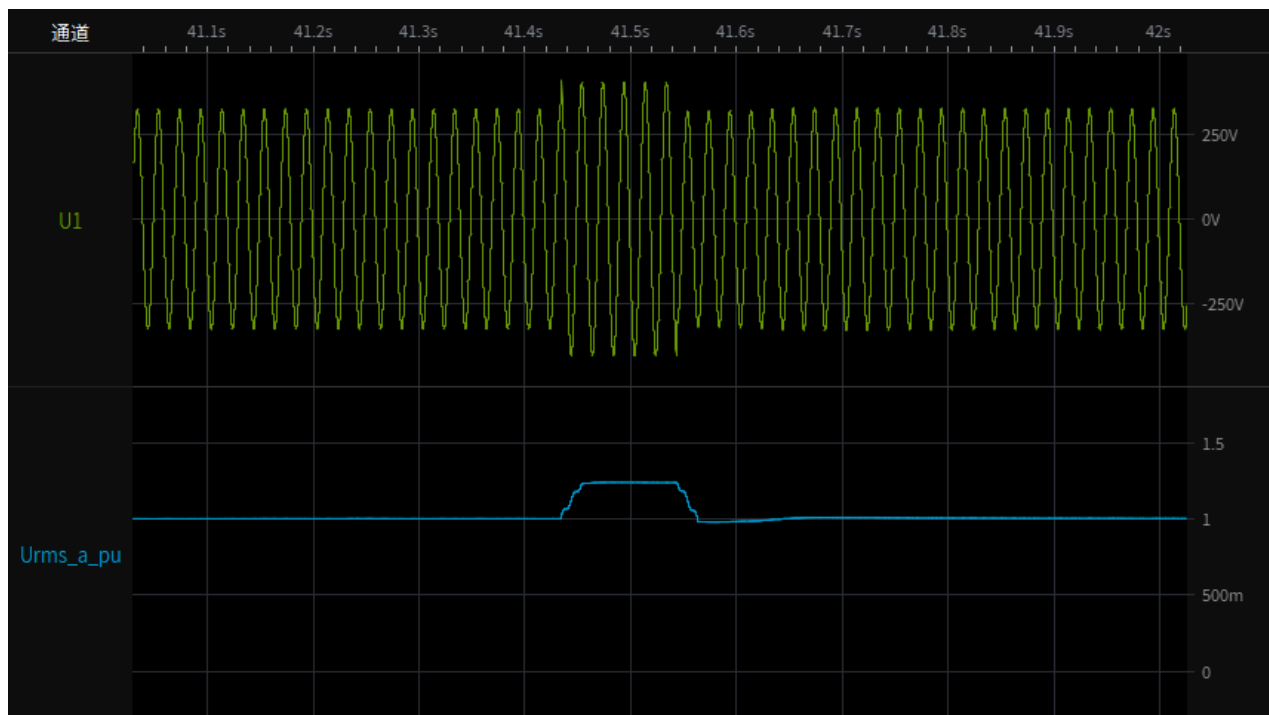

CEI 0-21			
Clause	Requirement - Test	Result - Remark	Verdict

Test 8-2.3 Depth of fault phase: 1.25p.u.,three-phase-symmetrical (type A),95% load
Instantaneous curve and RMS value of phase currents

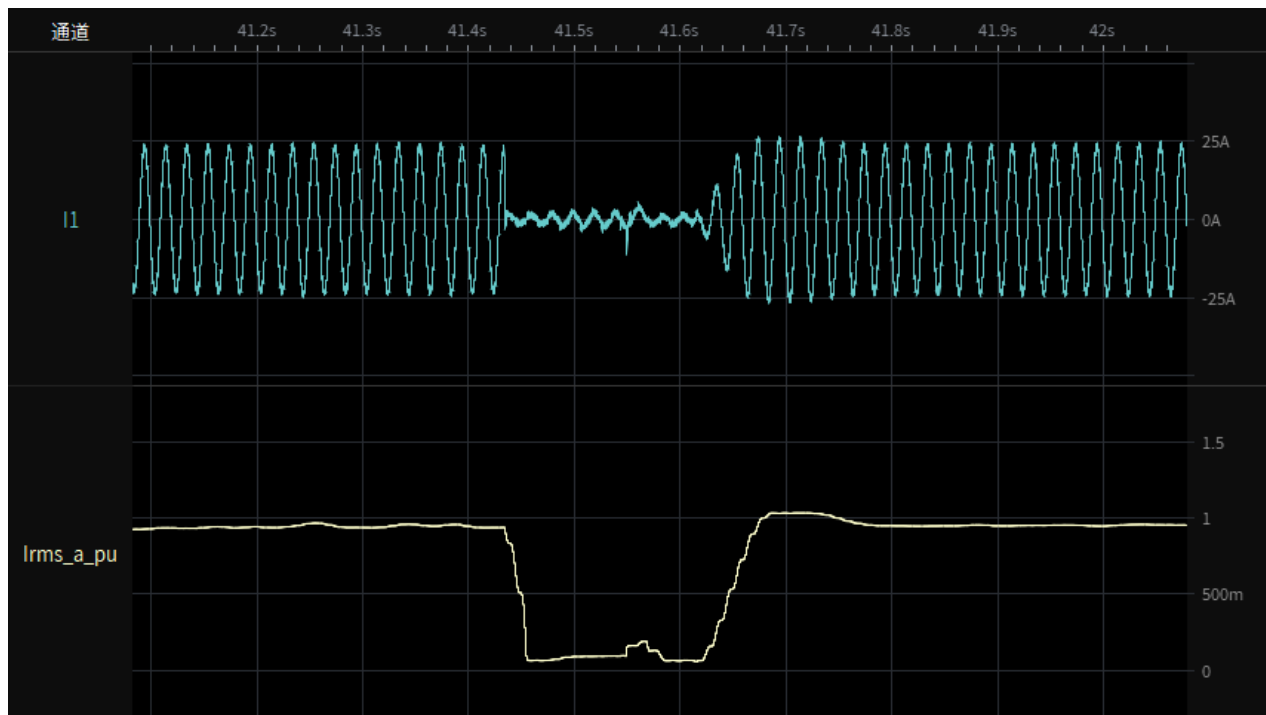

Test 8-2.4 Depth of fault phase: 1.25p.u.,three-phase-symmetrical (type A), 95% load
restoring time



CEI 0-21			
Clause	Requirement - Test	Result - Remark	Verdict

Bbis.10	TABLE: Verification of insensitivity to automatic reclosing in phase discrepancy					P
Model	VT-6607106+16Battery					
Test 1: Phase angle shift of 90°						
Power level	Cos ϕ	Phase shift angle(°)	Current 20 ms before phase shift(A)	Current 200ms after phase shift(A)	Result	
100%	0.9993	90	17.74	17.77	The PV inverter continue to feed power to grid after phase angle shift has been performed. No damage, no hazard.	
Test 2: Phase angle shift of 180°						
Power level	Cos ϕ	Phase shift angle(°)	Current 20 ms before phase shift(A)	Current 200ms after phase shift(A)	Result	
100%	0.9992	180	17.86	18.78	The PV inverter continue to feed power to grid after phase angle shift has been performed. No damage, no hazard.	
Note:						
With reference to the diagram shown in Figure 75 - use of simulated network:						
-the network simulator must be able to produce phase jumps in the voltage at the inverter output terminals of 90° and 180° respectively;						
-the storage system must operate at a power level compatible with the characteristics of the test circuit and with a unitary power factor ($\cos \phi = 1$);						
-VR: simulated mains voltage.						
-The storage system must be brought into operation at the full power available for discharge. Let the system operate in the set conditions for at least 5 minutes, compatibly with the energy capacity of the EESS, or the time required for the internal temperature of the converter to stabilize.						
At the end of the stabilization period, 2 tests must be carried out in sequence, inducing a transient that suddenly produces a phase shift angle on the simulated mains voltage VR equal to 90 ° and 180 °.						
In the test report, the following must be indicated for each of the two test sequences:						
-the angle between the voltage before and after the phase jump, with an instrument having an error of 1°;						
-the current of the storage system over a time window that runs from 20 ms before to at least 200 ms after the phase jump of the simulated mains voltage.						

CEI 0-21			
Clause	Requirement - Test	Result - Remark	Verdict



CEI 0-21			
Clause	Requirement - Test	Result - Remark	Verdict

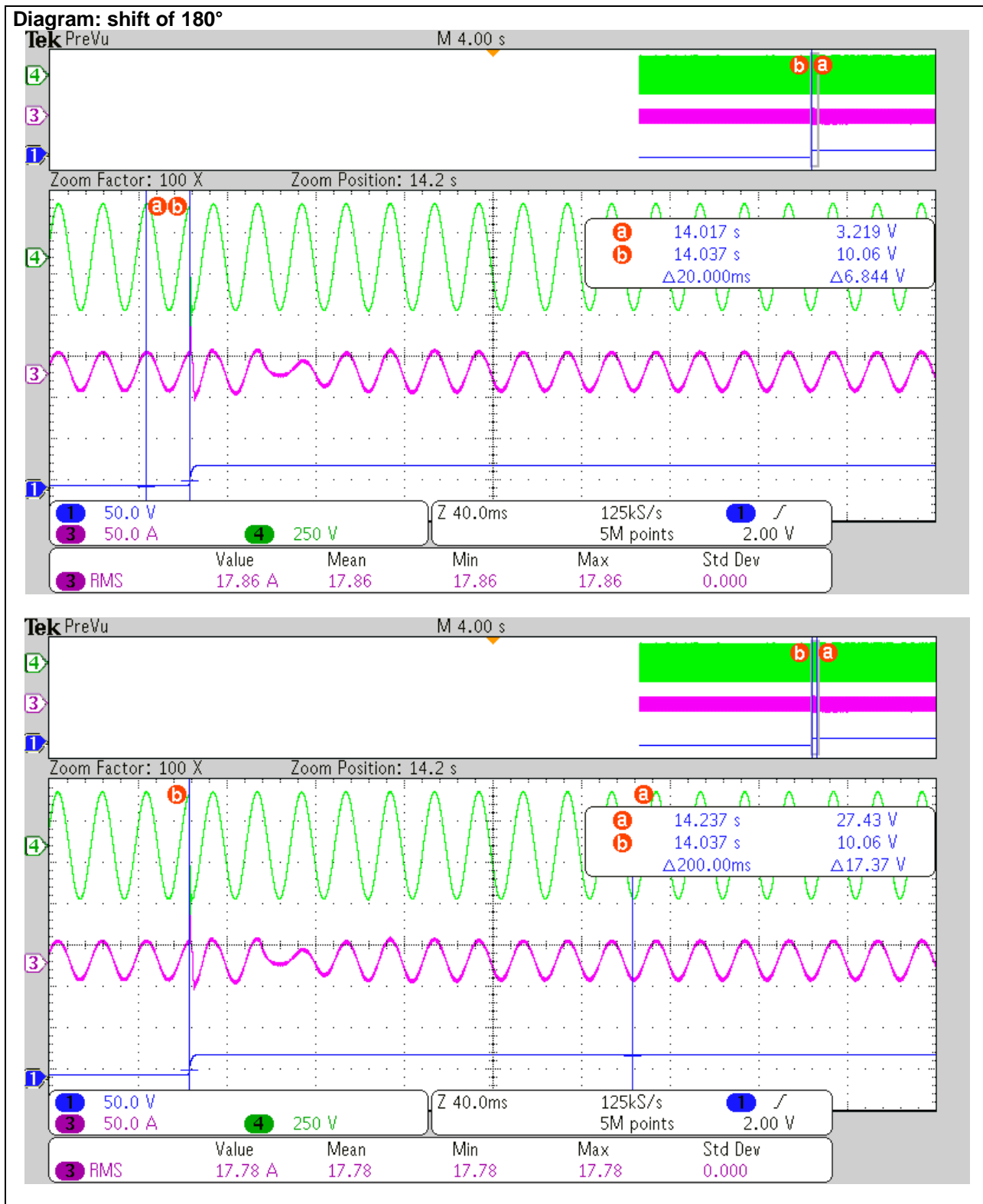

CEI 0-21			
Clause	Requirement - Test	Result - Remark	Verdict

Bbis.10	TABLE: Verification of insensitivity to automatic reclosing in phase discrepancy					P
Model	VT-6607106+1Battery					
Test 1: Phase angle shift of 90°						
Power level	Cos φ	Phase shift angle(°)	Current 20 ms before phase shift(A)	Current 200ms after phase shift(A)	Result	
100%	0.9976	90	17.81	17.82	The PV inverter continue to feed power to grid after phase angle shift has been performed. No damage, no hazard.	
Test 2: Phase angle shift of 180°						
Power level	Cos φ	Phase shift angle(°)	Current 20 ms before phase shift(A)	Current 200ms after phase shift(A)	Result	
100%	0.9977	180	17.71	17.87	The PV inverter continue to feed power to grid after phase angle shift has been performed. No damage, no hazard.	
Note:						
With reference to the diagram shown in Figure 75 - use of simulated network:						
-the network simulator must be able to produce phase jumps in the voltage at the inverter output terminals of 90° and 180° respectively;						
-the storage system must operate at a power level compatible with the characteristics of the test circuit and with a unitary power factor ($\cos \varphi = 1$);						
-VR: simulated mains voltage.						
-The storage system must be brought into operation at the full power available for discharge. Let the system operate in the set conditions for at least 5 minutes, compatibly with the energy capacity of the EESS, or the time required for the internal temperature of the converter to stabilize.						
At the end of the stabilization period, 2 tests must be carried out in sequence, inducing a transient that suddenly produces a phase shift angle on the simulated mains voltage VR equal to 90 ° and 180 °.						
In the test report, the following must be indicated for each of the two test sequences:						
-the angle between the voltage before and after the phase jump, with an instrument having an error of 1°;						
-the current of the storage system over a time window that runs from 20 ms before to at least 200 ms after the phase jump of the simulated mains voltage.						

CEI 0-21			
Clause	Requirement - Test	Result - Remark	Verdict

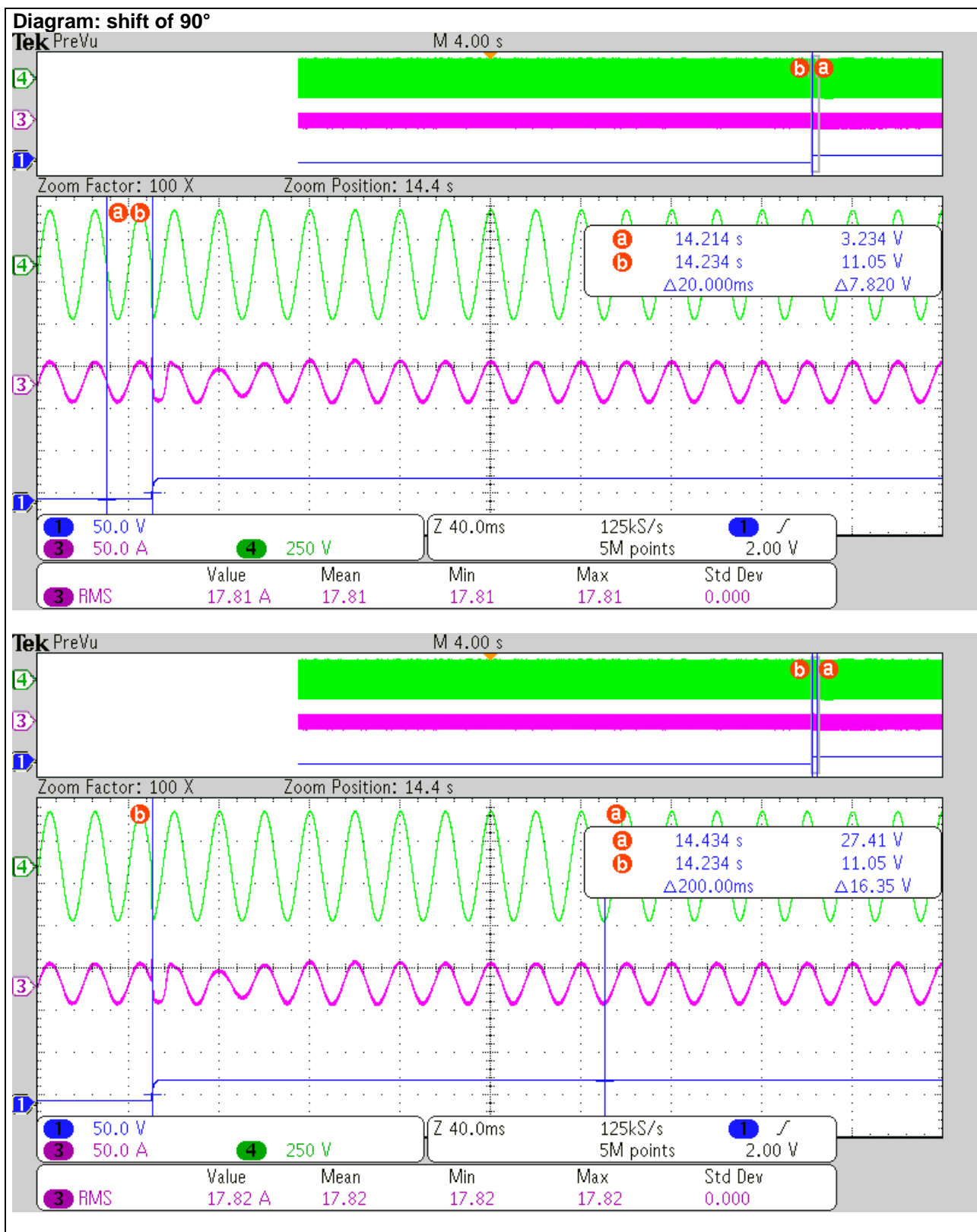

CEI 0-21			
Clause	Requirement - Test	Result - Remark	Verdict

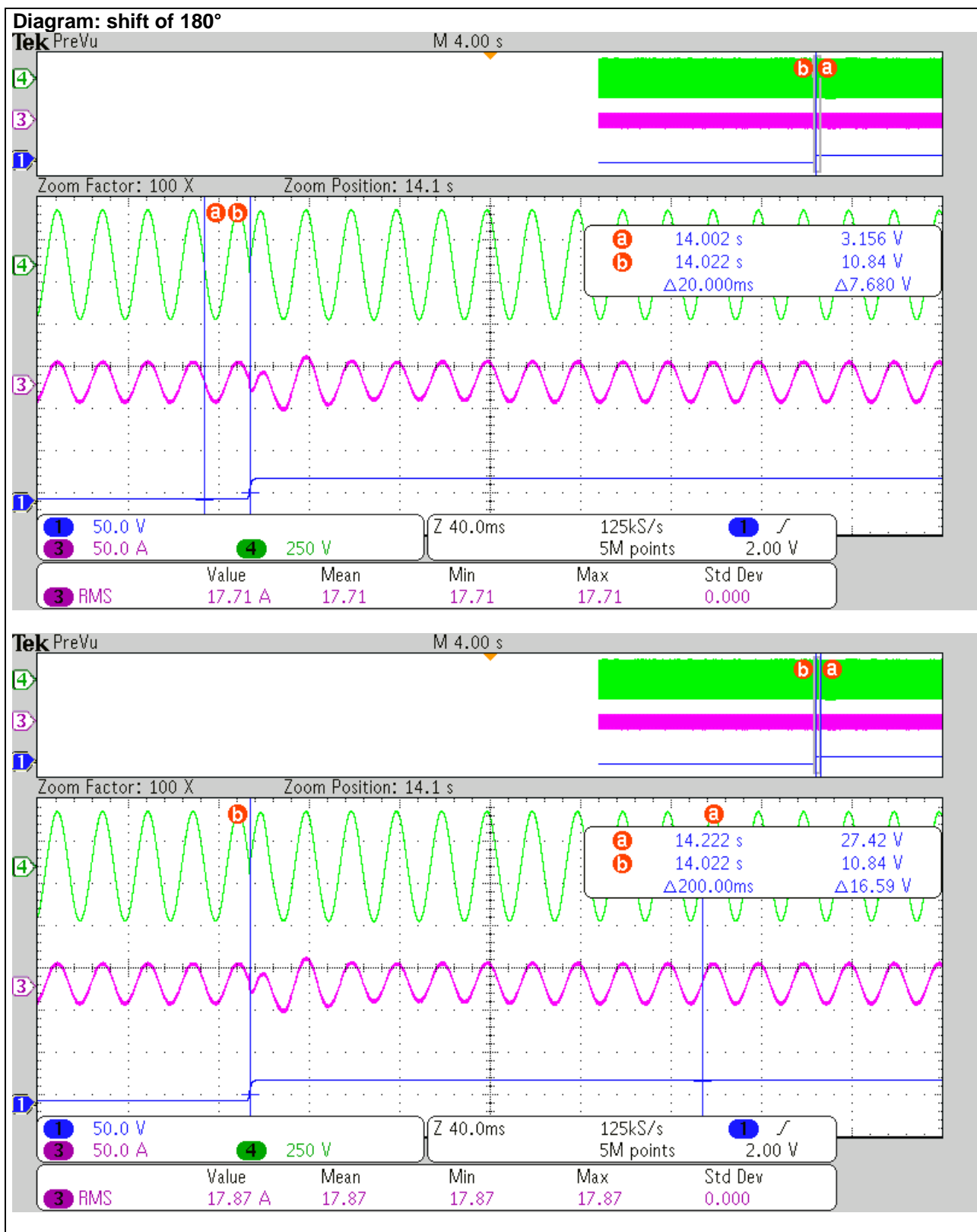

CEI 0-21			
Clause	Requirement - Test	Result - Remark	Verdict

Bbis.10	TABLE: Verification of insensitivity to automatic reclosing in phase discrepancy					P
Model	VT-6607100+1Battery					
Test 1: Phase angle shift of 90°						
Power level	Cos φ	Phase shift angle(°)	Current 20 ms before phase shift(A)	Current 200ms after phase shift(A)	Result	
100%	0.9972	90	4.431	4.381	The PV inverter continue to feed power to grid after phase angle shift has been performed. No damage, no hazard.	
Test 2: Phase angle shift of 180°						
Power level	Cos φ	Phase shift angle(°)	Current 20 ms before phase shift(A)	Current 200ms after phase shift(A)	Result	
100%	0.9974	180	4.383	4.346	The PV inverter continue to feed power to grid after phase angle shift has been performed. No damage, no hazard.	
Note:						
With reference to the diagram shown in Figure 75 - use of simulated network:						
-the network simulator must be able to produce phase jumps in the voltage at the inverter output terminals of 90° and 180° respectively;						
-the storage system must operate at a power level compatible with the characteristics of the test circuit and with a unitary power factor ($\cos \varphi = 1$);						
-VR: simulated mains voltage.						
-The storage system must be brought into operation at the full power available for discharge. Let the system operate in the set conditions for at least 5 minutes, compatibly with the energy capacity of the EESS, or the time required for the internal temperature of the converter to stabilize.						
At the end of the stabilization period, 2 tests must be carried out in sequence, inducing a transient that suddenly produces a phase shift angle on the simulated mains voltage VR equal to 90 ° and 180 °.						
In the test report, the following must be indicated for each of the two test sequences:						
-the angle between the voltage before and after the phase jump, with an instrument having an error of 1°;						
-the current of the storage system over a time window that runs from 20 ms before to at least 200 ms after the phase jump of the simulated mains voltage.						

CEI 0-21			
Clause	Requirement - Test	Result - Remark	Verdict



CEI 0-21			
Clause	Requirement - Test	Result - Remark	Verdict



Annex 1

ISO 9001 certificate



CERTIFICATE

N. CN23 – 12689A

This is to certify that the Quality Management System of

AFORE NEW ENERGY TECHNOLOGY (SHANGHAI) CO.,LTD.

Unified social credit code: 91310000561932991K

Registered Address

Building 7, No.333, Wanfang Road, Minhang District, Shanghai

Office & Production Address

Building 7, No.333, Wanfang Road, Minhang District, Shanghai, China

Has been independently assessed and found in conformance with the standard

ISO 9001:2015

For the following scope of activities:

R & D and Manufacture of Photovoltaic Inverter

IAF 19

For further and updated information regarding any changes in the status of this certification please contact via phone under +355696037861 / +39 0296368458 or via email to info@axe-register.com or verify directly on the website www.axe-register.com by using the organization name or the certificate number.

The validity of this certificate is subject to periodic yearly surveillance audit and triennial review of the entire management system of the certified organization.

Date of first registration	10/07/2017
Date of this certificate	07/07/2023
Date of expiry	09/07/2026



CS 007 26.02.18



On behalf of the Certification Body
AXE REGISTER Ltd
Antonio Llavida
Technical Director

Signatory of EA/MLA, Mutual Recognition Agreements

During validity period of the certificate a surveillance audit should be carried out once within each 12 months. The label should be pasted on specified position of right side of the certificate then it is valid. The certificate can be checked out at CNCA website (www.cnca.gov.cn).













AXE REGISTER

Piazza Unità d'Italia, 5 - 21047 Saronno (VA) - Italia | +39 02 96368458 | info@axe-register.com
ACM (CHINA) LIMITED, Rm B201, No 352, Waihuan Road, Minhang District, Shanghai 201199, China

Annex 2

IEC 62619 Certificate for used battery

	Ref. Certif. No. DE 7-0774										
IEC SYSTEM FOR MUTUAL RECOGNITION OF TEST CERTIFICATES FOR ELECTRICAL EQUIPMENT (IECEE) CB SCHEME											
<table style="width: 100%; border-collapse: collapse;"> <tr> <td colspan="2" style="padding-bottom: 10px;">CB TEST CERTIFICATE</td> </tr> <tr> <td style="width: 40%; vertical-align: top; padding: 5px;"> <p>Product</p> <p>Name and address of the applicant</p> <p>Name and address of the manufacturer</p> <p>Name and address of the factory</p> <p><i>Note: When more than one factory, please report on page 2</i></p> <p>Ratings and principal characteristics</p> <p>Trademark / Brand (if any)</p> <p>Customer's Testing Facility (CTF) Stage used</p> <p>Model / Type Ref.</p> <p>Additional information (if necessary may also be reported on page 2)</p> <p>A sample of the product was tested and found to be in conformity with</p> <p>As shown in the Test Report Ref. No. which forms part of this Certificate</p> </td> <td style="width: 60%; vertical-align: top; padding: 5px; background-color: #f0f0f0;"> <p>Secondary Lithium Battery</p> <p>Hangzhou Vestwoods Technology Co., LTD Floor 3, Building 1, Yongle Countryside, Cangqian Street Yuhang District, Hangzhou City, Zhejiang Province, 311121 China</p> <p>Hangzhou Vestwoods Technology Co., LTD Floor 3, Building 1, Yongle Countryside, Cangqian Street Yuhang District, Hangzhou City, Zhejiang Province, 311121 China</p> <p>Nantong Weimuruopu Technology Co., Ltd. No.8, Jiangjiawei Road, Yongxing Street, Chongchuan District Nantong City, Jiangsu Province China <input type="checkbox"/> Additional information on page 2</p> <p>a1), a2), a3): 48V, 100Ah, 4800Wh b1), b2), b3), c), d): 51.2V, 100Ah, 5120Wh</p> <div style="text-align: center; margin: 10px 0;">  </div> <p>a1) VT48100E-A1; a2) VT48100E-P1; a3) VE48100E-P1; b1) VT48100E-A2; b2) VT48100E-P2; b3) VE48100E-P2; c) VT48100E-W; d) VE48100E</p> <p><input type="checkbox"/> Additional information on page 2</p> <p>IEC 62619:2022</p> <p>BL-DG2351056-301</p> </td> </tr> <tr> <td colspan="2" style="padding: 10px;"> <p style="text-align: center;">This CB Test Certificate is issued by the National Certification Body</p> <table style="width: 100%; border-collapse: collapse;"> <tr> <td style="width: 50%; padding: 5px;"> TÜV NORD CERT GmbH Am TÜV 1 Essen, 45307 Germany </td> <td style="width: 50%; text-align: center; padding: 5px;">  TÜVNORD </td> </tr> <tr> <td style="padding: 5px;"> Date: 2023-06-29 </td> <td style="padding: 5px;"> Signature: Matthias Böttcher </td> </tr> </table> </td> </tr> </table>		CB TEST CERTIFICATE		<p>Product</p> <p>Name and address of the applicant</p> <p>Name and address of the manufacturer</p> <p>Name and address of the factory</p> <p><i>Note: When more than one factory, please report on page 2</i></p> <p>Ratings and principal characteristics</p> <p>Trademark / Brand (if any)</p> <p>Customer's Testing Facility (CTF) Stage used</p> <p>Model / Type Ref.</p> <p>Additional information (if necessary may also be reported on page 2)</p> <p>A sample of the product was tested and found to be in conformity with</p> <p>As shown in the Test Report Ref. No. which forms part of this Certificate</p>	<p>Secondary Lithium Battery</p> <p>Hangzhou Vestwoods Technology Co., LTD Floor 3, Building 1, Yongle Countryside, Cangqian Street Yuhang District, Hangzhou City, Zhejiang Province, 311121 China</p> <p>Hangzhou Vestwoods Technology Co., LTD Floor 3, Building 1, Yongle Countryside, Cangqian Street Yuhang District, Hangzhou City, Zhejiang Province, 311121 China</p> <p>Nantong Weimuruopu Technology Co., Ltd. No.8, Jiangjiawei Road, Yongxing Street, Chongchuan District Nantong City, Jiangsu Province China <input type="checkbox"/> Additional information on page 2</p> <p>a1), a2), a3): 48V, 100Ah, 4800Wh b1), b2), b3), c), d): 51.2V, 100Ah, 5120Wh</p> <div style="text-align: center; margin: 10px 0;">  </div> <p>a1) VT48100E-A1; a2) VT48100E-P1; a3) VE48100E-P1; b1) VT48100E-A2; b2) VT48100E-P2; b3) VE48100E-P2; c) VT48100E-W; d) VE48100E</p> <p><input type="checkbox"/> Additional information on page 2</p> <p>IEC 62619:2022</p> <p>BL-DG2351056-301</p>	<p style="text-align: center;">This CB Test Certificate is issued by the National Certification Body</p> <table style="width: 100%; border-collapse: collapse;"> <tr> <td style="width: 50%; padding: 5px;"> TÜV NORD CERT GmbH Am TÜV 1 Essen, 45307 Germany </td> <td style="width: 50%; text-align: center; padding: 5px;">  TÜVNORD </td> </tr> <tr> <td style="padding: 5px;"> Date: 2023-06-29 </td> <td style="padding: 5px;"> Signature: Matthias Böttcher </td> </tr> </table>		TÜV NORD CERT GmbH Am TÜV 1 Essen, 45307 Germany	 TÜVNORD	Date: 2023-06-29	Signature: Matthias Böttcher
CB TEST CERTIFICATE											
<p>Product</p> <p>Name and address of the applicant</p> <p>Name and address of the manufacturer</p> <p>Name and address of the factory</p> <p><i>Note: When more than one factory, please report on page 2</i></p> <p>Ratings and principal characteristics</p> <p>Trademark / Brand (if any)</p> <p>Customer's Testing Facility (CTF) Stage used</p> <p>Model / Type Ref.</p> <p>Additional information (if necessary may also be reported on page 2)</p> <p>A sample of the product was tested and found to be in conformity with</p> <p>As shown in the Test Report Ref. No. which forms part of this Certificate</p>	<p>Secondary Lithium Battery</p> <p>Hangzhou Vestwoods Technology Co., LTD Floor 3, Building 1, Yongle Countryside, Cangqian Street Yuhang District, Hangzhou City, Zhejiang Province, 311121 China</p> <p>Hangzhou Vestwoods Technology Co., LTD Floor 3, Building 1, Yongle Countryside, Cangqian Street Yuhang District, Hangzhou City, Zhejiang Province, 311121 China</p> <p>Nantong Weimuruopu Technology Co., Ltd. No.8, Jiangjiawei Road, Yongxing Street, Chongchuan District Nantong City, Jiangsu Province China <input type="checkbox"/> Additional information on page 2</p> <p>a1), a2), a3): 48V, 100Ah, 4800Wh b1), b2), b3), c), d): 51.2V, 100Ah, 5120Wh</p> <div style="text-align: center; margin: 10px 0;">  </div> <p>a1) VT48100E-A1; a2) VT48100E-P1; a3) VE48100E-P1; b1) VT48100E-A2; b2) VT48100E-P2; b3) VE48100E-P2; c) VT48100E-W; d) VE48100E</p> <p><input type="checkbox"/> Additional information on page 2</p> <p>IEC 62619:2022</p> <p>BL-DG2351056-301</p>										
<p style="text-align: center;">This CB Test Certificate is issued by the National Certification Body</p> <table style="width: 100%; border-collapse: collapse;"> <tr> <td style="width: 50%; padding: 5px;"> TÜV NORD CERT GmbH Am TÜV 1 Essen, 45307 Germany </td> <td style="width: 50%; text-align: center; padding: 5px;">  TÜVNORD </td> </tr> <tr> <td style="padding: 5px;"> Date: 2023-06-29 </td> <td style="padding: 5px;"> Signature: Matthias Böttcher </td> </tr> </table>		TÜV NORD CERT GmbH Am TÜV 1 Essen, 45307 Germany	 TÜVNORD	Date: 2023-06-29	Signature: Matthias Böttcher						
TÜV NORD CERT GmbH Am TÜV 1 Essen, 45307 Germany	 TÜVNORD										
Date: 2023-06-29	Signature: Matthias Böttcher										

IEC 62619 Certificate for used battery

	Ref. Certif. No. JPTUV-148854
---	---

IEC SYSTEM FOR MUTUAL RECOGNITION OF TEST CERTIFICATES FOR ELECTRICAL EQUIPMENT (IECEE) CB SCHEME

CB TEST CERTIFICATE

Product	Secondary Lithium Battery
Name and address of the applicant	Hangzhou Vestwoods Technology Co., LTD Floor 3, Building 1, Yongle Countryside, Cangqian Street,, Yuhang District, Hangzhou City, 311121 Zhejiang Province, P.R. China
Name and address of the manufacturer	Hangzhou Vestwoods Technology Co., LTD Floor 3, Building 1, Yongle Countryside, Cangqian Street,, Yuhang District, Hangzhou City, 311121 Zhejiang Province, P.R. China
Name and address of the factory	Nantong Weimuruo Technology Co., Ltd. No.8, Jiangjiawei Road, Yongxing Street, Chongchuan District, Nantong City, Jiangsu, P.R. China
Ratings and principal characteristics	51.2V;100Ah
Trademark (if any)	VESTWOODS (logo)
Customer's Testing Facility (CTF) Stage used	N/A
Model / Type Ref.	VE51100RS
Additional information (if necessary may also be reported on page 2)	Detail information refer to test report CN23JYW7 001
A sample of the product was tested and found to be in conformity with	IEC 62619:2022 See Test Report for National Differences
As shown in the Test Report Ref. No. which forms part of this Certificate	CN23JYW7 001

This CB Test Certificate is issued by the National Certification Body

	TÜV Rheinland Japan Ltd. Global Technology Assessment Center 4-25-2 Kita-Yamata, Tsuzuki-ku Yokohama 224-0021, Japan Phone + 81 45 914-3888 Fax + 81 45 914-3354 Mail: info@jpn.tuv.com Web : www.tuv.com	 Weichun Li
Date: 2023-06-06	Signature:	

10001 CB 00204/K

Disclaimer: This is an electronically released document. The authenticity of this certificate can be verified on the IECEE Website "http://certificates.iecee.org"

IEC 62619 Certificate for used battery

	Ref. Certif. No. JPTUV-145410
---	---

IEC SYSTEM FOR MUTUAL RECOGNITION OF TEST CERTIFICATES FOR ELECTRICAL EQUIPMENT (IECEE) CB SCHEME

CB TEST CERTIFICATE

Product	Rechargeable Li-ion Battery
Name and address of the applicant	Hangzhou Vestwoods Technology Co., LTD Floor 3, Building 1, Yongle Countryside, Cangqian Street, Yuhang District, Hangzhou City, 311121 Zhejiang Province, P.R. China
Name and address of the manufacturer	Hangzhou Vestwoods Technology Co., LTD Floor 3, Building 1, Yongle Countryside, Cangqian Street, Yuhang District, Hangzhou City, 311121 Zhejiang Province, P.R. China
Name and address of the factory	Nantong Weimuruopu Technology Co., Ltd. No.8, Jiangjiawei Road, Yongxing Street, Chongchuan District, Nantong City, Jiangsu, P.R. China
Ratings and principal characteristics	51.2 Vd.c., 100 Ah
Trademark (if any)	VESTWOODS (logo)
Customer's Testing Facility (CTF) Stage used	N/A
Model / Type Ref.	VE51100W
Additional information (if necessary may also be reported on page 2)	
A sample of the product was tested and found to be in conformity with	IEC 62619:2022 See Test Report for National Differences
As shown in the Test Report Ref. No. which forms part of this Certificate	CN23QZWT 001

This CB Test Certificate is issued by the National Certification Body

 TÜVRheinland®	TÜV Rheinland Japan Ltd. Global Technology Assessment Center 4-25-2 Kita-Yamata, Tsuzuki-ku Yokohama 224-0021, Japan Phone + 81 45 914-3888 Fax + 81 45 914-3354 Mail: info@jpn.tuv.com Web : www.tuv.com	 A. Chen
Date: 2023-03-15	Signature:	

10001 CB 02/2016/ik

Disclaimer: This is an electronically released document. The authenticity of this certificate can be verified on the IECEE Website "http://certificates.iecee.org"

Annex 3

Datasheet of the relay

HF161F-W SOLAR RELAY



File No.:E134517



File No.:40031410

File No.:CQC10002050943
CQC18002203499

Features

- 31A switching capacity
- Applicable to inverter used for photovoltaic power generation systems
- Ideal for UPS
- 1.5mm contact gap (compliant to European Photovoltaic Standard VDE0126)
- 1.8mm contact gap (compliant to IEC 62109-2-2011)
- The clearance distance between contact and coil is bigger than 6.4mm, the creepage distance is bigger than 8mm. (special code 477: **7.5mm**)
- Low coil holding voltage contributes to saving energy of equipment.
- UL insulation system: Class F

RoHS compliant

CONTACT DATA

Contact gap	1.5mm	1.8mm	2.0mm	2.3mm
Contact arrangement	1A			
Contact resistance ¹⁾	≤100mΩ (1A 6VDC)			
Contact material	AgSnO ₂			
Contact rating	Resistive: 26A 250VAC Inductive: 31A 250VAC (cosφ=0.8) 0.1s:10s	Resistive: 26A 250VAC Inductive: 33A 250VAC (cosφ=0.8) 0.1s:10s	Resistive: 26A 250VAC Inductive: 31A 250VAC (cosφ=0.8) 0.1s:10s	Resistive: 26A 250VAC
Max. switching voltage	277VAC			
Max. switching current	31A	33A	31A	26A
Max. switching power	7750VA	8250VA	7750VA	7202VA
Mechanical endurance	1 x 10 ⁶ OPS	1 x 10 ⁵ OPS	1 x 10 ⁵ OPS	1 x 10 ⁵ OPS
Electrical endurance	HT type: 3 x 10 ⁷ OPS (26A 250VAC Resistive) 75°C 1.5s on 1.5s off)	HT type: 3 x 10 ⁷ OPS (26A 250VAC Resistive) 75°C 1.5s on 1.5s off)	HT type: 3 x 10 ⁷ OPS (26A 250VAC Resistive) 75°C 1.5s on 1.5s off)	HT type: 3 x 10 ⁷ OPS (26A 250VAC Resistive) Room temp. 1.5s on 1.5s off)

Notes: 1)The data shown above are initial values.

COIL

Coil power	Approx. 1.4W
Holding voltage	35% to 120%U _N (at 23°C) 45% to 80%U _N (at 85°C)

Notes: 1)The coil holding voltage is the voltage of coil after being applied rated voltage for 100ms

2)The relay coil does not allow applied more than maximum of holding voltage values for a long time (Eg: 120% U_N at 23°C; 80% U_N at 85°C), prevent overheating burned.

COIL DATA

at 23°C

Nominal Voltage VDC	Pick-up Voltage VDC max. ¹⁾	Drop-out Voltage VDC min. ¹⁾	Max. Voltage VDC *2)	Coil Resistance Ω
9	6.3	0.9	10.8	58 x (1±10%)
12	8.4	1.2	14.4	103 x (1±10%)
18	12.6	1.8	21.6	230 x (1±10%)
24	16.8	2.4	28.8	410 x (1±10%)

Notes: 1)The data shown above are initial values.

2)*Maximum voltage refers to the maximum voltage which relay coil could endure in a short period of time.



HONGFA RELAY

ISO9001、ISO/TS16949、ISO14001、OHSAS18001、IECQ QC 080000 CERTIFIED

2019 Rev. 1.00

CHARACTERISTICS

Insulation resistance	1000MΩ (at 500VDC)	
Dielectric strength	Between coil & contacts	4500VAC 1min
	Between open contacts	2500VAC 1min
Surge voltage (between coil & contacts)	10kV (1.2/50μs)	
Operate time (at rated. volt.)	20ms max.	
Release time (at rated. volt.)	10ms max.	
Temperature rise (at rated. volt.)	95K max. (Contact load current 31A, rated voltage excitation, at 60°C)	
	70K max. (Contact load current 31A, 80% of rated voltage excitation, at 85°C)	
Shock resistance	Functional	196m/s ²
	Destructive	980m/s ²
Vibration resistance	10Hz to 55Hz 1.5mm DA	
Ambient temperature	-40°C to 85°C (Apply holding voltage to coil, which is 45% to 80% that of rated voltage)	
Humidity	5% to 85% RH	
Termination	PCB	
Unit weight	Approx. 21g	
Construction	Flux proofed	

Notes: The data shown above are initial values.

SAFETY APPROVAL RATINGS

UL/CUL	AgSnO ₂	26A 277VAC at 75°C
		22A 277VAC at 85°C
VDE	AgSnO ₂	26A 277VAC at 75°C
		22A 277VAC at 85°C
		31A 250VAC cosφ=0.8 0.1s:10s 33A 250VAC cosφ=0.8 0.1s:10s (477)

Notes: 1) All values unspecified are at room temperature.

2) Only typical loads are listed above. Other load specifications can be available upon request.

ORDERING INFORMATION	
Type	HF161F-W / 12 -H T (XXX)
Coil voltage	9, 12, 18, 24VDC
Contact arrangement	H: 1 Form A
Contact material	T: AgSnO ₂
Special code ³⁾	XXX: Customer special requirement Nil: Standard

Notes: 1) Water cleaning or surface process is not suggested after the flux-proofed relays are assembled on PCB.
 2) Flux-proofed relays can not be used in the environment with pollutants like H₂S, SO₂, NO₂, dust, etc.
 3) The customer special requirement express as special code after evaluating by Hongfa. e.g. (414) stands for product with coil terminal of 1.4X0.4; e.g. (477) stands for Contact gap: 1.8mm.(456) stands for Contact gap: 2.0mm.(704)stands for Contact gap: 2.3mm.

OUTLINE DIMENSIONS, WIRING DIAGRAM AND PC BOARD LAYOUT Unit: mm

Outline Dimensions

Standard type

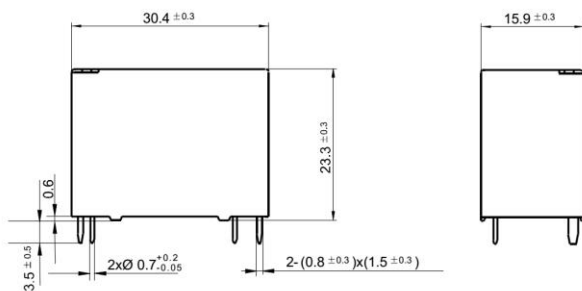

(414) special code version

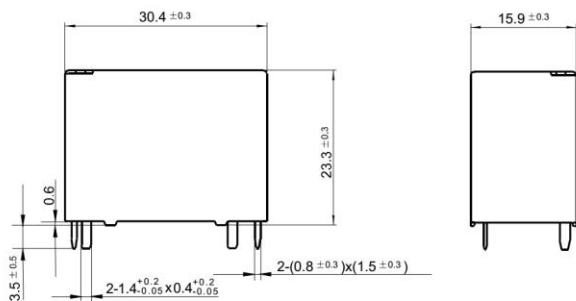

Annex 4

**Pictures of the unit
Enclosure – Front View**



Enclosure – Rear View

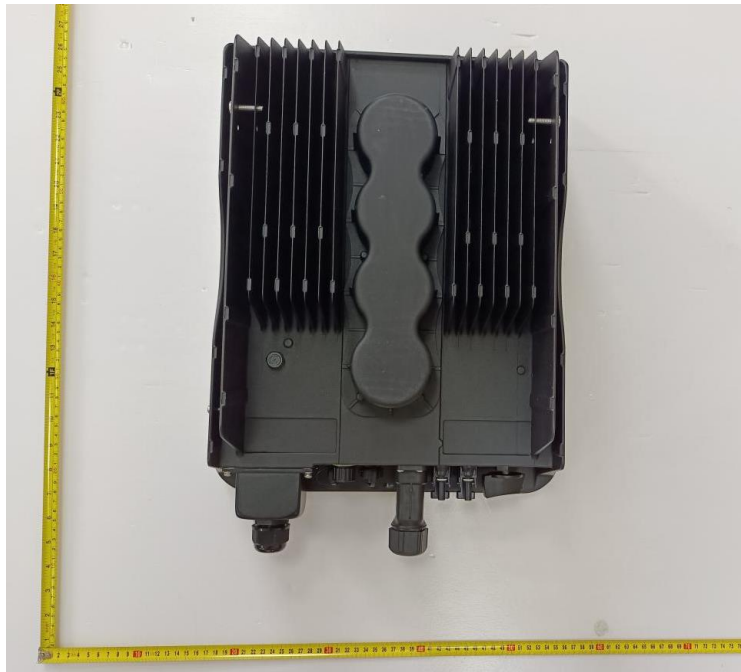

Enclosure – Side view (Right)



Enclosure – Side view (Left)



Enclosure –Bottom Side View for VT-6607106



Enclosure –Bottom Side View for VT-6607106-0



Enclosure – Side view (top)



Internal view of inverter



Internal view of inverter



Enclosure (Internal view)



Main board – Component Side



Main board – Soldering Side

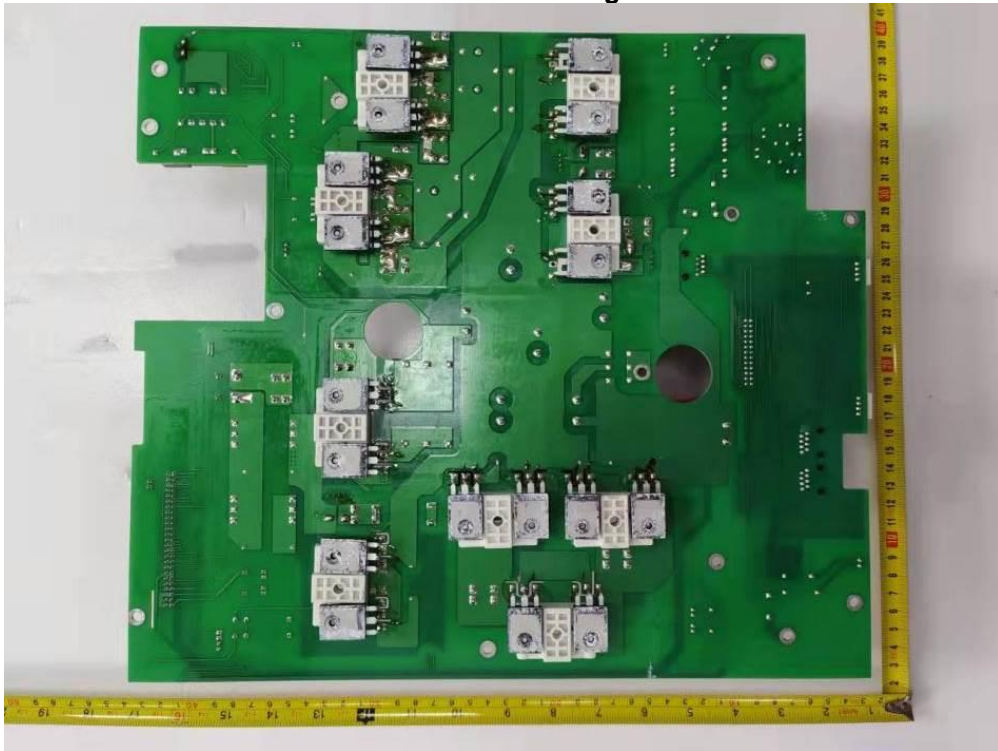

Filter board – Component Side

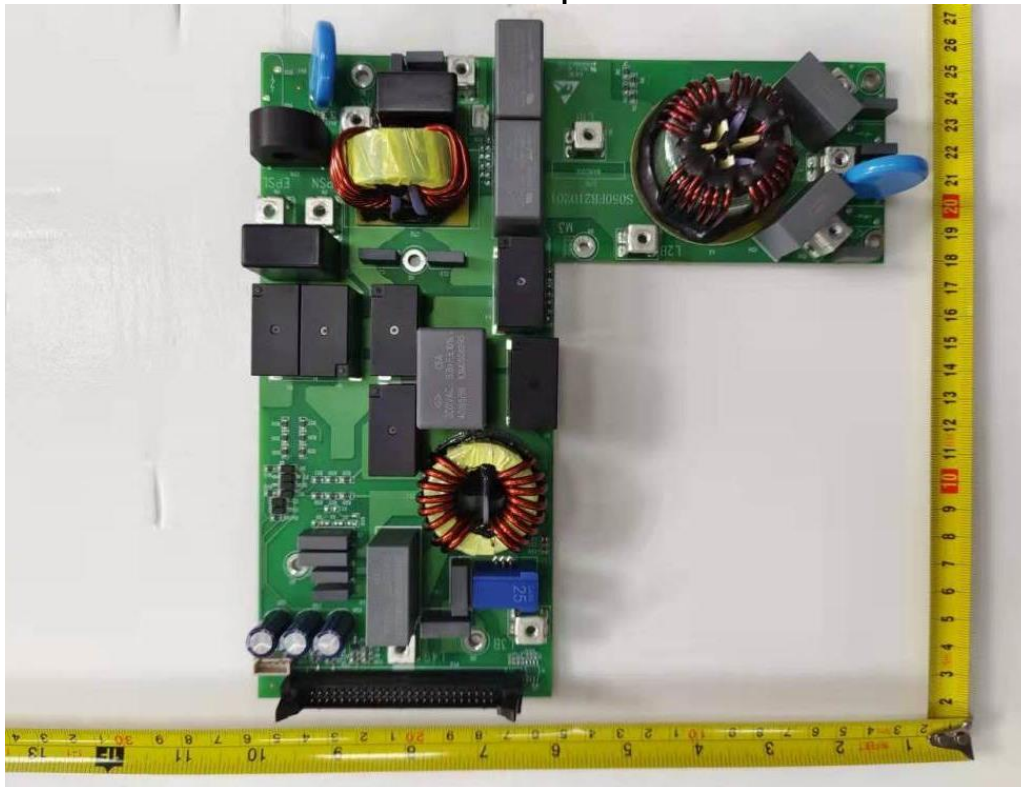

Filter board – Soldering Side

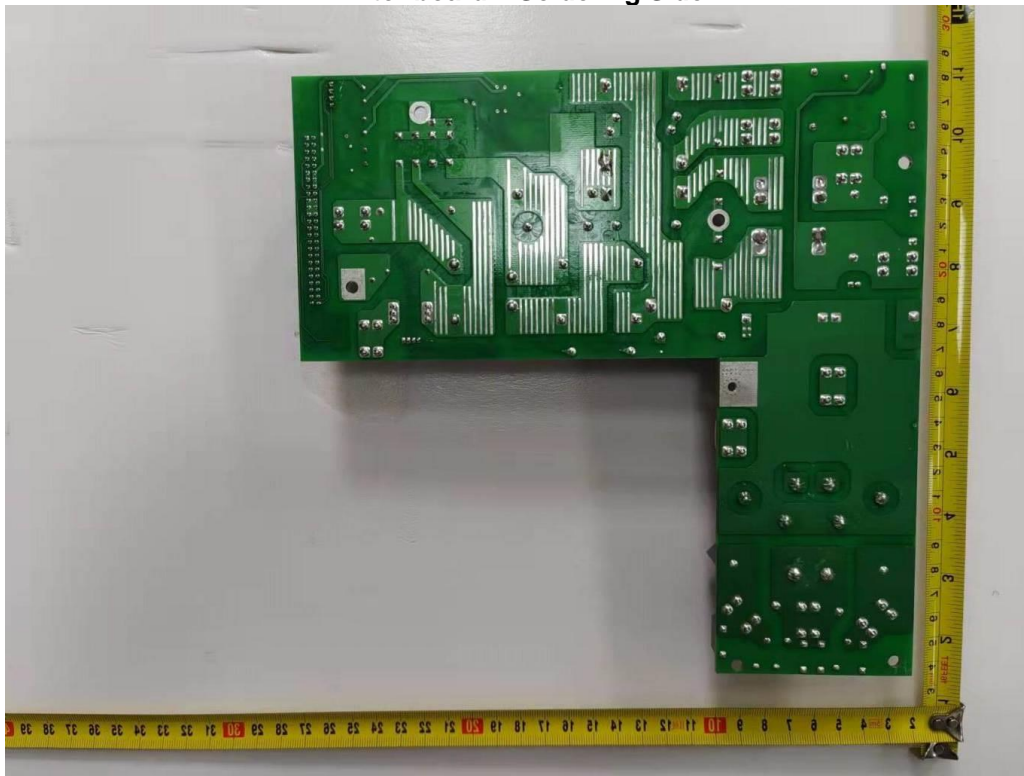

Control board – Component Side

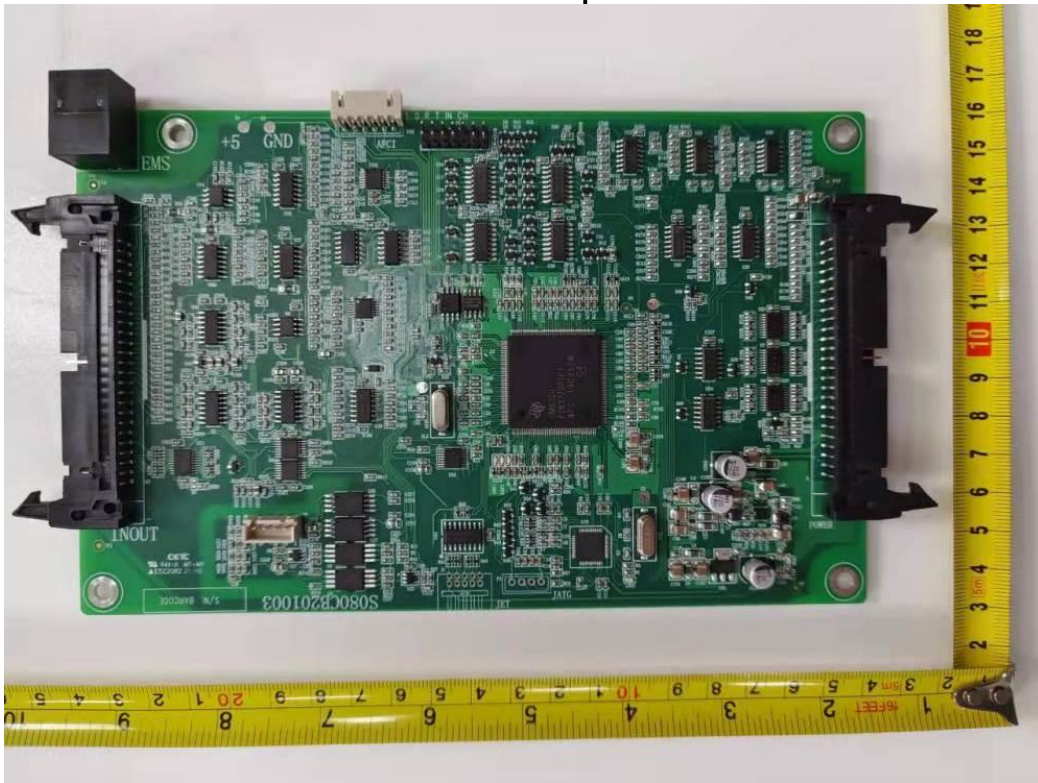

Control board – Soldering Side

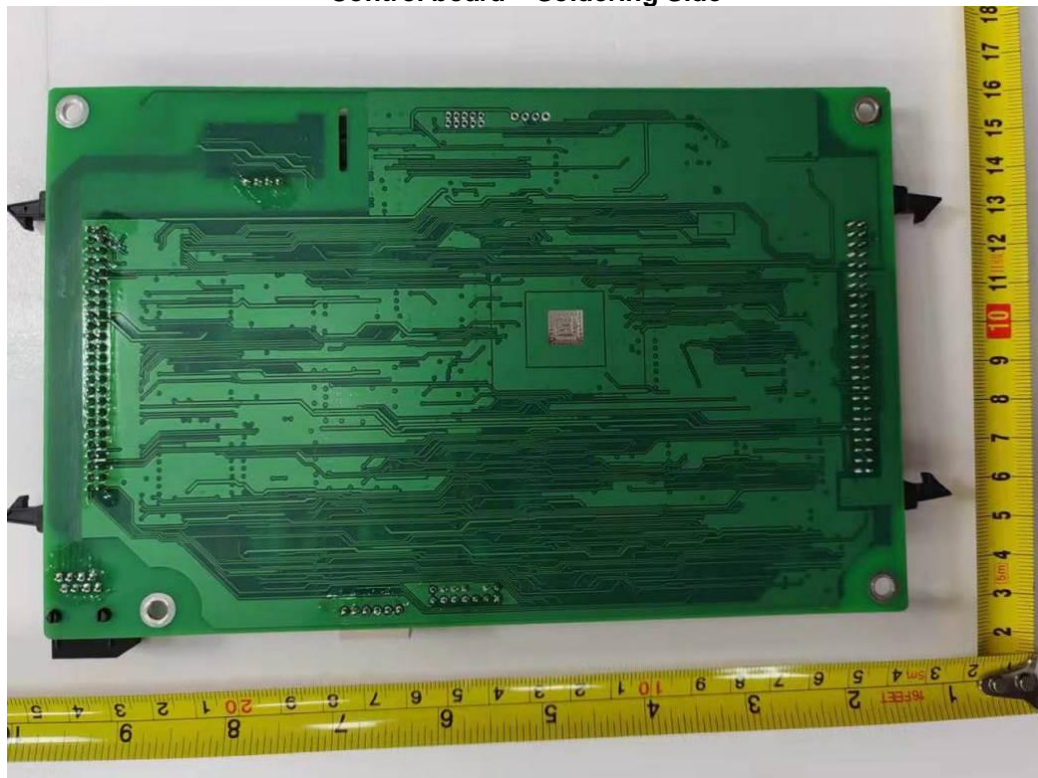

LCD Display board - Component Side

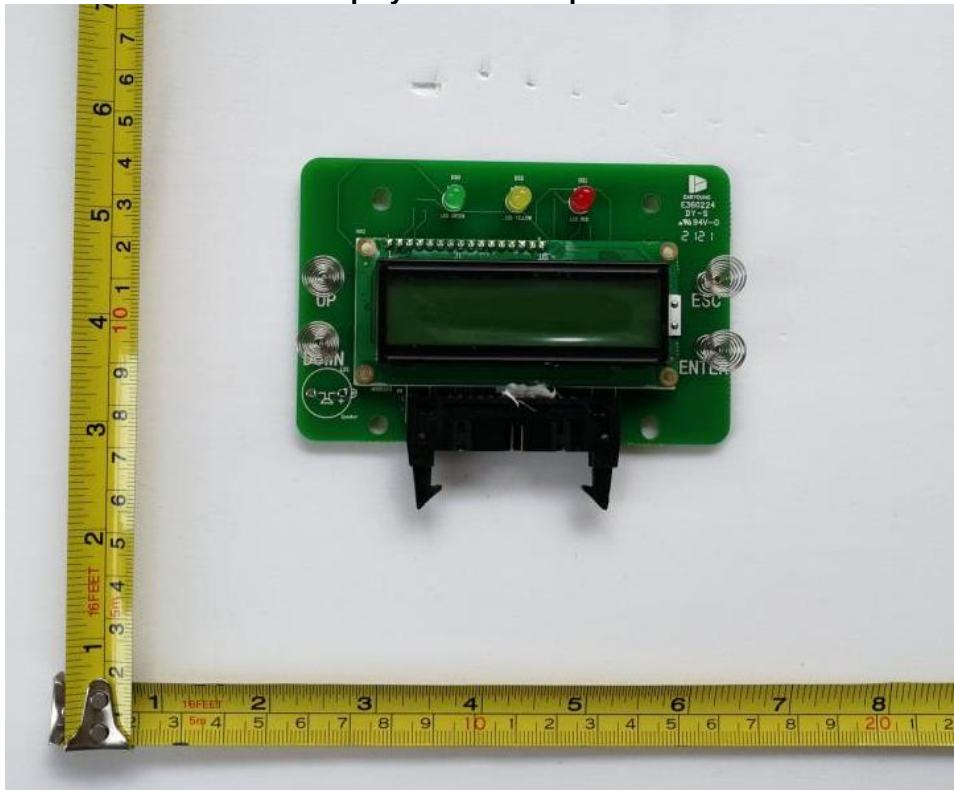

LCD Display board - Solder Side

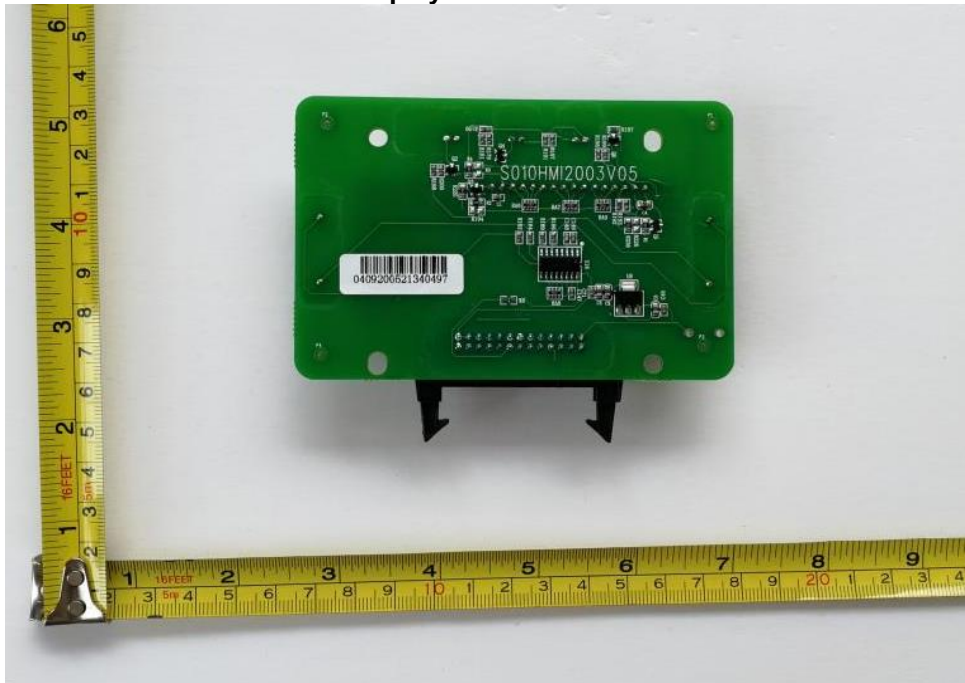

--- End of test report---