



Meaningful Innovation.

WEEE Number: 80133970

INSTRUCTION MANUAL

HYBRID SOLAR INVERTER SINGLE PHASE



INTRODUCTION

Thank you for selecting and buying V-TAC Product. V-TAC will serve you the best. Please read these instructions carefully & keep this user manual handy for future reference. If you have any another query, please contact our dealer or local vendor from whom you have purchased the product. They are trained and ready to serve you at the best.

WARNING

1. Please make sure to turn off the power before starting the installation.
2. Installation must be performed by a qualified electrician.



- "Danger" indicates a hazardous situation which, if not avoided, will result in death or serious injury.
- "Warning" indicates a hazardous situation which, if not avoided, could result in death or serious injury.
- "Caution" indicates a hazardous situation which, if not avoided, could result in minor or moderate injury..
- Danger to life due to high voltages in the inverter!
- All work must be carried out by qualified electrician.
- The appliance is not to be used by children or persons with reduced physical sensory or mental capabilities, or lack of experience and knowledge, unless they have been given supervision or instruction.
- Children should be supervised to ensure that they do not play with the appliance.
- Danger of burn injuries due to hot enclosure parts!
- During operation, the upper lid of the enclosure and the enclosure body may become hot.
- Only touch the lower enclosure lid during operation.
- Possible damage to health as a result of the effects of radiation!
- Do not stay closer than 20 cm to inverter for any length of time.
- Ensure input DC voltage \leq Max. DC voltage .Over voltage may cause permanent damage to inverter or other losses, which will not be included in warranty!
- Authorized service personnel must disconnect both AC and DC power from inverter before attempting any maintenance or cleaning or working on any circuits connected to inverter.
- Do not operate the in verter when the device is running
- Over-voltage protection with surge arresters should be provided when the PV power system is installed.
- The grid connected inverter is not fitted with SPDs in both PV input side and MAINS side.
- High leakage current! Earth connection essential before connecting supply.

Note!



- "Note" provides tips that are valuable for the optimal operation of our product.
 - Grounding the PV generator.
 - Comply with the local requirements for grounding the PV modules and the PV generator. It is recommends connecting the generator frame and other electrically conductive surfaces in a manner which ensures continuous conduction and ground these in order to have optimal protection of system and persons.
-

-
- Prior to the application, please read this section carefully to ensure correct and safe application. Please keep the user manual properly.
 - Accessories only together with the inverter shipment are recommended here. Otherwise may result in a risk of fire, electric shock, or injury to person.
 - Make sure that existing wiring is in good condition and that wire is not undersized.
 - Do not disassemble any parts of inverter which are not mentioned in installation guide. It contains no user-serviceable parts. See Warranty for instructions on obtaining service. Attempting to service the inverter yourself may result in a risk of electric shock or fire and will void your warranty.
 - Keep away from flammable, explosive materials to avoid fire disaster. The installation place should be away from humid or corrosive substance.
 - Authorized service personnel must use insulated tools when installing or working with this equipment.
 - PV modules shall have an IEC 61730 class A rating.
 - Never touch either the positive or negative pole of PV connecting device.
 - Strictly prohibit touching both of them at the same time.
 - The unit contains capacitors that remain charged to a potentially lethal voltage after the MAINS , battery and PV supply has been disconnected.
 - Hazardous voltage will present for up to 5 minutes after disconnection from power supply.
 - CAUTION-RISK of electric shock from energy stored in capacitor, Never operate on the inverter couplers, the MAINS cables, Battery cables, PV cables or the PV generator when power is applied. After switching off the PV , battery and Mains, always wait for 5minutes to let the intermediate circuit capacitors discharge before unplugging DC ,battery inplug and MAINS couplers.
 - When accessing the internal circuit of inverter, it is very important to wait 5 minutes before operating the power circuit or demounting the electrolyte capacitors inside the device. Do not open the device before hand since the capacitors require time sufficiently discharge!
 - Measure the voltage between terminals UDC+ and UDC- with a multi-meter(impedance at least 1Mohm) to ensure that the device is discharged before beginning work (35VDC) inside the device.

Surge protection devices (SPDs) for PV installation











- Lightning will cause a damage either from a direct strike or from surges due to a nearby strike.
 - Induced surges are the most likely cause of lightning damage in majority of installations, especially in rural areas where electricity is usually provided by long overhead lines. Surge may be included on both the PV array conduction and the AC cables leading to the building.
 - Specialists in lightning protection should be consulted during the end use application. Using appropriate external lightning protection, the effect of a direct lightning strike into a building can be mitigated in a controlled way, and the lightning current can be discharged into the ground.
 - Installation of SPDs to protect the inverter against mechanical damage and excessive stress include a surge arrester in case of a building with external lightning protection system (LPS) when separation distance is kept.
 - To protect the DC system, surge suppression device (SPD type2) should be fitted at the inverter end of the DC cabling and at the array located between the inverter and the PV generator, if the voltage protection level (VP) of the surge arresters is greater than 1100V, an additional SPD type 3 required for surge protection for electrical devices.
 - To protect the AC system, surge suppression devices (SPD type2) should be fitted at the main incoming point of AC supply (at the consumer's cutout), located between the inverter and the meter/distribution system; SPD (test impulse D1) for signal line according I to EN 61632-1.
 - All DC cables should be installed to provide as short a run as possible, and positive and negative cables of the string or main DC supply should be bundled together.
-

-
- Avoiding the creation of loops in the system.
 - Spark gap devices are not suitable to be used in DC circuits once conducting, they won't stop conducting until the voltage across their terminals is typically more than 30 volts.
 - Anti-Islanding Effect Islanding effect is a special phenomenon that grid-connected PV system still supply power to the nearby grid when the voltage loss is happened in the power system. It is dangerous for maintenance personnel and the public. X1-Hybrid series inverter provide Active Frequency Drift(AFD) to prevent islanding effect.

PE Connection and Leakage Current

- The end-use application shall monitor the protective conductor by residual current operated protective device (RCD) with rated fault current $I_{fn} \leq 240\text{mA}$ which automatically disconnects the device in case of a fault. The device is intended to connect to a PV generator with a capacitance limit of approx 700nf.
 - Incorrect grounding can cause physical injury, death or equipment malfunction and increase electromagnetic.
 - Make sure that grounding conductor is adequately sized as required by safety regulations.
 - Do not connect the ground terminals of the unit in series in case of a multiple installation. This product can cause current with a d.c component, Where a residual current operated protective (RCD) or monitoring (RCM) device is used for protection in case of direct or indirect contact, only an RCD or RCM of type B is allowed on the supply side of this product. For United Kingdom
 - The installation that connects the equipment to the supply terminals shall comply with the requirements of BS 7671.
 - Electrical installation of PV system shall comply with requirements of BS 7671 and IEC 60364-7-712.
 - No protection settings can be altered.
 - User shall ensure that equipment is so installed, designed and operated to maintain at all times compliance with the requirements of ESQCR22(1)(a). For Australia and New Zealand
 - Electrical installation and maintenance shall be conducted by licensed electrician and shall comply with Australia National Wiring Rules. Battery Safety Instructions BD series inverter should be worked with high voltage battery, for the specific parameters such as battery type, nominal voltage and nominal capacity etc., please refer to section 4.3. As accumulator batteries may contain potential electric shock and short-circuit current danger, to avoid accidents that might be thus resulted, the following warnings should be observed during battery replacement:
 - 1: Do not wear watches, rings or similar metallic items.
 - 2: Use insulated tools.
 - 3: Put on rubber shoes and gloves.
 - 4: Do not place metallic tools and similar metallic parts on the batteries.
 - 5: Switch off load connected to the batteries before dismantling battery connection terminals.
 - 6: Only personal with proper expertise can carry out the maintenance of accumulator batteries.
-

EXPLANATION OF SYMBOL

Symbol	Explanation
	CE mark. The inverter complies with the requirements of the applicable CE guidelines.
	TUV certified.
	RCM remark.
	SAA certification.
	Beware of hot surface. The inverter can become hot during operation. Avoid contact during operation.
	Danger of high voltages. Danger to life due to high voltages in the inverter!
	Danger. Risk of electric shock!
	Observe enclosed documentation.
	The inverter can not be disposed together with the household waste. Disposal information can be found in the enclosed documentation.
	Do not operate this inverter until it is isolated from battery, mains and on-site PV generation suppliers.
	Danger to life due to high voltage. There is residual voltage existing in the inverter after powering off, which needs 5 min to discharge. <ul style="list-style-type: none"> • Wait 5 min before you open the upper lid or the DC lid.

This chapter follows the requirements of the European low voltage directives, which contains the safety instructions and conditions of acceptability for the end user system, which you must follow when installing, operating and servicing the unit. If ignored, physical injury or death may follow, or damage may occur to the unit. Read this before you work on the unit. If you are unable to understand the dangers, warnings, cautions or instructions, please contact an authorized service dealer before installing. Operating and servicing the unit. The Grid connected inverter meets the requirement stipulated in Low Voltage Directive (LVD) 2014/35/EU and Electromagnetic Compatibility (EMC) Directive 2014/30/EU. The unit is based on: EN 62109-1:2010;EN 62109-2:2011;IEC 62109-1(ed.1); IEC62109-2(ed.1);EN 61000-6-3:2007+A:2011;EN 61000-6-1:2007;EN 61000-6-2:2005. In case of installation in PV system, startup of the unit (i.e. start of designated operation) is prohibited until it is determined that the full system meets the requirements stipulated in EC Directive (2014/35/EU,2014/30/EU, etc.),The grid connected inverter leave the factory completely connecting device and ready for connection to the mains and PV supply ,the unit shall be installed in accordance with national wiring regulations. Compliance with safety regulations depends upon installing and configuring system correctly, including using the specified wires. The system must be installed only by professional assemblers who are familiar with requirements for safety and EMC. The assembler is responsible for ensuring that the end system complies with all the relevant laws in the country where it is to be used. The individual subassembly of the system shall be interconnected by means of the wiring methods outlined in national/inter national such as the national electric code (NFPA) No.70 or VDE regulation 0107.

INTRODUCTION

Hybrid Inverter series is a high quality inverter which can convert solar energy to AC energy and store energy into battery

The inverter can be used to optimize self consumption, store in the battery for future use or feed in to public grid. Work mode depends on PV energy and user's preference. It can provide power for emergency use during the grid lost by using the energy from battery and inverter(generated from PV).

System Diagram 1 (applies to most countries)

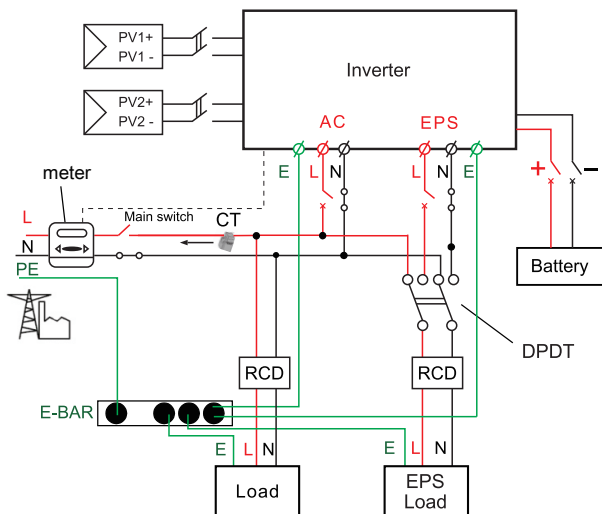

System Diagram 2 (applies to wiring rules AS/NZS_3000:2012 for Australia and New Zealand)

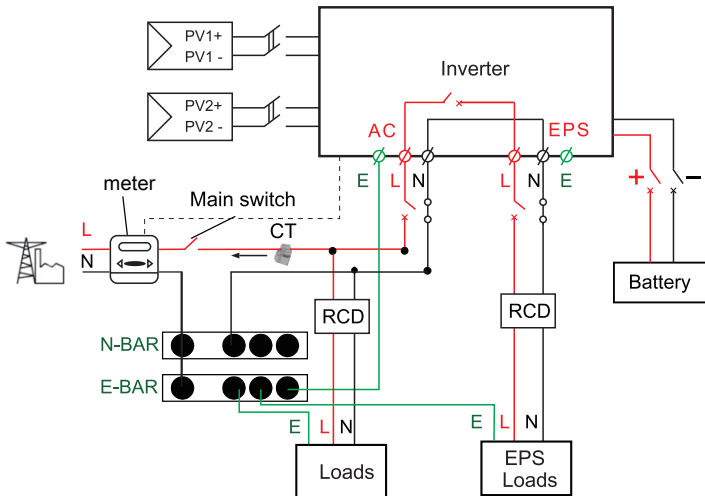

Note!

- The instrument and switch in the above figure are provided by users

Work Modes

Hybrid Inverter provides multiple work modes based on different requirements.

Work modes : Self-use



1. When PV, Grid, Battery is available:

A. Solar energy provides power to the loads as first priority, if solar energy is sufficient to power all connected loads, solar energy excess power will provides to charge battery, and then redundant power will feed to grid.



B. Solar energy provides power to the loads as first priority ,if solar energy is not sufficient to power all connected loads, battery energy will supply power to the loads at the same time.



C. Solar energy provides power to the loads as first priority ,if solar energy and battery are not sufficient to power all connected loads, utility energy (Main Grid) will supply power to the loads with solar energy at the same time.



2 .When PV, Grid is available (without battery):

A. Solar energy provides power to the loads as first priority ,if solar energy is sufficient, the excess power will feed to grid.



B. Solar energy provides power to the loads as first priority, if solar energy is not sufficient to power all connected loads, Grid energy will supply power to the loads at the same time.



3 .When PV, Battery is available (Grid is disconnected):

A. Solar energy provides power to the loads as first priority ,if solar energy is sufficient to power all connected loads, solar energy will provides to chargeb battery.



B. Solar energy provides power to the loads as first priority ,if solar energy is not sufficient to power all connected loads, battery energy and solar energy will supply power to the loads at the same time.

Work modes : Peak shift



1. When PV, Grid, Battery is available:

A. On charge time, solar energy will charge battery as first priority. The excess energy will supply power to the loads. If solar energy is sufficient to supply loads and charge battery, and if there's still some extra energy, then the excess power will feed the power to grid



B. On charge time, solar energy will charge battery as first priority, then the excess solar energy will supply power to loads. If solar energy is not sufficient to charge battery and supply loads, grid will supply all the connected loads with solar energy together.



C. On discharge time, solar energy provides power to the loads as first priority, if solar energy is sufficient to supply loads, and if there's still some extra energy from solar energy, then the excess power and battery will deliver the power to the grid at the same time.



D. In the period of no charge or discharge, the solar power supply loads at first priority, excess energy to the grid.

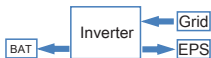

2. When Grid, Battery is available (PV is disconnected):

A. On charge time, grid will charge battery and supply power to the connected loads at the same time.



B. On discharge time, if load power is less than battery power, battery will supply power to loads as first priority, the excess power will be feed to grid.



C. On discharge time, if load power is more than battery power, battery and grid will supply power to the loads at the same time.

Work modes : Bat priority



1. When PV, Grid, Battery is available:

A. Solar energy will charge battery as first priority, if solar energy is excess, the excess power will supply load. If there's still some extra energy, then the excess power will feed the power to grid.



B. Solar energy will charge battery as first priority, if solar energy is excess, the excess power will supply load. If solar energy is not sufficient to charge battery and supply loads, grid will supply power to loads.



2. When Grid, Battery is available (PV is disconnected):

Grid will supply power to load and charge battery at the same time.

DIMENSION

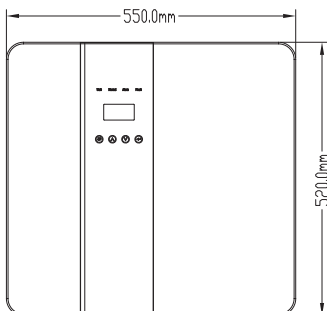

TERMINAL OF PV INVERTER

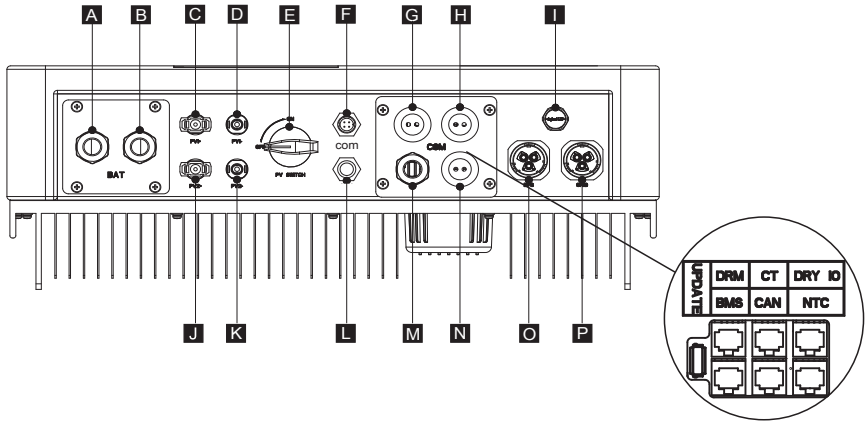

Object	Description	Object	Description
A/B	Battery +/Battery -	H	Grid current / DRY IO
C/D	PV1+/PV1-	M	USB port for upgrading
J/K	PV2+/PV2-	N	POWER CAN /LEAD-NTC
E	DC switch	I	Pressure valve
F	WiFi port for external WiFi	O	EPS output
L	Reserved port	P	Grid output
G	DRM/BMS	P	Grid output



Note!

- 1.The Update port: For on-premises upgrades.
- 2.The BMS port: BMS communication for lithium batteries.
- 3.The CT port: For external grid side CT to detect current size.
- 4.The DRM port, CAN port, NTC port and DRY IO port: Reserved port, temporarily unavailable

TECHNICAL DATA

1. DC input

MODEL	VT-66036103	VT-66036103	VT-66036103
Max. recommended DC power [W]	4600	4600	4600
Max. DC voltage[V]	500	500	500
Normal DC operating voltage[V]	360	360	360
MPPT voltage range [V]	125-500	125-500	125-500
MPPT voltage range@full load [V]	150-500	150-500	150-500
Max. input current [A]	14/14	14/14	14/14
Max. short circuit current [A]	14/14	14/14	14/14
Start input voltage [V]	125	125	125
Start output voltage [V]	150	150	150
No. of MPP trackers	2	2	2
Strings per MPP tracker	1	1	1
Backfeed current to PV array	0	0	0
DC disconnection switch	/	/	/

AC OUTPUT/INPUT

MODEL	VT-66036103		
AC OUTPUT			
Norminal AC power[VA]	3000/3600		
Max. apparent AC power[VA]	3000/3600		
Rated grid voltage(range)[V]	230 (176 to 270)		
Rated grid frequency[Hz]	50/60		
Norminal AC current[A]	13/16		
Max.AC current[A]	13/16		
Displacement power factor	0.8 leading...0.8 lagging		
Total harmonic distortion(THDI)	< 2%		
Load control	optional		
AC INPUT			
Norminal AC power[VA]	3000/3600		
Rated grid voltage(range)[V]	230(176 to 270)		
Rated grid frequency[Hz]	50/60		
Norminal AC current[A]	13/16		
Max.AC current[A]	13/16		
Displacement power factor	0.8 leading...0.8 lagging		
AC inrush current	35		

BATTERY PARAMETER

MODEL	VT-66036103		
Battery type	Lithium battery		
Battery voltage range[V]	42-59		
Recommended battery voltage[V]	48		
Max. charge/discharge current[A]	95/76.6		
Peak charge/discharge current[A]	95/76.6		
Communication interfaces	CAN/RS485/Wifi/LAN/DRM		
Reverse connect protection	Yes		

Efficiency, Safety and Protection (apply to version E,I)

MODEL	VT-66036103		
MPPT efficiency	99.90%		
Euro efficiency	97%		
Max. efficiency	97.60%		
Max. Battery charge efficiency	95%		
Max. Battery discharge efficiency	95%		
Safety & Protection			
Over/under voltage protection	YES		
DC isolation protection	YES		
Monitoring ground fault protection	YES		
Grid protection	YES		
DC injection monitoring	YES		
Back feed current monitoring	YES		
Residual current detection	YES		
Anti-islanding protection	YES		
Over load protection	YES		
Over heat protection	YES		

Efficiency, Safety and Protection (apply to version E,I)

MODEL	VT-66036103		
EPS rated power[VA]	3000/3600		
Max. EPS power[VA]	3000/3600		
EPS rated voltage, Frequency	230VAC, 50/60Hz		
EPS rated current[A]	13/16		
Max. EPS current[A]	13/16		
Switch time[s]	<500ms		
Total harmonic distortion(THDv)	<2%		
Parallel operation	Yes		
Compatible with the generator	Yes(signal provided only)		

General Data (apply to version E,I)

MODEL	VT-66036103
Dimension [W/H/D](mm)	550*520*200
Dimension of packing [W/H/D](mm)	665*635*330
Net weight [kg]	25
Gross weight [kg]	31
Installation	Wall-mounted
Operating temperature range[°C]	-25~+60 (derating at 45)
Storage temperature [°C]	-25~+60
Storage/Operation relative humidity	4%~100% (Condensing)
Altitude [m]	<2000
Ingress Protection	IP65(for outdoor use)
Protective Class	I
Night-time consumption	<3W
Over Voltage Category	II (MAINS), II (PV, Battery)
Pollution Degree	II
Cooling	Neutral
Noise level	< 40dB
Inverter Topology	non-isolated
Communication interface	CAN/RS485/Wifi/LAN/DRM

INSTALLATION

Check for Physical Damage Make sure the inverter is intact during transportation. If there is any visible damage, such as cracks, please contact your dealer immediately.

PACKING LIST

Open the package and take out the product, please check the accessories first. The packing list shown as below.

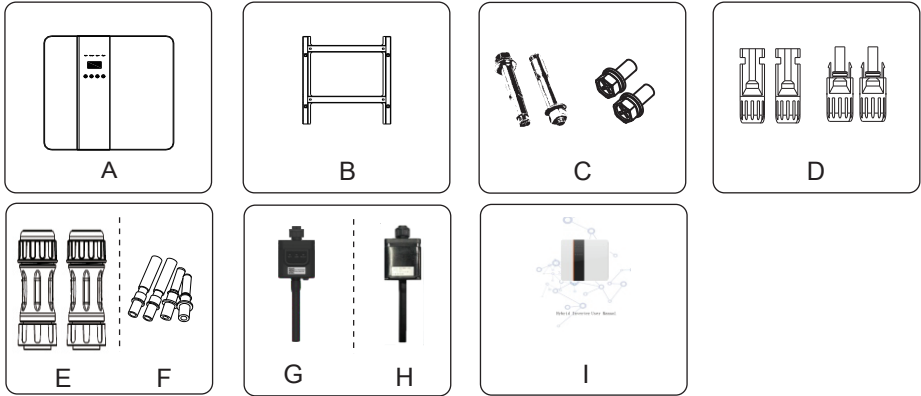

Object	Description
A	Inverter
B	Bracket
C	Expansion screws and pan-head screws
D	PV connectors (2*positive, 2*negative)
E	AC terminals
F	PV pin connectors (2*positive, 2*negative)
G	Wifi module (optional)
H	GPRS module (optional)
I	User manual

TOOLS REQUIRED FOR INSTALLATION

Installation tools: crimping pliers for binding post and RJ 45, screwdriver, manual wrench etc



SPACE REQUIREMENT

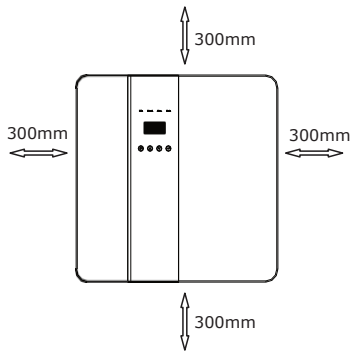

Table Available Space Size	
Position	Min.size
Left	300mm
Right	300mm
Top	300mm
Bottom	300mm
Front	300mm

Step 1: Screw the wall bracket on the wall

- 1.1. Place the bracket on the wall and mark down the position of the 4 holes.
- 1.2. Drill holes with driller, make sure the holes are deep enough (at least 60mm) to support the inverter.
- 1.3. Install the expansion tubes in the holes, and tighten them. Then install the wall bracket with the expansion screws.

Step 2: Place the inverter on the wall mounted bracket by holding the handle on the side.

Step 3: Tighten the fixing screws on both sides of the inverter.

Step 4: If necessary, customer can install an anti-theft lock on the left-bottom of the inverter.

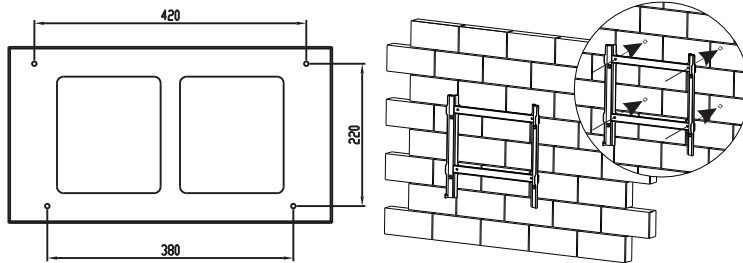

Step 1

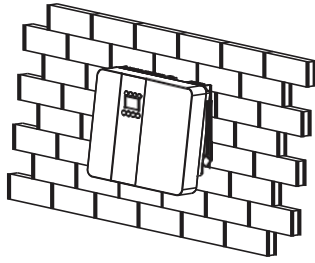

Step 2

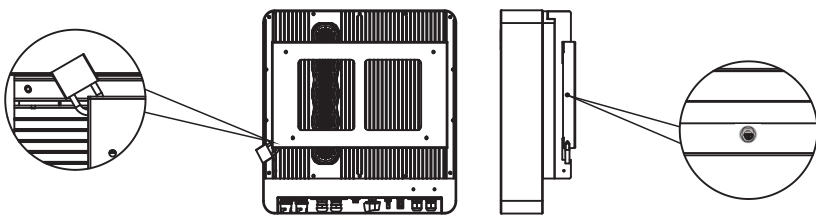

Step 3, Step 4

ELECTRICAL CONNECTION

Electrical connection diagram

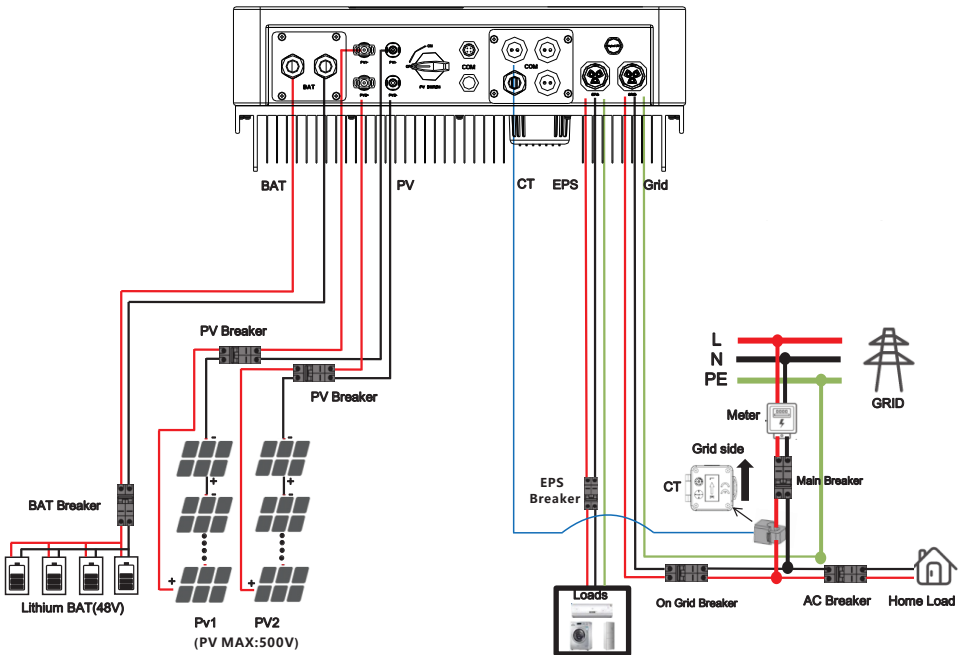

GRID CONNECTION AND EPS CONNECTION

Hybrid inverter are designed for single phase grid. Voltage is 220/230/240V, frequency is 50/60Hz. Other technical requests should comply with the requirement of the local public grid.

Table 1 Cable and Micro-breaker recommended

MODEL	VT-66036103
E VERSION CABLE	4-5 mm ²
E VERSION MICRO-BREAKER	20A
I VERSION CABLE	8-10mm ²
I VERSION MICRO-BREAKER	50A

Micro-breaker should be installed between inverter and grid, any load should not be connected with inverter directly.

Step1. Check the grid voltage.

- 1.1 Check the grid voltage and compare with the permissive voltage range (Please refer to technical data).
- 1.2 Disconnect the circuit board from all the phases and secure against re-connection.

Step2. Remove the waterproof lid from the grid port on the inverter.

Step3. Make AC and EPS wires.

- 3.1 Choose the appropriate wire(Cable size: refer to Table 1).
- 3.2 Reserve about 60mm of conductor material sectional area and remove 10mm of insulation from the end of wire.
- 3.3 Separate the docking screw cap of the AC terminal from the housing portion and insert stripped wires into AC terminal and tighten the screws with a hexagonal wrench.
- 3.4 Tighten the docking screw cap and housing portion of the AC terminal.

Step4.

Connect the AC connector to the GRID port of the inverter and tighten the screw cap .
Connect the LOAD connector to the EPS port of the inverter and tighten the screw cap .

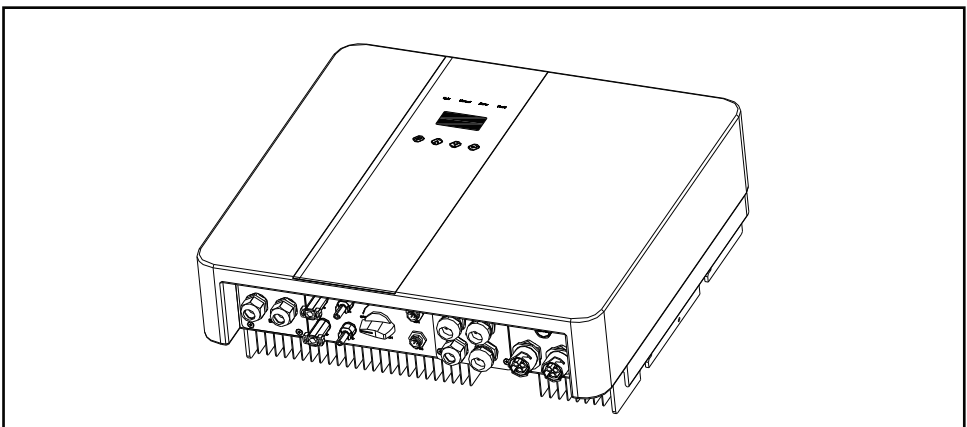

Step3 Cable Size: Refer to Tabel 4(page 24)

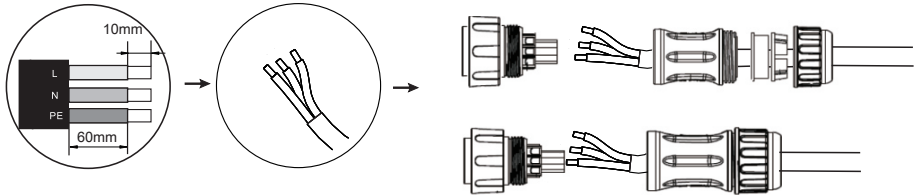

Step4 Note: Connect the AC connector to the GRID into grid interface.

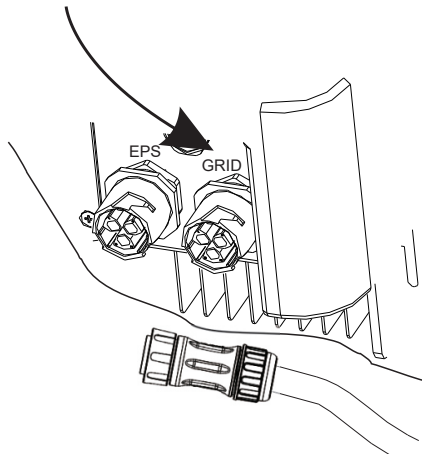

PV CONNECTION

Select PV modules with excellent function and reliable quality. Open-circuit voltage of module arrays connected in series should be <Max. DC input voltage; operating voltage should be conformed to MPPT voltage range.

MODEL	VT-66036103	VT-66036103	VT-66036103
Max. DC Voltage (V)	500	500	500
MPPT Voltage Range(V)	125-500	125-500	125-500



Warning!
PV module voltage is very high, which already achieve dangerous voltage range, please comply with electric safety rules when connecting.
Please do not make PV positive or negative ground!

CONNECTION STEPS:

Step 1. Checking PV module to ensure PV is in open circuit state and ensure the PV+ and PV- ports of the PV string are correct.

Step 2. Separating the DC connector.

Step 3. Wiring

3.1 Choose the 12 AWG wire to connect with the cold-pressed terminal.

3.2 Remove 10mm of insulation from the end of wire.

3.3 Insert the insulation into pin contact and use crimping plier to clamp it.

Step 4. Insert pin contact through the cable nut to assemble into back of the male or female plug. When

you feel or heard a "click" sound the pin contact assembly is seated correctly.

Step 5. Plug the PV connector into the corresponding PV connector on inverter.

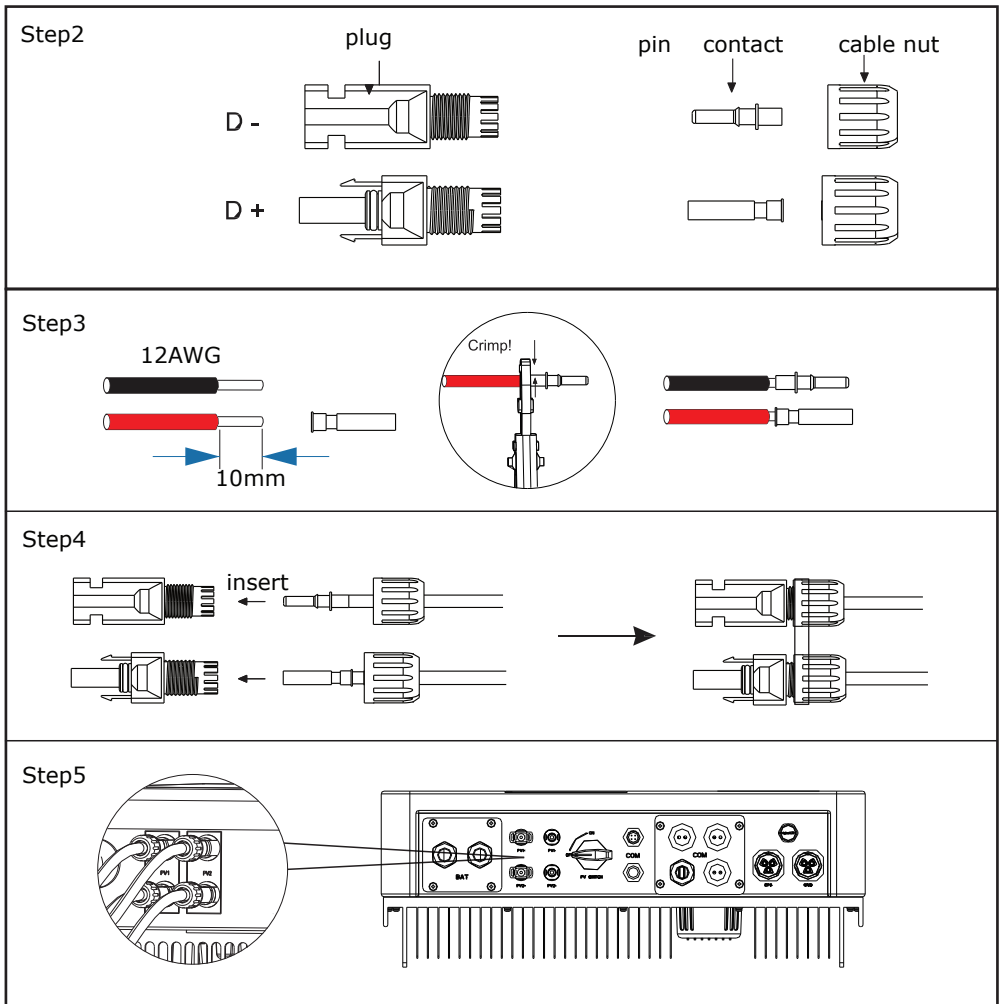

Battery Connection

Note

1. Before choosing battery, please note the maximum voltage of battery can not exceed 59V and the rated voltage of battery can not exceed 48V, and the battery communication should be compatible with Hybrid inverter.
2. Before connecting to battery, please install a nonpolarized DC(125A) breaker to make sure inverter can be securely disconnected during maintenance.
3. The connecting cable between the battery and the inverter shall be at least 4AWG.
4. The battery communication can only work when the battery BMS is compatible with the inverter.
5. To replace the battery, you need to turn off all switches and unplug the system communication line.
6. All the above wiring and operations must be carried out after the whole machine is powered down, and all of them need professional personnel to complete

Power Connection Steps:

- Step 1. Choose the 4AWG wire and strip the cable to 15mm.
- Step 2. Select two O-terminals with an aperture of M6.
- Step 3. Insert the stripping line into the O-terminal and clamp it with a crimping clamp.
- Step 4. Remove waterproof cover plate.
- Step 5. Disassemble the waterproof connector and pass the cable through the waterproof connector.
- Step 6. Connect the cable to the terminal of the inverter .
- Step 7. Assemble waterproof connectors and waterproof covers plate.

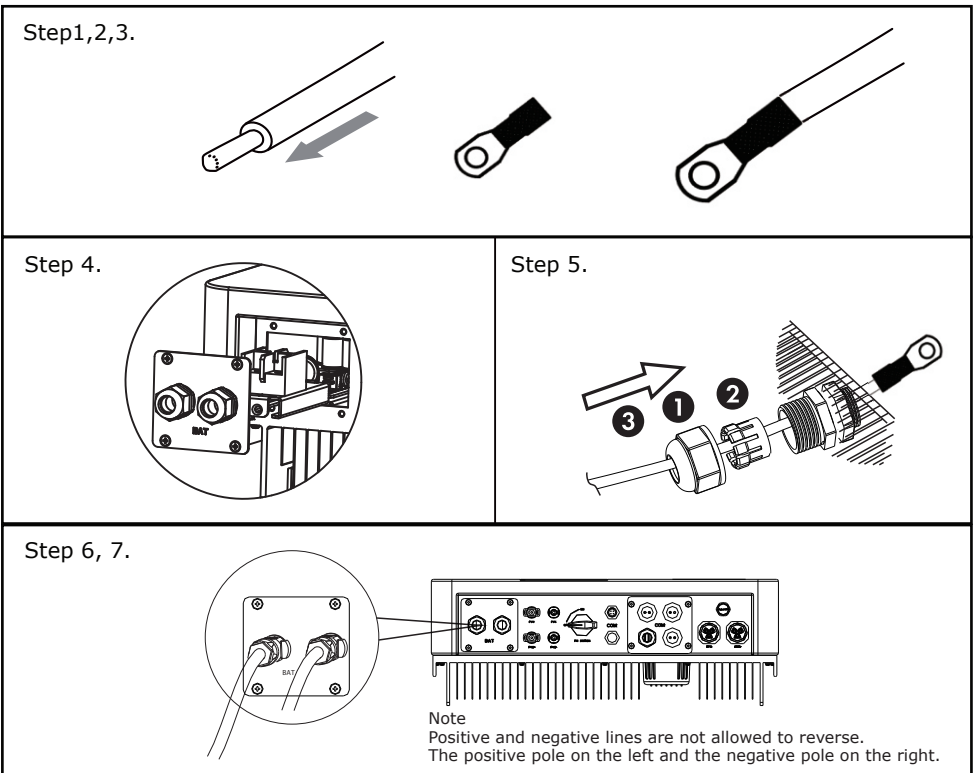

Communication interface definition

BMS PIN Definition

Communication interface between inverter and battery is RS485 or CAN with a RJ45 connector.

The wiring sequence of the crystal head conforms to the 568B standard: orange white, orange, green white, blue, blue white, green, brown white and brown.

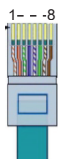

	PIN	1	2	3	4	5	6	7	8
CAN	Definition	X	X	X	BMS_CANH	BMS_CANL	X	X	X
Rs485	Definition	X	X	X	X	X	GND	BMS_485A	BMS_485B

DRY_IO (RJ45 PIN) Definition

Reserved dry contact interface of the inverter.



	1	2	3	4	5	6	7	8
COM1	NO 1	NC 1	DI 1	DI 2	COM2	NO 2	NC 2	

DRM Connection

DRM is provided to support several demand response modes by emitting control signals as below.

Note: Only PIN6(DRM0) is available now, and other PIN functions are being developed.



	1	2	3	4	5	6	7	8
DRM1/5	DRM2/6	DRM3/7	DRM4/8	+5V	DRM0	GND	GND	

WiFi And GPRS Connection(optional)

Inverter provides a WiFi port which can collect data from inverter and transmit it to monitoring-website by WiFi.

Step1. Plug Wifi into "COM" port at the bottom of the inverter.

Step2. Build the connection between the inverter and router.

Step3. Create a user account online. (Please check the WiFi user manual for more details).

DIAGRAM

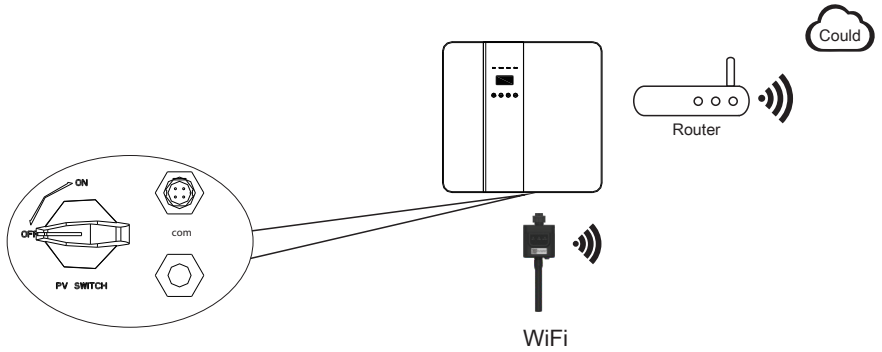

COM



1	2	3	4
+5V	RS485_A	RS485_B	GND

GPRS CONNECTION

GPRS connection interface is consistent with WIFI interface, Please refer to the GPRS user manual for detailed connection steps.

DIAGRAM

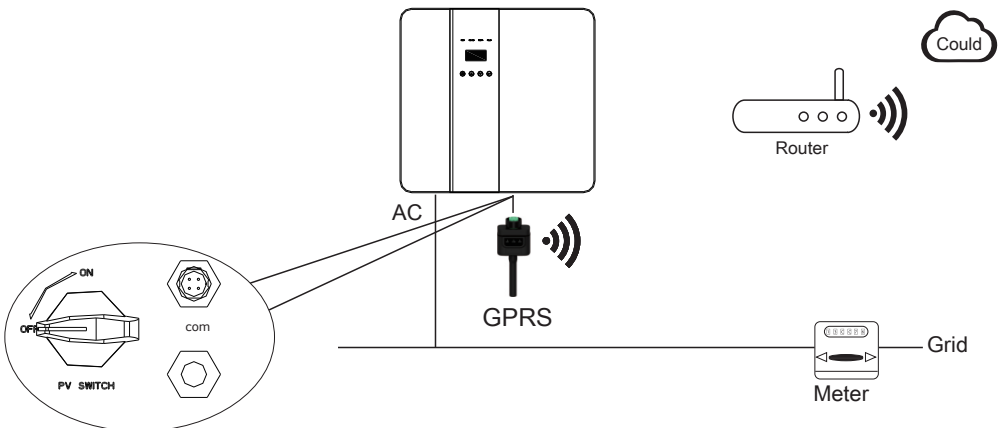

LCD INTERFACE AND SETTING

CONTROL PANEL

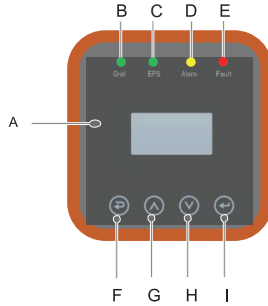

Object	Name	Description
A	LCD Screen	Display the information of the inverter.
B	Indicator LED	lit in green: The inverter is in grid mode. Off: The inverter is in not in grid mode.
C		lit in green: The inverter is in off-grid mode. Off: The inverter is in not in off-grid mode.
D		lit in Yellow: The inverter is in Warning . Off: The inverter has no Inverter Warning
E		lit in red: The inverter is in fault status. Off: The inverter has no errors.
F	Function Button	Esc: Return from current interface or function.
G		Up: Move cursor to upside or increase value.
H		Down: Move cursor to downside or decrease value.
I		Enter: Confirm the selection.

INSTRUCTIONS FOR LED INDICATOR

	Grid (Green)	EPS (Green)	Alarm (Yellow)	Fault (Red)
Initialization	off	off	off	off
Stand-by	off	off	off	off
Grid mode	on	off	off	off
Off-Grid	off	on	off	off
Bypass of mains	off	on	on	off
Fault	off	off	off	on

INSTRUCTIONS FOR THE USE OF THREE MODES

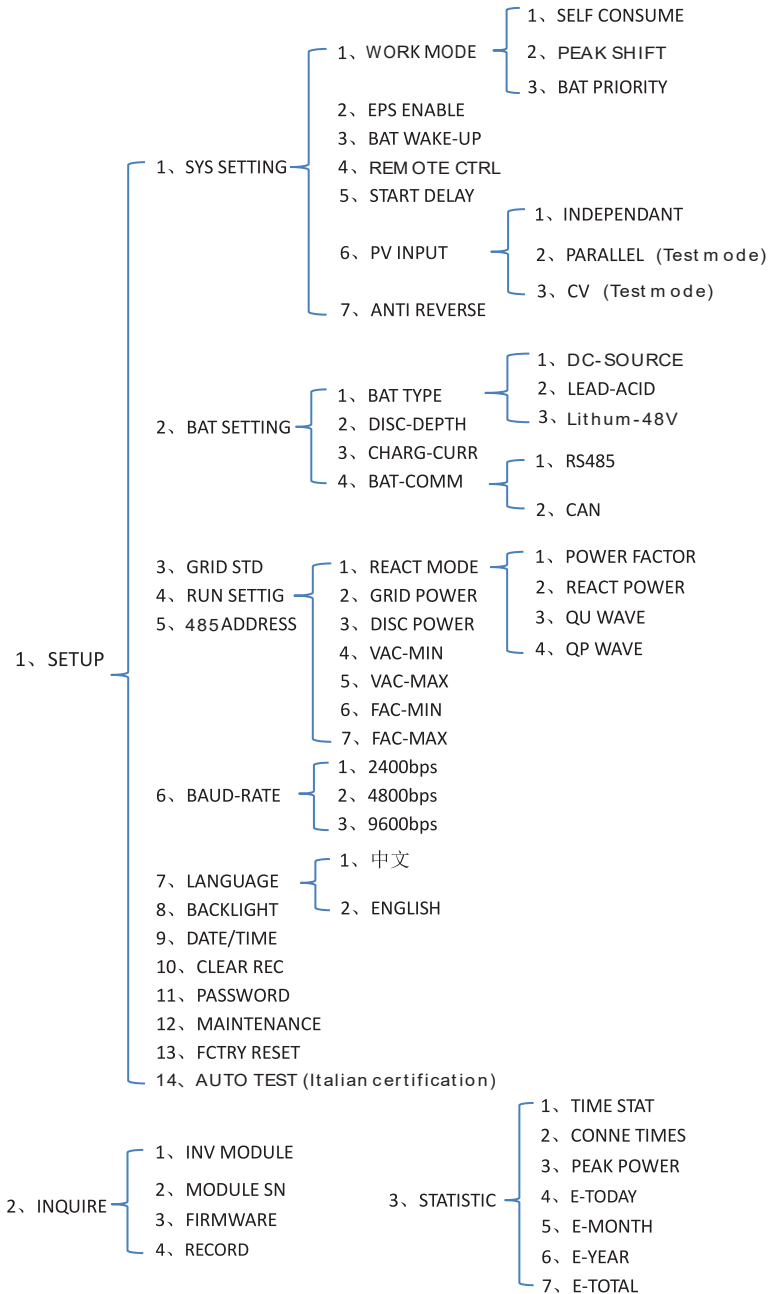

For example, Before selecting the mode, you can set it up according to the local power grid, PV input mode and battery type.

POWER GRID :

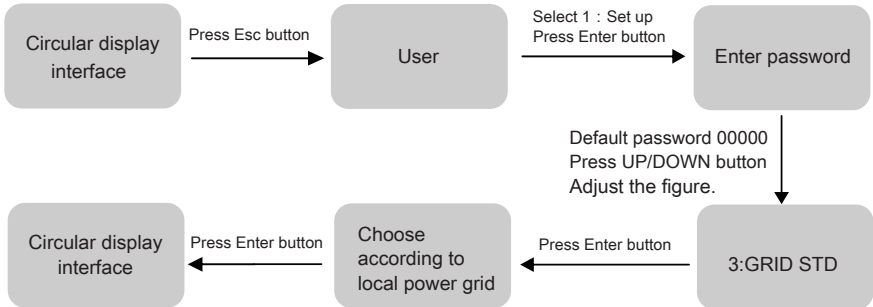

PV INPUT MODE

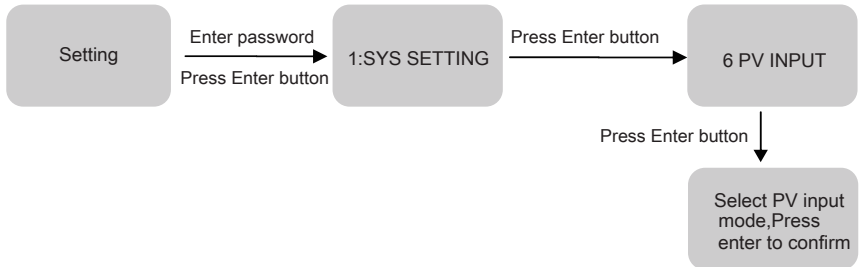



BATTERY PARAMETERS :



LCD INTERFACE

5.4.1 ERROR INFORMATION

Interface	Description
ERROR NO.  02:BatDisconnect 27:BMS Comm.fail	Numbers represent error codes and text is error information. Refer to Chapter 9 for specific contents. NOTE: When there is a lock mark  in the upper right corner of the screen, you cannot turn the page, you need to press Enter to unlock it first.

5.4.2 SYSTEM SETTING

Interface	Description
SYSTEM1 STATE : SELF CSM GRID : US-CA PV I/P : PARALL	State: Setting of the whole machine working mode. Including: SELF CONSUME, PEAK SHIFT and BAT PRIORITY. Refer to Chapter 3.3 for specific contents. Grid standard: Displays the grid standard actually set. PV input mode: The display value is the setting value of PV input type. Including: INDEPENDANT, PARALLEL, CV.

5.4.3 SYSTEM SETTING2

Interface	Description
SYSTEM2 BMS Com : CAN Anti Reve : DISA DOD : 80%	BMS Com: Battery Management System communication mode. Including: CAN, RS485. Anti Reve: Displays Whether Inverter isn't allowed to generate electricity to the Grid. Including: DISABLE,ENABLE DOD: Depth of battery discharge.

5.4.4 SYSTEM SETTING3

Interface	Description
SYSTEM3 EPS ENABLE: ENAB	EPS ENABLE: When the Grid and PV are powered off, Enable the battery to supply power to the load, default option is enable.

5.4.5 PV1 INPUT DISPLAY INTERFACE

Interface	Description
PV1 INPUT VOLT: 300V CURR: 10.00A POWER: 3000W	PV1 input real-time voltage, current and power.

5.4.6 PV2 INPUT DISPLAY INTERFACE

Interface	Description								
<table border="1"><tr><td colspan="2">PV2 INPUT</td></tr><tr><td>VOLT:</td><td>300V</td></tr><tr><td>CURR:</td><td>10.00A</td></tr><tr><td>POWER:</td><td>3000W</td></tr></table>	PV2 INPUT		VOLT:	300V	CURR:	10.00A	POWER:	3000W	PV2 input real-time voltage, current and power.
PV2 INPUT									
VOLT:	300V								
CURR:	10.00A								
POWER:	3000W								

5.4.7 DC VOLTAGE INTERFACE

Interface	Description						
<table border="1"><tr><td colspan="2">DC VOLTAGE</td></tr><tr><td>BUS:</td><td>384V</td></tr><tr><td>LeakCurr:</td><td>0mA</td></tr></table>	DC VOLTAGE		BUS:	384V	LeakCurr:	0mA	BUS: Real-time voltage of bus capacitor of the machine. LeakCurr: Real-time leak current of the machine.
DC VOLTAGE							
BUS:	384V						
LeakCurr:	0mA						

5.4.8 BATTERY INTERFACE

Interface	Description								
<table border="1"><tr><td colspan="2">BATTERY</td></tr><tr><td>VOLT:</td><td>300V</td></tr><tr><td>CURR:</td><td>10.00A</td></tr><tr><td>STA:</td><td>C D F</td></tr></table>	BATTERY		VOLT:	300V	CURR:	10.00A	STA:	C D F	Battery real-time voltage, current. STA: Battery status. C: Charge. D: Discharge. F: Full charge. Battery status depends on BMS instructions.
BATTERY									
VOLT:	300V								
CURR:	10.00A								
STA:	C D F								

5.4.9 BATTERY CURRENT INTERFACE

Interface	Description								
<table border="1"><tr><td colspan="2">BATTERY INFO</td></tr><tr><td>TYPE:</td><td>Lithium</td></tr><tr><td>TEMP:</td><td>26°C</td></tr><tr><td>SOC:</td><td>30%</td></tr></table>	BATTERY INFO		TYPE:	Lithium	TEMP:	26°C	SOC:	30%	TYPE: Battery type:(lead acid, lithium battery) TEMP: Battery temperature. SOC: Percentage of battery surplus capacity
BATTERY INFO									
TYPE:	Lithium								
TEMP:	26°C								
SOC:	30%								

5.4.10 BATTERY CURRENT INTERFACE

Interface	Description								
<table border="1"><tr><td colspan="2">BMS PRMETER</td></tr><tr><td>CHAR VOL:</td><td>0.0V</td></tr><tr><td>CHARGE:</td><td>50A</td></tr><tr><td>DISCHA:</td><td>50A</td></tr></table>	BMS PRMETER		CHAR VOL:	0.0V	CHARGE:	50A	DISCHA:	50A	CHAR VOL: Battery charging voltage. CHARGE: Battery charging current. DISCHA: Battery discharging current.
BMS PRMETER									
CHAR VOL:	0.0V								
CHARGE:	50A								
DISCHA:	50A								

5.4.11 GRID-CONNECTED

Interface	Description								
<table border="1"><tr><td colspan="2">GRID</td></tr><tr><td>VOLT:</td><td>0.0V</td></tr><tr><td>CURR:</td><td>0.00A</td></tr><tr><td>FREQ:</td><td>0.00Hz</td></tr></table>	GRID		VOLT:	0.0V	CURR:	0.00A	FREQ:	0.00Hz	VOLT: Grid real-time voltage. CURR: CT real-time current. FREQ: Grid real-time frequency.
GRID									
VOLT:	0.0V								
CURR:	0.00A								
FREQ:	0.00Hz								

5.4.12 INV

Interface	Description								
<table border="1"><tr><td colspan="2">INV</td></tr><tr><td>VOLT:</td><td>0.0V</td></tr><tr><td>CURR:</td><td>0.00A</td></tr><tr><td>FREQ:</td><td>0.00Hz</td></tr></table>	INV		VOLT:	0.0V	CURR:	0.00A	FREQ:	0.00Hz	VOLT: INV real-time voltage. CURR: INV real-time current. FREQ: INV real-time frequency.
INV									
VOLT:	0.0V								
CURR:	0.00A								
FREQ:	0.00Hz								

5.4.13 LOAD

Interface	Description								
<table border="1"><tr><td colspan="2">LOAD</td></tr><tr><td>VOLT:</td><td>0.0V</td></tr><tr><td>CURR:</td><td>0.00A</td></tr><tr><td>PERCENT:</td><td>0%</td></tr></table>	LOAD		VOLT:	0.0V	CURR:	0.00A	PERCENT:	0%	VOLT: LOAD real-time voltage. CURR: LOAD real-time current. PERCENT: LOAD real-time percentage.
LOAD									
VOLT:	0.0V								
CURR:	0.00A								
PERCENT:	0%								

5.4.14 POWER

Interface	Description						
<table border="1"><tr><td colspan="2">POWER</td></tr><tr><td>INV:</td><td>0.0W</td></tr><tr><td>GRID:</td><td>0.0W</td></tr></table>	POWER		INV:	0.0W	GRID:	0.0W	INV: INV power. GRID: Grid power.
POWER							
INV:	0.0W						
GRID:	0.0W						

5.4.15 POWER

Interface	Description								
<table border="1"><tr><td colspan="2">POWER</td></tr><tr><td>PV I/P:</td><td>0W</td></tr><tr><td>LOAD:</td><td>0W</td></tr><tr><td>BAT:</td><td>0W</td></tr></table>	POWER		PV I/P:	0W	LOAD:	0W	BAT:	0W	PV I/P: PV power. LOAD: LOAD power. BAT: BAT power.
POWER									
PV I/P:	0W								
LOAD:	0W								
BAT:	0W								

5.4.16 TEMPERATURE

Interface	Description
TEMPERATURE	INVER: INV Temperature. DCDC: DCDC Temperature. INSIDE: Internal ambient temperature of the machine.
INVER: 0°C	
DCDC: 0°C	
INSIDE: 0°C	

5.4.17 STATE

Interface	Description
STATE	System information: Display complete machine status information, Including: Initialization, Standby, PV grid connection, Grid connection of battery, Hybrid power supply, etc. INV: Displays the inverter status information. DCDC: Displays charging and discharging status information
SYS: STANDBY	
INV: STANDBY	
DCDC: STANDBY	

SETTINGAS

5.5.1 State

Interface	Description
<pre>USER → 1:SETUP 2:INQUIRE 3:STATISTIC</pre>	<p>SETUP: Press Enter to user settings interface.</p> <p>INQUIRE: Query machine model, serial number, software version.</p> <p>STATISTIC: View machine run statistics.</p>

5.5.2 SET P assword

Interface	Description
<pre>PASSWORD INPUT: XXXXX</pre>	<p>Enter the password required for setting. The default password is "00000".</p> <p>Press the Up or Down keys to adjust the number, press the Enter key to move the cursor forward, and press the Esc key move the cursor backward.</p>

5.5.3 Setup

Interface	Description
<pre>SETUP → 1:SYS SETTING 2:BAT SETTING 3:GRID STD 4:RUN SETTING 5:485 ADDRESS 6:BAUD RATE 7:LANGUAGE 8:BACKLIGHT 9:DATE/TIME 10:CLEAR REC 11:PASSWORD 12:MAINTENANCE 13:FCTRY RESET</pre>	<p>This interface is used for various information inquiry options.</p> <p>Press the Up/Down button to make the corresponding selection.</p> <p>Press Enter button to enter the selected menu.</p> <p>Press ESC button return to the user interface.</p> <p>There are 13 options in total.</p>

5.5.4.2 EPS en able

Interface	Description
<div style="border: 1px solid black; padding: 5px;"> EPS ENABLE 1:DISABLE → 2:ENABLE </div>	When the Grid and PV are powered off, Enable the battery to supply power to the load, default option is enable.

5.5.4.3 Battery wake-up

Interface	Description
<div style="border: 1px solid black; padding: 5px;"> WAKE-UP EN → 1:DISABLE 2:ENABLE </div>	When the battery is low and the battery relay has been disconnected, the inverter will send instructions to the battery forcibly sucking relay by BMS, and the inverter will charge. The default option is disabled. (Partial battery support)

5.5.4.4 REMOTE CTRL

Interface	Description
<div style="border: 1px solid black; padding: 5px;"> REMOTE CTRL → 1:DISABLE 2:ENABLE </div>	Remote control the inverter on or off. (Subsequent support...) The default option is disabled.

5.5.4.5 START DELAY

Interface	Description
<div style="border: 1px solid black; padding: 5px;"> START-UP DELAY INPUT: 60 UNIT: SEC </div>	The input value ranges from 20 to 300, which varies with different standards.

5.5.4.6 PV INPUT MODE

Interface	Description
<div style="border: 1px solid black; padding: 5px;"> INPUT MODE → 1.INDEPENDENT 2.PARALLEL 3.CV </div>	Setup of PV Input mode. The factory setting by default is Independent, When parallel input is set to be stand-alone mode, PV power will be imbalanced.

5.5.4.7 Anti Reverse

Interface	Description
Anti Reverse → 1.DISABLE 2.ENABLE	Anti Reverse: Whether Inverter isn't allowed to generate electricity to the Grid. The default option is disabled. It's means inverter allowed to generate electricity to the Grid

5.5.5 BAT SETTING

5.5.5.1 BAT SETTING

Interface	Description
BAT SETTING → 1.BAT TYPE 2.DISC-DEPTH 3.CHARG-CURR 4.BAT-COMM	This interface is used to select battery parameters. Press Up/Down button to move corresponding options; Press Enter button to enter the selected menu; Press ESC button to return to setting interface.

5.5.5.1.1 BATTTYPE

Interface	Description
BAT TYPE 1.DC-SOURCE → 2.LEAD-ACID 3.Lithium	This interface is used to select battery type. Press Up/Down button to move corresponding options; Press Enter button to enter the selected menu. Select the LEAD-ACID enter button to enter LEAD-ACID interface;

5.5.5.1.1.1 Lead-acid battery parameter

Interface	Description
LEAD-ACID → 1.CHARG-VOLT 2.BAT END VOLT 3:BAT OVP 4:BAT CAP	This interface is used to select LEAD-ACID battery parameter. Press Up/Down button to move corresponding options; Press Enter button to enter the selected menu;
CHARGE VOLT INPUT: 135.0 UNIT: V	This interface is used to set the lead acid battery charging voltage.

Interface	Description
BAT END VOLT INPUT: 108.0 UNIT: V	This interface is used to set the lead acid battery discharging voltage.
BAT OVP INPUT: 141.0 UNIT: V	This interface is used to set the lead acid battery Charge protection voltage.
BAT CAP INPUT: 0450 UNIT: AH	This interface is used to set the lead acid Battery capacity.

5.5.5.2 BAT-COMM

Interface	Description
BAT-COMM 1.RS485 →2.CAN	This interface is used to select battery communication. Press Up/Down button to move corresponding options; Press Enter button to enter the selected menu. The default option is CAN.

5.5.6 Grid standard

5.5.6.1 Grid std

Interface	Description
GRID STD 1.AU 2.AU-W 3.NZ 4.UK 5.VDE 6.KR 7.PHI 8.CN →9.US-CA 10.JP 11.CUSTOM	This interface is used to select Grid standard. Press Up/Down button to move corresponding options; Press Enter button to enter the selected menu. 1:AU--(Australia) 2:AU-W--(Western Australia) 3:NZ-- New Zealand 4: UK--United Kingdom 5:VDE—Germany 6:KR—Korea 7:PHI—Philippines 8:CN—China 9:US-CA—America 10:JP—Japan 11:CUSTOM--User defined

5.5.7 RUN SETTING

5.5.7.1 RUN SETTING

Interface	Description
<pre> RUN SETTING 1.REACT MODE →2.GRID POWER 3.DISC POWER 4.PV POWER 5.VAC-MIN 6.VAC-MAX 7.FAC-MIN 8.FAC-MAX 9.ACTIVE REP. </pre>	<p>This interface is used to select run setting. Press Up/Down button to move corresponding options; Press Enter button to enter the selected menu.</p>

5.5.7.2 REACT MODE

Interface	Description
<pre> RUN SETTING →1.REACT MODE 2.GRID POWER 3.DISC POWER </pre>	<p>This interface is used to select react mode. Press Up/Down button to move corresponding options; Press Enter button to enter the selected menu.</p> <p>The input value should range between L0.80 and L0.99 or C0.8 and C1.00.</p> <p>The input value should range between -60% and +60%, which varies with the standard.</p>
<pre> REACT MO DE →1.POWER FACT OR 2.REACT POWER R 3.QU WAVE 4.QP WAVE </pre>	
<pre> POWER FACTOR INPUT: C1.00 </pre>	
<pre> REACT POWER IN PUT: +00% </pre>	

5.5.7.3 GRID POWER

Interface	Description	
<table border="1"><tr><td>GRID PERCENT INPUT: 100%</td></tr></table>	GRID PERCENT INPUT: 100%	The input value is power percent of grid.
GRID PERCENT INPUT: 100%		

5.5.7.4 DISCHARGE POWER

Interface	Description	
<table border="1"><tr><td>DISC PERCENT INPUT: 100%</td></tr></table>	DISC PERCENT INPUT: 100%	The input value is power percent of battery discharge.
DISC PERCENT INPUT: 100%		

5.5.7.5 PV POWER

Interface	Description	
<table border="1"><tr><td>PV PERCENT INPUT: 100%</td></tr></table>	PV PERCENT INPUT: 100%	The input value is power percent of PV.
PV PERCENT INPUT: 100%		

5.5.7.6 VAC-MIN

Interface	Description	
<table border="1"><tr><td>GRID VOLT LOW INPUT: 150 UNIT: V</td></tr></table>	GRID VOLT LOW INPUT: 150 UNIT: V	The input value of Grid low voltage. It effect when grid mode choose custom.
GRID VOLT LOW INPUT: 150 UNIT: V		

5.5.7.7 VAC-MAX

Interface	Description	
<table border="1"><tr><td>GRID VOLT HIGH INPUT: 280 UNIT: V</td></tr></table>	GRID VOLT HIGH INPUT: 280 UNIT: V	The input value of Grid high voltage. It effect when grid mode choose custom.
GRID VOLT HIGH INPUT: 280 UNIT: V		

5.5.7.8 FAC-MIN

Interface	Description
GRID FREQ LOW INPUT: 57.0 UNIT: Hz	The input value of Grid low frequency. It effect when grid mode choose custom.

5.5.7.9 FAC-MAX

Interface	Description
GRID FREQ HIGH INPUT: 63.0 UNIT: Hz	The input value of Grid high frequency. It effect when grid mode choose custom.

5.5.8.10 ACTIVE REF.

Interface	Description
ACTIVE Type 1.PWR-VOLT RES → 2.PWR-FREQ RES 3.PFC-VOLT RES 4.PFC-FREQ RES 5.Reserved1 6.Reserved2 7.Reserved3 8.Reserved4	This interface is used to select active reference. Press Up/Down button to move corresponding options; Press Enter button to enter the selected menu. Each menu have enable or disable, set it when you need. All default are enable.

5.5.8 485 Add res

5.5.8.1 485 Add res

Interface	Description
485 ADDRESS INPUT: 1	This interface is used to select 485 address.

5.5.7.8 FAC-MIN

Interface	Description
GRID FREQ LOW INPUT: 57.0 UNIT: Hz	The input value of Grid low frequency. It effect when grid mode choose custom.

5.5.7.9 FAC-MAX

Interface	Description
GRID FREQ HIGH INPUT: 63.0 UNIT: Hz	The input value of Grid high frequency. It effect when grid mode choose custom.

5.5.8.10 ACTIVE REF.

Interface	Description
ACTIVE Type 1.PWR-VOLT RES →2.PWR-FREQ RES 3.PFC-VOLT RES 4.PFC-FREQ RES 5.Reserved1 6.Reserved2 7.Reserved3 8.Reserved4	This interface is used to select active reference. Press Up/Down button to move corresponding options; Press Enter button to enter the selected menu. Each menu have enable or disable, set it when you need. All default are enable.

5.5.8 485 Add res

5.5.8.1 485 Add res

Interface	Description
485 ADDRESS INPUT: 1	This interface is used to select 485 address.

5.5.9 485 BAUD RATE

5.5.9.1 BAUD RATE

Interface	Description
<pre>SELECT → 1.2400 bps 2.4800 bps 3.9600 bps</pre>	This interface is used to select 485 baud rate.

5.5.10 LANGUAGE

5.5.10.1 LANGUAGE

Interface	Description
<pre>LANGUAGE 1.Chinese → 2.English</pre>	This interface is used to select language.

5.5.11 BACKLIGHT

5.5.11.1 BACKLIGHT

Interface	Description
<pre>LIGHT TIME INPUT: 20 UNIT: SEC</pre>	This interface is used to set light time.

5.5.12 DATE/TIME

5.5.12.1 DATE/TIME

Interface	Description
<pre>DATE/TIME DATE: 2021-12-25 TIME: 22:30:00 WEEK: Saturday</pre>	This interface is used to set date and time.

5.5.13 CLE ARR EC

5.5.13.1 Clea r history

Interface	Description
<pre>DEL REC → 1.CANCEL 2.CONFIRM</pre>	This interface is used to clear operation history.

5.5.14 P ASS WORD

5.5.14.1 P ASSW ORD

Interface	Description
<pre>PASSWORD OLD: XXXXX NEW: XXXXX CONFIRM: XXXXX</pre>	This interface is used to set password.

5.5.15 M AINTE NA NCE

5.5.15.1 MA IN TENA NCE

Interface	Description
<pre>PASSWORD INPUT: XXXXX</pre>	This interface is used to enter maintenance.

5.5.16 F CTR Y R ESET

5.5.16.1 FACTOR Y R ESET

Interface	Description
<pre>FACTORY RESET → 1.CANCEL 2.CONFIRM</pre>	This interface is used to reset the inverter.

5.6 INQUIRE

5.6.1 INQUIRE

Interface	Description
<pre>INQUIRE -> 1.INV MODULE 2.MODULE SN 3.FIRMWARE 4.RECORD 5.DIAGNOSE</pre>	<p>Press Up/Down button to move corresponding options; Press Enter button to jump to the selected menu. Press ESC button to return to other interface.</p>

5.6.1.1 INV MODULE

Interface	Description
<pre>MODEL 12K</pre>	<p>This interface show inverter model..</p>

5.6.2 MODULE SN

Interface	Description
<pre>S / N GUID: XXXXXXXX XXXXXXXXXXXXXXXX SN:XXXXXXXXXXXX</pre>	<p>This interface show module SN.</p>

5.6.3 FIRMWARE

Interface	Description
<pre>FIRMWARE ARM: V1.XX.XX DSP: V1.XX.XX</pre>	<p>This interface show Software version.</p>

5.6.4 RUNNING RECORDS

Interface	Description
<div style="border: 1px solid black; padding: 5px;"> REC(01) 02:Batdisconnect UP: 12-25 23:00 DOWN: </div>	This interface show running recodes.

5.6.5 DIAGNOSE

Interface	Description
<div style="border: 1px solid black; padding: 5px;"> DIAGNOSE 000000 000000 000000 000000 000000 000000 </div>	Factory internal use.

5.7 STATISTIC

5.7.1 STATISTIC

Interface	Description
<div style="border: 1px solid black; padding: 5px;"> STAT. → 1.TIME STAT. 2.CONNE.TIMES 3.PEAK POWER 4.E-TODAY 5.E-MONTH 6.E-YEAR 7.E-TOTAL </div>	This interface show inverter operation statistic. 1. Inverter operation and Grid-connection time statistic. 2. Inverter Grid-connection times statistic. 3. Displays power peak in history and for the day. 4. Displays statistic for the day (KWH). 5. Displays statistic for the month (KWH). 6. Displays statistic for the year (KWH). 7. Displays statistic of the inverter (KWH).

Note: 1. E-TODAY/MONTH/ YEAR/TOTAL → INPUT → PV/GRID (Consumption)/BATD(Battery discharge)
 → OUTPUT → BATC(Battery charge)/GRID(Generation)/
 CNSUM (Load consume)

2. If the inverter shut down before 24:00 on that day, and the day statistic will not be stored.

AUTOTEST FAST

1. SETUP	Press the Enter button and default password 00000
↓	
14. AUTO TEST	press the Enter button to start
Testing 59.S1...	
↓	Wait
Test 59.S1 OK!	
↓	Wait
Testing 59.S2...	
↓	Wait
Test 59.S2 OK!	
↓	Wait
Testing 27.S1...	
↓	Wait
Test 27.S1 OK!	
↓	Wait
Testing 27.S2...	
↓	Wait
Test 27.S2 OK!	
↓	Wait
Testing 81>S1	
↓	Wait
Test 81>S1 OK!	
↓	Wait
Testing 81>S2...	
↓	Wait
Test 81>S2 OK!	
↓	Wait
Testing 81<S1...	
↓	Wait
Test 81<S1 OK!	
↓	Wait
Testing 81<S2...	
↓	Wait
Test 81<S2 OK!	
↓	Wait
Auto Test OK!	
↓	
59.S1: 228V 902ms	
↑↓	Press the up/down button to page through the test results
59.S2: 229V 204ms	

↑↓
27.S1: 228V 408ms
↑↓
27.S2: 227V 205ms
↑↓
81>.S1 49.9Hz 103ms
↑↓
81>.S2 49.9Hz 107ms
↑↓
81<.S1 50.0Hz 105ms
↑↓
81<.S2 50.1Hz 107ms

Press the up/down button to page through the test results

Press the up/down button to page through the test results

Press the up/down button to page through the test results

Press the up/down button to page through the test results

Press the up/down button to page through the test results

Press the up/down button to page through the test results

Object	Description
27.S1	Under voltage protection
27.S2	Under voltage protection
59.S1	Over voltage protection
59.S2	Over voltage protection
81<S1	Under frequency protection
81<S2	Under frequency protection
81>S1	Over frequency protection
81>S2	Over frequency protection

FAULT DIAGNOSIS AND SOLUTIONS

The inverter is easy to maintain. When you encounter the following problems, please refer to the Solutions below, and contact the local distributor if the problem remains unsolved. The following table lists some of the basic problems that may occur during the actual operation as well as their corresponding basic solutions.

FAULT DIAGNOSIS TABLE

Content	Codes	Solutions
DischgOverCur	00	Battery discharge over current. (1) Nothing need to do, Wait one minute for the inverter to rest art. (2) Check whether the load is in compliance with the specification. (3) Cut off all the power and shut down all the machines; disconnect the load and plug in to restart machines, then check
Over Load	01	The load power is greater than other power(PV,BAT). (1) Check whether the load is in compliance with the maximum power of the machine. (2) Cut off all the power and shut down all the machines; disconnect the load and plug in to restart machines, then check whether the load is short circuited if the fault has been eliminated. (3) Contact customer service if error warning continues.
BatDisconnect	02	Battery Disconnect. (Battery voltage not identified) (1) Check whether the battery is connected. (2) Check if battery wiring port is open circuited. (3) Contact customer service if error warning continues.
BatUnder Vol	03	Battery voltage low that normal range. (1) Checking System Settings, If so, power off and rest art. (2) Check if the grid power down. If so, waiting for the grid power up, the inverter will automatically charge. (3) Contact customer service if error warning continues.
BatLow capacity	04	Battery Low that setting capacity.(SOC < 100% -DOD)
BatOverVol	05	The battery voltage is greater than the Inverter maximum voltage. (1) Checking System Settings, If so, power off and rest art. (2) Contact customer service if error warning continues.
Grid low vol	06	Grid voltage is abnormal (1) Check if the grid is abnormal.
Grid over vol	07	(2) Restart the inverter and wait until it functions normally. (3) Contact customer service if error warning continues.

Grid low freq	08	Grid Frequency is abnormal. (1) Check if the grid is abnormal.
Grid overFreq	09	(2) Restart the inverter and wait until it functions normally. (3) Contact customer service if error warning continues.
gfci over	10	Inverter GFCI exceeds standard. (1) Check PV string for direct or indirect grounding phenomenon. (2) Check peripherals of machine for current leakage. (3) Contact the local inverter customer service if fault remains unrecovered.
bus under vol	13	BUS voltage is lower than normal. (1) Check the input mode setting is correct. (2) Restart the inverter and wait until it functions normally. (3) Contact customer service if error warning continues.
bus over vol	14	BUS voltage is over maximum value.. (1) Check the input mode setting is correct. (2) Restart the inverter and wait until it functions normally.
Inv over cur	15	The inverter current exceeds the normal value. (1) Restart the inverter and wait until it functions normally.
Chg over cur	16	Battery charge current over than the Inverter maximum voltage. (1) Restart the inverter and wait until it functions normally.
Bus vol osc	17	Bus voltage instability. (1) Check the input and output mode setting is correct. (2) Restart the inverter and wait until it functions normally.
Inv under vol	18	INV voltage is abnormal (1) Check if the INV voltage is abnormal.
Inv over vol	19	(2) Restart the inverter and wait until it functions normally. (3) Contact customer service if error warning continues.
InvFreqAbnor	20	INV frequency is abnormal (1) Check if the INV frequency is abnormal. (2) Restart the inverter and wait until it functions normally. (3) Contact customer service if error warning continues.
igbt temp high	21	The inverter temperature is higher than the allowed value (1) Cut off all the power of the machine and wait one hour, then turn on the power of the machine.
bat over temp	23	Battery temperature is higher than the allowed value. (1) Disconnect the battery and reconnect it after an hour.
bat UnderTemp	24	Battery temperature is low than the allowed value. (1) Check the ambient temperature near the battery to see if it meets the specifications.
BMS comm.fail	27	Communication between lithium battery and inverter is abnormal. (1) Check the cable, crystal, Line sequence. (2) Checking the Battery switch.

Fan fail	28	Fan fail (1) Check whether the Inverter temperature is abnormal. (2) Check whether the fans run properly .(If you can see it)
Grid Phase err	30	The grid fault phase. (1) Check power grid wiring
Arc Fault	31	PV Arc Fault (1) Check Photovoltaic panels , PV wire. (2) Contact customer service if error or warning continues.
bus soft fail	32	(1) Restart the inverter and wait until it functions normally. (2) Contact customer service if error or warning continues.
inv soft fail	33	
bus short	34	
inv short	35	
fan fault	36	Fan fault. (1) Check whether the Inverter temperature is abnormal. (2) Check whether the fans run properly .(If you can see it)
PV iso low	37	(1) Check if the PE line is connected to the inverter and is connected to the ground. (2)Contact customer service if error or warning continues.
Bus Relay Fault	38	(1) Restart the inverter and wait until it functions normally. (2) Contact customer service if error or warning continues.
Grid Relay Fault	39	
EPS rly fault	40	
Gfci fault	41	
Selftest fail	44	
System fault	45	
Current DCover	46	
Voltage DCover	47	

Note: If an error occurs that is not listed in the table, Please Contact customer service.