

INSTRUCTION MANUAL

ENERGY STORAGE POWER SUPPLY

TECHNICAL DATA

Model	VT-2002
Battery capacity	2016Wh
Net Weight	25Kg
Ac Rated Output	2000W
AC Input	1600W
Solar Charge	DC: 12-60V Max 700W solar panel
AC Output	230V, Pure Sine Wave 2000W, Peak 4000W
Telescoping handle	1.2m
Auxiliary Charge Output	13.5V 9A (Max 100W)
Dimension	470x367x292mm
USB Output Port	5v 2.4A
QC Output	5V/9V/12V/18W
USB-C Output	5V 3A/9V 3A/12V 3A /15V 3A/ 20V3.25A PD65W
Wireless Charging Output	15W
Cycle Life	Cycled > 2000 LiFePO4 Battery

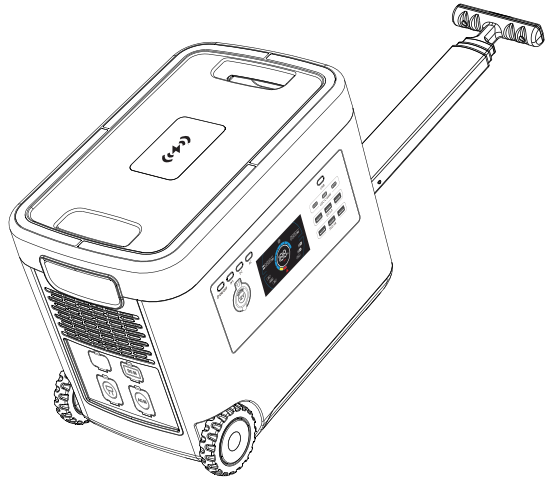

INTRODUCTION

Thank you for selecting and buying V-TAC Product. V-TAC will serve you the best. Please read these instructions carefully & keep this user manual handy for future reference. If you have any another query, please contact our dealer or local vendor from whom you have purchased the product. They are trained and ready to serve you at the best.



Multi-Language Manual QR CODE

Please scan the QR code to access the manual in multiple languages.

WARNING

1. Please make sure to turn off the power before starting the installation.
2. Installation must be performed by a qualified electrician.
3. Please read all instructions before using this product.
4. In order to reduce the risk, close supervision is required when using this product near children.
5. The use of accessories recommended or sold by non professional product manufacturers may lead to the risk of electric shock.
6. When the product is not in use, please pull the power plug out of the product socket.
7. It is forbidden to dismantle the product, which may lead to unpredictable risks such as fire, explosion or electric shock.
8. Do not use damaged wires or plugs or damaged output cables to use the product, which may cause electric shock.
9. Please charge the product in a well ventilated place. Do not restrict the ventilation of the product in any way.
10. Please put the product in a well ventilated and dry place to avoid the risk of electric shock due to water intrusion.
11. It is forbidden to expose the product to fire or temperature higher than 130°C, which may lead to fire, explosion and other safety accidents.
12. It is forbidden to use or place the product under high temperature (direct hot sunshine or hot car interior), otherwise the internal battery may overheat, catch fire or function failure, shorten the service life and other risks.
13. Please charge the product every three months to prevent the battery from running out.



This marking indicates that this product should not be disposed of with other household wastes.



Caution, risk of electric shock.



PACKAGING LIST

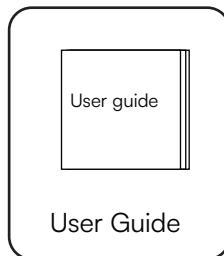
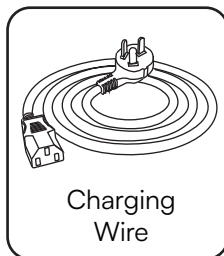
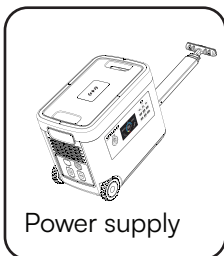

PARTS & DESCRIPTION

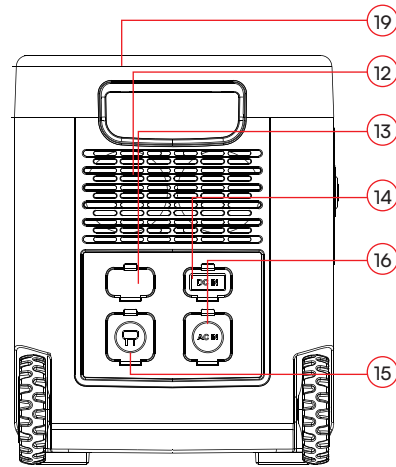
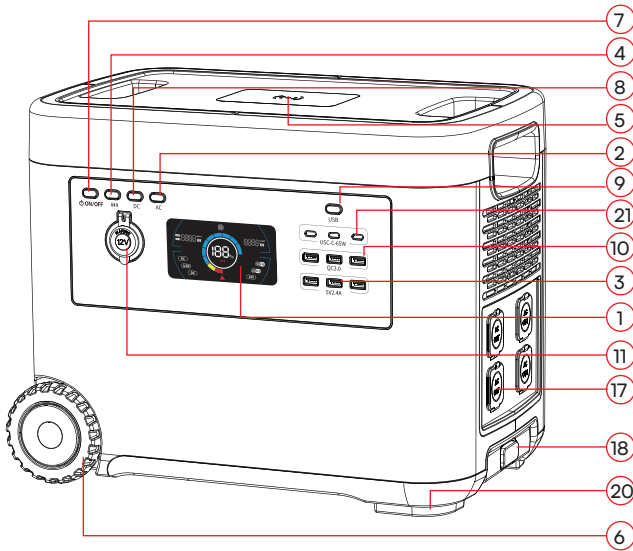





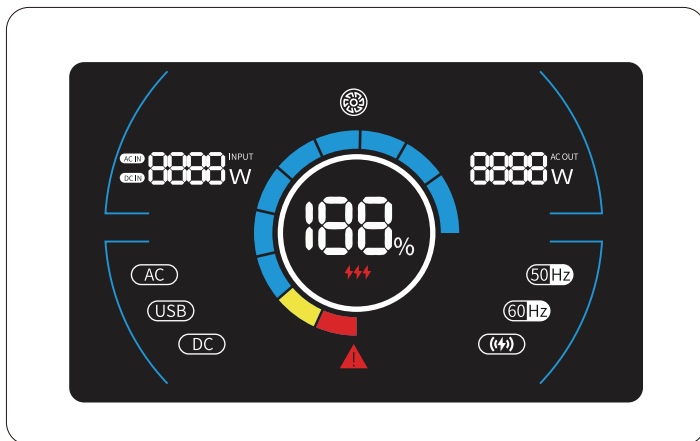





- 1 LCD Screen
- 2 AC Switch
- 3 5V/2.4A Quick Charge
- 4 Wireless charging Switch
- 5 15W - Wireless charging
- 6 Rollable wheels
- 7 Power Switch (click on start, press 3 seconds to shut down)
- 8 DC Switch
- 9 USB Output Switch
- 10 QC3.0 Output
- 11 Auxiliary Charge Output
- 12 Cooling outlet
- 13 Wire control interface
- 14 DC charging
It can be charged by solar energy
- 15 Safety Switch
- 16 AC fast charging
- 17 230V output
- 18 Telescoping handle
- 19 Portable Handle
- 20 Cushion Foot Pad
- 21 PD65W-Output

PARTS & DESCRIPTION



ICONS AND DESCRIPTION

	Equipment failure, please restart
	AC Output Power
	Output Power (AC/DC)
	Output Frequency 50Hz
	Output Frequency 60Hz
	AC working indicator
	USB working indicator
	DC working indicator
	Wireless charging working
	Cooling Fan working

PRECAUTIONS FOR USE

1. ⑦ Press the button, the screen lights up, about 60 seconds after the screen backlight automatically closed.
2. When ②④⑧⑨ the button is pressed, the output port is turned on to power the device.
3. When the power output port is not used, press the 2,4,8,9 button to turn it off to save power.
4. Low temperature may affect the battery capacity of the product, the product can be charged in the temperature range of 0 ~ 40 °C, in the temperature range of -10 ~ 40°C for equipment use.
5. The first use of the product is recommended to be fully charged, to avoid the lack of power to your use of inconvenience. After the device is fully charged, the fan will continue to work for about 2 minutes after the charging power cord is unplugged, which is used for cooling the device (the specific time may vary with the scene temperature) , pay attention to prevent dust particles or foreign matter from being inhaled into the equipment, otherwise it will easily lead to internal equipment damage.
6. After the discharge is terminated, the device fan will continue to work to reduce the device temperature to a reasonable temperature for about 30 minutes (the time may vary with the scene temperature) . At the same time charge and discharge, current more than 15A or equipment temperature is too high, will trigger automatic power-off protection.
7. During the charging and discharging process, please connect the device with the charging and discharging device, then turn on the charging and discharging. Otherwise, there might be a spark.

CHARGING MODE

Before using or storing the product, please use the charger to charge the product. When charging, the indicator light is blue. The LED screen will display the current charging ratio and charging power. When the LED screen shows 100% power, it means full charge. The charging process is about 2 hours. The current power can be viewed through the LED screen.



Standard charger,
about 2 hours



Car charger
about 2 hours



700W solar photovoltaic panel,
about 5 hours.

(the charging time is determined by the intensity of sunlight).
Support solar photovoltaic panel MPPT function charging (12-60V)

The above data are from the laboratory. The test data may vary due to the use environment, use method and other factors, and the charging time will be different.

FAQS

1. Can the product be brought on the plane?

No, because this product is a lithium battery product. According to the international air transport standard regulations, carrying lithium battery products can not exceed 100Wh.

2. If the power of the equipment is within the rated output power range of the product, it cannot be used?

a. The power consumption of the product is less than 20%; it needs to be supplemented.

b. When some equipments start, the products which are larger than the peak value of rated power cannot be used;

3. Why is there sound when using it?

The product adopts air cooling system, and the built-in fan is better to help product heat dissipation. It is normal to have slight noise when using.

4. Is the charger heating normal when charging?

Charging charger heating is a normal phenomenon, standard charger in line with national safety standards, you can rest assured to use!

TROUBLESHOOTING

FAULT PHENOMENON	TROUBLESHOOTING	SOLUTIONS
The product cannot be charged	1. The charger and product are not in good contact with the mains power supply (the charging indicator is not on at this time)	Check whether the charger and product are in good contact with the main power
	2. The contact is good, but the charging indicator is not on	If the charger is broken, please contact the customer service
	3. If the charging indicator light is on, it still can't be charged	If the product is broken, please contact the customer service
The product has no output	1. The connection line between the equipment and the product is not plugged in properly	Make the equipment well connected with the product
	2. The output port switch is not turned on	Turn on the port output switch, and the indicator light will be on
	3. Low power consumption	Charging the product
	4. There is no output after eliminating according to 1.2.3 above	If the product is broken, contact the customer service for handling
With device output interrupt	1. The nominal power or instantaneous starting power of the equipment used is greater than the power of the product	Select higher power energy storage products
	2. If the equipment used is short circuit, an alarm symbol will appear on the display screen, an alarm sound will be send and the product will automatically turn off the output within 15 seconds	It is not a product problem. It is recommended to replace the equipment.
	3. The output will still be turned off after removing according to the above 1.2 point	If the product is broken, contact the after-sales department for handling