

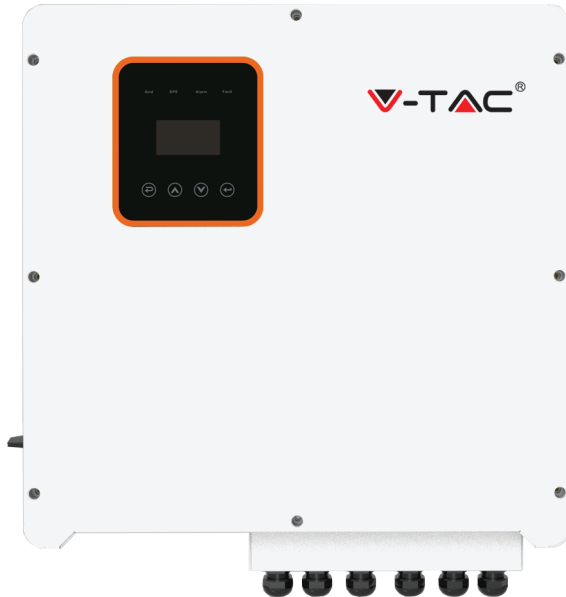

WEEE Number: 80133970

INSTRUCTION MANUAL

HYBRID SOLAR INVERTER SINGLE PHASE



INTRODUCTION

Thank you for selecting and buying V-TAC Product. V-TAC will serve you the best. Please read these instructions carefully & keep this user manual handy for future reference. If you have any another query, please contact our dealer or local vendor from whom you have purchased the product. They are trained and ready to serve you at the best.



Multi-Language Manual QR CODE

Please scan the QR code to access the manual in multiple languages.

WARNING

1. Please make sure to turn off the power before starting the installation.
2. Installation must be performed by a qualified electrician.



- "Danger" indicates a hazardous situation which, if not avoided, will result in death or serious injury.
- "Warning" indicates a hazardous situation which, if not avoided, could result in death or serious injury.
- "Caution" indicates a hazardous situation which, if not avoided, could result in minor or moderate injury..
- Danger to life due to high voltages in the inverter!
- All work must be carried out by qualified electrician.
- The appliance is not to be used by children or persons with reduced physical sensory or mental capabilities, or lack of experience and knowledge, unless they have been given supervision or instruction.
- Children should be supervised to ensure that they do not play with the appliance.
- Danger of burn injuries due to hot enclosure parts!
- During operation, the upper lid of the enclosure and the enclosure body may become hot.
- Only touch the lower enclosure lid during operation.
- Possible damage to health as a result of the effects of radiation!
- Do not stay closer than 20 cm to inverter for any length of time.
- Ensure input DC voltage \leq Max. DC voltage .Over voltage may cause permanent damage to inverter or other losses, which will not be included in warranty!
- Authorized service personnel must disconnect both AC and DC power from inverter before attempting any maintenance or cleaning or working on any circuits connected to inverter.
- Do not operate the in verter when the device is running
- Over-voltage protection with surge arresters should be provided when the PV power system is installed.
- The grid connected inverter is not fitted with SPDs in both PV input side and MAINS side.
- High leakage current! Earth connection essential before connecting supply.

Note!



- "Note" provides tips that are valuable for the optimal operation of our product.
 - Grounding the PV generator.
 - Comply with the local requirements for grounding the PV modules and the PV generator. It is recommends connecting the generator frame and other electrically conductive surfaces in a manner which ensures continuous conduction and ground these in order to have optimal protection of system and persons.
-

-
- Prior to the application, please read this section carefully to ensure correct and safe application. Please keep the user manual properly.
 - Accessories only together with the inverter shipment are recommended here. Otherwise may result in a risk of fire, electric shock, or injury to person.
 - Make sure that existing wiring is in good condition and that wire is not undersized.
 - Do not disassemble any parts of inverter which are not mentioned in installation guide. It contains no user-serviceable parts. See Warranty for instructions on obtaining service. Attempting to service the inverter yourself may result in a risk of electric shock or fire and will void your warranty.
 - Keep away from flammable, explosive materials to avoid fire disaster. The installation place should be away from humid or corrosive substance.
 - Authorized service personnel must use insulated tools when installing or working with this equipment.
 - PV modules shall have an IEC 61730 class A rating.
 - Never touch either the positive or negative pole of PV connecting device.
 - Strictly prohibit touching both of them at the same time.
 - The unit contains capacitors that remain charged to a potentially lethal voltage after the MAINS , battery and PV supply has been disconnected.
 - Hazardous voltage will present for up to 5 minutes after disconnection from power supply.
 - CAUTION-RISK of electric shock from energy stored in capacitor, Never operate on the inverter couplers, the MAINS cables, Battery cables, PV cables or the PV generator when power is applied. After switching off the PV , battery and Mains, always wait for 5minutes to let the intermediate circuit capacitors discharge before unplugging DC ,battery inplug and MAINS couplers.
 - When accessing the internal circuit of inverter, it is very important to wait 5 minutes before operating the power circuit or demounting the electrolyte capacitors inside the device. Do not open the device before hand since the capacitors require time sufficiently discharge!
 - Measure the voltage between terminals UDC+ and UDC- with a multi-meter(impedance at least 1Mohm) to ensure that the device is discharged before beginning work (35VDC) inside the device.

Surge protection devices (SPDs) for PV installation











- Lightning will cause a damage either from a direct strike or from surges due to a nearby strike.
 - Induced surges are the most likely cause of lightning damage in majority of installations, especially in rural areas where electricity is usually provided by long overhead lines. Surge may be included on both the PV array conduction and the AC cables leading to the building.
 - Specialists in lightning protection should be consulted during the end use application. Using appropriate external lightning protection, the effect of a direct lightning strike into a building can be mitigated in a controlled way, and the lightning current can be discharged into the ground.
 - Installation of SPDs to protect the inverter against mechanical damage and excessive stress include a surge arrester in case of a building with external lightning protection system (LPS) when separation distance is kept.
 - To protect the DC system, surge suppression device (SPD type2) should be fitted at the inverter end of the DC cabling and at the array located between the inverter and the PV generator, if the voltage protection level (VP) of the surge arresters is greater than 1100V, an additional SPD type 3 required for surge protection for electrical devices.
 - To protect the AC system, surge suppression devices (SPD type2) should be fitted at the main incoming point of AC supply (at the consumer's cutout), located between the inverter and the meter/distribution system; SPD (test impulse D1) for signal line according I to EN 61632-1.
 - All DC cables should be installed to provide as short a run as possible, and positive and negative cables of the string or main DC supply should be bundled together.
-

-
- Avoiding the creation of loops in the system.
 - Spark gap devices are not suitable to be used in DC circuits once conducting, they won't stop conducting until the voltage across their terminals is typically more than 30 volts.
 - Anti-Islanding Effect Islanding effect is a special phenomenon that grid-connected PV system still supply power to the nearby grid when the voltage loss is happened in the power system. It is dangerous for maintenance personnel and the public. X1-Hybrid series inverter provide Active Frequency Drift(AFD) to prevent islanding effect.

PE Connection and Leakage Current

- The end-use application shall monitor the protective conductor by residual current operated protective device (RCD) with rated fault current $I_{fn} \leq 240\text{mA}$ which automatically disconnects the device in case of a fault. The device is intended to connect to a PV generator with a capacitance limit of approx 700nf.
 - Incorrect grounding can cause physical injury, death or equipment malfunction and increase electromagnetic.
 - Make sure that grounding conductor is adequately sized as required by safety regulations.
 - Do not connect the ground terminals of the unit in series in case of a multiple installation. This product can cause current with a d.c component, Where a residual current operated protective (RCD) or monitoring (RCM) device is used for protection in case of direct or indirect contact, only an RCD or RCM of type B is allowed on the supply side of this product. For United Kingdom
 - The installation that connects the equipment to the supply terminals shall comply with the requirements of BS 7671.
 - Electrical installation of PV system shall comply with requirements of BS 7671 and IEC 60364-7-712.
 - No protection settings can be altered.
 - User shall ensure that equipment is so installed, designed and operated to maintain at all times compliance with the requirements of ESQCR22(1)(a). For Australia and New Zealand
 - Electrical installation and maintenance shall be conducted by licensed electrician and shall comply with Australia National Wiring Rules. Battery Safety Instructions VT series inverter should be worked with high voltage battery, for the specific parameters such as battery type, nominal voltage and nominal capacity etc., please refer to section 4.3. As accumulator batteries may contain potential electric shock and short-circuit current danger, to avoid accidents that might be thus resulted, the following warnings should be observed during battery replacement:
 - 1: Do not wear watches, rings or similar metallic items.
 - 2: Use insulated tools.
 - 3: Put on rubber shoes and gloves.
 - 4: Do not place metallic tools and similar metallic parts on the batteries.
 - 5: Switch off load connected to the batteries before dismantling battery connection terminals.
 - 6: Only personal with proper expertise can carry out the maintenance of accumulator batteries.
-

EXPLANATION OF SYMBOL

Symbol	Explanation
	CE mark. The inverter complies with the requirements of the applicable CE guidelines.
	TUV certified.
	RCM remark.
	SAA certification.
	Beware of hot surface. The inverter can become hot during operation. Avoid contact during operation.
	Danger of high voltages. Danger to life due to high voltages in the inverter!
	Danger. Risk of electric shock!
	Observe enclosed documentation.
	The inverter can not be disposed together with the household waste. Disposal information can be found in the enclosed documentation.
	Do not operate this inverter until it is isolated from battery, mains and on-site PV generation suppliers.
	Danger to life due to high voltage. There is residual voltage existing in the inverter after powering off, which needs 5 min to discharge. <ul style="list-style-type: none"> • Wait 5 min before you open the upper lid or the DC lid.

This chapter follows the requirements of the European low voltage directives, which contains the safety instructions and conditions of acceptability for the end user system, which you must follow when installing, operating and servicing the unit. If ignored, physical injury or death may follow, or damage may occur to the unit. Read this before you work on the unit. If you are unable to understand the dangers, warnings, cautions or instructions, please contact an authorized service dealer before installing. Operating and servicing the unit. The Grid connected inverter meets the requirement stipulated in Low Voltage Directive (LVD) 2014/35/EU and Electromagnetic Compatibility (EMC) Directive 2014/30/EU. The unit is based on: EN 62109-1:2010;EN 62109-2:2011;IEC 62109-1(ed.1); IEC62109-2(ed.1);EN 61000-6-3:2007+A:2011;EN 61000-6-1:2007;EN 61000-6-2:2005. In case of installation in PV system, startup of the unit (i.e. start of designated operation) is prohibited until it is determined that the full system meets the requirements stipulated in EC Directive (2014/35/EU,2014/30/EU, etc.),The grid connected inverter leave the factory completely connecting device and ready for connection to the mains and PV supply ,the unit shall be installed in accordance with national wiring regulations. Compliance with safety regulations depends upon installing and configuring system correctly, including using the specified wires. The system must be installed only by professional assemblers who are familiar with requirements for safety and EMC. The assembler is responsible for ensuring that the end system complies with all the relevant laws in the country where it is to be used. The individual subassembly of the system shall be interconnected by means of the wiring methods outlined in national/inter national such as the national electric code (NFPA) No.70 or VDE regulation 0107.

INTRODUCTION

The inverter can be used to optimize self consumption, store in the battery for future use or feed in to public grid. Work mode depends on PV energy and user's preference. It can provide power for emergency use during the grid lost by using the energy from battery and inverter(generated from PV).

System Diagram

VT series is designed with two EPS versions for customer to choose based on the local rules. E Version applies to the wiring rules that requires the Live line and Neutral line of EPS must be disconnected with the Live line and Neutral line of grid (applies to most countries).

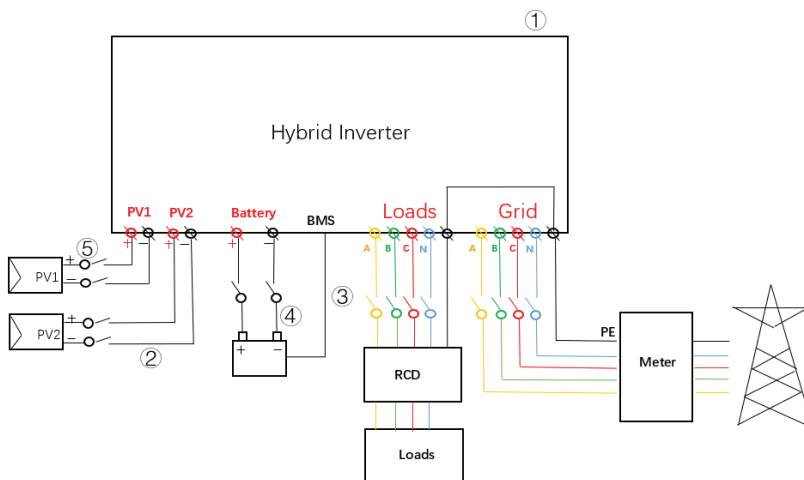

I Version applies to the wiring rules that requires Neutral line of alternative supply must NOT be isolated or switched (applies to wiring rules AS/NZS_3000:2012 for Australia and New Zealand).

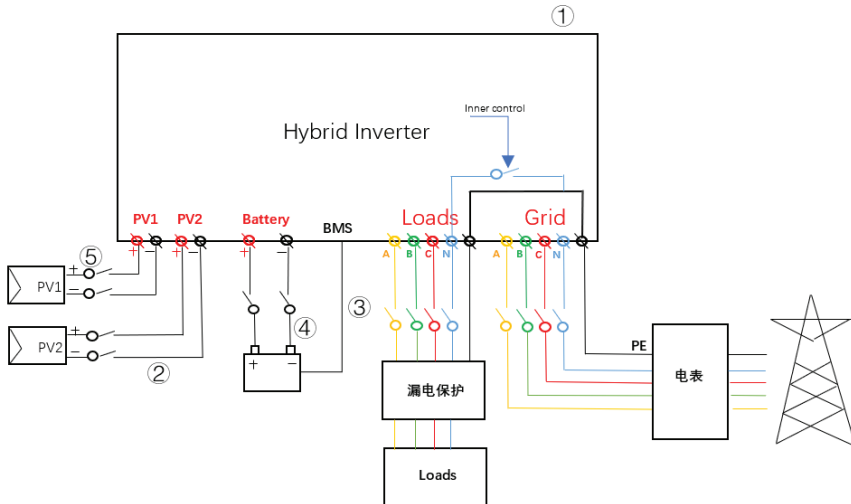

Note!



- Please control the home loads, and make sure it's within the "EPS output rating" under EPS mode, otherwise the inverter will shutdown with an "overload fault" warning.
- Please confirm with the mains grid operator whether there is any special regulations for grid connection.

Work Modes

Inverter provides multiple work modes based on different requirements.

Work modes: Self-use (with PV Power)

Priority: load>battery>grid
 This mode applies the area that has low feed-in tariff and high energy price. The power generated from PV will be used to supply the local loads firstly, then to charge the battery. The redundant power will export to the public grid.

Work modes: Self-use (without PV Power)

When no PV supplied, battery will discharge for local loads firstly, and grid will supply power when the battery capacity is not enough

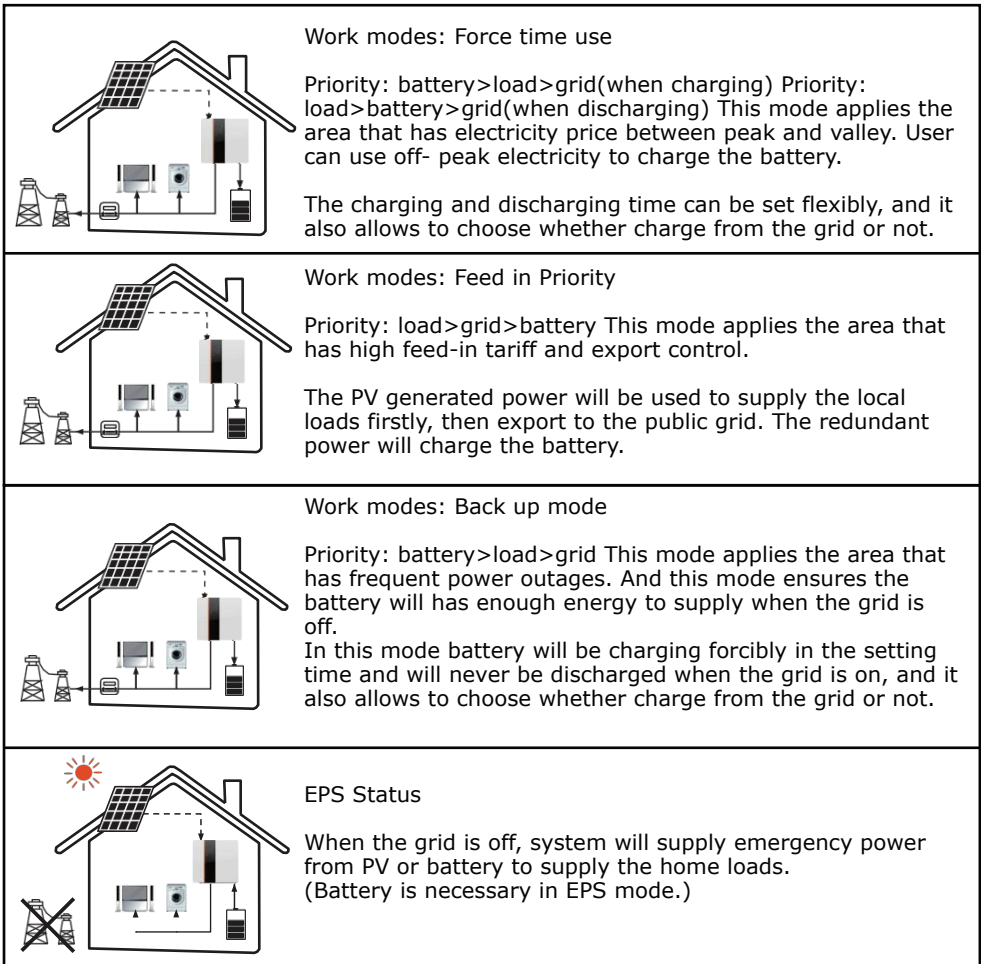

DIMENSION

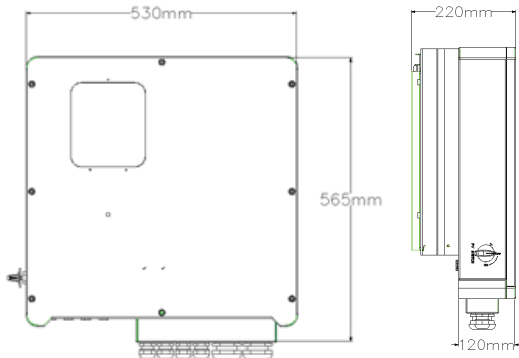

TERMINAL OF PV INVERTER

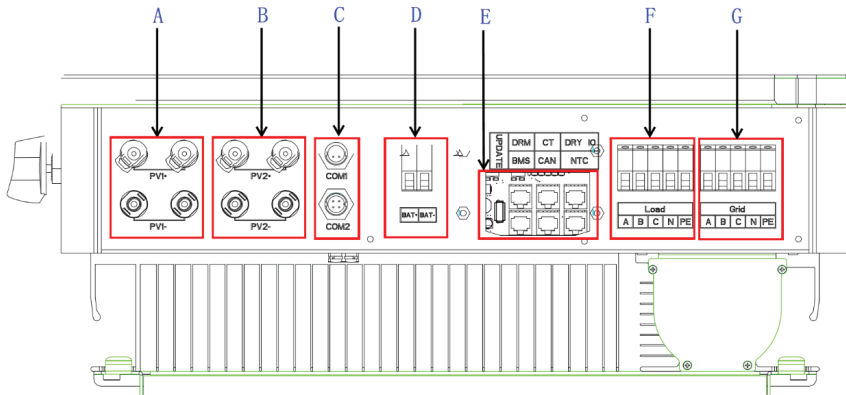

Object	Description
A	PV1+ P V1-
B	PV2+ P V2-
C	COM1: WIFI COM2: Reserved
D	BAT+ battery+, BAT- battery+
E	MS : battery manage system communication
	DRM demand respond mode
	Dry IO: dry contact for peripheral
	CAN : upper computer communication (EMS)
	NTC : Reserved temperature sensor
	CT: Power meter
F	EPS out
G	Grid out

TECHNICAL DATA

1. Battery interface parameters (apply to version E, I)

MODEL	VT-6608303
Battery voltage range V	125~600
Maximum battery current A	50
Maximum charge and discharge power W	8800

Photovoltaic interface parameters (apply to version E, I)

Model	VT-6608303
Maximum DC voltage V	1000
MPPT voltage range A	125~850
Starting voltage V	125
Maximum charge and discharge power W	13/13
Maximum DC input power W	1140
Maximum short circuit current	15
MPPT tracker	2
Strings of per MPPT tracker	1/1

Ac side on grid parameters (apply to version E, I)

Model	VT-6608303
AC output power (VA)	8000
Maximum Input power (VA)	8800
Maximum output current (A)	12.7
Max input Current (A)	12.7
Rated Output Voltage (V)	400V 3W+N+PE
Rated frequency (Hz)	50Hz/60Hz
Current harmonic distortion (Rated Power)	< 3%
Power factor	~1 (0.8~0.8)

Mechanical parameter (apply to version E, I)

Model	VT-6608303
Dimension(W/H/D)	(520*550*180)
Weight (Kg)	23

Ac side off grid parameters (apply to version E,I)

Model	VT-6608303
Rated output power (VA)	8000
Rated Output Voltage (V)	400V,3W+N+PE
Rated frequency (Hz)	50Hz/60Hz
THDI (Rated Power)	< 3%
Maximum efficiency	97.90%
European efficiency	97.20%
MPPT efficiency	99.50%
Battery charging and discharging efficiency	97.50%

IGMP Interface Parameters (apply to version E, I)

Model	VT-6608303
HIMI	LED APP
BMS	RS485, CAN
EMS	RS485
POWER METER	RS485
OTHER COMMUNICATION	WIFI or WAN

Basic Parameters (apply to version E, I)

Model	VT-6608303
IP Rating	IP65
Operation Temperature Range	-25~60°C derating at 45°C
Relative Humidity	0~100%
Attitude	derating>2000m
Cooling Mode	Natural
Noise Level	≤30 dB
Installation	Wall-mounted

Safety Protection apply to version E, I)

Model	VT-6608303
Photovoltaic input connection reverse protection	YES
Battery input connection reverse protection	YES
Insulation monitor	YES
Residual current detection	YES
PV Input overvoltage over power	YES
The battery input overvoltage overpower	YES
Ac output input overvoltage overpower	YES
Over-temperature protection	YES
Ripple current over limit	YES
Reference power failure protection	YES

INSTALLATION

Check for Physical Damage Make sure the inverter is intact during transportation. If there is any visible damage, such as cracks, please contact your dealer immediately.

PACKING LIST

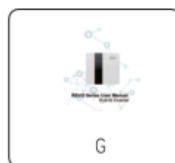
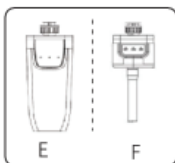
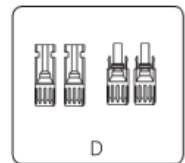
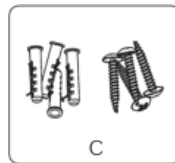
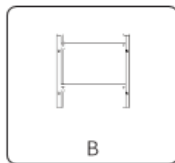
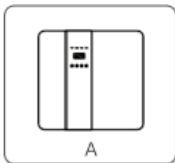

PACKAGING DESCRIPTION

Object	Description
A	Inverter
B	Bracket
C	Expansion screws and pan-head screws
D	PV connectors (2*positive, 2*negative)
E	WIFI module (optional)
F	GPRS module (optional)
G	User manual

Mounting

Installation Precaution inverter is designed for outdoor installation (IP 65).
Make sure the installation site meets the following conditions:

- Not in direct sunlight.
- Not in areas where highly flammable materials are stored.
- Not in potential explosive areas. Not in the cool air directly.
- Not near the television antenna or antenna cable.
- Not higher than altitude of about 2000m above sea level.
- Not in environment of precipitation or humidity (>95%).
- Under good ventilation condition.
- The ambient temperature in the range of -20°C to +60°C.
- The slope of the wall should be within $\pm 5^\circ$.
- The wall hanging the inverter should meet conditions below:
 - 1.solid brick/concrete, or strength equivalent mounting surface;
 - 2.Inverter must be supported or strengthened if the wall's strength isn't enough (such as wooden wall, the wall covered by thick layer of decoration)

Please AVOIDE direct sunlight, rain exposure, snow laying up during installation and operation.

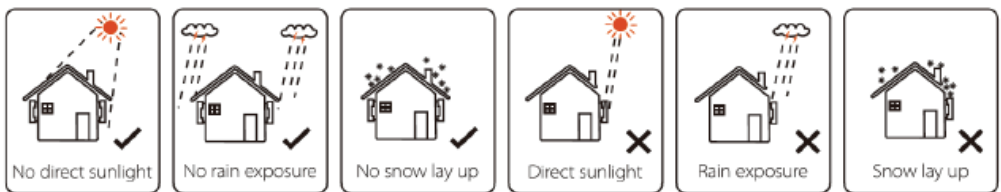

SPACE REQUIREMENT

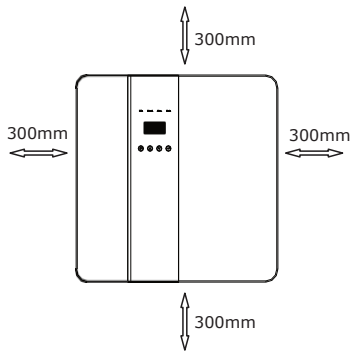

Table Available Space Size	
Position	Min.size
Left	300mm
Right	300mm
Top	300mm
Bottom	300mm
Front	300mm

TOOLS REQUIRED FOR INSTALLATION

Installation tools: crimping pliers for binding post and RJ45, screwdriver, manual wrench etc



Step 1: Screw the wall bracket on the wall

1. Place the bracket on the wall and mark down the position of the 4 holes.
2. Drill holes with driller, make sure the holes are deep enough (at least 60mm) to support the inverter.
3. Install the expansion tubes in the holes, and tighten them. Then install the wall bracket with the expansion screws.

Step 2: Place the inverter on the wall mounted bracket by holding the handle on the side.

Step 3: Tighten the fixing screws on both sides of the inverter.

Step 4: If necessary, customer can install an anti-theft lock on the left-bottom of the inverter.

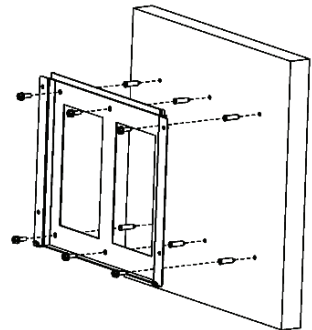
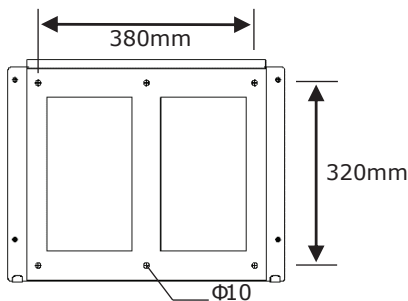

STEP 1

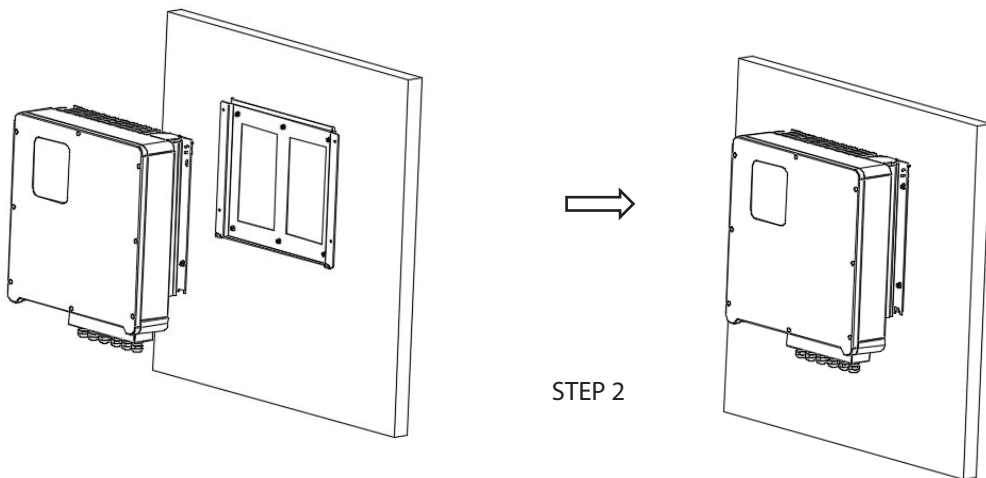

WIRING CONNECTION

1.PV connection

Select PV modules with excellent function and reliable quality. Open-circuit voltage of module arrays connected in series should be <Max. DC input voltage; operating voltage should be conformed to MPPT voltage range.

Max.DC Voltage Limitation

Model	VT-6608303
Max. DC Voltage (V)	1000
MPPT Voltage Range (V)	125-500



Warning!

PV module voltage is very high, which already achieve dangerous voltage range, please comply with electric safety rules when connecting.
Please do not make PV positive or negative ground!



Note!

The following requirements of PV modules need to be applied for each input area;
Please do not make PV positive or negative ground!
In order to save cable and reduce the DC loss, we suggest to install the inverter near PV modules.

Note!

PV connection mode below is NOT allowed!

X

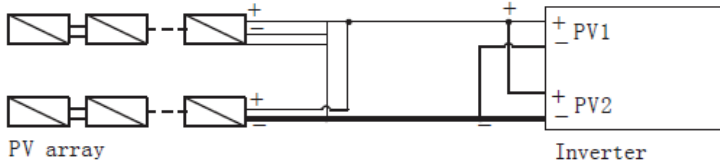

CONNECTION STEPS:

Step 1. Checking PV module.

1. Use multimeter to measure module array voltage.
2. Check the PV+ and PV- from the PV string combiner box correctly.
3. Please make sure the impedance between the positive pole and negative pole of PV to earth should be $M\Omega$ level.

Step 2. Separating the DC connector.

Step 3. Wiring.

1. Choose the 12 AWG wire to connect with the cold-pressed terminal.
2. Remove 10mm of insulation from the end of wire.
3. Insert the insulation into pin contact and use crimping plier to clamp it.

Step 4. Insert pin contact through the cable nut to assemble into back of the male or female plug. When you feel or heard a "click" sound the pin contact assembly is seated correctly.

Step 5. Plug the PV connector into the corresponding PV connector on inverter.

Step2

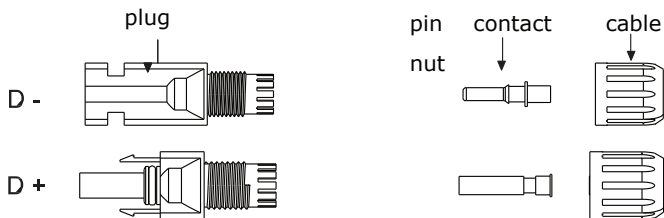

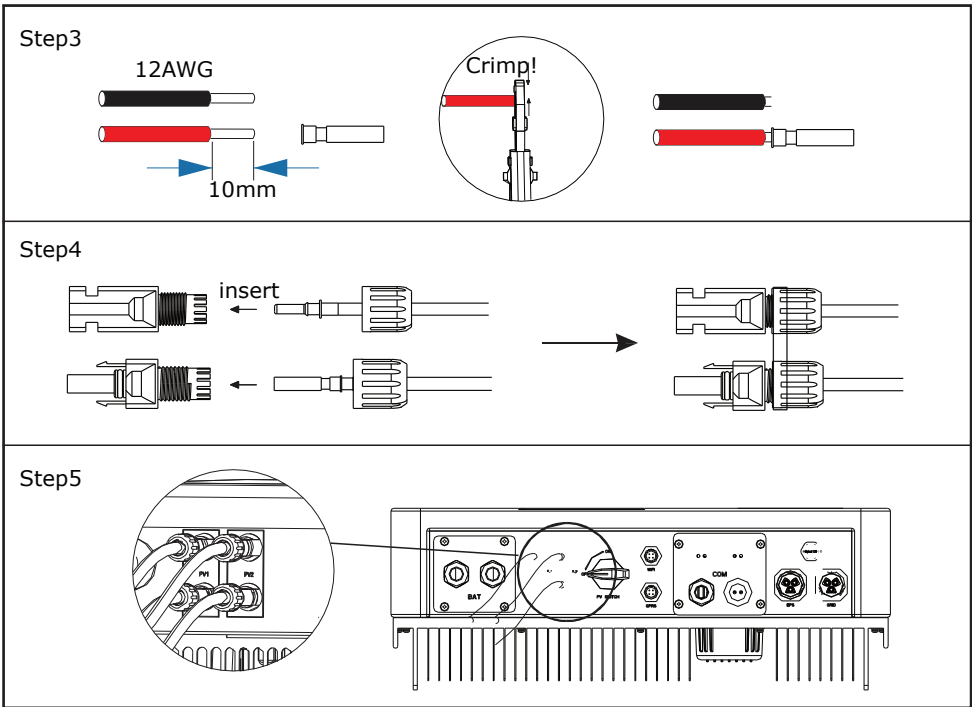

GRID CONNECTION

VT series inverter are designed for single phase grid. Voltage is 220/230/240V, frequency is 50/60Hz. Other technical requests should comply with the requirement of the local public grid.

Table of cable and Micro-breaker recommended

MODEL	VT-6608303
E VERSION CABLE	4-5 mm ²
E VERSION MICRO-BREAKER	20A
I VERSION CABLE	6-8mm ²
I VERSION MICRO-BREAKER	40A

Micro-breaker should be installed between inverter and grid, any load should not be connected with inverter directly.

CONNECTION STEPS

Step 1. Check the grid voltage.

1. Check the grid voltage and compare with the permissive voltage range (Please refer to technical data).
2. Disconnect the circuit board from all the phases and secure against re-connection.

Step2. Remove the waterproof lid from the grid port on the inverter.

Step3. Make AC wires.

3.1 Choose the appropriate wire (Cable size: refer to Table 4).

3.2 Reserve about 60mm of conductor material sectional area.

3.3 Remove 10mm of insulation from the end of wire.

Step4. Connect the AC connector to the GRID port of the inverter and tighten the screw cap.

Step2

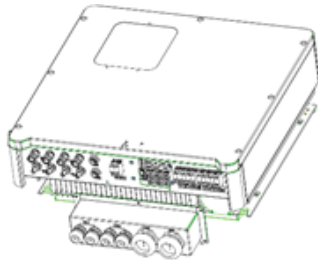

Step3

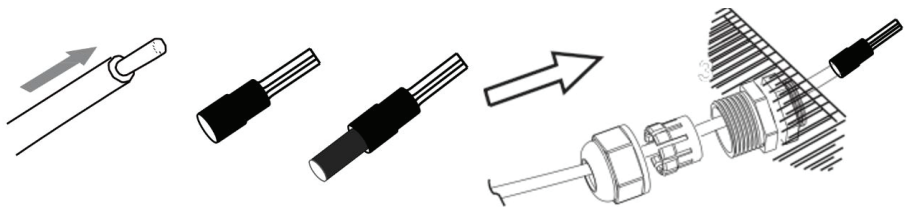

Step4

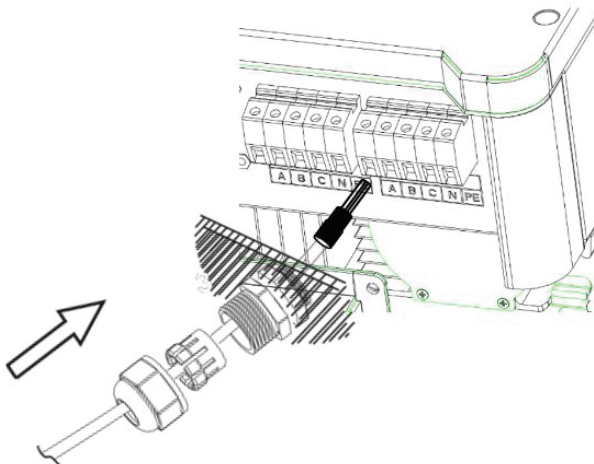

EPS Connection(apply to I Version and E Version only)

Inverter has On and Off grid function, the inverter will deliver output power through AC port when the grid is on, and it will deliver output power through EPS port when the the grid is off.

I Version & E Version

VT series inverter provides two versions for customer to choose based on the local rules. "I Version" means inverter has an build-in changeover switch. This version applies to the wiring rules which requires Neutral line of alternative supply must not be isolated or switched.(applies to wiring rules AS/NZS3000:2014 of Australia and New Zealand.)

"E Version" means inverter needs to install an external changeover device for EPS function. This version applies to the wiring rules which allows Neutral line of alternative supply can be isolated or switched.(applies to most of the countries)

Auto & Manual

EPS function can be achieved automatically or manually according to user's wishes. For "I Version" inverter, EPS function can only be triggered automatically. For "E Version" inverter, EPS function can be triggered either automatically or manually according to user's preference. If user wants to use this function manually, it will need to be installed an external switch. Please refer to specific wiring diagram below. For automatical solution, please contact our sales.

I Version Auto

Do not require for Changeover Switch

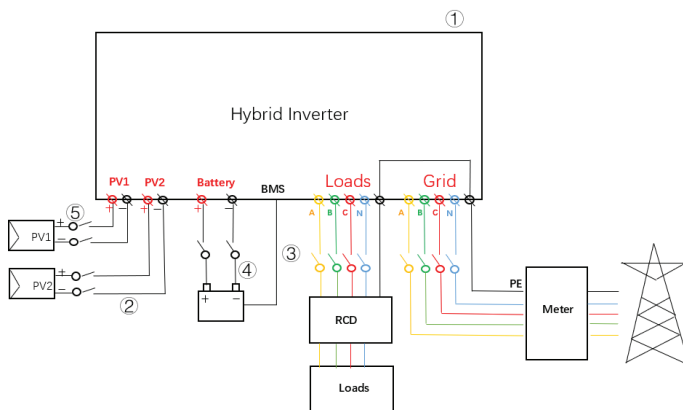

E Version Auto

Required for Changeover Switch

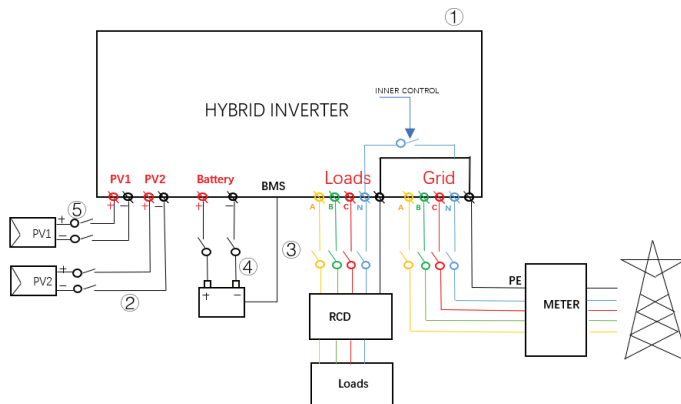



Note!

- In case of discrepancies between wiring mode of local policy and the operation guide above, especially for the wiring of neutral line,

CONNECTION STEPS:

Step1. Make EPS wires.

- 3.1 Choose the appropriate wire (cable size: refer to picture below).
- 3.2 Reserve about 60mm of conductor material sectional area.
- 3.3 Remove 10mm of insulation from the end of wire.

Step2. Connect the AC connector to the EPS port of the inverter with a slotted screwdriver

Table of cable and Micro-breaker recommended

CABLE AND MICRO-BREAKER RECOMMENDED

MODEL	VT-6608303
EPS Cable	4-5 mm ²
EPS Breaker	20A

Step1

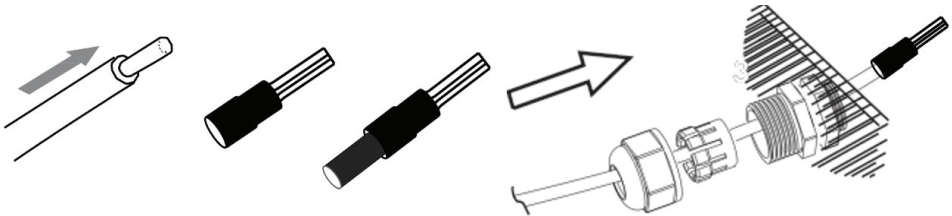

Step1

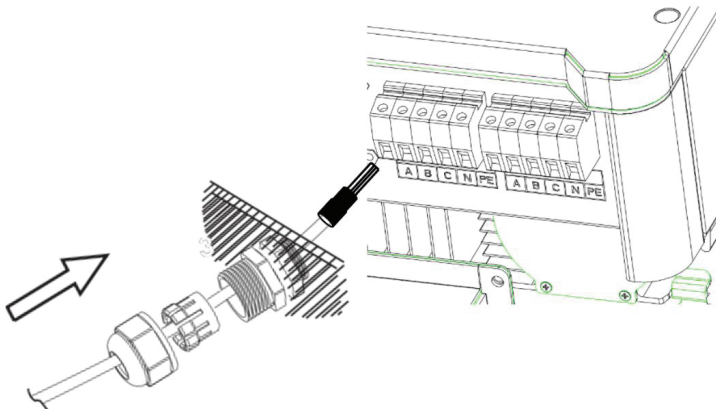











WARNING!

- Make sure the EPS load power rating is within EPS output rating, otherwise the inverter will shutdown with an "over load" warning.
- When an "over load" is appeared, adjust the load power to make sure it is within the EPS output power range, then turn the inverter back on.

Below table shows some common feasible loads for you reference.

Type	Power		Common equipment	Example		
	Start	Rated		Equipment	Start	Rated
Resistive load	R 1	R 1	  Incandescent lamp TV	 100W Incandescent lamp	100VA (W)	100VA (W)
Capacitive load	R 2	R 1.5	 Fluorescent lamp	 40W Fluorescent lamp	80VA (W)	60VA (W)
Inductive load	R 3~5	R 2	  Fan Fridge	 150W Fridge	450-750VA (W)	300VA (W)

BATTERY CONNECTION

- Charging & discharging system of inverter is designed for high-voltage lithium battery. Before choosing battery, please note the maximum voltage of battery can not exceed 59V and the rated voltage of battery can not exceed 48V, and the battery communication should be compatible with VT series inverter.
- Battery breaker Before connecting to battery, please install a nonpolarized DC breaker to make sure inverter can be securely disconnected during maintenance.

MODEL	VT-6608303
VOLTAGE	Nominal voltage of DC breaker should be larger than maximum voltage of battery.
CURRENT [A]	80A

BATTERY CONNECTION DIAGRAM

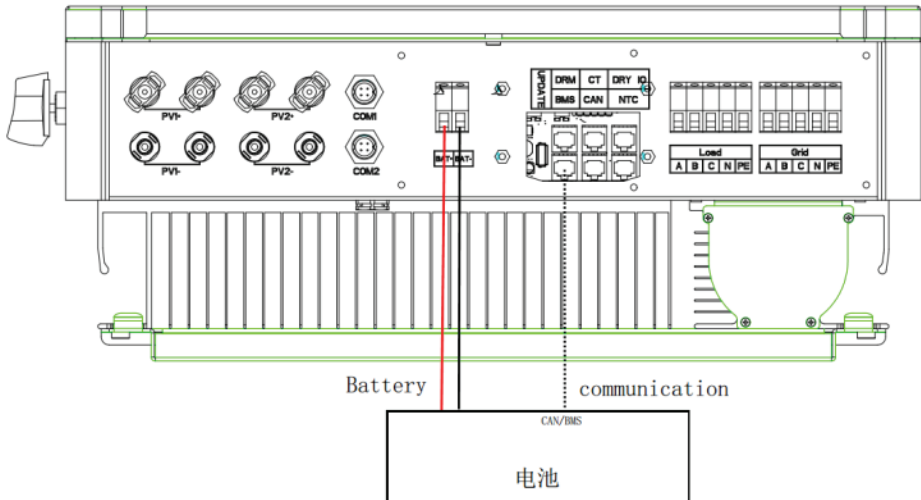

BMS PIN DEFINITION

Communication interface between inverter and battery is RS485 or CAN with a RJ45 connector.

	PIN	1	2	3	4	5	6	7	8
CAN	Definition	X	X	X	BMS_CANH	BMS_CANL	X	X	X
Rs485	Definition	X	X	X	X	X	GND	BMS_485A	BMS_485B

When using RS485 protocol, please note that PIN2 must be disconnected.

Note!

The battery communication can only work when the battery BMS is compatible with the inverter.

POWER CONNECTION STEPS:

Step1. Choose the 2 AWG wire and strip the cable to 15mm.

Step2. Select two O-terminals with an aperture of M6.

Step3. Insert the stripping line into the O-terminal and clamp it with a crimping clamp.

Step4. Remove waterproof cover plate.

Step5. Disassemble the waterproof connector and pass the cable through the waterproof connector.

Step6. Connect the cable to the terminal of the inverter.

Step7. Assemble waterproof connectors and waterproof covers plate.

STEP1,2,3



STEP4

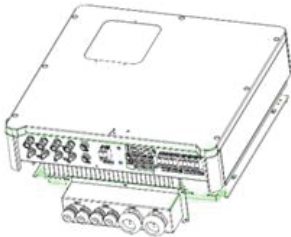

STEP5

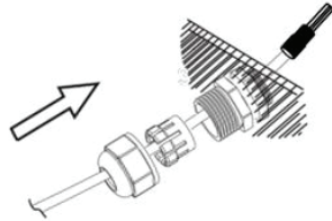

STEP6, 7

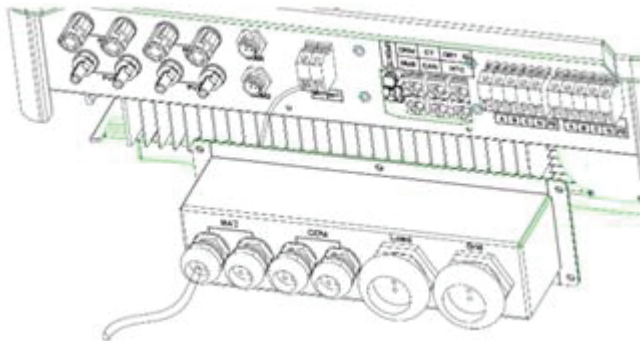

METER CONNECTION

Meter is used for monitoring the power usage for entire house, at the meantime, inverter will also need the data from Meter to achieve the Export Control Function.



Note!

It is necessary to connect meter to inverter otherwise inverter will shutdown with a "Meter fault" alert. The meter communication only works when meter is compatible with the inverter.

Meter connection diagram

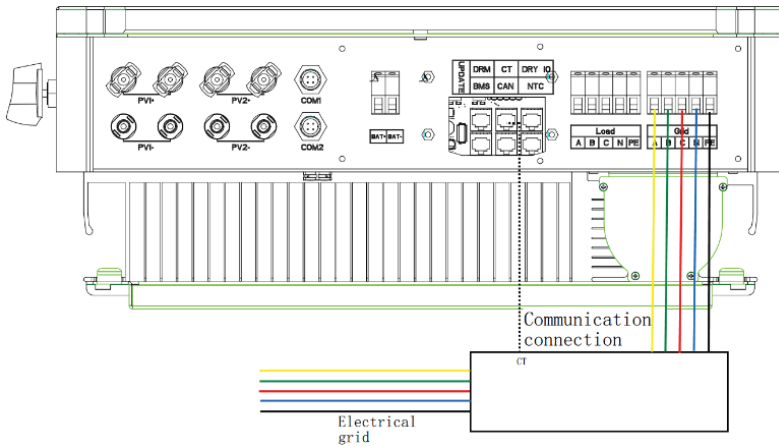

Meter PIN Definition Communication interface between inverter and meter is RS485 with a RJ45 connector.

1	2	3	4	5	6	7	8
IGRID_AP_I	IGRID_AN_I	IGRID_BN_I	IGRID_CP_I	IGRID_CN_I	IGRID_BP_I	RS485_A	RS485_B

Please refer to BMS connection steps (page32) for Meter connection. Please kindly noted the PIN definition and port position will be slightly different.

- Step1. Disassembly of waterproof connectors and waterproof covers.
- Step2. Prepare a communication cable(without sheath) and pass the cable through the waterproof connector.
- Step3. Insert one Rj45 side of the cable into Meter port inside of inverter and the other side into BMS-485port of the meter.
- Step4. Assemble waterproof connectors and waterproof covers plate.

Step 1, 2

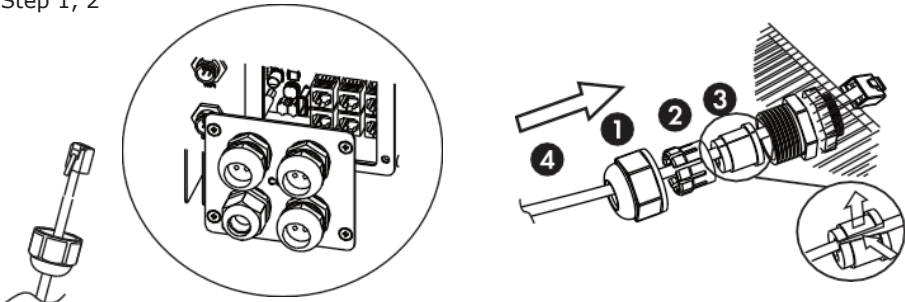

The seal is used for waterproof. Please make sure it has been kept back.

Step 3

DRM	CT	Dry contact
BMS-485 BMS-CAN	Parallel	NTC

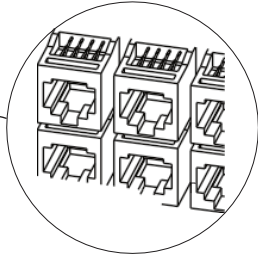

Step 4

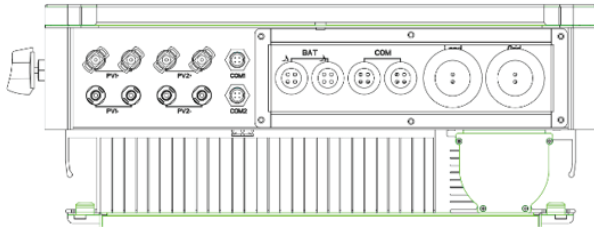

DRM CONNECTION

DRM is provided to support several demand response modes by emitting control signals as below.

Note: Only PIN6(DRM0) is available now, and other PIN functions are being developed.



1	2	3	4	5	6	7	8
DRM1/5	DRM2/6	DRM3/7	DRM4/8	+5V	DRM0	GND	GND

DRM CONNECTION STEPS

Please refer to BMS connection steps (page32) for DRM connection. Please kindly noted the PIN definition and port position will be slightly different.

Step 1, 2

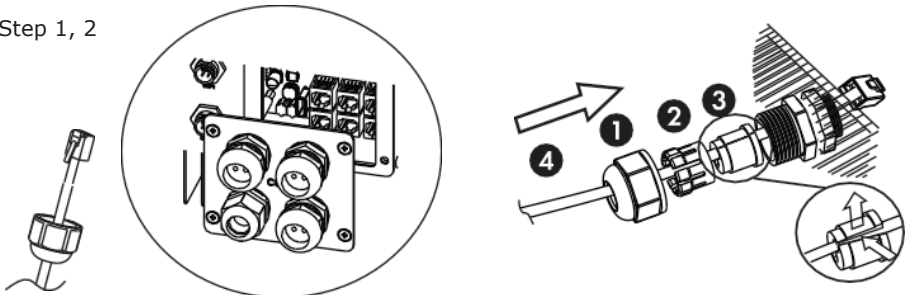

The seal is used for waterproof. Please make sure it has been kept back.

Step 3

DRM	CT	Dry contact
BMS-485 BMS-CAN	Parallel	NTC

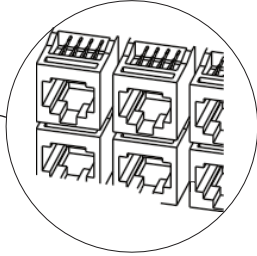

Step 4

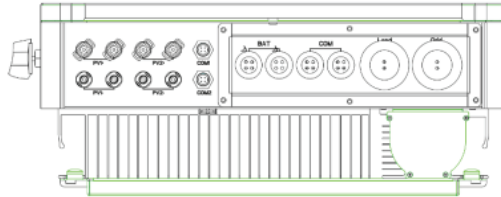

WiFi CONNECTION(OPTIONAL)

Inverter provides a WiFi port which can collect data from inverter and transmit it to monitoring-website by WiFi.(Purchase the product from supplier if needed)

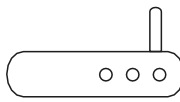
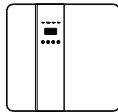

Router



WiFi CONNECTION STEPS

Step1. Plug Wifi into "WiFi" port at the bottom of the inverter.

Step2. Build the connection between the inverter and router.

Step3. Create a user account online.

(Please check the WiFi user manual for more details).

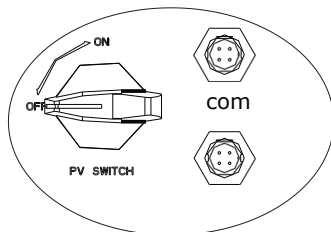

Please connect to the port above

GPRS CONNECTION(OPTIONAL)

Inverter provides a GPRS(radio frequency) interface which control the switch time of a designated load via an external Smart Plug (purchase the product from supplier if needed.) so that the load mostly consumes PV energy and incurs the lowest-possible energy costs during operation.

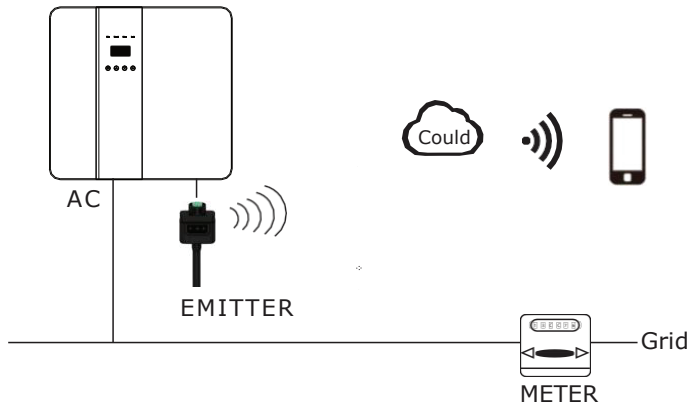

GPRS CONNECTION STEPS

Please refer to the Smart Plug user manual for detailed connection steps.

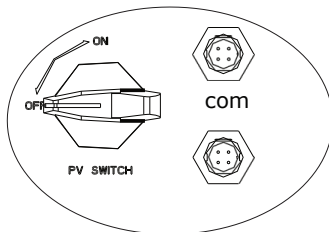

Please connect to the port below

INVERTER MANIPULATION

Start inverter after checking all below steps:

1. Ensure the inverter fixed well on the wall.
 2. Make sure all the DC wirings and AC wirings are completed.
 3. Make sure the meter is connected well.
 4. Make sure the battery is connected well.
 5. Make sure the external EPS contactor is connected well. (if needed)
 6. Turn on the AC switch and EPS switch
 7. Turn on the PV/DC switch and battery switch.
-

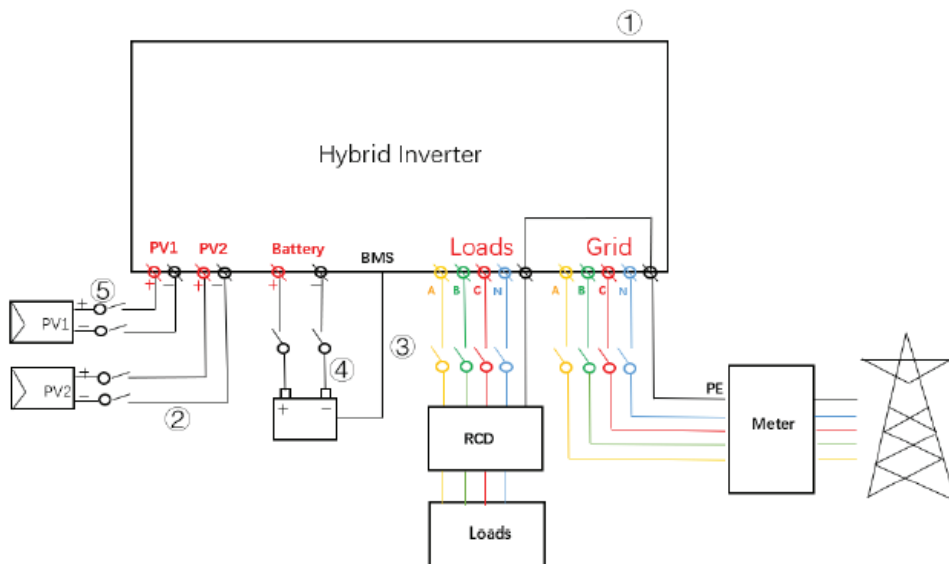

Check the inverter:

Step1. Check the status of indicators and LCD screen. The indicator screen should display the main interface.



Note!

- If the left indicator is not blue please check below the three points:
- All the connections are correct.
 - All the external breakers are switched on.
 - The DC switch on the inverter is in the "ON" position.

Step2. If it is the first time to start up, please follow it. For specific setting, refer to section 8 (Setting).

Step3. Set WiFi according to wifi user manual.

Step4. Operate "Self Test". (applies to Italy only)

Self-test in accordance with CEI 0-21(applies to Italy only)

The self-test is only required for inverters, which are commissioned in Italy. The Italian standard requires that all inverters feeding into the utility grid are equipped with a self-test function in accordance with CEI 0-21. During the self-test, the inverter will consecutively check the protection reaction times and values for overvoltage, under voltage, overfrequency and underfrequency.

SETTING

Control Panel

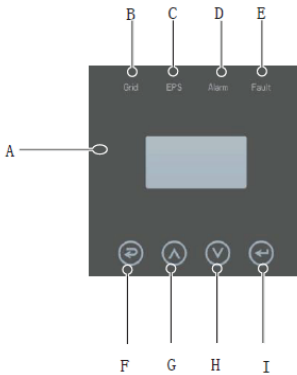

Object	Name	Description
A	LCD SCREEN	Display the information of the inverter.
B	Indicator LED	lit in green: The inverter is in grid mode. Off: The inverter is in not in grid mode.
C		lit in green: The inverter is in off-grid mode. Off: The inverter is in not in off-grid mode.
D		lit in Yellow: The inverter is in Warning. Off: The inverter has no Inverter Warning
E		lit in red: The inverter is in fault status. Off: The inverter has no errors.
F	Function Button	Esc: Return from current interface or function.
G		Up: Move cursor to upside or increase value.
H		Down: Move cursor to downside or decrease value.
I		Enter: Confirm the selection.

Instructions for LED Indicator

	Grid (Green)	EPS (Green)	Alarm (Yellow)	Fault (Red)
Initialization	off	off	off	off
Stand-by	off	off	off	off
Grid mode	on	off	off	off
Off-Grid	off	on	off	off
Bypass of mains	off	on	on	off
Fault	off	off	off	on

INSTRUCTIONS FOR THE USE OF THREE MODES

1. Before selecting the mode, you can set it up according to the local power grid, PV input mode and battery type.

POWER GRID

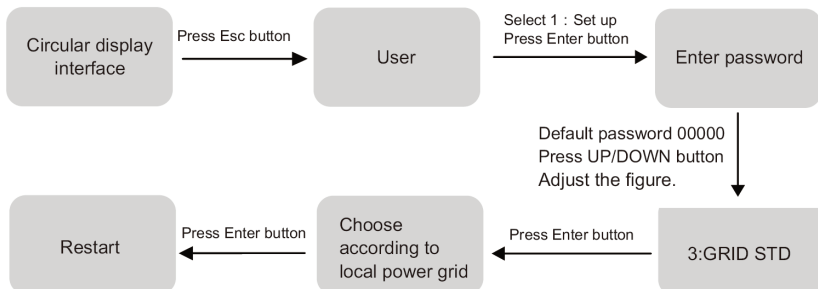

Note: If local grid connection requires reactive power, please set the required reactive power according to the following reference.

SET ACCORDING TO ACTUAL NEEDS

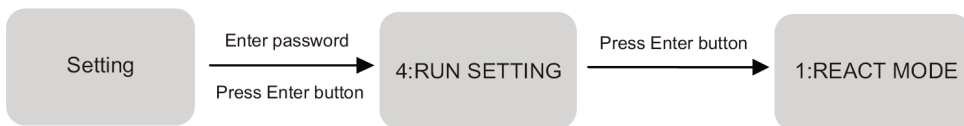

PV INPUT POWER

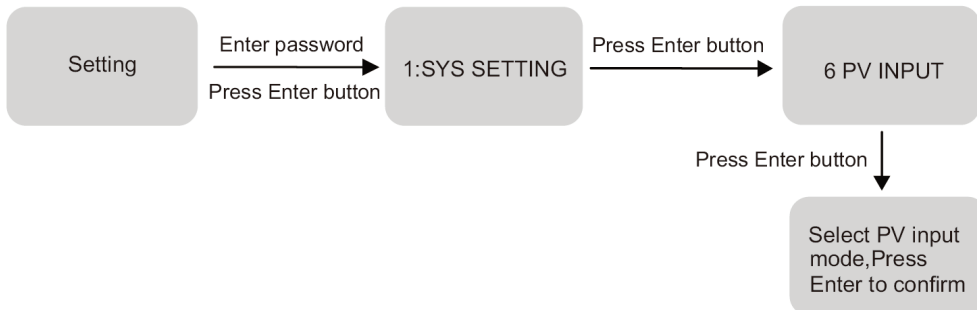

BATTERY PARAMETERS

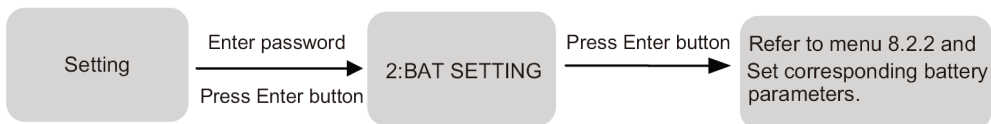

PEAK LOAD SHIFTING

After finishing the setting of Peak load shifting mode the charging and discharging time also need to be set up.

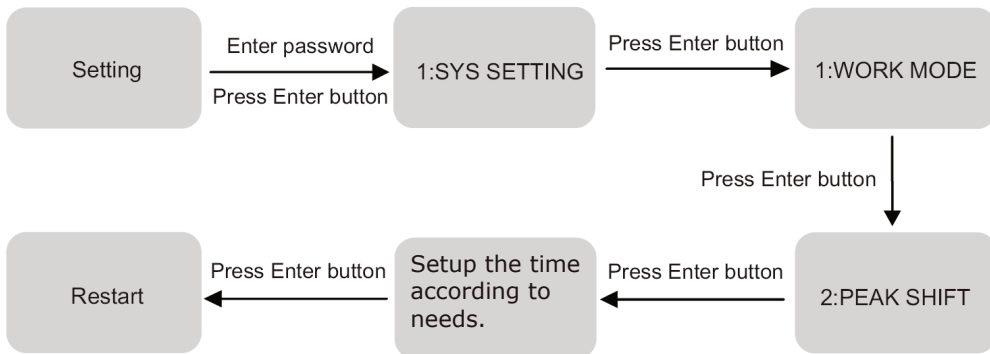

Note: If the time setting is not correct, you need to set the correct time before pressing Enter to exit the interface.

1. Select the corresponding mode based on actual situation
Self-generation and self-consumption(system default mode)

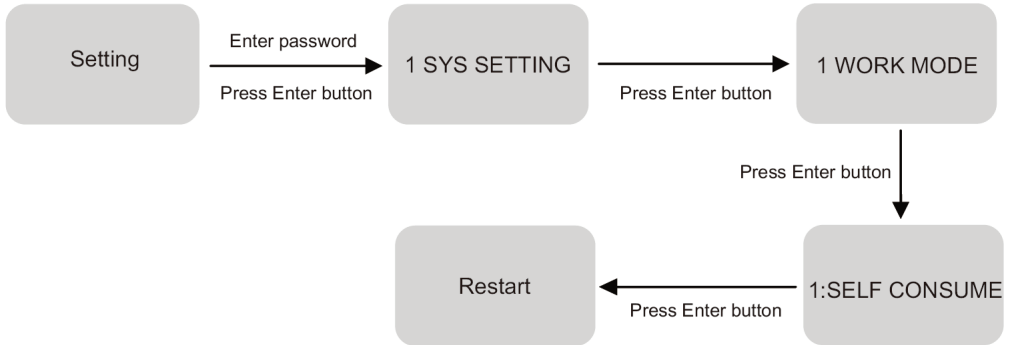

If you want to set up more items, please restart after completing the setup.

BATTERY PRIORITY

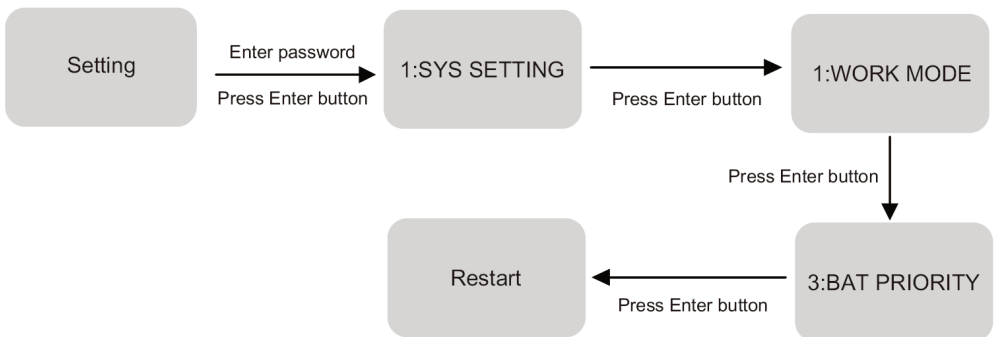

Note: When choosing battery priority mode, the corresponding charging current should be opted for according to the battery type. The system default current is 25A.

LCD OPERATION

8.1. LCD Interface

8.1.1. PV1 input display interface

Interface	
PV1 INPUT	
VOLT: 33.8V	→ PV 1 input real-time voltage
CURR: 0.00A	→ PV 1 input real-time current
POWER: 0W	→ PV 1 input real-time power

8.1.2 PV2 input display interface

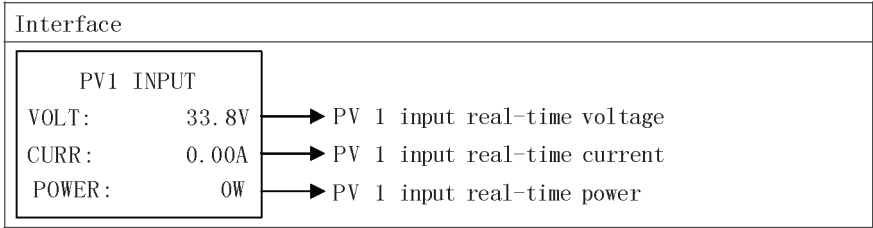

8.1.3 Bus voltage

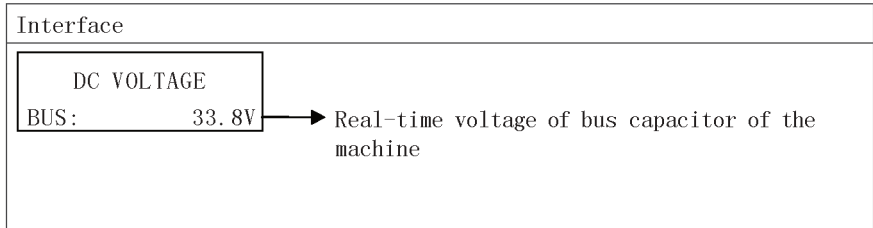

8.1.4 Battery

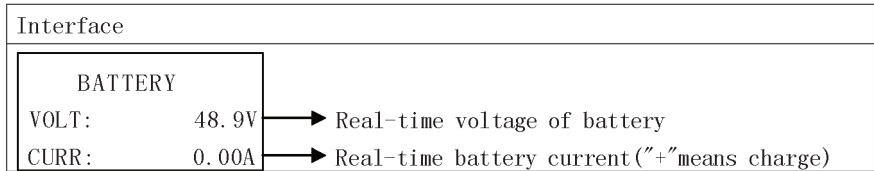

8.1.5 BMS parameters

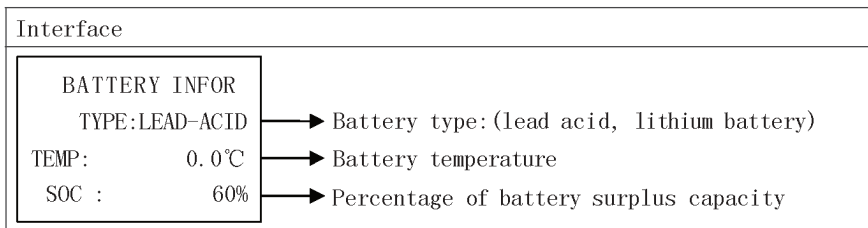

8.1.6 BMS parameters

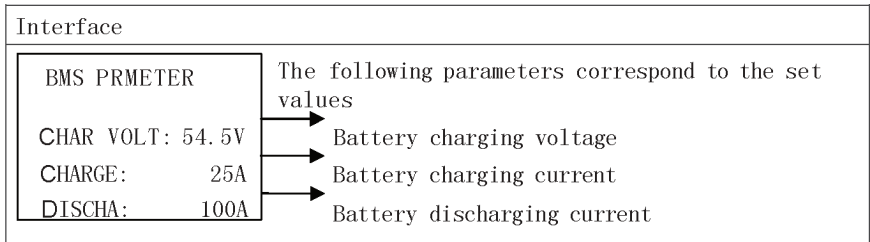

8.1.7 Grid-connected output

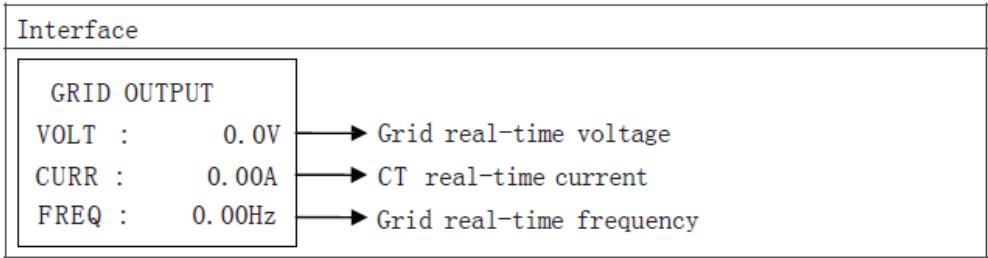

8.1.8 Inverter output

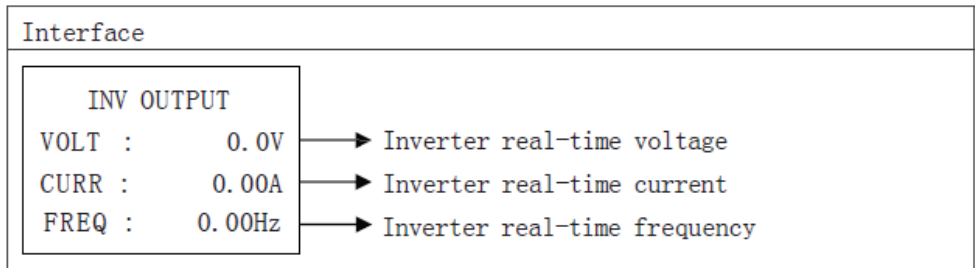

8.1.9 Load

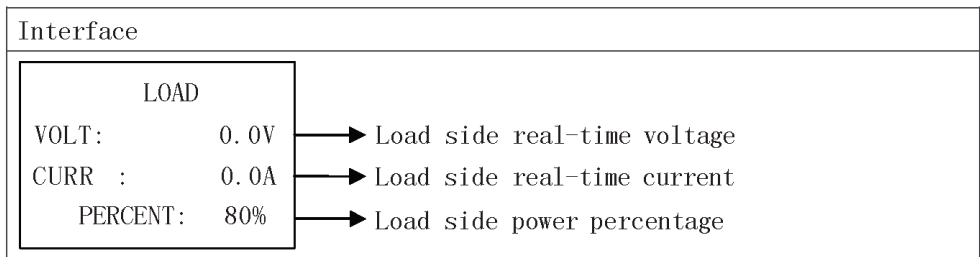

8.1.10 Power

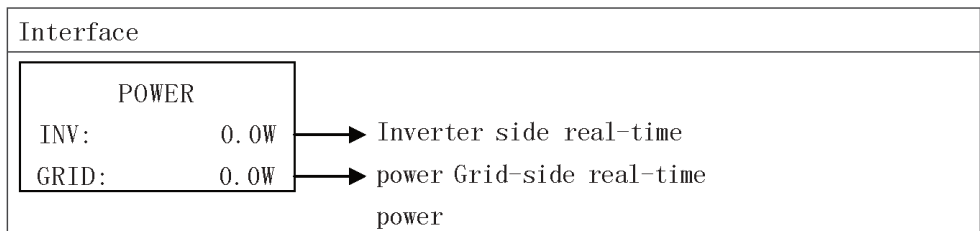

8.1.11 Power

Interface	
<p style="text-align: center;">POWER</p> <p>PV I/P: 0.0W</p> <p>LOAD : 0.0W</p> <p>BAT : 0.0W</p>	<p>→ PV side real-time power</p> <p>→ Load side real-time power</p> <p>→ BAT side real-time power</p>

8.1.12 Temperature

Interface	
<p style="text-align: center;">TEMPERATURE</p> <p>INVER : 0.0°C</p> <p>DCDC : 0.0°C</p> <p>INSIDE : 0.0°C</p>	<p>→ Real-time Temperature of Inverter Side Radiator</p> <p>→ DCDC side radiator real-time temperature</p> <p>→ Internal ambient temperature of the machine</p>

8.1.13 Status information

Interface	Description
<p style="text-align: center;">STATE SYS: STANDBY</p> <p>INV : STANDBY</p> <p>DCDC: STANDBY</p>	<p>System information: Display complete machine status information, Including: Initialization, Standby, PV grid connection, Grid connection of battery, Hybrid power supply, etc.</p> <p>INV: Displays the inverter status information.</p> <p>DCDC: Displays charging and discharging status information .</p>

8.1.14 Error information

Interface	Description
<p style="text-align: center;">ERROR NO.</p> <p>02:BatDisconnect</p>	<p>Numbers represent error codes and text is error information.</p> <p>Refer to Chapter 9 for specific contents.</p> <p>NOTE: When there is a lock mark in the upper right corner of the screen, you cannot turn the page, you need to press Enter to unlock it first.</p>

8.1.15 System setting

Interface	Description
<pre>SYSTEM STATE:SELF CSM GRID : 220/50 PV I/P: PARALL</pre>	<p>State: Setting of the whole machine working mode. Including: self-use, peak cutting and valley filling, battery priority.</p> <p>Grid connection standard: Displays the grid standard actually set.</p> <p>PV input mode: The display value is the setting value of PV input type. Including: independent, parallel, constant voltage.</p>

Press ESC button to enter user setting

8.1.16 User setting

Interface	Description
<pre>USER →1:SETUP 2:INQUIRE 3:STATISTIC</pre>	<p>Press Esc to enter the user settings interface.</p> <p>See chapter 8.2 for more setting details.</p>

Enter the password before setting up the user

Interface	Description
<pre>PASSWORD INPUT: XXXXX</pre>	<p>Enter the password required for setting. The default password is:"00000".</p> <p>Press the Up and Down keys to adjust the number, press the Enter key to move the cursor forward, and press the Esc key move the cursor backward.</p>

8.2. Setting

Interface	Description
<pre> --SETUP-- →1:SYS SETTING 2:BAT SETTING 3:GRID STD 4:RUN SETTING 5:485 ADDRESS 6:BAUD RATE 7:LANGUAGE 8:BACKLIGHT 9:DATE/TIME 10:CLEAR REC 11:PASSWORD 12:MAINTENANCE 13:FCTRY RESET </pre>	<p>This interface is used for various information inquiry options.</p> <p>Press the UP/DOWN button to make the corresponding selection.</p> <p>Press Enter button to enter the selected menu.</p> <p>Press ESC button return to the user interface. (refer to 8.1.16)</p> <p>There are 13 options in total, including system mode, battery parameters, grid standard, operation parameters, 485 address, 485 baud rate, language display, LCD backlight, date/time, clear history, password setting and maintenance, and factory reset.</p>

8.2.1 System setting

Interface	Description
<pre> --SYS SETTING-- →1: WORK MODE 2: EPS ENABLE 3: BAT WAKE-UP 4: REMOTE CTRL 5: START DELAY 6: PV INPUT 7: Anti Reverse </pre>	<p>This interface is used to access system information.</p> <p>Press UP/DOWN button to move corresponding options.</p> <p>Press ENTER to enter the selected menu.</p> <p>Press ESC button to return to the setting interface.</p>

① WORK MODE

Interface	Description
<pre>--WORK MODE-- 1:SELF COMSUME →2:PEAK SHIFT 3:BAT PRIORITY</pre>	<p>This interface is used to select the working mode.</p> <p>Press ESC button return to setting interface.</p> <p>(refer to 8.2.1)</p>

Select the peak clipping and valley filling mode, you also need to set the charge and discharge time.

Time setup

Interface	Description
<pre>CHAG START: 00:00 CHARGE END: 00:00 DISC START: 00:00 DISCHA END: 00:00</pre>	<p>This interface is used to opt for the time of peak load shifting.</p> <p>Press Up/Down button to move the corresponding options.</p> <p>Press Enter to enter the selected menu.</p> <p>Press Esc button to return to the working mode interface.</p>

② EPS ENABLE

Interface	Description
<pre>-- EPS ENABLE -- →1:DISABLE 2:ENABLE</pre>	<p>When the Grid PV is powered off, Enable the battery to supply power to the load, default option is enable.</p>

③ Battery wake up enable

Interface	Description
<pre>— BAT WAKE-UP — →1:DISABLE 2:ENABLE</pre>	Battery wake-up enable setting. The default option is disabled.

④ REMOTE CTRL

Interface	Description
<pre>--REMOTE CTRL-- →1:DISABLE 2:ENABLE</pre>	When you want to remotely control the machine, you need to enable it. Default option is disabled.

⑤ START DELAY

Interface	Description
<pre>--START-UP DELAY-- INPUT:60 UINT:SEC</pre>	The input value ranges from 20 to 300, which varies with different standards.

⑥ PV INPUT

Interface	Description
<pre>--INPUT MODE-- →1: INDEPENDANT 2: PARALLEL 3: CV</pre>	Setup of PV Input mode. The factory setting by default is Independant, When parallel input is set to be stand-alone mode, PV power will be imbalanced.

8.2.2. BAT Setting

Interface	Description
<pre>--BAT SETTING-- 1:BAT TYPE →2:DISC-DEPTH 3:CHARGE-CURR</pre>	<p>This interface is used to select battery parameters.</p> <p>Press UP/DOWN button to move corresponding options;</p> <p>Press ENTER button to enter the selected menu;</p> <p>Press ESC button to return to setting interface.</p>

① Battery type

Interface	Description
<pre>--BAT TYPE- - 1:LEAD- ACID →2: CUSTOM-Li 3: PYLON-Li 4: RICHPOW-Li 5: TOPBANG-Li</pre>	<p>This interface is used to select battery type.</p> <p>Press UP/DOWN button to move corresponding options;</p> <p>Press ENTER button to enter the selected menu.</p> <p>Select the LEAD-ACID enter button to enter LEAD-ACID interface;</p> <p>Select the CUSTOM-Li enter button to enter the CUSTOM-Li interface;</p> <p>Select the PYLON_Li enter button to enter the restart interface.</p>

CUSTOM-Li battery parameter

Interface	Description
<pre>--CUSTOM-Li BAT-- 1:CHARG-VOLT →2:BAT END VOLT 3:BAT OVP</pre>	<p>This interface is used to select CUSTOM-Li battery parameter.</p> <p>Press Up/Down button to move corresponding options;</p> <p>Press ENTER button to enter the selected menu;</p>

Lead-acid battery parameter

Interface	Description
<pre> --LEAD-ACID-- →1:CHARG-VOLT 2:BAT END VOLT 3:BAT OVP 4:BAT CAP </pre>	<p>This interface is used to select LEAD-ACID battery parameter.</p> <p>Press Up/Down button to move corresponding options;</p> <p>Press Enter button to enter the selected menu</p>

① Charge voltage

Interface	Description
<pre> --CHARGE VOLT-- INPUT : 56.5 UNIT : V </pre>	<p>Press Up/Down button to increase or decrease the input figure;</p> <p>Press the Enter key to move the cursor backward, confirm the input and return to the battery parameter interface.</p> <p>Press Esc button to cancel the selection and return to battery parameters interface.</p>

② BAT END VOLT

Interface	Description
<pre> --BAT END VOLT-- INPUT : 43.2 UNIT : V </pre>	<p>Press Up/Down button to increase or decrease the input figure;</p> <p>Press Enter to move cursor backward, confirm input and return to battery parameters interface;</p> <p>Press ESC button to move cursor forward and return to battery parameters interface.</p>

③ BAT OVP

Interface	Description
<pre style="border: 1px solid black; padding: 10px;"> --BAT OVP-- INPUT : 56.5 UNIT : V </pre>	<p>Press Up/Down button to increase or decrease the input figure;</p> <p>Press Enter button to move cursor backward, confirm input and return to battery parameters interface;</p> <p>Press Esc button to move cursor forward and return to battery parameters interface.</p>

④ Battery capacity

Interface	Description
<pre style="border: 1px solid black; padding: 10px;"> --BAT CAP-- INPUT : 100 UNIT : AH </pre>	<p>Press Up/Down button to increase or decrease the input figure;</p> <p>Press Enter to move cursor backward, confirm input and return to battery parameters interface;</p> <p>Batteries capacity with a range of 50~1000;</p>

8.2.3 Grid standard

Interface	Description
<pre style="border: 1px solid black; padding: 10px;"> --GRID STD-- →1:220V/50HZ 2:230V/50HZ 3:240V/50HZ 4:220V/60HZ 5:230V/60HZ 6:240V/60HZ </pre>	<p>Press Up/Down button to move corresponding options;</p> <p>Press the Enter key to confirm the selection.</p> <p>Press ESC button to cancel the selection and return to setting interface (refer to 8.2).</p>

8.2.4 System setting

Interface	Description
<pre>--RUN SETTING-- →1:REACT MODE 2:GRID POWER 3:DISC POWER 4:VAC-MIN 5:VAC-MAX 6:FAC-MIN 7:FAC-MAX</pre>	<p>Press Up/Down button to move corresponding corresponding options;</p> <p>Press Enter to enter the selected menu;</p> <p>Press ESC button to return to setting interface.</p>

① Reactive mode

Interface	Description
<pre>--REACT MODE-- →1:POWER FACTOR 2:REACT POWER 3:QU WAVE 4:QP WAVE</pre>	<p>Press Up/Down button to move corresponding options;</p> <p>Press Enter to confirm the input and enter power factor setting interface; (select 2, press Enter to confirm input and enter reactive power interface; Select 3, 4, the corresponding mode will be selected and return to the parameter setting interface.)</p> <p>Press Esc button to cancel the input and return to operation parameters interface.</p>

Power factor setting

Interface	Description
<pre>-POWER FACTOR- INPUT: C1.00</pre>	<p>Press Up/Down to increase or decrease the input figure;</p> <p>Press Enter button to confirm or Esc button to cancel the input and return to working interface;</p> <p>The input value should range between L0.80 and L0.99 or C0.8 and C1.00.</p>
<pre>Value range (L1.00~C1.00)</pre>	

Reactive Power

Interface	Description
<div style="border: 1px solid black; padding: 5px; margin-bottom: 10px;"> -REACT POWER- INPUT: +60% </div> <div style="border: 1px solid black; padding: 5px;"> Value range (-60%~+60%) </div>	<p>Press Up/Down button to adjust the input figure.</p> <p>Press Enter button to confirm or Esc button to cancel the input and return to working interface;</p> <p>The input value should range between -60% and +60%, which varies with the standard.</p>

② Grid-connected power

Interface	Description
<div style="border: 1px solid black; padding: 5px; margin-bottom: 10px;"> -GRID PERCENT- INPUT: 100% </div> <div style="border: 1px solid black; padding: 5px;"> Value range (0~100) </div>	<p>Press Up/Down button to adjust the input figure;</p> <p>Press Enter button to confirm or Esc button to cancel the input and return to operation parameters interface;</p> <p>The input value should range between 0 and 100.</p>

③ Discharge power

Interface	Description
<div style="border: 1px solid black; padding: 5px; margin-bottom: 10px;"> -DISC PERCENT- INPUT: 050% </div> <div style="border: 1px solid black; padding: 5px;"> Value range (0~100) </div>	<p>Press Up/Down button to adjust the input figure;</p> <p>Press Enter button to confirm or Esc button to cancel the input and return to operation interface;</p> <p>The input value should range between 0 and 100.</p>

④ VAC-MIN

Interface	Description
<div style="border: 1px solid black; padding: 5px; margin-bottom: 10px;"> -GRID VOLT LOW- INPUT: UNIT: V </div> <div style="border: 1px solid black; padding: 5px;"> Value range (176~270V) </div>	<p>Grid Low Voltage Protection Point .</p> <p>Press Up/Down to adjust the input figure; Press Enter to confirm the input.</p> <p>Press ESC button to cancel the input and return to operation parameters interface;</p> <p>The value should range between 176V and 270, which varies with different standards.</p>

⑤ VAC-MAX

Interface	Description
<div style="border: 1px solid black; padding: 5px; margin-bottom: 5px;"> -GRID VOLT HIGH- INPUT: UNIT: V </div> <div style="border: 1px solid black; padding: 5px;"> Value range (240~280V) </div>	<p>Grid Over Voltage Protection Point. Press Up/Down to adjust the input figure; Press Enter to confirm the input.</p> <p>Press Esc to cancel the input and return to operation parameters interface;</p> <p>The value should range between 240V and 280V, which varies with different standards.</p>

⑥ FAC-MIN

Interface	Description
<div style="border: 1px solid black; padding: 5px; margin-bottom: 5px;"> -GRID FREQ LOW- INPUT: UNIT: Hz </div> <div style="border: 1px solid black; padding: 5px;"> Value range (45~49.8) </div>	<p>Grid Low Frequency Protection Point</p> <p>Press Up/Down to adjust the input figure; Press Enter to confirm the input.</p> <p>Press Esc to cancel the input and return to operation parameters interface;</p> <p>The value ranges between 45 and 49.8, which varies with different standards.</p>

⑦ FAC-MAX

Interface	Description
<div style="border: 1px solid black; padding: 5px; margin-bottom: 5px;"> -GRID FREQ HIGH- INPUT: 52.0 UNIT: Hz </div> <div style="border: 1px solid black; padding: 5px;"> Value range (50.2~55V) </div>	<p>Grid Over Frequency Protection Point. Press Up/Down to adjust the input number; Press Enter to confirm the input.</p> <p>Press ESC to cancel the input and return to operational parameters interface;</p> <p>The value ranges between 50.2 and 55, which varies with different standards.</p>

8.2.5 485 Address

Interface	Description
<pre>--485 ADDRESS-- INPUT: 1</pre> <pre>Value range (1~64)</pre>	<p>Press Up/Down button to adjust the input figure; Press Enter button to confirm or Esc button to cancel the input and return to setup interface;</p> <p>The input value should range between 1 and 64.</p>

8.2.6 485 Baud rate

Interface	Description
<pre>--BAUD RATE-- 1:2400bps 2:4800bps →3:9600bps</pre>	<p>Press Up/Down button to move corresponding options;</p> <p>Press Enter button to confirm or Esc button to cancel the selection and return to setup interface;</p> <p>There are three alternative options: 2400/4800/9600.</p>

8.2.7 Language

Interface	Description
<pre>--SELECT-- 1:CHINESE →2:ENGLISH</pre>	<p>Press Up/Down button to move corresponding options;</p> <p>Press Enter button to confirm or Esc button to cancel the selection and return to setup interface;</p>

8.2.8 LCD backlight

Interface	Description
<pre>--LIGHT TIME-- INPUT: 20 UNIT: SEC</pre>	<p>Press Up/Down button to adjust the input figure.</p> <p>Press Enter button to confirm or Esc button to cancel the input and return to setup interface;</p>
<pre>Value range (20~120)</pre>	<p>The input value should range between 20 and 120.</p>

8.2.9 Date/time

Interface	Description
<pre>--DATE/TIME-- DATE:2099-01-12 TIME:10:00:00 WEEK:Monday</pre>	<p>Press Up/Down button to adjust the input figure.</p> <p>Press Enter button to move cursor backward, confirm input and return to setup interface;</p> <p>Press Esc button to move cursor forward and return to setup interface;</p> <p>The input value should range between 2000 and 2099.</p>

8.2.10 Clear history

Interface	Description
<pre>--DEL REC -- 1: CANCEL →2: CONFIRM</pre>	<p>Clear all the previous history in Inquiry/Record menu.</p> <p>Press Up/Down button to move corresponding options;</p> <p>Press Enter button to confirm or Esc button to cancel the selection and return to setup interface.</p>

8.2.11 Password Setting

Interface	Description
<pre>--PASSWORD-- OLD: XXXXX NEW: XXXXX CONFIRM: XXXXX</pre>	<p>This interface will be used to change password for entry into the setup interface;</p> <p>Press Up/Down to adjust the input figure;</p> <p>Press Enter to move cursor backward, confirm input and return to setup interface;</p> <p>Press ESC to move cursor forward and return to setup interface;</p>

8.2.12 Maintenance

Interface	Description
<pre>--PASSWORD-- INPUT: XXXXX</pre>	<p>Maintainer use only.</p>

8.2.13 Factory reset

Interface	Description
<pre>-FACTORY RESET- →1:CANCEL 2:CONFIRM</pre>	<p>Press Up/Down button to move corresponding options;</p> <p>Press Enter to enter the selected item.</p>

8.2.14 Inquiry

Interface	Description
<pre>--INQUIRE-- →1:INV MODULE 2:MODULE SN 3:FIRMWARE 4:RECORD</pre>	<p>Press Up/Down button to move corresponding options;</p> <p>Press Enter button to jump to the selected meun.</p> <p>Press ESC button to return to user interface. (refer to 8.1.16);</p>

① INV MODULE

Interface	Description
<pre>--MODEL-- BD5KTL- RL1</pre>	<p>This interface displays machine model of The inverter;</p> <p>Press Esc button to return to inquiry interface.</p>

② MODULE SN

Interface	Description
<pre>--S/N-- GUID: 05DBFF38 430987323639424E</pre>	<p>This interface displays serial number of the inverter;</p> <p>This is unique for any device and in any context.</p>

③ Firmware Version

Interface	Description
<pre>--FIRMWARE-- ARM: V1.00.00 DSP: V1.00.00</pre>	<p>This interface displays firmware version for ARM and DSP of the inverter;</p> <p>Press ESC button to return to inquiry interface.</p>

④ Running records

Interface	Description
<pre>--REC(01)-- 02:Bat Disconnect UP: 01-12 00:00 DOWN:</pre>	<p>SN of the fault: Fault warning codes (500 At utmost)(the latest fault or alarm marked as No.1)</p> <p>UP:Time of the fault.</p> <p>Press Up/Down button to view the record; Press Enter button to enter the description interface for corresponding records;</p> <p>Press ESC button to return to Inquiry interface.</p>

8.2.12 Statistics

Interface	Description
<pre style="border: 1px solid black; padding: 10px;"> --STAT-- →1:TIME STAT. 2:CONNE. TIMES 3:PEAK POWER 4:E-TODAY 5:E-MONTH 6:E-YEAR 7:E-TOTAL </pre>	<p>This interface is used to select statistics items;</p> <p>Press Up/Down button to move corresponding options;</p> <p>Press Enter to enter the selected menu;</p> <p>Press ESC button to return to user interface.</p>

① TIME STAT

Interface	Description
<pre style="border: 1px solid black; padding: 10px;"> --Time-- RUN: 5 GRID: 0 UNIT: HOUR </pre>	<p>Operation length of inverter(hours)</p> <p>Grid-connection length(hours)</p> <p>Press ESC button to return to statistics interface.</p>

② CONNE. TIMES

Interface	Description
<pre style="border: 1px solid black; padding: 10px;"> -- CONNE. TIMES -- TIMES: 0 </pre>	<p>This interface displays grid-connection frequency of the inverter.</p> <p>Press ESC button to return to statistics interface.</p>

③ Peak power

Interface	Description
<pre>--PEAK POWER-- HISTORY: 5000 TODAY: 0 UNIT: W</pre>	<p>This interface displays power peak in history and for the day.</p> <p>Press ESC button to return to statistics interface.</p>

④ E-TODAY

Interface	Description
<pre>--E-TODAY-- PV: 0.0KWH GRID: 0.0KWH CNSUM: 0.0KWH</pre>	<p>This interface displays power generation for the day (KWH).</p> <p>PV power generation; Grid-connection power generation; Power consumption of load and inverter; Press ESC button to return to statistics interface.</p>

⑤ E-MONTH

Interface	Description
<pre>--E-MONTH-- PV: 0.0KWH GRID: 0.0KWH CNSUM 0.0KWH</pre>	<p>This interface displays power generation for the month (KWH).</p> <p>PV power generation; Grid-connection power generation; Power consumption of load and inverter; Press ESC button to return to statistics interface.</p>

⑥ E-YEAR

Interface	Description
<pre>--E-YEAR-- PV: 0.0KWH GRID: 0.0KWH CNSUM: 0.0KWH</pre>	<p>This interface displays power generation for the year (KWH);</p> <p>PV power generation; Grid-connection power generation; Power consumption of load and inverter; Press ESC button to return to statistics interface.</p>

⑦ E-TOTAL

Interface	Description
<div style="border: 1px solid black; padding: 5px;"> <p>--E-TOTAL--</p> <p>PV: 0.0KWH</p> <p>GRID: 0.0KWH</p> <p>CNSUM: 0.0KWH</p> </div>	<p>This interface displays gross power generation; PV power generation; Grid-connection power generation; Power consumption of load and inverter;</p> <p>Press ESC button to return to statistics interface.</p>

FAULT DIAGNOSIS AND SOLUTIONS

The inverter is easy to maintain. When you encounter the following problems, please refer to the Solutions below, and contact the local distributor if the problem remains unsolved. The following table lists some of the basic problems that may occur during the actual operation as well as their corresponding basic solutions.

Fault diagnosis table

Content	Codes	Solutions
DischgOverCur	00 29	<p>(1)nothing need to do, Wait one minute for the inverter to restart.</p> <p>(2)Check whether the load is in compliance with the specification.</p> <p>(3)Cut off all the power and shut down all the machines; disconnect the load and plug in to restart machines, then check whether the load is short circuited if the fault has been eliminated.</p> <p>(4)Contact customer service if error warning continues.</p>
Over Load	01	<p>(1)Check whether the load is in compliance with the maximum power of the machine.</p> <p>(2)Cut off all the power and shut down all the machines; disconnect the load and plug in to restart machines, then check whether the load is short circuited if the fault has been eliminated.</p> <p>(3)Contact customer service if error warning continues.</p>
BatDisconnect	02	<p>(1)Check if the battery not connected.</p> <p>(2)Check if battery wiring port is open circuited .</p> <p>(3)Contact customer service if error warning continues.</p>
Bat Under Vol	03 04 26	<p>(1)Check if the battery is in line with the presetting. If so, power off and restart.</p> <p>(2)Check if the grid is powered down. If the power is off, wait for the grid to powered up, the grid will automatically charge the battery.</p> <p>(3)Contact customer service if error warning continues.</p>

Bat Over Vol	05 27	(1)Check if the battery is in line with the presetting, If so, power off and restart. (2)Contact customer service if error warning continues.
grid low vol	06	(1)Check if the grid is abnormal. (2) Restart the inverter and wait until it functions normally. (3) Contact customer service if error warning continues.
grid over vol	07	(1)Check if the grid is abnormal. (2) Restart the inverter and wait until it functions normally. (3) Contact customer service if error warning continues.
grid low freq	08	(1)Check if the grid is abnormal. (2) Restart the inverter and wait until it functions normally. (3) Contact customer service if error warning continues.
grid overFreq	09	(1)Check if the grid is abnormal. (2) Restart the inverter and wait until it functions normally. (3) Contact customer service if error warning continues.
gfci over	10	(1)Check PV string for direct or indirect grounding phenomenon. (2)Check peripherals of machine for current leakage. (3)Contact the local inverter customer service if fault remains unremoved.
SolarUnconnect	11	(1)PV is not connected. (2)PV switch is not closed. (3)Check PV availability.
Grid CtReverse	12	(1)Check whether the CT is connected in the correct direction. (2)Contact customer service if error warning continues.

bus under vol	13	(1)Check the input mode setting is correct. (2)Restart the inverter and wait until it functions normally. (3)Contact customer service if error warning continues.
bus over vol	14	(1)Check the input mode setting is correct. (2)Restart the inverter and wait until it functions normally. (3)Contact customer service if error warning continues.
inv over cur	15	(1)Restart the inverter and wait until it functions normally. (2)Contact customer service if error warning continues.
chg over cur	16	(1)Check if battery wiring is short circuited. (2)Check if charging current is in compliance with presetting. (3)Contact customer service if error warning continues.
bus vol osc inv under vol inv over vol InvFreqAbnor	17 18 19 20	(1)Cut off all the power and shut down all the machines and restart. (2)Contact customer service if error warning continues.
env temp high	21	(1)Cut off all the power of the machine and wait one hour, then turn on the power of the machine. (2)Contact customer service if error warning continues.
bat over temp	23	(1)Disconnect the battery and reconnect it after an hour. (2)Contact customer service if error warning continues.
Bat UnderTemp	24	(1)Check the ambient temperature near the battery to see if it meets the specifications. (2)Contact customer service if error warning continues.
BatCellUnball	25	(1)Break the grid, use the battery to supply power to the load, reconnect the grid side switch after half an hour, Wait another half an hour and check the fault status again. (2)Contact customer service if error warning continues.

chg over cur	28	(1)Check if battery wiring port is short circuited . (2)Check if charging current is in compliance with presetting. (3)Contact customer service if error warning continues.
bus soft fail inv soft fail bus short inv short fan fault Bus Relay Fault Grid Rly Fault EPS rly fault gfcI fault Load Ct fault Off grid RlyFal system fault	32 33 34 35 36 38 39 40 41 42 44 45	(1)Restart the inverter and wait until it functions normally. (2)Contact customer service if error warning continues.
pviso low	37	(1)Check if the PE line is connected to the inverter and is connected to the ground. (2)Contact customer service if error warning continues.
pv short	43	(1)Restart the inverter and wait until it functions normally. (2)Disconnect the PV input, restart the inverter and wait until it functions normally. (3)Contact customer service if error warning continues.
bat reverse	46	(1)Check if the inverter battery positive and negative connection is correct. (2)Contact customer service if error warning continues.