



# CE-EMC TEST REPORT

For

**POWER SUPPLY -METAL DRIVER SERIES**

**Model No.:** VT-20025, VT-20026, VT-20040, VT-20045, VT-20060, VT-20061, VT-20075, VT-20076, VT-20100, VT-20120, VT-20121, VT-20150, VT-20151, VT-20200, VT-20250, VT-20350, VT-20500, VT-20122, VT-20152, VT-20062, VT-20077, VT-20153, VT-20027, VT-20030, VT-20101D, VT-20154D, VT-20155D, VT-20352

**Applicant :** V-TAC EXPORTS LIMITED

ROOM NO.301, KAM ON BUILDING 176A QUEENS ROAD CENTRAL, CENTRAL,  
HONGKONG

**Manufacturer :** V-TAC EXPORTS LIMITED

ROOM NO.301, KAM ON BUILDING 176A QUEENS ROAD CENTRAL, CENTRAL,  
HONGKONG

**Issued By :** Global-Standard Testing Service Co., Ltd.

Room 1911-1914, Noble Plaza, Qian Jin 1st Road,  
Bao An district, Shenzhen, Guangdong, China.

**Tel :** +86 755 33362599

**Email :** [market@gstslab.com](mailto:market@gstslab.com)



**Report Number :** M00.06.0085E-R2

**Issued Date :** January 17, 2019

**Date of Report :** January 17, 2019

**Note:**

1. The test data and result is based on the tested sample only.
2. Please verify information in the report on GST web: [www.gstslab.com](http://www.gstslab.com) through report number.
3. All rights reserve, the pirate edition investigates necessarily! This report shall not be reproduced unless under the authority of Global-Standard Testing Service Co., Ltd.
4. This report is based on report M00.06.0085E-R1 dated January 02, 2018.

## TABLE OF CONTENTS

<b>1. GENERAL INFORMATION.....</b>	<b>4</b>
1.1 Product Description for Equipment Under Test (EUT).....	4
1.2 Test Standards.....	5
1.3 TEST SUMMARY.....	5
1.4 Test Methodology.....	6
1.5 Test Instruments list.....	6
<b>2. SYSTEM TEST CONFIGURATION.....</b>	<b>7</b>
2.1 Justification.....	7
2.2 EUT Exercise Software.....	7
2.3 Equipment Modifications.....	7
<b>3. EMISSION TEST.....</b>	<b>8</b>
3.1 LIMITS.....	8
3.2 TEST PROCEDURES.....	8
3.3 TEST SETUP.....	9
3.4 TEST RESULTS.....	9
<b>4. RADIATED EMISSION MEASUREMENT.....</b>	<b>12</b>
4.1 LIMITS.....	12
4.2 TEST PROCEDURE.....	12
4.3 TEST SETUP.....	13
4.4 TEST RESULTS.....	13
<b>5. HARMONICS CURRENT MEASUREMENT.....</b>	<b>16</b>
5.1. LIMITS OF HARMONICS CURRENT MEASUREMENT.....	16
5.2. TEST PROCEDURE.....	16
5.3. TEST SETUP.....	17
5.4. TEST RESULTS.....	17
<b>6. Voltage Fluctuation and Flicker.....</b>	<b>18</b>
6.1. LIMITS OF VOLTAGE FLUCTUATION AND FLICKS MEASUREMENT.....	18
6.2 TEST SPECIFICATION.....	18
6.3 TEST SETUP.....	18
6.4 TEST RESULTS.....	18
<b>7. IMMUNITY TEST.....</b>	<b>19</b>
7.1 GENERAL DESCRIPTION.....	19
7.2 GENERAL PERFORMANCE CRITERIA DESCRIPTION.....	20
7.3 ELECTROSTATIC DISCHARGE (ESD).....	20
7.3.1 TEST SPECIFICATION.....	20
7.3.3 TEST PROCEDURE.....	21
7.3.4 TEST SETUP.....	22
7.3.5 TEST RESULTS.....	23
7.4 RADIATED, RADIO-FREQUENCY, ELECTROMAGNETIC FIELD (RS).....	23
7.4.1 TEST PROCEDURE.....	24
7.4.2 TEST SETUP.....	24
7.4.3 TEST RESULTS.....	25
7.5 ELECTRICAL FAST TRANSIENT (EFT).....	26
7.5.1 TEST SPECIFICATION.....	26
7.5.2 TEST PROCEDURE.....	26
7.5.3 TEST SETUP.....	27

7.5.4 TEST RESULTS.....	28
7.6 SURGE IMMUNITY TEST.....	28
7.6.1 TEST SPECIFICATION.....	28
7.6.2 TEST PROCEDURE.....	29
7.6.3 TEST SETUP.....	29
7.6.4 TEST RESULTS.....	30
7.7 CONDUCTED RADIO FREQUENCY DISTURBANCES (CS).....	31
7.7.1 TEST SPECIFICATION.....	31
7.7.2 TEST PROCEDURE.....	31
7.7.3 TEST SETUP.....	32
7.7.4 TEST RESULTS.....	32
7.8 VOLTAGE DIP & VOLTAGE INTERRUPTIONS.....	33
7.8.1 TEST SPECIFICATION.....	33
7.8.2 TEST PROCEDURE.....	33
7.8.3 TEST SETUP.....	33
7.8.4 TEST RESULTS.....	34
8. Test Setup Photographs.....	35
9. EUT PHOTOGRAPHS.....	36

# 1. GENERAL INFORMATION

## 1.1 Product Description for Equipment Under Test (EUT)

<b>Product:</b>	POWER SUPPLY -METAL DRIVER SERIES
<b>Model:</b>	VT-20350
<b>Rating:</b>	AC 85-265V, 50/60Hz, 350W
<b>Applicant:</b>	<b>V-TAC EXPORTS LIMITED</b> ROOM NO.301, KAM ON BUILDING 176A QUEENS ROAD CENTRAL, CENTRAL, HONGKONG
<b>Factory:</b>	<b>V-TAC EXPORTS LIMITED</b> ROOM NO.301, KAM ON BUILDING 176A QUEENS ROAD CENTRAL, CENTRAL, HONGKONG
<b>Test Voltage:</b>	AC 230V/50Hz
<b>Applicable Standards:</b>	EN 55032: 2015 EN 55024: 2010+A1 :2015 EN 61000-3-2:2014 EN 61000-3-3:2013

Deviation from Applicable Standard
None

The above equipment has been tested by Global-Standard Testing Service Co., Ltd. and found compliance with the requirements set forth in the technical standards mentioned above. The results of testing in this report apply only to the product/system, which was tested. Other similar equipment will not necessarily produce the same results due to production tolerance and measurement uncertainties.

<p><b>Tested By:</b> _____    Evan Chen</p> <p><b>Approved By:</b> _____    Nico Xie *</p>	<p><b>Date:</b> _____  January 14, 2019</p> <p><b>Date:</b> _____  January 17, 2019</p>
--	---

## 1.2 Test Standards

The following Declaration of Conformity report of EUT is prepared in accordance with

EN 55032: 2015

EN 55024: 2010+A1:2015

## 1.3 TEST SUMMARY

For the EUT described above. The standards used were EN 55032 Class B for Emissions & EN 55024 for Immunity.

Table 1: Tests Carried Out Under EN 55032: 2015(as amended)

Standard	Test Items	Status
EN 55032: 2015	Conducted (Main Port)	√
	Radiated Disturbances	√
EN 61000-3-2:2014	Harmonic current emissions	×
EN 61000-3-3:2013	Voltage fluctuations & flicker	×

√ Indicates that the test is applicable  
 × Indicates that the test is not applicable

Table 2: Tests Carried Out Under EN 55024: 2010+A1:2015 (as amended)

Standard	Test Items	Status
EN61000-4-2:2009	Meets the requirements of Performance Criterion B	√
EN61000-4-3:2006+A1:2008 +A2:2010	Meets the requirements of Performance Criterion A	√
EN61000-4-4:2012	Meets the requirements of Performance Criterion B	√
EN61000-4-5:2014	Meets the requirements of Performance Criterion B	√
EN61000-4-6:2014	Meets the requirements of Performance Criterion A	√
EN61000-4-11:2004	Meets the requirements of <b>Voltage dips:</b> 1) >95% reduction performance Criterion B 2) 30% reduction performance Criterion C <b>Voltage variations:</b> 1)>95% reduction performance Criterion C	√

√ Indicates that the test is applicable  
 × Indicates that the test is not applicable

## 1.4 Test Methodology

All measurements contained in this report were conducted with CISPR 16-1: 2002, radio disturbance and immunity measuring apparatus, and CISPR16-2: 2002, Method of measurement of disturbances and immunity.

All measurement required was performed at laboratory of SEM Testing Technology Co., Ltd.

1/F, Building A, Hongwei Industrial Park, Liuxian 2nd Road, Bao'an District, Shenzhen, P.R.C.

## 1.5 Test Instruments list

Immunity shielded room				
Name of Equipment	Manufacturer	Model	Serial Number	Calibration Due
EMC PARTNER TRANSIENT 2000	EMC PARTNER	TRA2000	881	09/27/2018
Power-frequency Magnetic field	SCHAFFNER	CCN 1000-1	72046	09/27/2018
Induction Coil Interface	SCHAFFNER	INA2141	6003	09/27/2018
Signal Generator	Marconi	2022D	119246/003	09/27/2018
Power Amplifier	M2S	A00181-1000	9801-112	09/27/2018
CDN	MEB	M3-8016	003683	09/27/2018
Power Amplifier	M2S	AC8113/800-250A	9801-179	09/27/2018
Power Antenna	SCHAFFNER	CBL6140A	1204	09/27/2018
ESD 2000	EMC PARTNER	ESD2000	182	09/27/2018
Harmonic & Flicker Tester	California instruments	PACS-3	SB2588/01	09/27/2018
AC Power Source	California instruments	5001iX-CTS-40	SB2588	09/27/2018
EMI Test Receiver	R&S	ESCI	100005	09/27/2018
Spectrum Analyzer	R&S	FSU	100114	09/27/2018
Pre Amplifier	H.P.	HP8447E	2945A02715	09/27/2018
Bilog Antenna	SUNOL Sciences	JB3	A021907	09/27/2018
Cable	TIME MICROWAVE	LMR-400	N-TYPE04	09/27/2018
System-Controller	CCS	N/A	N/A	N.C.R
Turn Table	CCS	N/A	N/A	N.C.R
Antenna Tower	CCS	N/A	N/A	N.C.R
Triple-Loop Antenna	EVERFINE	LLA-2	N/A	09/27/2018
LISN	AFJ	LS16	16010222119	09/27/2018
LISN(EUT)	Mestec	AN3016	04/10040	09/27/2018

## **2. SYSTEM TEST CONFIGURATION**

### **2.1 Justification**

The system was configured for testing in a typical fashion (as normally used by a typical user).

### **2.2 EUT Exercise Software**

The EUT exercising program used during radiated and conducted testing was designed to exercise the various system components in a manner similar to a typical use. The software offered by manufacture, can let the EUT being normal operation.

### **2.3 Equipment Modifications**

The EUT tested was not modified by SEM Testing Technology Co., Ltd.  
1/F, Building A, Hongwei Industrial Park, Liuxian 2nd Road, Bao'an District, Shenzhen, P.R.C.

### 3. EMISSION TEST

#### 3.1 LIMITS

FREQUENCY (MHz)	Class B (dBuV)	
	Quasi-peak	Average
0.15 - 0.5	66 - 56	56 - 46
0.50 - 5.0	56	46
5.0 - 30.0	60	50

**NOTE:**

- (1) The lower limit shall apply at the transition frequencies.
- (2) The limit decreases in line with the logarithm of the frequency in the range of 0.15 to 0.50 MHz.
- (3) All emanations from a class A/B digital device or system, including any network of conductors and apparatus connected thereto, shall not exceed the level of field strengths specified above.

#### 3.2 TEST PROCEDURES

##### Procedure of Preliminary Test

The EUT and Support equipment, if needed, was set up as per the test configuration to simulate typical usage per the user's manual. When the EUT is a tabletop system, a wooden table with a height of 0.8 meters is used and is placed on the ground plane as per EN55032 (see Test Facility for the dimensions of the ground plane used). When the EUT is a floor standing equipment, it is placed on the ground plane, which has a 3-12 mm non-conductive covering to insulate the EUT from the ground plane.

All I/O cables were positioned to simulate typical actual usage as per EN55032.

The EUT test program was started. Emissions were measured on each current carrying line of the EUT using an EMI Test Receiver connected to the LISN powering the EUT.

The Receiver scanned from 150kHz to 30MHz for emissions in each of the test modes.

During the above scans, the emissions were maximized by cable manipulation.

The test mode(s) described in Item 3.1 were scanned during the preliminary test.

After the preliminary scan, we found the test mode described in Item 3.1 producing the highest emission level.

The EUT configuration and cable configuration of the above highest emission levels were recorded for reference of the final test.

##### Procedure of Final Test

EUT and support equipment were set up on the test bench as per the configuration with highest emission level in the preliminary test.

A scan was taken on both power lines, Line 1 and Line 2, recording at least the six highest emissions. Emission frequency and amplitude were recorded into a computer in which correction factors were used to calculate the emission level and compare reading to the applicable limit.

The test data of the worst-case condition(s) was recorded.



### 3.3 TEST SETUP

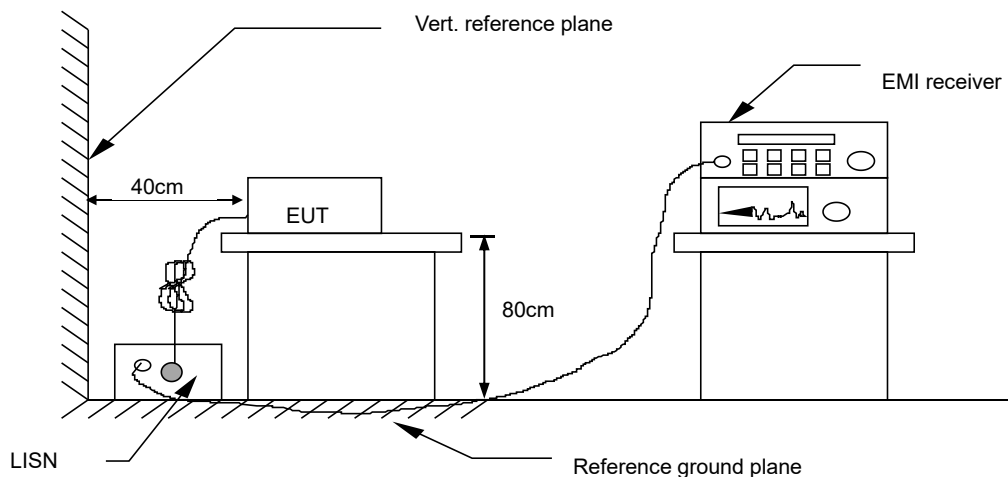

For the actual test configuration, please refer to the related item – Photographs of the Test Configuration.

### 3.4 TEST RESULTS

Temperature ( °C )	22~28
Humidity ( %RH )	50~57
Barometric Pressure ( mbar )	950~1000
EUT	POWER SUPPLY -METAL DRIVER SERIES
M/N	VT-20350
Operating Mode	Full Load
Test Results	PASS

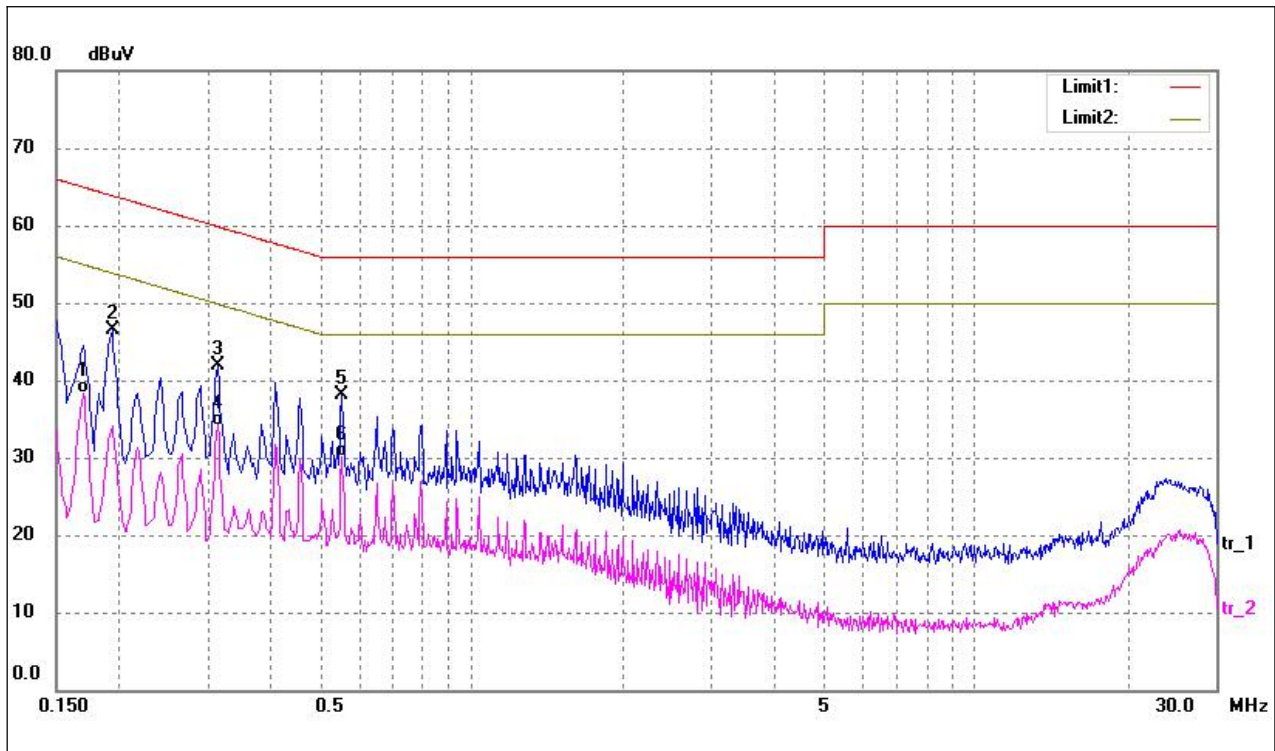

EUT:	POWER SUPPLY -METAL DRIVER SERIES	Model Name. :	VT-20350
Temperature:	26 °C	Relative Humidity:	54%
Pressure:	1010hPa	Test Date:	December 29, 2017
Test Mode:	Full Load	Phase:	L
Test Voltage :	AC 230V/50Hz		

No.	Frequency (MHz)	Reading (dBuV)	Correct (dB/m)	Result (dBuV)	Limit (dBuV)	Margin (dB)	Detector
1	0.1700	28.48	9.83	38.31	54.96	-16.65	AVG
2	0.1940	36.61	9.81	46.42	63.86	-17.44	peak
3	0.3140	32.16	9.80	41.96	59.86	-17.90	peak
4*	0.3140	24.40	9.80	34.20	49.86	-15.66	AVG
5	0.5540	28.28	9.80	38.08	56.00	-17.92	peak
6	0.5540	20.28	9.80	30.08	46.00	-15.92	AVG

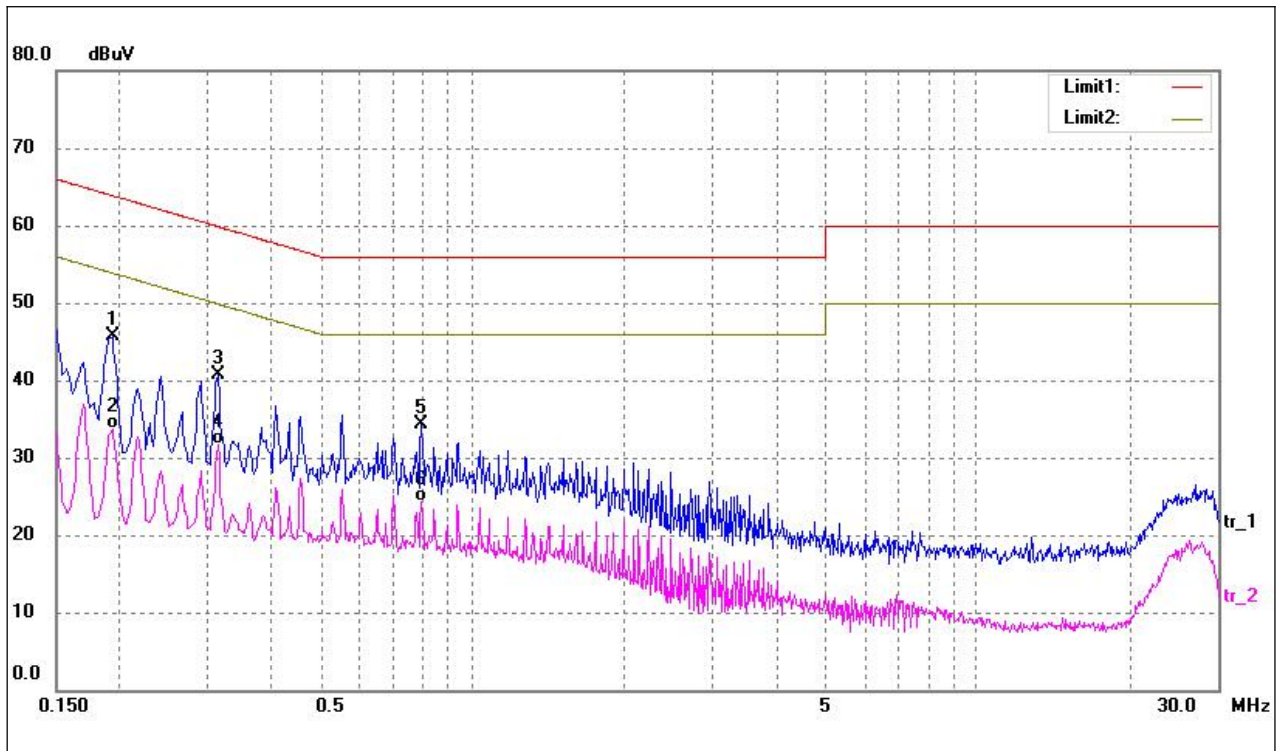

EUT:	POWER SUPPLY -METAL DRIVER SERIES	Model Name. :	VT-20350
Temperature:	26 °C	Relative Humidity:	54%
Pressure:	1010hPa	Test Date:	December 29, 2017
Test Mode:	Full Load	Phase:	N
Test Voltage :	AC 230V/50Hz		

No.	Frequency (MHz)	Reading (dBuV)	Correct (dB/m)	Result (dBuV)	Limit (dBuV)	Margin (dB)	Detector
1*	0.1940	35.88	9.81	45.69	63.86	-18.17	peak
2	0.1940	23.87	9.81	33.68	53.86	-20.18	AVG
3	0.3140	30.90	9.80	40.70	59.86	-19.16	peak
4	0.3140	21.88	9.80	31.68	49.86	-18.18	AVG
5	0.7940	24.60	9.78	34.38	56.00	-21.62	peak
6	0.7940	14.61	9.78	24.39	46.00	-21.61	AVG

## 4. RADIATED EMISSION MEASUREMENT

### 4.1 LIMITS

FREQUENCY (MHz)	dBuV/m (At 3m)
	Limit
30 ~ 230	40
230 ~ 1000	47

**NOTE:** (1) The lower limit shall apply at the transition frequencies.

(2) Emission level (dBuV/m) = 20 log Emission level (uV/m).

### 4.2 TEST PROCEDURE

#### Procedure of Preliminary Test

The equipment was set up as per the test configuration to simulate typical usage per the user's manual. When the EUT is a tabletop system, a wooden turntable with a height of 0.8 meters is used which is placed on the ground plane. When the EUT is a floor standing equipment, it is placed on the ground plane which has a 3-12 mm non-conductive covering to insulate the EUT from the ground plane.

Support equipment, if needed, was placed as per EN55032.

All I/O cables were positioned to simulate typical usage as per EN55032.

Power cables, telephone lines or other connections to auxiliary equipment located outside the test area shall drape to the floor, be fitted with ferrite clamps or ferrite tubes placed on the floor at the point where the cable reaches the floor and then routed to the place where they leave the turntable. No extension cords shall be used to mains receptacle.

The antenna was placed at 3 meter away from the EUT as stated in EN 55032. The antenna connected to the Spectrum Analyzer via a cable and at times a pre-amplifier would be used.

The Analyzer / Receiver quickly scanned from 30MHz to 1000MHz. The EUT test program was started. Emissions were scanned and measured rotating the EUT to 360 degrees and positioning the antenna 1 to 4 meters above the ground plane, in both the vertical and the horizontal polarization, to maximize the emission reading level.

The test mode(s) described in Item 3.1 were scanned during the preliminary test:

After the preliminary scan, we found the test mode described in Item 3.1 producing the highest emission level. The EUT and cable configuration, antenna position, polarization and turntable position of the above highest emission level were recorded for the final test.

#### Procedure of Final Test

EUT and support equipment were set up on the turntable as per the configuration with highest emission level in the preliminary test.

The Analyzer / Receiver scanned from 30MHz to 1000MHz. Emissions were scanned and measured rotating the EUT to 360 degrees, varying cable placement and positioning the antenna 1 to 4 meters above the ground plane, in both the vertical and the horizontal polarization, to maximize the emission reading level.

Recorded at least the six highest emissions. Emission frequency, amplitude, antenna position, polarization and turntable position were recorded into a computer in which correction factors were used to calculate the emission level and compare reading to the applicable limit and only Q.P. reading is presented.

The test data of the worst-case condition(s) was recorded.

### 4.3 TEST SETUP

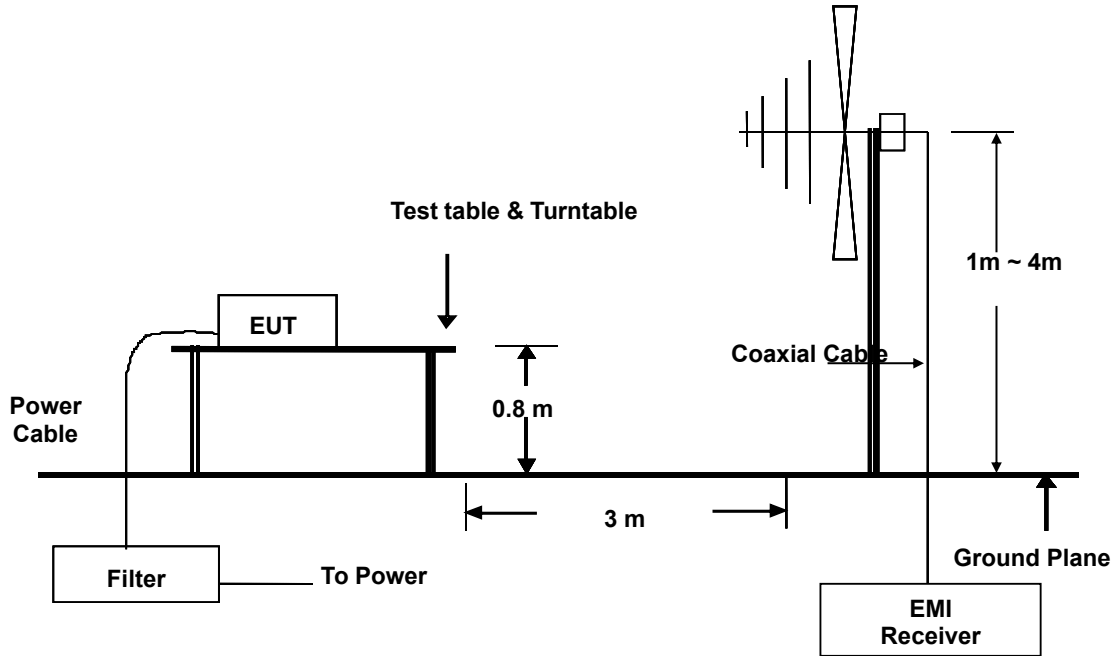

For the actual test configuration, please refer to the related item – Photographs of the Test Configuration

### 4.4 TEST RESULTS

Temperature ( °C )	22~28
Humidity ( %RH )	50~57
Barometric Pressure ( mbar )	950~1000
EUT	POWER SUPPLY -METAL DRIVER SERIES
M/N	VT-20350
Operating Mode	Full Load
Test Results	PASS

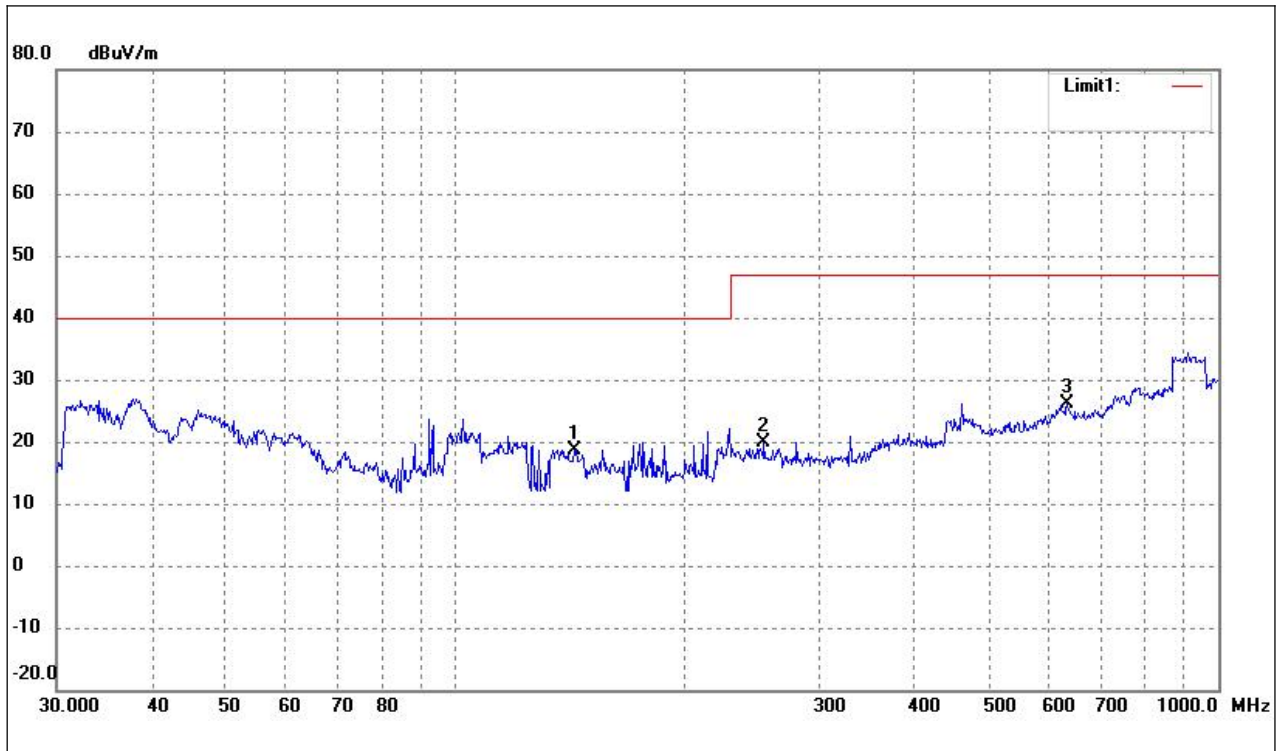

EUT:	POWER SUPPLY -METAL DRIVER SERIES	Model Name. :	VT-20350
Temperature:	26 °C	Relative Humidity:	54%
Pressure:	1010hPa	Test Date:	December 29, 2017
Test Mode:	Full Load	Phase:	Vertical
Test Voltage :	AC 230V/50Hz		

No.	Frequency (MHz)	Reading (dBuV/m)	Correct (dB/m)	Result (dBuV/m)	Limit (dBuV/m)	Margin (dB)	Degree ( )	Height (cm)	Remark
1	143.3261	33.51	-14.85	18.66	40.00	-21.34			peak
2	253.8367	30.34	-10.34	20.00	47.00	-27.00			peak
3	633.9073	29.09	-3.08	26.01	47.00	-20.99			peak



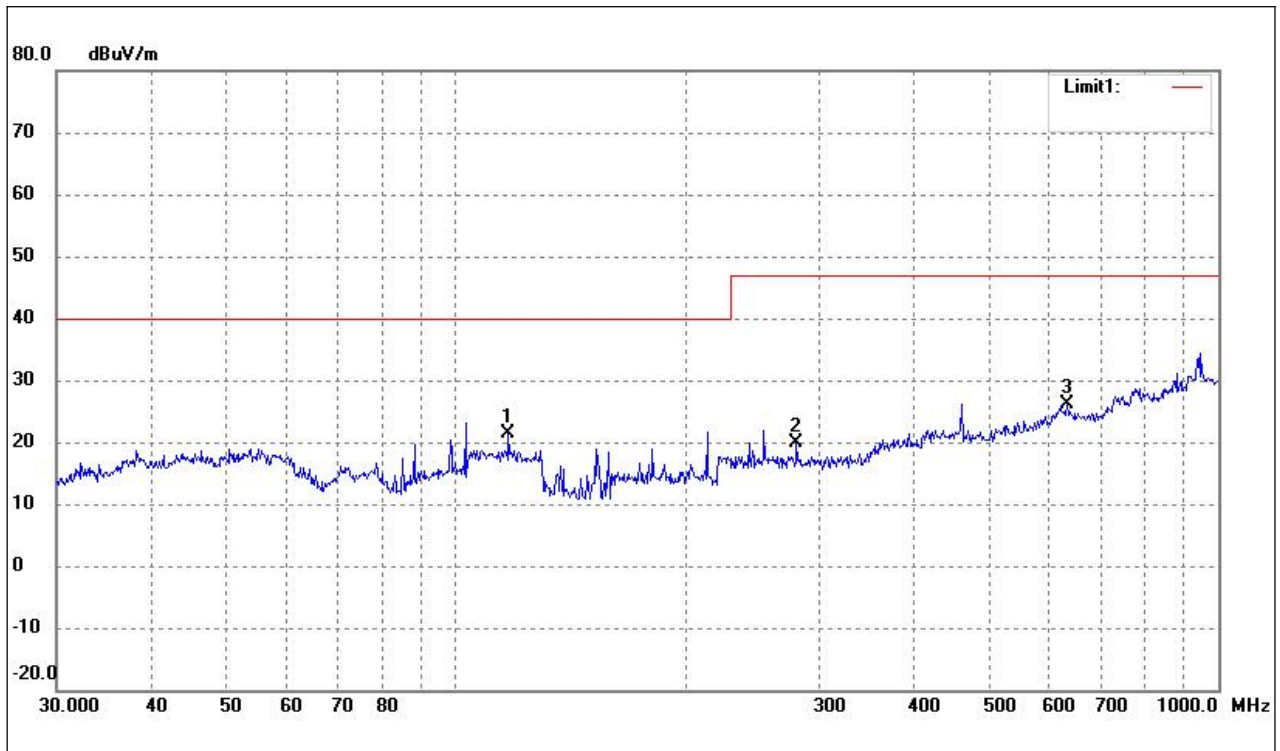

EUT:	POWER SUPPLY -METAL DRIVER SERIES	Model Name. :	VT-20350
Temperature:	26 °C	Relative Humidity:	54%
Pressure:	1010hPa	Test Date:	December 29, 2017
Test Mode:	Full Load	Phase:	Horizontal
Test Voltage :	AC 230V/50Hz		

No.	Frequency (MHz)	Reading (dBuV/m)	Correct (dB/m)	Result (dBuV/m)	Limit (dBuV/m)	Margin (dB)	Degree ( )	Height (cm)	Remark
1	117.3603	34.84	-13.40	21.44	40.00	-18.56			peak
2	280.0238	29.35	-9.51	19.84	47.00	-27.16			peak
3	633.9073	29.09	-3.08	26.01	47.00	-20.99			peak

## 5. HARMONICS CURRENT MEASUREMENT

### 5.1. LIMITS OF HARMONICS CURRENT MEASUREMENT

Limits for Class A equipment		Limits for Class D equipment		
Harmonics Order n	Max. permissible harmonics current A	Harmonics Order n	Max. permissible harmonics current per watt mA/W	Max. permissible harmonics current A
Odd harmonics		Odd Harmonics only		
3	2.30	3	3.4	2.30
5	1.14	5	1.9	1.14
7	0.77	7	1.0	0.77
9	0.40	9	0.5	0.40
11	0.33	11	0.35	0.33
13	0.21	13	0.30	0.21
15<=n<=39	0.15x15/n	15<=n<=39	3.85/n	0.15x15/n
Even harmonics				
2	1.08			
4	0.43			
6	0.30			
8<=n<=40	0.23x8/n			

**NOTE:** 1. Class A and Class D are classified according to item 4.4.3.

2. According to section 7 of EN 61000-3-2, the above limits apply for all equipments with a rated power more than 75W, except for lighting equipment.

### 5.2. TEST PROCEDURE

The EUT was placed on the top of a wooden table 0.8 meters above the ground and operated to produce the maximum harmonic components under LIGHTING operating conditions for each successive harmonic component in turn.

The classification of EUT is according to section 5 of EN 61000-3-2.

The EUT is classified as follows:

Class A: Balanced three-phase equipment, Household appliances excluding equipment as Class D, Tools excluding portable tools, Dimmers for incandescent lamps, audio equipment, equipment not specified in one of the three other classes.

Class B: Portable tools; Arc welding equipment which is not professional equipment.

Class C: Lighting equipment.

Class D: Equipment having a specified power less than or equal to 600 W of the following types: Personal computers and personal computer monitors and television receivers.

The correspondent test program of test instrument to measure the current harmonics emanated from EUT is chosen. The measure time shall be not less than the time necessary for the EUT to be exercised.



### 5.3. TEST SETUP

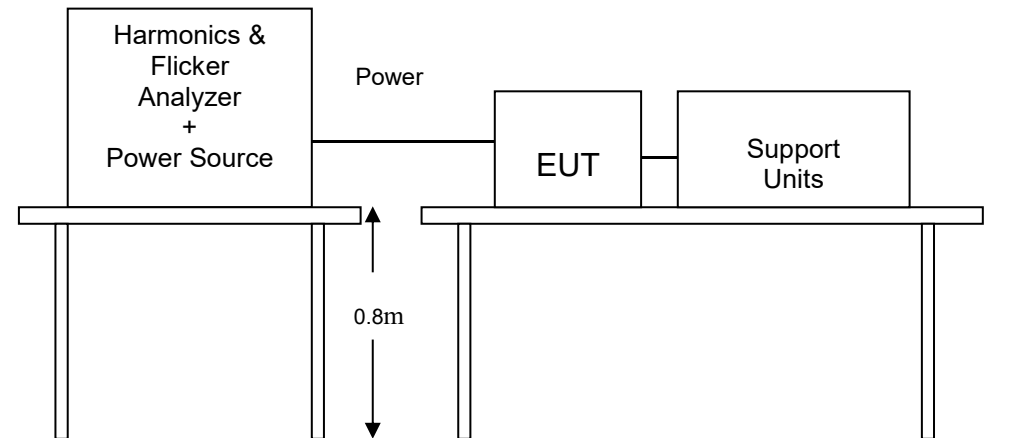

For the actual test configuration, please refer to the related item.

### 5.4. TEST RESULTS

Temperature ( °C )	22~28
Humidity ( %RH )	50~58
Barometric Pressure ( mbar )	950~1000
EUT	POWER SUPPLY -METAL DRIVER SERIES
M/N	VT-20350
Operating Mode	Full Load
Test Results	N/A

## 6. Voltage Fluctuation and Flicker

### 6.1. LIMITS OF VOLTAGE FLUCTUATION AND FLICKS MEASUREMENT

TEST ITEM	LIMIT	REMARK
$P_{st}$	1.0	$P_{st}$ means short-term flicker indicator.
$P_{lt}$	0.65	$P_{lt}$ means long-term flicker indicator.
$T_{dt}$ (ms)	500	$T_{dt}$ means maximum time that dt exceeds 3 %.
$d_{max}$ (%)	4%	$d_{max}$ means maximum relative voltage change.
dc (%)	3.3%	dc means relative steady-state voltage change

### 6.2 TEST SPECIFICATION

The EUT was placed on the top of a wooden table 0.8 meters above the ground and operated to produce the most unfavorable sequence of voltage changes under normal operating conditions.

During the flick measurement, the measure time shall include that part of whole operation cycle in which the EUT produce the most unfavorable sequence of voltage changes. The observation period for short-term flicker indicator is 10 minutes and the observation period for long-term flicker indicator is 2 hours.

### 6.3 TEST SETUP

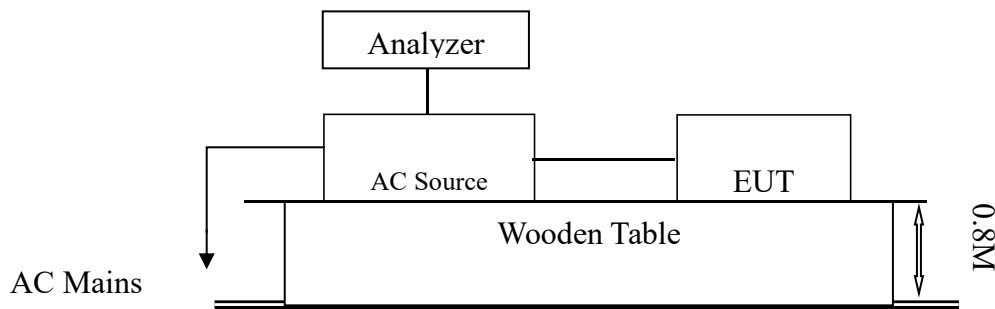

### 6.4 TEST RESULTS

Temperature ( °C )	22~28
Humidity ( %RH )	50~57
Barometric Pressure ( mbar )	950~1000
EUT	POWER SUPPLY -METAL DRIVER SERIES
M/N	VT-20350
Operating Mode	Full Load
Test Results	N/A

## 7. IMMUNITY TEST

### 7.1 GENERAL DESCRIPTION

Product Standard	EN 55024: 2010+A1:2015	
	Test Type	Minimum Requirement
Basic Standard, Specification, and Performance Criterion required	EN 61000-4-2	Electrostatic Discharge – ESD: 8kV air discharge, 4kV Contact discharge, Performance Criterion B
	EN 61000-4-3	Radio-Frequency Electromagnetic Field Susceptibility Test – RS: 80 ~1000 MHz, 3V/m, 80% AM(1kHz), Performance Criterion A
	EN 61000-4-4	Electrical Fast Transient/Burst - EFT, Power line: 1kV, Signal line: 0.5kV, Performance Criterion B
	EN 61000-4-5	Surge Immunity Test: 1.2/50 us Open Circuit Voltage, 8 /20 us Short Circuit Current, Power Port ~ Line to line: 1kV, Line to ground: 2kV Signal Port ~ Lines to ground : 1kV Performance Criterion B
	EN 61000-4-6	Conducted Radio Frequency Disturbances Test –CS: 0.15 ~ 80 MHz, 3Vrms, 80% AM, 1kHz, Performance Criterion A
	EN 61000-4-11	Voltage Dips: i) >95% reduction for 0.5 period, Performance Criterion B ii) 30% reduction for 25 period, Performance Criterion C Voltage Interruptions: >95% reduction for 250 period Performance Criterion C

## 7.2 GENERAL PERFORMANCE CRITERIA DESCRIPTION

<b>Criteria A:</b>	The apparatus shell continues to operate as intended without operator intervention. No degradation of performance or loss of function is allowed below a performance level specified by the manufacturer, when the apparatus is used as intended. The performance level may be replaced by a permissible loss of performance. If the manufacturer does not specify the minimum performance level or the permissible performance loss, then either of these may be derived from the product description and documentation, and by what the user may reasonably expect from the equipment if used as intended.
<b>Criteria B:</b>	<p>After test, the apparatus shell continues to operate as intended without operator intervention. No degradation of performance or loss of function is allowed, after the application of the phenomenon below a performance level specified by the manufacturer, when the apparatus is used as intended. The performance level may be replaced by a permissible loss of performance.</p> <p>During the test, degradation of performance is however allowed. However, no change of operating state if stored data is allowed to persist after the test. If the manufacturer does not specify the minimum performance level or the permissible performance loss, then either of these may be derived from the product description and documentation, and by what the user may reasonably expect from the equipment if used as intended.</p>
<b>Criteria C:</b>	<p>Temporary loss of function is allowed, provided the functions is self-recoverable or can be restored by the operation of controls by the user in accordance with the manufacturer instructions.</p> <p>Functions, and/or information stored in non-volatile memory, or protected by a battery backup, shall not be lost.</p>

## 7.3 ELECTROSTATIC DISCHARGE (ESD)

### 7.3.1 TEST SPECIFICATION

<b>Basic Standard:</b>	EN 61000-4-2
<b>Discharge Impedance:</b>	330 ohm
<b>Charging Capacity:</b>	150pF
<b>Discharge Voltage:</b>	Air Discharge: 8 kV (Direct) Contact Discharge: 4 kV (Direct/Indirect)
<b>Polarity:</b>	Positive & Negative
<b>Number of Discharge:</b>	Minimum 25 times at each test point
<b>Discharge Mode:</b>	1 time/s
<b>Performance Criterion:</b>	B

### 7.3.3 TEST PROCEDURE

The discharges shall be applied in two ways:

- a) Contact discharges to the conductive surfaces and coupling planes:  
The EUT shall be exposed to at least 200 discharges, 100 each at negative and positive polarity, at a minimum of four test points. One of the test points shall be subjected to at least 50 indirect discharges to the center of the front edge of the **Horizontal Coupling Plane (HCP)**. The remaining three test points shall each receive at least 50 direct contact discharges. If no direct contact test points are available, then at least 200 indirect discharges shall be applied in the indirect mode. Test shall be performed at a maximum repetition rate of one discharge per second.
- b) Air discharges at slots and apertures and insulating surfaces:  
On those parts of the EUT where it is not possible to perform contact discharge testing, the equipment should be investigated to identify user accessible points where breakdown may occur. Such points are tested using the air discharge method. This investigation should be restricted to those area Full Load handled by the user. A minimum of 10 single air discharges shall be applied to the selected test point for each such area.

The basic test procedure was in accordance with IEC 61000-4-2:

- a) The EUT was located 0.1 m minimum from all side of the **HCP** (dimensions 1.6m x 0.8m).
- b) The support units were located another table 30 cm away from the EUT, but direct support unit was/were located at same location as EUT on the HCP and keep at a distance of 10 cm with EUT.
- c) The time interval between two successive single discharges was at least 1 second.
- d) Contact discharges were applied to the non-insulating coating, with the pointed tip of the generator penetrating the coating and contacting the conducting substrate.
- e) Air discharges were applied with the round discharge tip of the discharge electrode approaching the EUT as fast as possible (without causing mechanical damage) to touch the EUT. After each discharge, the ESD generator was removed from the EUT and re-triggered for a new single discharge. The test was repeated until all discharges were complete.
- f) At least ten single discharges (in the most sensitive polarity) were applied at the front edge of each **HCP** opposite the center point of each unit of the EUT and 0.1 meters from the front of the EUT. The long axis of the discharge electrode was in the plane of the **HCP** and perpendicular to its front edge during the discharge.
- g) At least ten single discharges (in the most sensitive polarity) were applied to the center of one vertical edge of the **Vertical Coupling Plane (VCP)** in sufficiently different positions that the four faces of the EUT were completely illuminated. The **VCP** (dimensions 0.5m x 0.5m) was placed vertically to and 0.1 meters from the EUT.

### 7.3.4 TEST SETUP

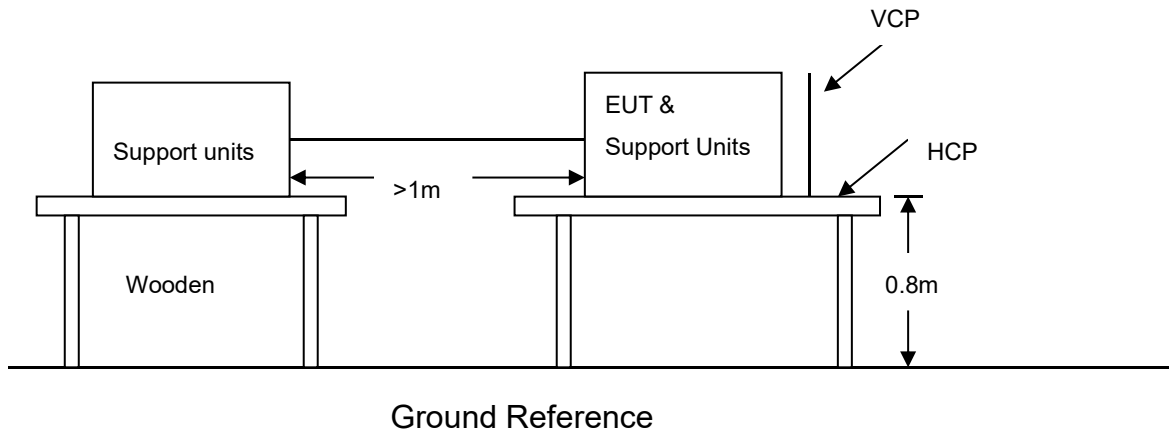

For the actual test configuration, please refer to the related item – Photographs of the Test Configuration.

#### NOTE:

##### TABLE-TOP EQUIPMENT

The configuration consisted of a wooden table 0.8 meters high standing on the Ground Reference Plane. The GRP consisted of a sheet of aluminum at least 0.25mm thick, and 2.5 meters square connected to the protective grounding system. A Horizontal Coupling Plane (1.6m x 0.8m) was placed on the table and attached to the GRP by means of a cable with 940k total impedance. The equipment under test, was installed in a representative system as described in section 7 of EN 61000-4-2, and its cables were placed on the HCP and isolated by an insulating support of 0.5mm thickness. A distance of 1-meter minimum was provided between the EUT and the walls of the laboratory and any other metallic structure.

##### FLOOR-STANDING EQUIPMENT

The equipment under test was installed in a representative system as described in section 7 of IEC 61000-4-2, and its cables were isolated from the Ground Reference Plane by an insulating support of 0.1-meter thickness. The GRP consisted of a sheet of aluminum that is at least 0.25mm thick, and 2.5 meters square connected to the protective grounding system and extended at least 0.5 meters from the EUT on all sides.

### 7.3.5 TEST RESULTS

Temperature ( °C )	22~28
Humidity ( %RH )	50~57
Barometric Pressure ( mbar )	950~1000
EUT	POWER SUPPLY -METAL DRIVER SERIES
M/N	VT-20350
Operating Mode	Full Load
Test Results	PASS

Air Discharge						
Test locations	Test Levels	Results				
		± 8 kV	Pass	Fail	Performance Criterion	Observation
Slot 4Points	<input checked="" type="checkbox"/>	<input checked="" type="checkbox"/>	<input type="checkbox"/>	B	Note <input type="checkbox"/> 1 <input checked="" type="checkbox"/> 2	

Contact Discharge						
Test Points	Test Levels	Results				
		± 4 kV	Pass	Fail	Performance Criterion	Observation
DC Port 2Points	<input checked="" type="checkbox"/>	<input checked="" type="checkbox"/>	<input type="checkbox"/>	B	Note <input type="checkbox"/> 1 <input checked="" type="checkbox"/> 2	
HCP 4Points	<input checked="" type="checkbox"/>	<input checked="" type="checkbox"/>	<input type="checkbox"/>	B	Note <input type="checkbox"/> 1 <input checked="" type="checkbox"/> 2	
VCP 4Points	<input checked="" type="checkbox"/>	<input checked="" type="checkbox"/>	<input type="checkbox"/>	B	Note <input type="checkbox"/> 1 <input checked="" type="checkbox"/> 2	

**NOTE:** 1. There was no change compared with initial operation during the test.  
 2. The loss of function of the EUT during the test and it was recovered by itself operation after the test.

### 7.4 RADIATED, RADIO-FREQUENCY, ELECTROMAGNETIC FIELD (RS)

<b>Basic Standard:</b>	EN 61000-4-3
<b>Frequency Range:</b>	80 MHz ~1000 MHz,
<b>Field Strength:</b>	3 V/m
<b>Modulation:</b>	1kHz Sine Wave, 80%, AM Modulation
<b>Frequency Step:</b>	1 % of preceding frequency value
<b>Polarity of Antenna:</b>	Horizontal and Vertical
<b>Test Distance:</b>	3 m
<b>Antenna Height:</b>	1.5m
<b>Performance Criterion:</b>	A

### 7.4.1 TEST PROCEDURE

The test procedure was in accordance with EN 61000-4-3

- a) The testing was performed in a fully anechoic chamber. The transmit antenna was located at a distance of 3 meters from the EUT.
- b) The frequency range is swept from 80 MHz to 1000 MHz, with the signal 80% amplitude modulated with a 1kHz sine-wave. The rate of sweep did not exceed  $1.5 \times 10^{-3}$  decade/s, where the frequency range is swept incrementally, the step size was 1% of preceding frequency value.
- c) The dwell time at each frequency shall be not less than the time necessary for the EUT to be able to respond.
- d) The test was performed with the EUT exposed to both vertically and horizontally polarized fields on each of the four sides.

### 7.4.2 TEST SETUP

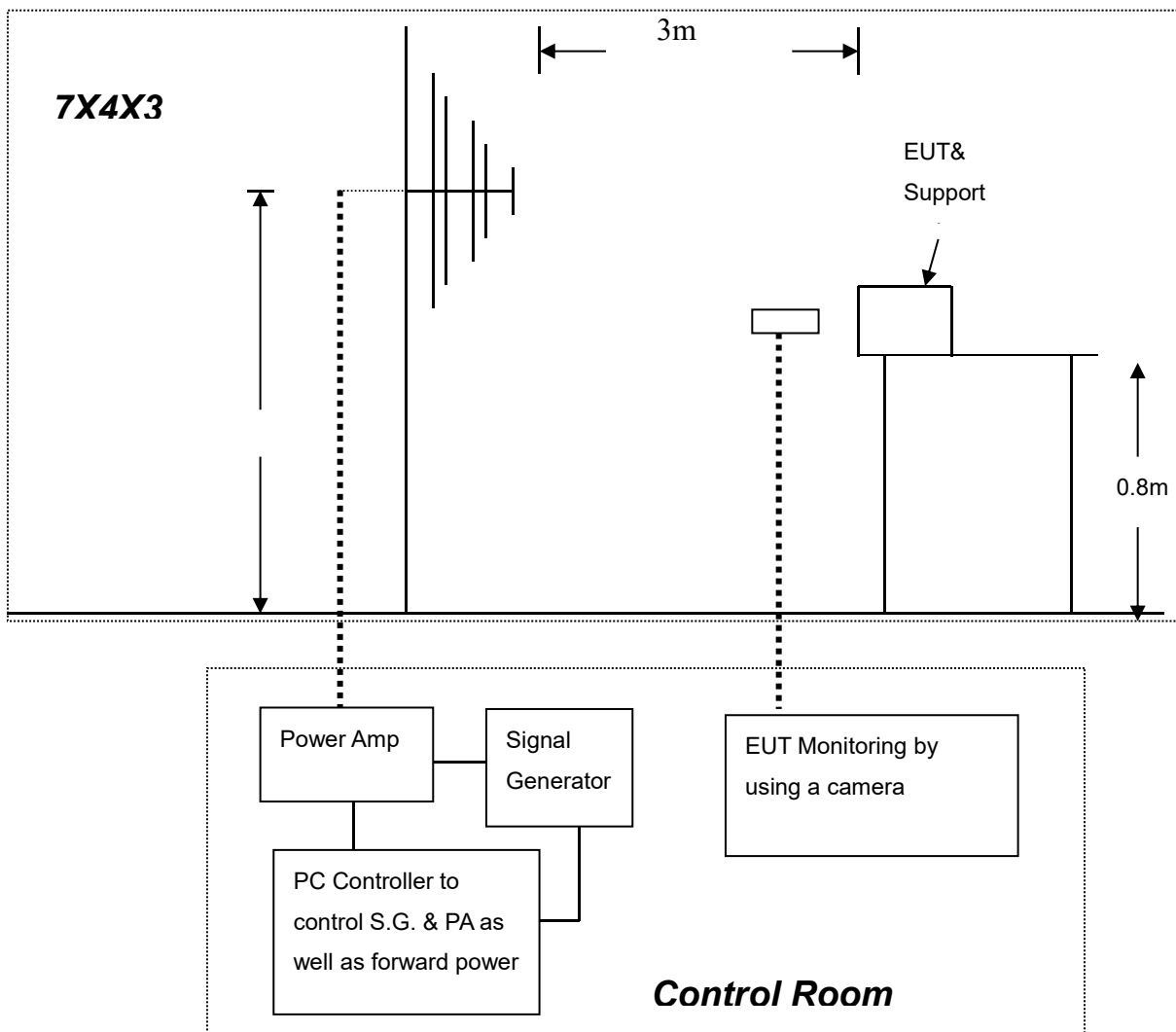



For the actual test configuration, please refer to the related item .

**NOTE:**

TABLETOP EQUIPMENT

The EUT installed in a representative system as described in section 7 of EN 61000-4-3 was placed on a non-conductive table 0.8 meters in height. The system under test was connected to the power and signal wire according to relevant installation instructions.

FLOOR STANDING EQUIPMENT

The EUT installed in a representative system as described in section 7 of IEC 61000-4-3 was placed on a non-conductive wood support 0.1 meters in height. The system under test was connected to the power and signal wire according to relevant installation instructions.

**7.4.3 TEST RESULTS**

Temperature ( °C )	22~28
Humidity ( %RH )	50~57
Barometric Pressure ( mbar )	950~1000
EUT	POWER SUPPLY -METAL DRIVER SERIES
M/N	VT-20350
Operating Mode	Full Load
Test Results	PASS

Frequency (MHz)	Polarity	Position	Field Strength (V/m)	Observation	Result
80 ~ 1000	V&H	Front	3	Note	PASS
80 ~ 1000	V&H	Rear	3	Note	PASS
80 ~ 1000	V&H	Left	3	Note	PASS
80 ~ 1000	V&H	Right	3	Note	PASS

**NOTE:** There was no change compared with the initial operation during the test.

## 7.5 ELECTRICAL FAST TRANSIENT (EFT)

### 7.5.1 TEST SPECIFICATION

<b>Basic Standard:</b>	EN 61000-4-4
<b>Test Voltage:</b>	Power Line: 1 kV Signal/Control Line: 0.5 kV
<b>Polarity:</b>	Positive & Negative
<b>Impulse Frequency:</b>	5 kHz
<b>Impulse Wave-shape:</b>	5/50 ns
<b>Burst Duration:</b>	15 ms
<b>Burst Period:</b>	300 ms
<b>Test Duration:</b>	Not less than 1 min.
<b>Performance criterion:</b>	B

### 7.5.2 TEST PROCEDURE

- a) Both positive and negative polarity discharges were applied.
- b) The length of the “hot wire” from the coaxial output of the EFT generator to the terminals on the EUT should not exceed 1 meter.
- c) The duration time of each test sequential was 1 minute.
- d) The transient/burst waveform was in accordance with EN 61000-4-4, 5/50ns.

### 7.5.3 TEST SETUP

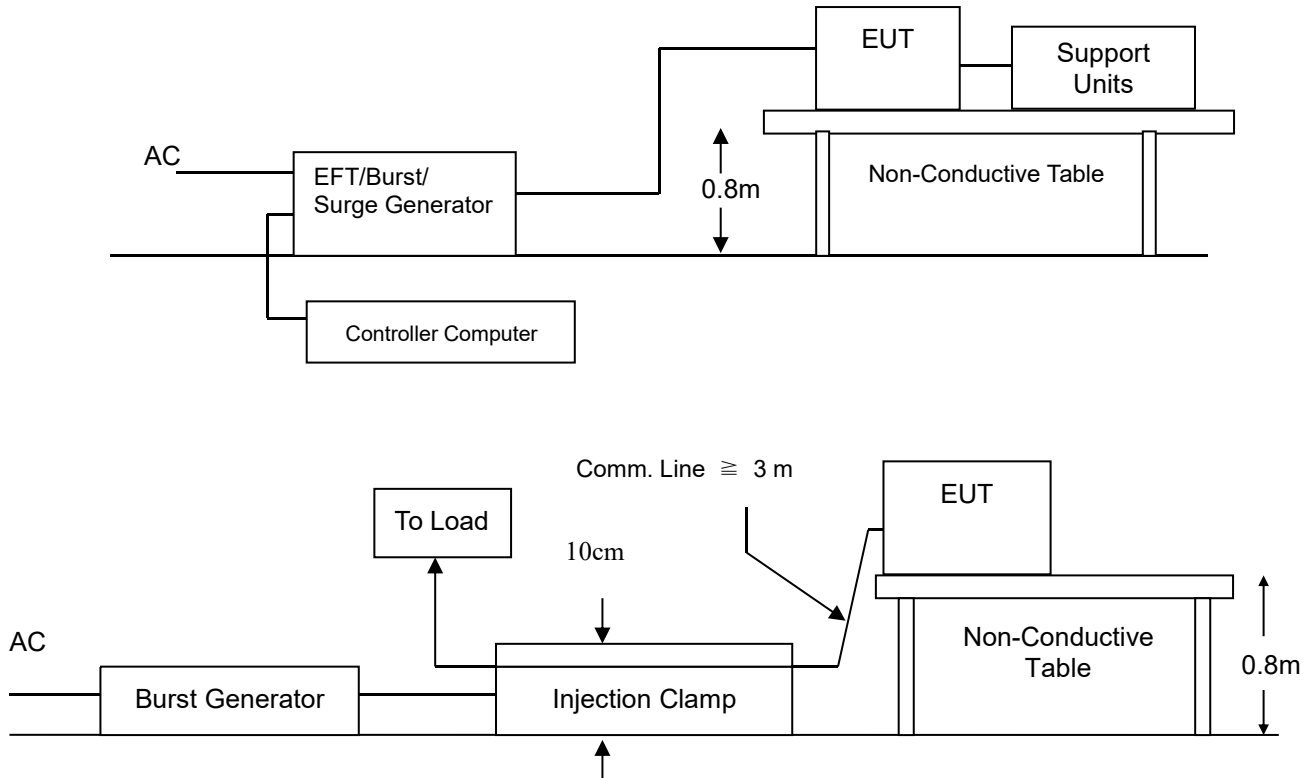

For the actual test configuration, please refer to the related item – Photographs of the Test Configuration.

**NOTE:**

TABLETOP EQUIPMENT

The configuration consisted of a wooden table (0.8m high) standing on the Ground Reference Plane. The GRP consisted of a sheet of aluminum (at least 0.25mm thick and 2.5m square) connected to the protective grounding system. A minimum distance of 0.5m was provided between the EUT and the walls of the laboratory or any other metallic structure.

FLOOR STANDING EQUIPMENT

The EUT installed in a representative system as described in section 7 of IEC 61000-4-4 and its cables, were isolated from the Ground Reference Plane by an insulating support that is 0.1-meter thick. The GRP consisted of a sheet of aluminum (at least 0.25mm thick and 2.5m square) connected to the protective grounding system.

### 7.5.4 TEST RESULTS

Temperature ( °C )	22~28
Humidity ( %RH )	50~57
Barometric Pressure ( mbar )	950~1000
EUT	POWER SUPPLY -METAL DRIVER SERIES
M/N	VT-20350
Operating Mode	Full Load
Test Results	PASS

Test Point	Polarity	Test Level (kV)	Performance Criterion	Observation	Result
L 1	+/-	1	B	Note <input type="checkbox"/> 1 <input checked="" type="checkbox"/> 2	PASS
L 2	+/-	1	B	Note <input type="checkbox"/> 1 <input checked="" type="checkbox"/> 2	PASS
L 1-L 2	+/-	1	B	Note <input type="checkbox"/> 1 <input checked="" type="checkbox"/> 2	PASS
Signal Line	--	--	--	Note <input type="checkbox"/> 1 <input type="checkbox"/> 2	N/A

- NOTE:** 1. There was no change compared with initial operation during the test.  
 2. The loss of function of the EUT during the test and it was recovered by itself operation after the test.

### 7.6 SURGE IMMUNITY TEST

#### 7.6.1 TEST SPECIFICATION

<b>Basic Standard:</b>	EN 61000-4-5
<b>Wave-Shape:</b>	Combination Wave 1.2/50 us Open Circuit Voltage 8/20 us Short Circuit Current
<b>Test Voltage:</b>	Power line ~ line to line: 1 kV; line to ground: 2kV Telecommunication line: 1 kV;
<b>Surge Input/Output:</b>	Power Line: L1-N / N-PE / L1-PE Telecommunication line: T-Ground / R-Ground
<b>Generator Source Impedance:</b>	2 ohm between networks 12 ohm between network and ground
<b>Polarity:</b>	Positive/Negative
<b>Phase Angle:</b>	0 /90 /180 /270
<b>Pulse Repetition Rate:</b>	1 time / min. (maximum)
<b>Number of Tests:</b>	5 positive and 5 negative at selected points
<b>Performance Criterion:</b>	B

### 7.6.2 TEST PROCEDURE

a) For EUT power supply:

The surge is applied to the EUT power supply terminals via the capacitive coupling network. Decoupling networks are required in order to avoid possible adverse effects on equipment not under test that may be powered by the same lines, and to provide sufficient decoupling impedance to the surge wave. The power cord between the EUT and the coupling/decoupling networks was shorter than 2 meters in length.

b) For test applied to unshielded un-symmetrically operated interconnection lines of EUT:

The surge was applied to the lines via the capacitive coupling. The coupling / decoupling networks didn't influence the specified functional conditions of the EUT. The interconnection line between the EUT and the coupling/decoupling networks was shorter than 2 meters in length.

c) For test applied to unshielded symmetrically operated interconnection / telecommunication lines of EUT:

The surge was applied to the lines via gas arrestors coupling. Test levels below the ignition point of the coupling arrester were not specified. The interconnection line between the EUT and the coupling/decoupling networks was shorter than 2 meters in length.

### 7.6.3 TEST SETUP

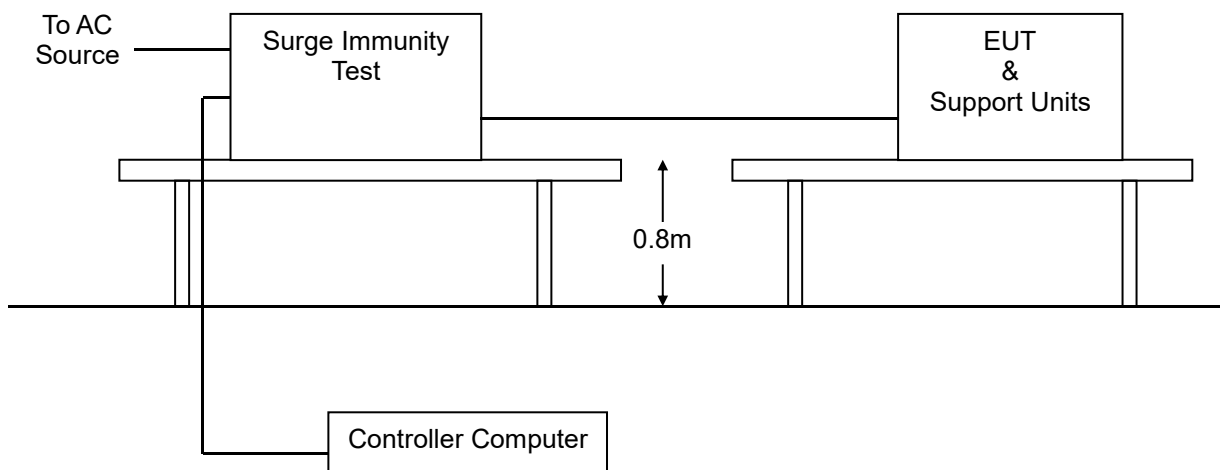

For the actual test configuration, please refer to the related item – Photographs of the Test Configuration.

### 7.6.4 TEST RESULTS

Temperature ( °C )	22~28
Humidity ( %RH )	50~57
Barometric Pressure ( mbar )	950~1000
EUT	POWER SUPPLY -METAL DRIVER SERIES
M/N	VT-20350
Operating Mode	Full Load
Test Results	PASS

Test Point	Polarity	Test Level (kV)	Performance Criterion	Observation	Result
L 1 - L 2	+/-	1	B	Note <input type="checkbox"/> 1 <input checked="" type="checkbox"/> 2	PASS
R - Ground	--	--	--	Note <input type="checkbox"/> 1 <input type="checkbox"/> 2	N/A
T - Ground	--	--	--	Note <input type="checkbox"/> 1 <input type="checkbox"/> 2	N/A

- NOTE:** 1. There was no change compared with initial operation during the test.  
 2. The loss of function of the EUT during the test and it was recovered by itself operation after the test.

## 7.7 CONDUCTED RADIO FREQUENCY DISTURBANCES (CS)

### 7.7.1 TEST SPECIFICATION

<b>Basic Standard:</b>	EN 61000-4-6
<b>Frequency Range:</b>	0.15 MHz ~ 80 MHz
<b>Field Strength:</b>	3 V
<b>Modulation:</b>	1kHz Sine Wave, 80%, AM Modulation
<b>Frequency Step:</b>	1 % of preceding frequency value
<b>Coupled cable:</b>	Power Mains, Shielded
<b>Coupling device:</b>	CDN-M3/2 (2 wires)
<b>Performance criterion:</b>	A

### 7.7.2 TEST PROCEDURE

The EUT shall be tested within its intended operating and climatic conditions.

The test shall be performed with the test generator connected to each of the coupling and decoupling devices in turn, while the other non-excited RF input ports of the coupling devices are terminated by a 50-ohm load resistor.

The frequency range was swept from 150 kHz to 80 MHz, using the signal level established during the setting process and with a disturbance signal of 80 % amplitude. The signal was modulated with a 1 kHz sine wave, pausing to adjust the RF signal level or the switch coupling devices as necessary. The sweep rate was  $1.5 \times 10^{-3}$  decades/s. Where the frequency range is swept incrementally, the step size was 1 % of preceding frequency value from 150 kHz to 80 MHz.

The dwell time at each frequency was less than the time necessary for the EUT to be exercised, and able to respond. Sensitive frequencies such as clock frequency(ies) and harmonics or frequencies of dominant interest, was analyzed separately.

Attempts were made to fully exercise the EUT during testing, and to fully interrogate all exercise modes selected for susceptibility.

### 7.7.3 TEST SETUP

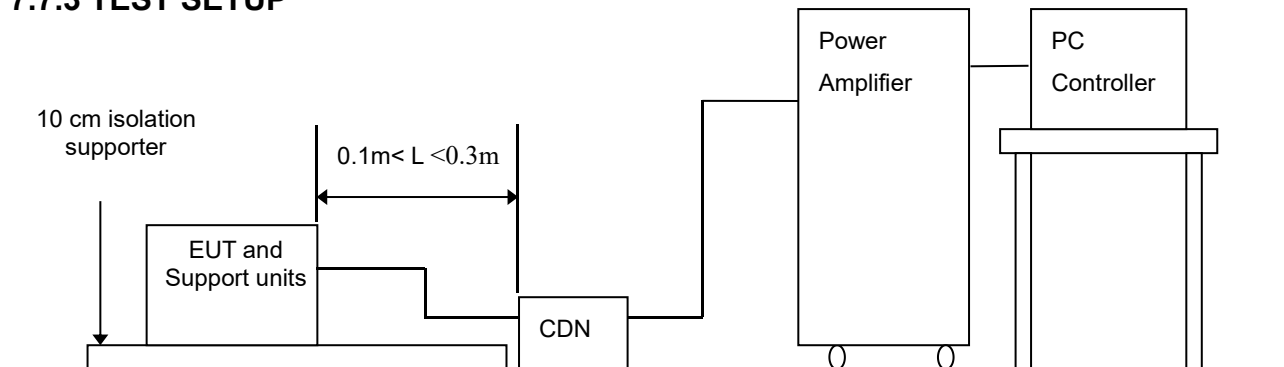

- Note:** 1. The EUT is setup 0.1m above Ground Reference Plane  
 2. The CDNS and / or EM clamp used for real test depends on ports and cables configuration of EUT.

For the actual test configuration, please refer to the related item .

**NOTE:**

TABLE-TOP AND FLOOR-STANDING EQUIPMENT

The equipment to be tested is placed on an insulating support of 0.1 meters height above a ground reference plane. All relevant cables shall be provided with the appropriate coupling and decoupling devices at a distance between 0.1 meters and 0.3 meters from the projected geometry of the EUT on the ground reference plane.

### 7.7.4 TEST RESULTS

Temperature ( °C )	22~28
Humidity ( %RH )	50~57
Barometric Pressure ( mbar )	950~1000
EUT	POWER SUPPLY -METAL DRIVER SERIES
M/N	VT-20350
Operating Mode	Full Load
Test Results	PASS

Frequency Band (MHz)	Field Strength (Vrms)	Injected Position	Injection Method	Performance Criterion	Observation	Result
0.15 ~ 80	3	AC Mains	CDN-M2	A	Note <input checked="" type="checkbox"/> 1 <input type="checkbox"/> 2	PASS
0.15 ~ 80	3	LAN(10m)	--	--	Note <input type="checkbox"/> 1 <input type="checkbox"/> 2	N/A

- NOTE:** 1. There was no change compared with initial operation during the test.  
 2. The loss of function of the EUT during the test and it was recovered by itself operation after the test.  
 3.N/A means to no applicable.



## 7.8 VOLTAGE DIP & VOLTAGE INTERRUPTIONS

### 7.8.1 TEST SPECIFICATION

<b>Basic Standard:</b>	EN 61000-4-11
<b>Test duration time:</b>	Minimum three test events in sequence
<b>Interval between event:</b>	Minimum 10 seconds
<b>Phase Angle:</b>	0 / 45 / 90/ 135/ 180/ 225/ 270/ 315/ 360
<b>Test cycle:</b>	3 times
<b>Performance criterion:</b>	B,C

### 7.8.2 TEST PROCEDURE

1. The EUT and support units were located on a wooden table, 0.8 m away from ground floor.
2. Setting the parameter of tests and then perform the test software of test simulator.
3. Conditions changes to occur at 0 degree crossover point of the voltage waveform.
4. Recording the test result in test record form.

### 7.8.3 TEST SETUP

For the actual test configuration, please refer to the related item – Photographs of the Test Configuration.

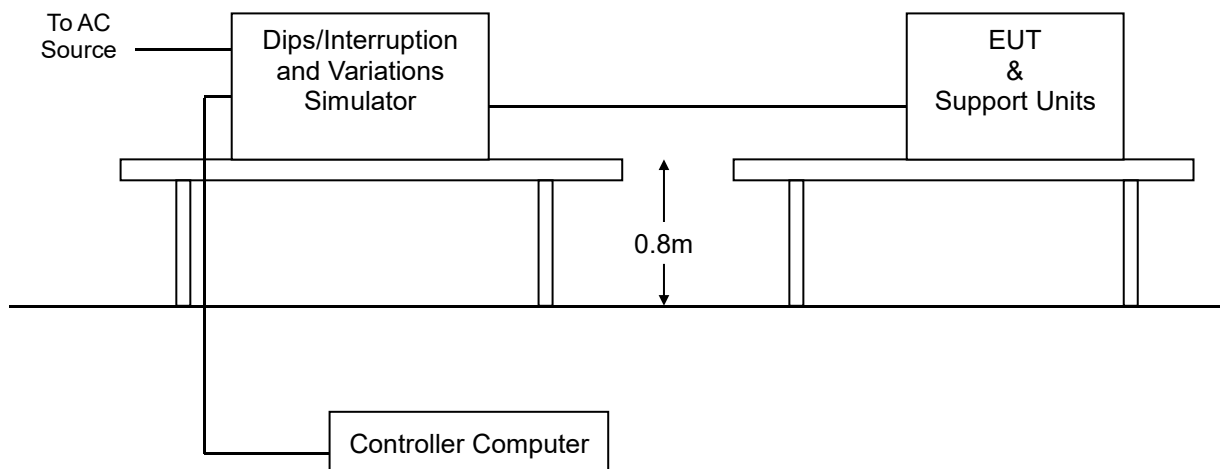

### 7.8.4 TEST RESULTS

Temperature ( °C )	22~28
Humidity ( %RH )	50~57
Barometric Pressure ( mbar )	950~1000
EUT	POWER SUPPLY -METAL DRIVER SERIES
M/N	VT-20350
Operating Mode	Full Load
Test Results	PASS

Voltage (% Reduction)	Duration (Period)	Performance Criterion	Observation	Test Result
95	0.5	<input type="checkbox"/> A <input checked="" type="checkbox"/> B <input type="checkbox"/> C	Note <input type="checkbox"/> 1 <input checked="" type="checkbox"/> 2 <input type="checkbox"/> 3	PASS
30	25	<input type="checkbox"/> A <input type="checkbox"/> B <input checked="" type="checkbox"/> C	Note <input type="checkbox"/> 1 <input type="checkbox"/> 2 <input checked="" type="checkbox"/> 3	PASS
95	250	<input type="checkbox"/> A <input type="checkbox"/> B <input checked="" type="checkbox"/> C	Note <input type="checkbox"/> 1 <input type="checkbox"/> 2 <input checked="" type="checkbox"/> 3	PASS

- NOTE:** 1. There was no change compared with initial operation during and after the test.  
 No unintentional response was found during the test.  
 2. The function stopped during the test, but can be recoverable by itself operation after the test.  
 3. The function stopped during the test, but can be recoverable manually after the test.

## 8. TEST SETUP PHOTOGRAPHS

### CONDUCTED EMISSION TEST



### RADIATED EMISSION TEST

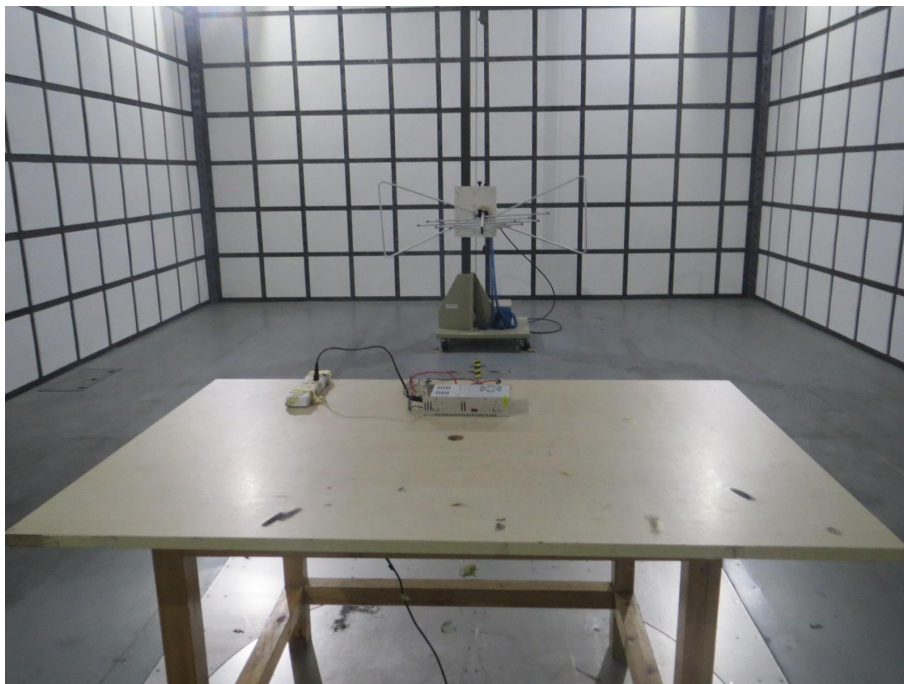

## 9. EUT PHOTOGRAPHS

<p>Photo 1</p> <p>View:</p> <p><input checked="" type="checkbox"/> Front</p> <p><input type="checkbox"/> Rear</p> <p><input type="checkbox"/> Right side</p> <p><input type="checkbox"/> Left side</p> <p><input type="checkbox"/> Top</p> <p><input type="checkbox"/> Bottom</p> <p><input type="checkbox"/> Internal</p>	
--	---

<p>Photo 2</p> <p>View:</p> <p><input type="checkbox"/> Front</p> <p><input checked="" type="checkbox"/> Rear</p> <p><input type="checkbox"/> Right side</p> <p><input type="checkbox"/> Left side</p> <p><input type="checkbox"/> Top</p> <p><input type="checkbox"/> Bottom</p> <p><input type="checkbox"/> Internal</p>	
--	--



Photo 3

View:

- Front
- Rear
- Right side
- Left side
- Top
- Bottom
- Internal

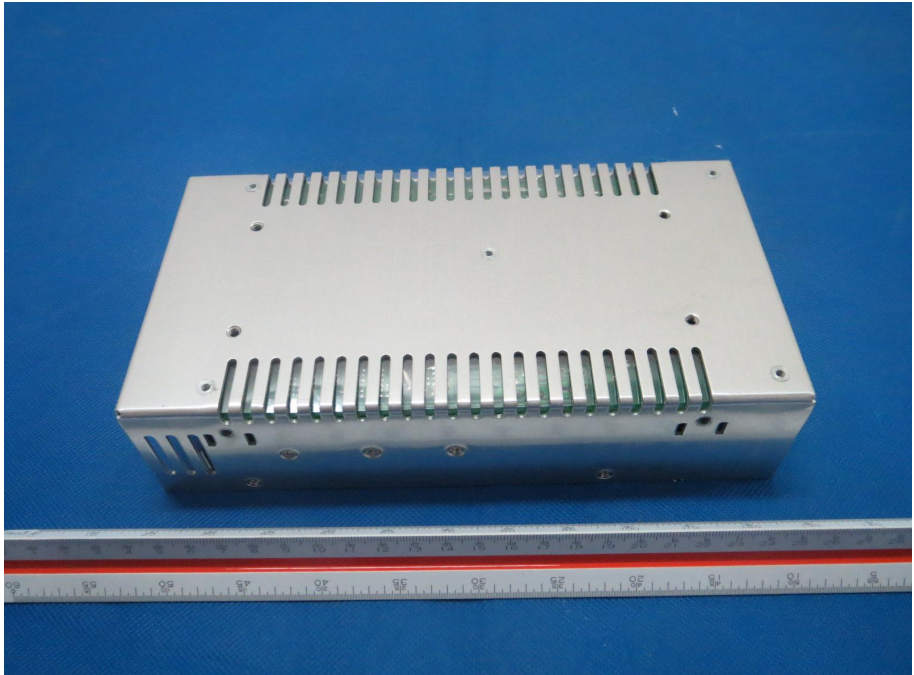

Photo 4

View:

- Front
- Rear
- Right side
- Left side
- Top
- Bottom
- Internal



---END---