

## INSTRUCTION MANUAL

### LED BACKLIT SURFACE MOUNTED PANEL



**05** YEAR  
WARRANTY\*



**PRO**  
SERIES



### TECHNICAL DATA

MODEL	SKU	SHAPE	WATTS	LUMENS	BEAM ANGLE	IP RATING	CRI	BODY TYPE	TOTAL CURRENT	INPUT VOLTAGE	LIFE SPAN	ON/OFF CYCLE	DIMENSION (LxWxH)
VT-60006	104921,104931 104941 78701,78711 78721	ROUND	6W	660Lm	Sphere 360°	IP20	>80	PLASTIC	36mA	AC:220-240 50/60Hz	20000H	>15000	φ121.2x30.6mm
		SQUARE											120.8x120.8x30.7mm
VT-60012	104951, 104961 104971 78751, 78741 78751	ROUND	12W	1200Lm	Sphere 360°	IP20	>80	PLASTIC	71mA	AC:220-240 50/60Hz	20000H	>15000	φ167.4x30.7mm
		SQUARE											167.3x167.3x30.7mm
VT-60018	104981,104991 105001 78761,78771 78781	ROUND	18W	1850Lm	Sphere 360°	IP20	>80	PLASTIC	103mA	AC:220-240 50/60Hz	20000H	>15000	φ215.6x30.8mm
		SQUARE		1980Lm									214x214x31mm
VT-60024	105141,105161 230231 78791,78801 78811	ROUND	24W	2500Lm	Sphere 360°	IP20	>80	PLASTIC	160mA	AC:220-240 50/60Hz	20000H	>15000	φ288.6x31.2mm
		SQUARE		2640Lm									285x285x30.7mm

'This product contains a light source of energy efficiency class <F/E>', where <F/E> shall be replaced by the energy efficiency class of the contained light source.

### INTRODUCTION & WARRANTY

Thank you for selecting and buying V-TAC product. V-TAC will serve you the best. Please read these instructions carefully before starting the installation and keep this manual handy for future reference. If you have any another query, please contact our dealer or local vendor from whom you have purchased the product. They are trained and ready to serve you at the best. The warranty is valid for 5 years from the date of purchase. The warranty does not apply to damage caused by incorrect installation or abnormal wear and tear. The company gives no warranty against damage to any surface due to incorrect removal and installation of the product. The products are suitable for 10-12 Hours Daily operation. Usage of product for 24 Hours a day would void the warranty. This product is warranted for manufacturing defects only.

### WARNING

- Please make sure to turn off the power before starting the installation.
- Installation must be performed by a certified person.
- If the external flexible cable or cord of this luminaire is damaged, it shall be exclusively replaced by the manufacturer or his service agent or a similar qualified person in order to avoid a hazard.
- Method of attachment of the cable or cord such that any replacement can only be made by the manufacturer, his service agent or similar qualified person.
- For Indoor use only.

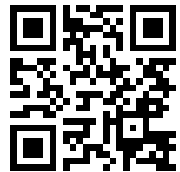

**MULTI-LANGUAGE  
MANUAL QR CODE**

Please scan the QR code to access the manual in multiple languages.



This marking indicates that this product should not be disposed of with other household wastes.



Caution, risk of electric shock.

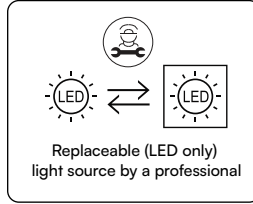

Points de collecte sur [www.quefairedemesdechets.fr](http://www.quefairedemesdechets.fr)  
Privilégiez la réparation ou le don de votre appareil !

## ATTENTION!

Do not look directly at LED light beam. Product can only be supplied by rated voltage or voltage within the range provided. It's forbidden to use the product with damaged protective cover. Product must not be used in unfavorable conditions, e.g. dust, water, moisture, vibrations, explosive air atmosphere, fumes, or chemical fumes, etc. In the area of strong electromagnetic interference, the functioning of the product may be disrupted.

## USAGE GUIDELINES/MAINTENANCE

Any maintenance work must be performed when the power supply is cut off and the product has cooled down. Clean only with soft and dry cloths. Do not use chemical detergents. Do not cover the product. Ensure free air access. Product may heat up to a higher temperature.

## MOUNTING

Read the manual before mounting. Mounting should be performed by a qualified electrician. Exercise caution. Product has a protective contact /terminal. Failure to connect the protective lead may lead to electric shock. Mounting diagram: see pictures. Check for proper mechanical fastening and connection to electrical power prior to first use.

## SURFACE PANEL INSTALLATION DIAGRAM

### WIRING DIAGRAM

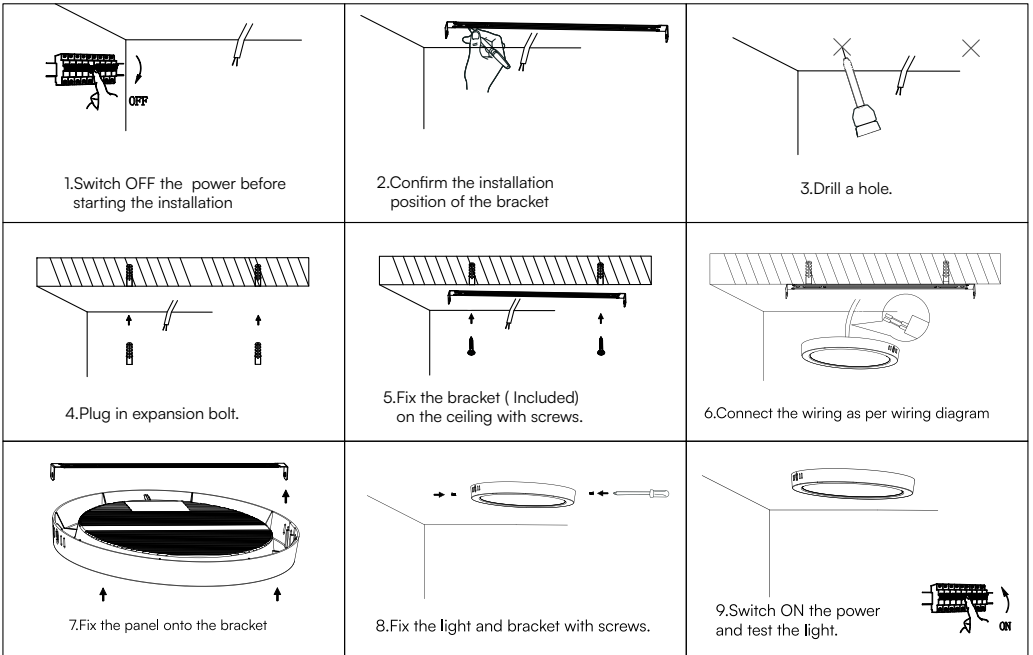

## DISASSEMBLY DIAGRAM

(For Market surveillance team only)

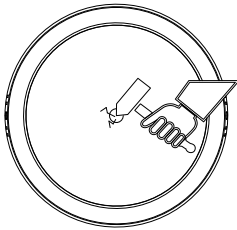

1. Power off, tap the central area of the diffusion plate with a pointed tool, and take out the cracked diffusion plate

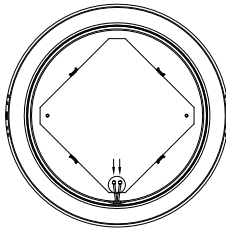

2. Remove the power wire from the plug terminal

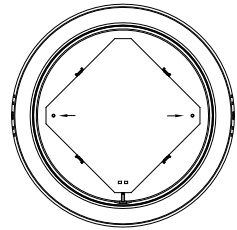

3. If there is no hot melt column in the lamp body or the hot melt column is not hot melt, this step will be adjusted without treatment. If the hot-melt column has been fused to fix the aluminum substrate, cut the hot-melt part of the hot-melt point with diagonal pliers.

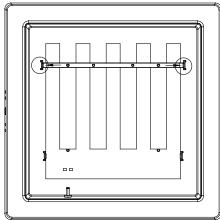

4. Press the buckle outwards, remove the aluminum substrate pressing strip from the bayonet, and remove the pressing strip. This step is only required for 24W panel light, other items are not required.

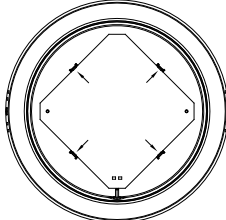

5. Press the buckle outwards, remove the aluminum substrate from the buckle, and remove the light source board.

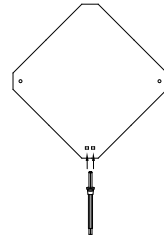

6. Take out two-cord cable (wire diameter 18-22AWG) and insert it into the plug-in terminal. Connect the external power supply for testing.

Note: Light source removal will void the warranty

RoHS



UK  
CA



IN CASE OF ANY QUERY/ISSUE WITH THE PRODUCT, PLEASE REACH OUT TO US AT: SUPPORT@V-TAC.EU  
FOR MORE PRODUCTS RANGE, INQUIRY PLEASE CONTACT OUR DISTRIBUTOR OR NEAREST DEALERS. V-TAC  
EUROPE LTD. BULGARIA, PLOVDIV 4000, BUL.L.KARAVELOW 9B

## РЪКОВОДСТВО ЗА УПОТРЕБА

### ПАНЕЛ ЗА ПОВЪРХНОСТЕН МОНТАЖ С LED ПОДСВЕТКА



#### ТЕХНИЧЕСКИ ДАННИ

МОДЕЛ	SKU	SHAPE	WATTS	LUMENS	ЪЪЛ НА ЛЪЧА	IP РЕЙТИНГ	CRI	ТИП НА ТЪЛОТО	ОБЩО ЕЛЪГАРСКО	ВХОДНО НАПРЕЖЕНИЕ	ПРОДЪЛЖИТЕЛНОСТ НА	ЦИКЪЛ НА ВКЛЮЧВАНЕ/ИЗКЛЮЧВАНЕ	РАЗМЕРИ (LxWxH)
VT-60006	104901, 104931	КРЪГ	6W	660Lm	Сфера 360°	IP20	>80	PLASTIC	36mA	AC: 220-240 50/60Hz	20000H	>15000	φ121.2x30.6mm
	78701, 78711, 78721	КВАДРАТ											120,8x120,8x30,7 мм
VT-60012	104951, 104961	КРЪГ	12W	1200Lm	Сфера 360°	IP20	>80	PLASTIC	71mA	AC: 220-240 50/60Hz	20000H	>15000	φ167.4x30.7mm
	78731, 78741, 78751	КВАДРАТ											167,3x167,3x30,7 мм
VT-60018	104981, 104991	КРЪГ	18W	1850Lm	Сфера 360°	IP20	>80	PLASTIC	103mA	AC: 220-240 50/60Hz	20000H	>15000	φ215.6x30.8mm
	105001, 78761, 78771, 78781	КВАДРАТ		1980Lm									214x214x31mm
VT-60024	105141, 105161	КРЪГ	24W	2500Lm	Сфера 360°	IP20	>80	PLASTIC	160mA	AC: 220-240 50/60Hz	20000H	>15000	φ288.6x31.2mm
	105201, 78791, 78801, 78811	КВАДРАТ		2640Lm									285x285x30,7 мм

"Този продукт съдържа светлинен източник с клас на енергийна ефективност <F/E>", където <F/E> се заменя с класа на енергийна ефективност на съдържащата се светлинен източник.

#### ВЪВЕДЕНИЕ И ГАРАНЦИЯ

Благодарим ви, че избрахте и закупихте продукт на V-TAC. V-TAC ще ви служи по най-добрия начин. Моля, прочетете внимателно тези инструкции, преди да започнете инсталацията, и пазете това ръководство под ръка за бъдещи справки. Ако имате някакви други въпроси, моля, свържете се с нашия дилър или с местния продавач, от когото сте закупили продукта. Те са обучени и са готови да ви обслужат по най-добрия начин. Гаранцията е валидна за срок от 5 години от датата на закупуване. Гаранцията не важи за повреди, причинени от неправилен монтаж или необичайно износване. Фирмата не дава гаранция за повреди на повърхности, дължащи се на неправилно демонтиране и инсталиране на продукта. Продуктите са подходящи за 10-12-часова ежедневна работа. Използването на продукта в продължение на 24 часа на ден води до отпадане на гаранцията. Този продукт има гаранция само за производствени дефекти.

#### ПРЕДУПРЕЖДЕНИЕ

- Моля, уверете се, че сте изключили захранването, преди да започнете монтажа.
- Монтажът трябва да се извърши от сертифицирано лице.
- Ако външният гъвкав кабел или шнур на това осветително тяло е повреден, той трябва да бъде подменен изключително от производителя, неговия сервизен агент или подобно квалифицирано лице, за да се избегне опасност.
- Метод на закрепване на кабела или шнура, така че всяка замяна да може да се извърши само от производителя, неговия сервизен агент или подобно квалифицирано лице.
- Само за употреба на закрито.



Тази маркировка показва, че този продукт не трябва да се изхвърля заедно с други битови отпадъци.



Внимание, риск от токов удар.

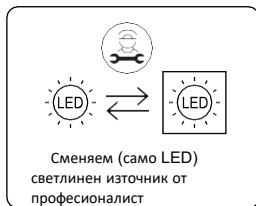

Points de collecte sur [www.quefairemesdechets.fr](http://www.quefairemesdechets.fr)  
Privilégiez la réparation ou le don de votre appareil !

## ВНИМАНИЕ!

Не гледайте директно към светлинния лъч на светодиода. Продуктът може да бъде захранван само с номинално напрежение или с напрежение в рамките на предоставения диапазон. Забранено е използването на продукта с повреден защитен капак. Продуктът не трябва да се използва при неблагоприятни условия, напр. прах, вода, влага, вибрации, експлозивна въздушна атмосфера, изпарения или химически изпарения и др. В зона със силни електромагнитни смущения функционирането на продукта може да бъде нарушено.

## НАСОКИ ЗА ИЗПОЛЗВАНЕ/ПОДДРЪЖКА

Всички дейности по поддръжката трябва да се извършват, когато захранването е прекъснато и продуктът е изстинал. Почиствайте само с меки и сухи кърпи. Не използвайте химически почистващи препарати. Не покривайте продукта. Осигурете свободен достъп на въздух. Продуктът може да се нагрее до по-висока температура.

## МОНТИРАНЕ

Прочетете ръководството за употреба преди монтажа. Монтажът трябва да се извърши от квалифициран електротехник. Бъдете внимателни. Продуктът е снабден със защитен контакт /терминал. Несвързването на защитния проводник може да доведе до токов удар. Схема за монтаж: вижте снимките. Проверете за правилното механично

закрепване и свързване към електрическата мрежа преди първата употреба.

### WIRING DIAGRAM



## СХЕМА ЗА ИНСТАЛИРАНЕ НА ПОВЪРХНОСТЕН ПАНЕЛ

<p>1. Изключете захранването, преди да започнете</p>	<p>2. Потвърдете позицията на монтаж на скобата</p>	<p>3. Пробийте</p>
<p>4. Plug в разширителен</p>	<p>5. Закрепете скобата ( в комплекта) на тавана с</p>	<p>6. Свържете окаеляването съгласно</p>
<p>7. Закрепете панела върху скобата</p>	<p>8. Закрепете светлината и скобата с винтове</p>	<p>9. Включете захранването и тествайте светлината.</p>

## СХЕМА ЗА РАЗГЛОБЯВАНЕ

(Само за екипа за наблюдение на пазара)

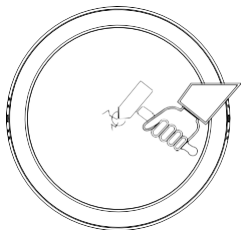

1. Изключете захранването, докоснете централната област на дифузионната плоча с остър инструмент и извадете напуканата дифузионна плоча

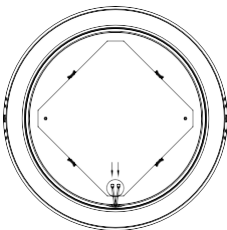

2. Премахнете захранващия проводник от клемата на щепсела

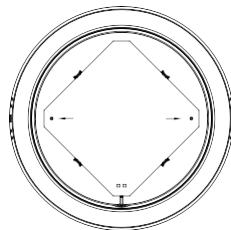

3. Ако в тялото на лампата няма колона за горещо разтопяване или колоната за горещо разтопяване не е гореща, тази стъпка ще бъде хоризорирана

Ако колоната за горещо топене е била стопена, за да се фиксира алуминиевата основа, отрежете частта на горещото топене на точката за горещо топене с диагонални клещи.

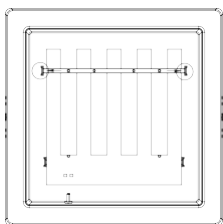

4. Натиснете ключалката навън, отстранете притискащата лента на алуминиевия субстрат от байонета и отстранете притискащата лента. Тази стъпка е необходима само за 24W панелна светлина, други елементи не са необходими.

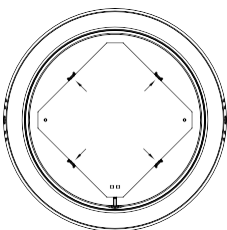

5. Натиснете ключалката навън, отстранете алуминиевата подложка от ключалката и извадете платката на светлинния източник.

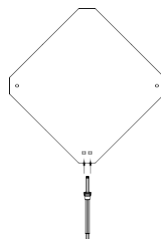

6. Извадете двужилен кабел (диаметър на проводника 18-22AWG) и го поставете в клемата за включване. Свържете външното захранване за тестване.

Забележка: Отстраняването на светлинния източник води до анулиране на гаранцията.

RoHS



UK  
CA



В СЛУЧАЙ НА ЗАПИТВАНЕ/ПРОБЛЕМ С ПРОДУКТА, МОЛЯ, СВЪРЖЕТЕ СЕ С НАС НА: [SUPPORT@V-TAC.EU](mailto:SUPPORT@V-TAC.EU) ЗА ПОВЕЧЕ ПРОДУКТОВА ГАМА, ЗАПИТВАНЕ, МОЛЯ, СВЪРЖЕТЕ СЕ С НАШИЯ ДИСТРИБУТОР ИЛИ НАЙ-БЛИЗКИТЕ ДИЛЪРИ. V-TAC EUROPE LTD. БЪЛГАРИЯ, ПЛОВДИВ 4000, БУЛ.Л.КАРАВЕЛОВ 9Б

## UPUTE ZA UPORABU

POVRŠINSKI MONTIRANI PANEL S LED POZADINSKIM SVJETLJEM

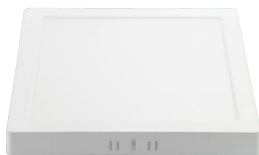

### TEHNIČKI PODACI

MODEL	SKU	OBLIK	WATTI	LUMENI	Kut svjetlosnog snopa	IP OCJENA	CRI	Tip tijela	Ulazna struja	Ulazni napon	Životni vijek	Ciklus uključivanja/isključivanja	Dimenzija (DxŠxV)
VT-60006	104921,104931 104941 78701,78711 78721	Krug	6W	660Lm	Sfera 360°	IP20	>80	plastični	36mA	AC:220-240 50/60Hz	20000H	>15000	φ121.2x30.6mm
		Kvadrat											120.8x120.8x30.7mm
VT-60012	104951, 104961 104971 78731, 78741 78751	Krug	12W	1200Lm	Sfera 360°	IP20	>80	plastični	71mA	AC:220-240 50/60Hz	20000H	>15000	φ167.4x30.7mm
		Kvadrat											167.3x167.3x30.7mm
VT-60018	104981,104991 105001 78761,78771 78781	Krug	18W	1850Lm	Sfera 360°	IP20	>80	plastični	103mA	AC:220-240 50/60Hz	20000H	>15000	φ215.6x30.8mm
		Kvadrat		1980Lm									214x214x31mm
VT-60024	105141,105161 230231 78791,78801 78811	Krug	24W	2500Lm	Sfera 360°	IP20	>80	plastični	160mA	AC:220-240 50/60Hz	20000H	>15000	φ288.6x31.2mm
		Kvadrat		2640Lm									285x285x30.7mm

„Ovaj proizvod sadrži izvor svjetlosti klase energetske učinkovitosti <F/E>”, gdje se <F/E> mora zamijeniti klasom energetske učinkovitosti sadržanog izvora svjetlosti.

### UVOD & JAMSTVO

Hvala što ste odabrali i kupili V-TAC proizvod. V-TAC će vam poslužiti najbolje. Pažljivo pročitajte ove upute prije početka instalacije i držite ovaj priručnik pri ruci za buduće potrebe. Ako imate bilo kakvih dodatnih pitanja, obratite se našem trgovcu ili lokalnom prodavaču od kojeg ste kupili proizvod. Oni su obučeni i spremni poslužiti vas na najbolji način. Jamstvo vrijedi 5 godina od datuma kupnje. Jamstvo se ne odnosi na oštećenja uzrokovana neispravnom ugradnjom ili nenormalnim trošenjem. Tvrtka ne daje jamstvo protiv oštećenja bilo koje površine uslijed nepravilnog uklanjanja i postavljanja proizvoda. Proizvodi su prikladni za 10-12 sati dnevnog rada. Korištenje proizvoda 24 sata dnevno poništilo bi jamstvo. Ovaj proizvod ima jamstvo samo za greške nastale u proizvodnji.

### UPOZORENJE

- Provjerite jeste li isključili napajanje prije početka instalacije.
- Instalaciju mora izvršiti ovlaštena osoba.
- Ako je vanjski fleksibilni kabel ili kabel ove svjetiljke oštećen, zamijenit će ga isključivo proizvođač ili njegov serviser ili slična kvalificirana osoba kako bi se izbjegla opasnost.
- Način pričvršćivanja kabela ili kabela tako da bilo kakvu zamjenu može izvršiti samo proizvođač, njegov serviser ili slična kvalificirana osoba.
- Samo za unutarnju upotrebu.



Ova oznaka označava da se ovaj proizvod ne smije odlagati s drugim kućnim otpadom.



Oprez, opasnost od strujnog udara.

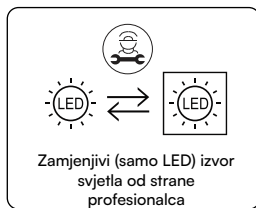

Zamjenjivi (samo LED) izvor svjetla od strane profesionalca



Points de collecte sur [www.quefairedemesdechets.fr](http://www.quefairedemesdechets.fr)  
Privilégiez la réparation ou le don de votre appareil !

## PAŽNJA!

Ne gledajte izravno u LED svjetlosni snop. Proizvod se može napajati samo nazivnim naponom ili naponom unutar navedenog raspona. Zabranjeno je koristiti proizvod s oštećenim zaštitnim poklopcem. Proizvod se ne smije koristiti u nepovoljnim uvjetima, npr. prašinu, vodu, vlagu, vibracije, eksplozivnu zračnu atmosferu, pare ili kemijske pare, itd. U području jakih elektromagnetskih smetnji, rad proizvoda može biti poremećen.

## SMJERNICE ZA KORIŠTENJE/ODRŽAVANJE

Svi radovi na održavanju moraju se izvoditi kada je napajanje prekinuto i proizvod se ohladio. Čistite samo mekim i suhim krpama. Nemojte koristiti kemijske deterdente. Nemojte prekrivati proizvod. Osigurajte slobodan pristup zraku. Proizvod se može zagrijati na višu temperaturu.

## MONTAŽA

Pročitajte priručnik prije montaže. Montažu treba izvesti kvalificirani električar. Budite oprezni. Proizvod ima zaštitni kontakt/terminal. Nespojivanje zaštitnog kabela može dovesti do strujnog udara. Dijagram montaže: vidi slike. Provjerite ispravan mehanički pričvršćivanje i spajanje na električnu mrežu prije prve uporabe.

## DIJAGRAM POSTAVLJANJA POVRŠINSKE PLOČE

### WIRING DIAGRAM



<p>1. Prije početka instalacije ISKLJUČITE napajanje</p>	<p>2. Potvrdite položaj ugradnje nosača</p>	<p>3. Izbušite rupu.</p>
<p>4. Umetnite ekspanzijski vijak.</p>	<p>5. Pričvrstite nosač (uključen) na strop vijcima.</p>	<p>6. Spojite ožičenje prema dijagramu ožičenja.</p>
<p>7. Pričvrstite ploču na nosač.</p>	<p>8. Pričvrstite svjetlo i nosač vijcima.</p>	<p>9. Uključite napajanje i testirajte svjetlo.</p>



## DIJAGRAM RASTAVLJANJA

(Samo za tim za nadzor tržišta)

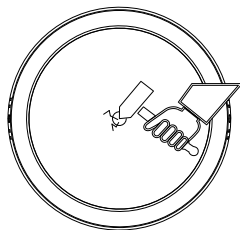

1. Isključite napajanje, dodirnite središnje područje difuzijske ploče šiljastim alatom i izvadite napuknutu difuzijsku ploču

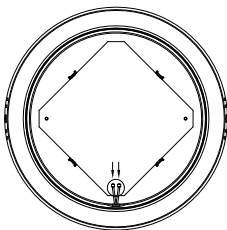

2. Uklonite kabel za napajanje iz terminala utikača

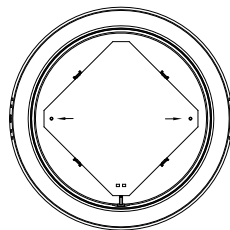

3. Ako u tijelu žarulje nema stupca vruće taljive tvari ili stupac vruće taljive tvari nije vruće taljive, ovaj će se korak prilagoditi bez tretmana. Ako je stupac vruće taljive tvari spojen za fiksiranje aluminijske podloge, odrežite vruću rastopite dio točke taljenja dijagonalnim kiještima.

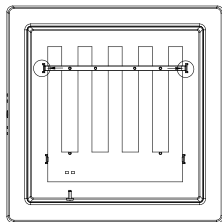

4. Pritisnite kopču prema van, uklonite traku za pritiskanje aluminijske podloge s bajuneta i uklonite traku za pritiskanje. Ovaj korak je potreban samo za rasvjetnu ploču od 24 W, ostale stavke nisu potrebne.

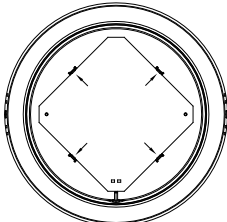

5. Pritisnite kopču prema van, uklonite aluminijsku podlogu s kopče i uklonite ploču izvora svjetla.

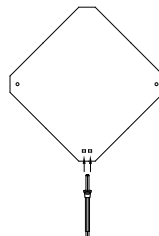

6. Izvadite dvožilni kabel (promjer žice 18-22AWG) i umetnite ga u utičnicu. Spojite vanjsko napajanje za testiranje.

Napomena: Uklanjanje izvora svjetla poništiti će jamstvo



U SLUČAJU BILO KAKVOG UPITA/PROBLEMA S PROIZVODOM, OBRATITE NAM SE NA: SUPPORT@V-TAC.EU  
ZA VIŠE PROIZVODA, UPIT MOLIMO DA KONTAKTIRATE NAŠEG DISTRIBUTERA ILI NAJBЛИŽEG TRGOVCA. V-TAC EUROPE LTD. BUGARSKA, PLOVDIV 4000, BUL.L.KARAVELOW 9B

## NÁVOD K POUŽITÍ

### PANEL S LED PODSVÍCENÍM PRO POVRCHOVOU MONTÁŽ



### TECHNICKÉ ÚDAJE

MODEL	SKU	SHAPE	WATTS	LUMENS	ÚHEL PAPSŘ KU	IP RATING	CRI	TYP TĚLA	CELKEM BĚŽNÝ	VSTUP NÍ NAPĚTÍ	DĚLKA ŽIVOT	CYKLUS ZAPNUTÍ /VYPNUTÍ	ROZMĚRY (DxŠxV)
VT-60006	104921,104931 104941 78701,78711 78721	ROUND	6W	660Lm	Sféra 360°	IP20	>80	PLASTOVÉ	36mA	Střídavý proud: 220-240 50/60Hz	20000H	>15000	φ121,2x30,6 mm
		SQUARE											120,8x120,8x30,7 mm
VT-60012	104951, 104961 104971 78731, 78741 78751	ROUND	12W	1200Lm	Sféra 360°	IP20	>80	PLASTOVÉ	71mA	Střídavý proud: 220-240 50/60Hz	20000H	>15000	φ167,4x30,7 mm
		SQUARE											167,3x167,3x30,7 mm
VT-60018	104981,104991 105001 78761,78771 78781	ROUND	18W	1850Lm	Sféra 360°	IP20	>80	PLASTOVÉ	103mA	Střídavý proud: 220-240 50/60Hz	20000H	>15000	φ215,6x30,8 mm
		SQUARE		1980Lm									214x214x31mm
VT-60024	105141,105161 230231 78781,78801 78811	ROUND	24W	2500Lm	Sféra 360°	IP20	>80	PLASTOVÉ	160 mA	Střídavý proud: 220-240 50/60Hz	20000H	>15000	φ288,6x31,2 mm
		SQUARE		2640Lm									285x285x30,7 mm

"Tento výrobek obsahuje zdroj světla třídy energetické účinnosti <F/E>", kde <F/E> se nahradí třídou energetické účinnosti osazeného zdroje světla.

### ÚVOD A ZÁRUKA

Děkujeme, že jste si vybrali a zakoupili produkt V-TAC. V-TAC vám bude sloužit co nejlépe. Před zahájením instalace si prosím pečlivě přečtete tyto pokyny a uschovejte si tento návod pro budoucí použití. V případě dalších dotazů se obraťte na naše prodejce nebo místního prodejce, od kterého jste výrobek zakoupili. Jsou vyškoleni a připraveni vám co nejlépe posloužit. Záruka je platná po dobu 5 let od data zakoupení. Záruka se nevztahuje na poškození způsobené nesprávnou instalací nebo abnormálním opotřebením. Společnost neposkytuje záruku na poškození jakéhokoli povrchu v důsledku nesprávné demontáže a instalace výrobku. Výrobky jsou vhodné pro 10-12 hodin denního provozu. Používání výrobku po dobu 24 hodin denně by znamenalo ztrátu záruky. Na tento výrobek se vztahuje záruka pouze na výrobní vady.

### VAROVÁNÍ

- Před zahájením instalace nezapomeňte vypnout napájení.
- Instalaci musí provádět certifikovaná osoba.
- Pokud dojde k poškození vnějšího ohebného kabelu nebo šňůry tohoto svítidla, musí být vyměněn výhradně výrobcem nebo jeho servisním zástupcem nebo podobně kvalifikovanou osobou, aby se předešlo nebezpečí.
- Způsob upevnění kabelu nebo šňůry takový, že výměnu může provést pouze výrobce, jeho servisní zástupce nebo podobně kvalifikovaná osoba.
- Pouze pro vnitřní použití.



Toto označení znamená, že tento výrobek by neměl být likvidován společně s ostatním domovním odpadem.



Pozor, nebezpečí úrazu elektrickým proudem.

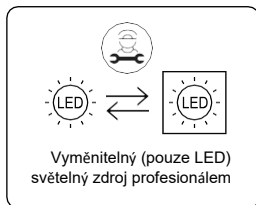

Points de collecte sur [www.quefairemedechets.fr](http://www.quefairemedechets.fr)  
Privilégiez la réparation ou le don de votre appareil !

## POZOR!

Neřívejte se přímo na světelný paprsek LED. Výrobek může být napájen pouze jmenovitým napětím nebo napětím v uvedeném rozsahu. Je zakázáno používat výrobek s poškozeným ochranným krytem. Výrobek se nesmí používat v nepříznivých podmínkách, např. v prachu, vodě, vlhkosti, vibracích, výbušném ovzduší, výparech nebo chemických výparech apod. V oblasti silného elektromagnetického rušení může dojít k narušení funkce výrobku.

## POKYNY PRO POUŽÍVÁNÍ/ÚDRŽBU

Veškeré údržbářské práce se musí provádět po odpojení napájení a v y c h l a d n u t í výrobku. Čistěte pouze měkkými a suchými utěrkami. Nepoužívejte chemické čisticí prostředky. Výrobek nezakrývejte. Zajistěte volný přístup vzduchu. Výrobek se může zahřát na vyšší teplotu.

## MONTÁŽ

Před montáží si přečtěte příručku. Montáž by měl provádět kvalifikovaný elektrikář. Dbejte zvýšené opatnosti. Výrobek je vybaven ochranným kontaktem /koncovkou. Nepřipojení ochranného vodiče může vést k úrazu elektrickým proudem. Montážní schéma: viz obrázky. Zkontrolujte správnou

upevnění a připojení k elektrické síti před prvním použitím.

### WIRING DIAGRAM

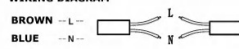

## INSTALAČNÍ SCHÉMA POVRCHOVÉHO PANELU

<p>1. Před zahájením instalace vypněte napájení</p>	<p>2. Potvrďte instalační polohu držáku</p>	<p>3. Vyvrtejte</p>
<p>4. Plug in expansion bolt.</p>	<p>5. Připevněte držák ( je součástí dodávky) ke</p>	<p>6. Zapojte kabeláž podle schématu zapojení</p>
<p>7. Připevněte panel na držák</p>	<p>8. Připevněte světlo a držák pomocí</p>	<p>9. Zapněte napájení a vyzkoušejte světlo.</p>

## DEMONTÁŽNÍ SCHÉMA

(Pouze pro tým pro dohled nad trhem)

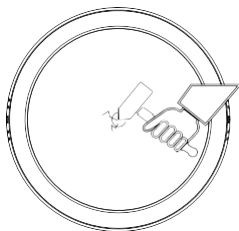

1. Vypněte napájení, špičatým nástrojem poklepejte na střední část difuzní desky a vyjměte prasklou difuzní desku.

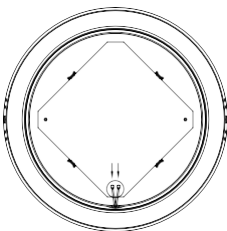

2. Odpojte napájecí vodič od zástrčkové svorky

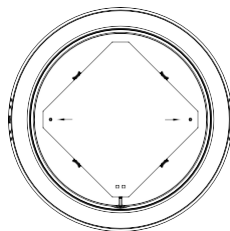

3. Pokud v tělese lampy není žádný sloupec horké taveniny nebo sloupec horké taveniny není horký, tento krok bude upraven.

Pokud by byl sloupek tavné pistolí roztaven pro upevnění hliníkového podkladu, odřízněte část hrotu tavné pistolí pomocí diagonálních kleští.

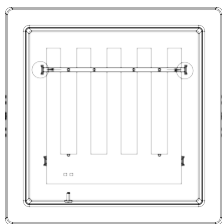

4. Stiskněte sponu směrem ven, odstraňte přitlačnou lištu hliníkového substrátu z bajonetu a odstraňte přitlačnou lištu. Tento krok je nutný pouze pro 24W panelové světlo, ostatní položky nejsou nutné.

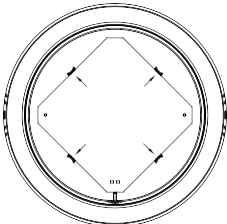

5. Stiskněte sponu směrem ven, odstraňte hliníkový substrát ze spony a vyjměte desku světelného zdroje.

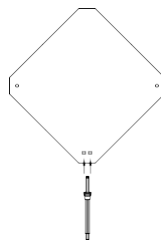

6. Vyjměte dvoušňůrový kabel (průměr drátu 18-22AWG) a vložte jej do zásuvné svorky. Připojte externí zdroj napájení pro testování.

Poznámka: Odstraněním světelného zdroje zaniká záruka.



V PŘÍPADĚ JAKÉHOKOLI DOTAZU NEBO PROBLÉMU S PRODUKTEM SE NA NÁS OBRAŤTE NA: PRO VÍCE INFORMACÍ O SORTIMENTU SE PROSÍM OBRAŤTE NA NAŠEHO DISTRIBUTORA NEBO NEJBLIŽŠÍ PRODEJCE. V-TAC EUROPE LTD. BULHARSKO, PLOVDIV 4000, BUL.L.KARAVELOW 9B

## MANUEL D'INSTRUCTIONS

### PANNEAU DE SURFACE RÉTRO-ÉCLAIRÉ PAR LED



### DONNÉES TECHNIQUES

MODÈLE	SKU	FORME	WATTS	LUMENS	ANGLE DU FAISCEAU	NOTE P	CRI	TYPE DE CORPS	TOTAL COURANT	TENSION D'ENTRÉE	DURÉE DEVIE	CYCLE MARCHÉ/ARRÊT	DIMENSIONS (LxLxH)
VT-60006	104921,104931	ROND	6W	660Lm	Sphère 360	IP20	>80	PLASTIQUE	36mA	AC:220-240 50/60Hz	20000H	>15000	φ121.2x30.6mm
	104941 78701,78711 78721	CARRÉ											120,8x120,8x30,7mm
VT-60012	104951, 104961	ROND	12W	1200Lm	Sphère 360	IP20	>80	PLASTIQUE	72mA	AC:220-240 50/60Hz	20000H	>15000	φ167.4x30.7mm
	104971 78731, 78741 78751	CARRÉ											167,3x167,3x30,7mm
VT-60018	104981,104991	ROND	18W	1850Lm	Sphère 360	IP20	>80	PLASTIQUE	103mA	AC:220-240 50/60Hz	20000H	>15000	φ215.6x30.8mm
	105001 78761,78771 78781	CARRÉ		1980Lm									214x214x31mm
VT-60024	105141,105161	ROND	24W	2500Lm	Sphère 360	IP20	>80	PLASTIQUE	160mA	AC:220-240 50/60Hz	20000H	>15000	φ288.6x31.2mm
	220221 78791,78801 78811	CARRÉ		2640Lm									285x285x30,7mm

Ce produit contient une source lumineuse de classe d'efficacité énergétique <F/E>", où <F/E> est remplacé par la classe d'efficacité énergétique de la source lumineuse contenue.

### INTRODUCTION ET GARANTIE

Merci d'avoir choisi et acheté un produit V-TAC. V-TAC vous servira au mieux. Veuillez lire attentivement ces instructions avant de commencer l'installation et conservez ce manuel à portée de main pour pouvoir vous y référer ultérieurement. Si vous avez d'autres questions, veuillez contacter notre revendeur ou le vendeur local auprès duquel vous avez acheté le produit. Ils sont formés et prêts à vous servir au mieux. La garantie est valable pendant 5 ans à compter de la date d'achat. La garantie ne s'applique pas aux dommages causés par une installation incorrecte ou une usure anormale. L'entreprise ne garantit pas les dommages causés à toute surface par un démontage et une installation incorrects du produit. Les produits conviennent pour un fonctionnement quotidien de 10 à 12 heures. L'utilisation du produit pendant 24 heures par jour annule la garantie. Ce produit est garanti pour les défauts de fabrication uniquement.

### AVERTISSEMENT

- Veuillez à couper l'électricité avant de commencer l'installation.
- L'installation doit être effectuée par une personne certifiée.
- Si le câble ou le cordon flexible externe de ce luminaire est endommagé, il doit être remplacé exclusivement par le fabricant ou son agent de service ou une personne qualifiée similaire afin d'éviter tout danger.
- Méthode de fixation du câble ou du cordon telle que tout remplacement ne peut être effectué que par le fabricant, son agent de service ou une personne qualifiée similaire.
- Utilisation en intérieur uniquement.



Ce marquage indique que ce produit ne doit pas être éliminé avec les autres déchets ménagers.



Attention, risque de choc électrique.

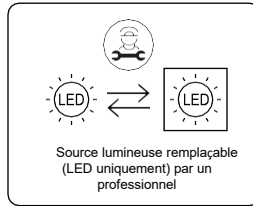

FR  
Cet appareil, ses accessoires et cordons se recyclent

À DÉPOSER EN MAGASIN

À DÉPOSER EN DÉCHÈTERIE



Points de collecte sur [www.quefairemedesdechets.fr](http://www.quefairemedesdechets.fr)  
Privilégiez la réparation ou le don de votre appareil !

## ATTENTION !

Ne pas regarder directement le faisceau lumineux de la LED. Le produit ne peut être alimenté que par la tension nominale ou la tension comprise dans la plage fournie. Il est interdit d'utiliser le produit avec une housse de protection endommagée. Le produit ne doit pas être utilisé dans des conditions défavorables, telles que la poussière, l'eau, l'humidité, les vibrations, les atmosphères explosives, les fumées ou les vapeurs chimiques, etc. Dans les zones de fortes interférences électromagnétiques, le fonctionnement du produit peut être perturbé.

## DIRECTIVES D'UTILISATION/ENTRETIEN

Toute opération d'entretien doit être effectuée lorsque l'alimentation électrique est coupée et que le produit a refroidi. Nettoyez uniquement avec des chiffons doux et secs. Ne pas utiliser de détergents chimiques. Ne pas couvrir le produit. Veillez à ce que l'air soit libre. Le produit peut atteindre une température plus élevée.

## MONTAGE

Lisez le manuel avant de procéder au montage. Le montage doit être effectué par un électricien qualifié. Soyez prudent. Le produit est doté d'un contact/terminal de protection. Le fait de ne pas connecter le fil de protection peut entraîner un choc électrique. Schéma de montage : voir les images. Vérifier le bon fonctionnement de la fixation et le raccordement au réseau électrique avant la première utilisation.

## SCHÉMA D'INSTALLATION DU PANNEAU DE SURFACE

### WIRING DIAGRAM

BROWN -- L --



BLUE -- N --

<p>1. couper le courant avant de commencer l'installation</p>	<p>2. confirmer la position d'installation du</p>	<p>3. percer un</p>
<p>4. insérer le boulon</p>	<p>5. fixer le support (inclus) au plafond à l'aide de vis.</p>	<p>6. Connecter le câblage selon le schéma de câblage</p>
<p>7. Fixer le panneau sur le support</p>	<p>8. Fixer la lumière et le support à l'aide de vis.</p>	<p>9. Mettez l'appareil sous tension et testez la lumière.</p>

## DIAGRAMME DE DÉMONTAGE

(Réservé à l'équipe de surveillance du marché)

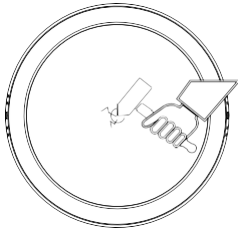

1. éteindre l'appareil, frapper la zone centrale de la plaque de diffusion à l'aide d'un outil pointu et retirer la plaque de diffusion fissurée

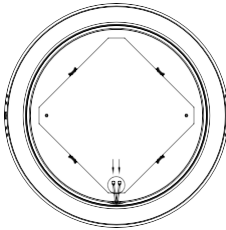

2. retirer le câble d'alimentation de la borne de la fiche

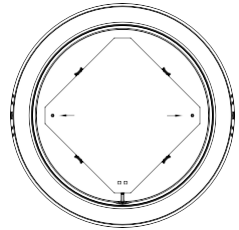

3. s'il n'y a pas de colonne thermofusible dans le corps de la lampe ou si la colonne thermofusible n'est pas thermofusible, cette étape sera ajustée. Si la colonne thermofusible a été fusionnée pour fixer le substrat en aluminium, couper la partie thermofusible de la pointe thermofusible à l'aide d'une pince diagonale.

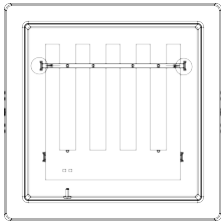

4. appuyez sur la boucle vers l'extérieur, retirez la bande de pression du substrat en aluminium de la balonnette et retirez la bande de pression. Cette étape n'est nécessaire que pour le panneau lumineux de 24W, les autres éléments ne sont pas nécessaires.

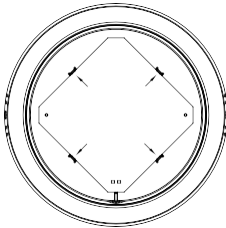

5. appuyez sur la boucle vers l'extérieur, retirez le substrat en aluminium de la boucle et retirez la carte de la source lumineuse.

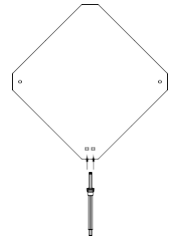

6. retirer le câble à deux brins (diamètre du fil 18-22AWG) et l'insérer dans la borne de connexion. Brancher l'alimentation externe pour les tests.

Note : Le retrait de la source lumineuse annule la garantie.

RoHS



UK  
CA



EN CAS DE QUESTION/PROBLÈME CONCERNANT LE PRODUIT, VEUILLEZ NOUS CONTACTER À L'ADRESSE SUIVANTE :  
SUPPORT@V-TAC.EU POUR PLUS D'INFORMATIONS SUR LA GAMME DE PRODUITS. VEUILLEZ CONTACTER NOTRE DISTRIBUTEUR  
OU LES REVENEURS LES PLUS PROCHES. V-TAC EUROPE LTD. BULGARIA, PLOVDIV 4000, BUL.L. KARAVELOW 9B

## GEBRAUCHSANWEISUNG

### LED-HINTERGRUNDBELEUCHTETE OBERFLÄCHENMONTIERTE PLATTE



#### TECHNISCHE DATEN

MODELL	SKU	SHAPE	WATTS	LUMENS	STRAHLENWINKEL	IP RATING	CRI	KÖRPER-TYP	GESAMT AKTUELL	EINGANGS SPANNUNG	LEBENS DAUER	EIN/AUS-ZYKLUS	ABMESSUNG (LxBxH)
VT-60006	104921,104911 104941 78701,78711 78721	RUND	6W	660Lm	Sphäre 360°	IP20	>80	KUNSTSTOFF	36mA	AC:220-240 50/60Hz	20000H	>15000	φ121.2x30.6mm
	SQUARE	120.8x120.8x30.7mm											
VT-60012	104951, 104961 104971 78731, 78741 78751	RUND	12W	1200Lm	Sphäre 360°	IP20	>80	KUNSTSTOFF	71mA	AC:220-240 50/60Hz	20000H	>15000	φ167.4x30.7mm
	SQUARE	167.3x167.3x30.7mm											
VT-60018	104981,104991 105001 78761,78771 78781	RUND	18W	1850Lm	Sphäre 360°	IP20	>80	KUNSTSTOFF	103mA	AC:220-240 50/60Hz	20000H	>15000	φ215.6x30.8mm
	SQUARE	1980Lm		214x214x31mm									
VT-60024	105141,105161 230231 78791,78801 78811	RUND	24W	2500Lm	Sphäre 360°	IP20	>80	KUNSTSTOFF	160mA	AC:220-240 50/60Hz	20000H	>15000	φ288.6x31.2mm
	SQUARE	2640Lm		285x285x30.7mm									

Dieses Produkt enthält eine Lichtquelle der Energieeffizienzklasse <F/E>“, wobei <F/E> durch die Energieeffizienzklasse der enthaltenen Lichtquelle zu ersetzen ist.

#### EINFÜHRUNG & GARANTIE

Vielen Dank, dass Sie ein V-TAC-Produkt ausgewählt und gekauft haben. V-TAC wird Ihnen die besten Dienste leisten. Bitte lesen Sie diese Anweisungen sorgfältig durch, bevor Sie mit der Installation beginnen, und bewahren Sie diese Anleitung zum späteren Nachschlagen auf. Sollten Sie weitere Fragen haben, wenden Sie sich bitte an unseren Händler oder an den lokalen Verkäufer, von dem Sie das Produkt gekauft haben. Sie sind geschult und bereit, Sie bestmöglich zu bedienen. Die Garantie gilt für 5 Jahre ab dem Kaufdatum. Die Garantie gilt nicht für Schäden, die durch unsachgemäße Installation oder abnormalen Verschleiß verursacht wurden. Das Unternehmen übernimmt keine Garantie für Schäden an Oberflächen, die durch unsachgemäßen Aus- und Einbau des Produkts entstehen. Die Produkte sind für einen täglichen Betrieb von 10-12 Stunden geeignet. Bei einer Nutzung des Produkts über 24 Stunden pro Tag erlischt die Garantie. Für dieses Produkt wird nur eine Garantie für Herstellungsfehler gewährt.

#### WARNUNG

- Bitte stellen Sie sicher, dass Sie den Strom abschalten, bevor Sie mit der Installation beginnen.
- Die Installation muss von einer zertifizierten Person durchgeführt werden.
- Wenn die äußere flexible Leitung oder das Kabel dieser Leuchte beschädigt ist, muss sie/es ausschließlich durch den Hersteller oder seinen Kundendienst oder eine ähnlich qualifizierte Person ersetzt werden, um eine Gefährdung zu vermeiden.
- Art der Befestigung des Kabels oder der Schnur, so dass ein Austausch nur durch den Hersteller, seinen Kundendienst oder eine ähnlich qualifizierte Person erfolgen kann.
- Nur für Innenräume geeignet.





Diese Kennzeichnung weist darauf hin, dass dieses Produkt nicht mit anderen Haushaltsabfällen entsorgt werden darf.



Vorsicht, Gefahr eines Stromschlags.

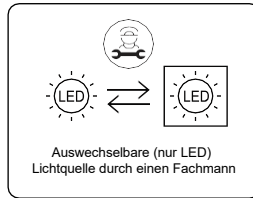

Points de collecte sur [www.quefairedemesdechets.fr](http://www.quefairedemesdechets.fr)  
Privilégiez la réparation ou le don de votre appareil !

## ACHTUNG!

Schauen Sie nicht direkt in den LED-Lichtstrahl. Das Produkt darf nur mit der Nennspannung oder einer Spannung innerhalb des angegebenen Bereichs betrieben werden. Es ist verboten, das Produkt mit beschädigter Schutzabdeckung zu verwenden. Das Produkt darf nicht unter ungünstigen Bedingungen verwendet werden, z.B. Staub, Wasser, Feuchtigkeit, Vibrationen, explosive Luft, Dämpfe oder chemische Dämpfe usw. Im Bereich starker elektromagnetischer Störungen kann die Funktion des Produkts gestört werden.

## NUTZUNGSRICHTLINIEN/WARTUNG

Alle Wartungsarbeiten dürfen nur bei ausgeschalteter Stromversorgung und abgeklümmtem Gerät durchgeführt werden. Reinigen Sie nur mit weichen und trockenen Tüchern. Verwenden Sie keine chemischen Reinigungsmittel. Decken Sie das Gerät nicht ab. Sorgen Sie für freien Luftzugang. Das Produkt kann sich auf eine höhere Temperatur erwärmen.

## MONTAGE

Lesen Sie vor der Montage das Handbuch. Die Montage sollte von einem qualifizierten Elektriker durchgeführt werden. Seien Sie vorsichtig. Das Produkt verfügt über einen Schutzkontakt/Klemme. Wird der Schutzkontakt nicht angeschlossen, besteht die Gefahr eines Stromschlags. Montageschema: siehe Bilder. Prüfen Sie, ob die mechanische Befestigung und Anschluss an das Stromnetz vor dem ersten Gebrauch.

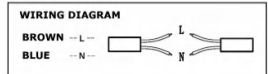

## INSTALLATIONSSCHEMA FÜR AUFPUTZPLATTEN

<p>1. schalten Sie die Stromversorgung aus, bevor</p>	<p>2. bestätigen Sie die Einbauposition der</p>	<p>3. ein Loch</p>
<p>4. den Spreizbolzen</p>	<p>5. befestigen Sie die Halterung (im</p>	<p>6. Schließen Sie die Verkabelung gemäß</p>
<p>7. Befestigen Sie die Platte an der Halterung.</p>	<p>8. Befestigen Sie die Leuchte und die Halterung mit Schrauben.</p>	<p>9. Schalten Sie den Strom ein und testen Sie das Licht.</p>

## DEMONTAGESKIZZE

(Nur für das Marktüberwachungsteam)

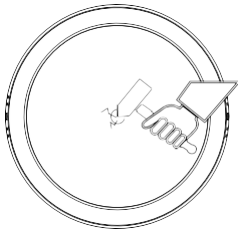

1. ausschalten, mit einem spitzen Werkzeug auf den mittleren Bereich der Verteilerplatte klopfen und die gerissene Verteilerplatte herausnehmen

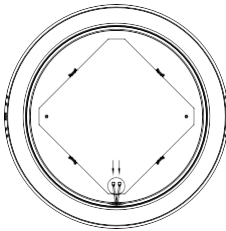

2. entfernen Sie das Stromkabel von der Steckklemme

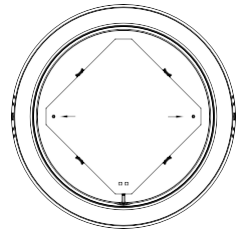

3. wenn es keine Heißschmelzsäule im Lampenkörper gibt oder die Heißschmelzsäule nicht heißschmelzend ist, wird dieser Schritt angepasst

Wenn die Schmelzklebstoffsäule zur Fixierung des Aluminiumsubstrats verschmolzen wurde, schneiden Sie den Schmelzklebstoffteil der Schmelzklebstoffspitze mit einer Schrägzange ab.

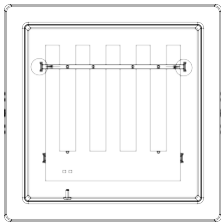

4. drücken Sie die Schnalle nach außen, entfernen Sie den Druckstreifen des Aluminiumsubstrats vom Bajonett und nehmen Sie den Druckstreifen ab. Dieser Schritt ist nur für 24W-Panel-Licht erforderlich, andere Elemente sind nicht erforderlich.

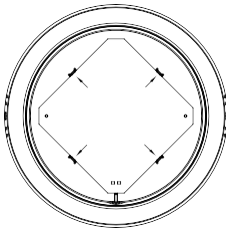

Drücken Sie die Schnalle nach außen, entfernen Sie das Aluminiumsubstrat von der Schnalle und nehmen Sie die Lichtquellenplatte ab.

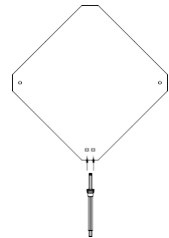

Nehmen Sie das zweidrähtige Kabel (Drahtdurchmesser 18-22AWG) heraus und stecken Sie es in die Steckklemme. Schließen Sie die externe Stromversorgung zum Testen an.

Hinweis: Die Entfernung der Lichtquelle führt zum Erlöschen der Garantie.

RoHS



UK  
CA



BEI FRAGEN/PROBLEMEN MIT DEM PRODUKT WENDEN SIE SICH BITTE AN UNS UNTER: SUPPORT@V-TAC.EU  
FÜR WEITERE PRODUKTE, ANFRAGEN WENDEN SIE SICH BITTE AN UNSEREN DISTRIBUTOR ODER DEN  
NÄCHSTGELEGENEN HÄNDLER. V-TAC EUROPE LTD. BULGARIEN, PLOVDIV 4000, BUL.L.KARAVELOW 9B

## ΕΓΧΕΙΡΙΔΙΟ ΟΔΗΓΙΩΝ

ΓΙΝΑΚΑΣ ΕΠΙΦΑΝΕΙΑΚΗΣ ΤΟΠΟΘΕΤΗΣΗΣ ΜΕ ΟΠΙΣΘΙΟ ΦΩΤΙΣΜΟ LED



### ΤΕΧΝΙΚΑ ΣΤΟΙΧΕΙΑ

ΜΟΝΤΕΛΟ	SKU	SHAPE	WATTS	LUMENS	ΓΩΝΙΑ ΔΕΞΙΜΗΣ	ΒΑΘΜΙ ΟΛΟΠΑ IP	CRI	ΤΥΠΟΣ ΣΩΜΑΤΟΣ	ΣΥΝΟΛΟ ΡΕΚΟΥΣΙΑ	ΤΑΞΗ ΕΙΣΟΔΟΥ	ΔΙΑΡΚΕΙΑ ΖΩΗΣ	ΚΥΚΛΟΣ ΕΝΕΡΓΟΠΟΙΗΣΗΣ/ΑΠΕΝΕΡΓ.	ΔΙΑΣΤΑΣΕΙΣ (LxWxH)
VT-60006	104921,104931 104941 78701,78711 78721	ΣΤΡΟΓΓΥΛΟ	6W	660Lm	Σφαίρα 360°	IP20	>80	ΠΛΑΣΤΙΚΟ	36mA	AC: 220-240 50/60Hz	20000H	>15000	φ121.2x30.6mm
		SQUARE											120.8x120.8x30.7mm
VT-60012	104891, 104961 104871 78731, 78741 78751	ΣΤΡΟΓΓΥΛΟΣ	12W	1200Lm	Σφαίρα 360°	IP20	>80	ΠΛΑΣΤΙΚΟ	71mA	AC: 220-240 50/60Hz	20000H	>15000	φ167.4x30.7mm
		SQUARE											167.3x167.3x30.7mm
VT-60018	104981,104991 105001 78761,78771 78781	ΣΤΡΟΓΓΥΛΟΣ	18W	1850Lm	Σφαίρα 360°	IP20	>80	ΠΛΑΣΤΙΚΟ	103mA	AC: 220-240 50/60Hz	20000H	>15000	φ215.6x30.8mm
		SQUARE		1980Lm									214x214x31mm
VT-60024	105141,105161 105021 78791,106021 78811	ΣΤΡΟΓΓΥΛΟΣ	24W	2500Lm	Σφαίρα 360°	IP20	>80	ΠΛΑΣΤΙΚΟ	160mA	AC: 220-240 50/60Hz	20000H	>15000	φ288.6x31.2mm
		SQUARE		2640Lm									285x285x30.7mm

"Αυτό το προϊόν περιέχει πηγή φωτός με κλάση ενεργειακής απόδοσης <F/E>", όπου το <F/E> αντικαθίσταται από την κλάση ενεργειακής απόδοσης της περιεχόμενης πηγής φωτός.

### ΕΙΣΑΓΩΓΗ & ΕΓΓΥΗΣΗ

Σας ευχαριστούμε που επιλέξατε και αγοράσατε το προϊόν V-TAC. Η V-TAC θα σας εξυπηρετήσει με τον καλύτερο τρόπο. Παρακαλούμε διαβάστε προσεκτικά αυτές τις οδηγίες πριν ξεκινήσετε την εγκατάσταση και κρατήστε αυτό το εγχειρίδιο για μελλοντική αναφορά. Εάν έχετε οποιαδήποτε άλλη απορία, παρακαλούμε επικοινωνήστε με τον αντιπρόσωπο μας ή τον τοπικό πωλητή από τον οποίο αγοράσατε το προϊόν. Είναι εκπαιδευμένοι και έτοιμοι να σας εξυπηρετήσουν με τον καλύτερο τρόπο. Η εγγύηση ισχύει για 5 χρόνια από την ημερομηνία αγοράς. Η εγγύηση δεν ισχύει για ζημιές που προκαλούνται από εσφαλμένη εγκατάσταση ή μη φυσιολογική φθορά. Η εταιρεία δεν παρέχει καμία εγγύηση για ζημιές σε οποιαδήποτε επιφάνεια λόγω λανθασμένης αφαίρεσης και εγκατάστασης του προϊόντος. Τα προϊόντα είναι κατάλληλα για 10-12 ώρες καθημερινής λειτουργίας. Η χρήση του προϊόντος για 24 ώρες την ημέρα θα ακυρώσει την εγγύηση. Αυτό το προϊόν φέρει εγγύηση μόνο για κατασκευαστικά ελαττώματα.

### ΠΡΟΕΙΔΟΠΟΙΗΣΗ

- Βεβαιωθείτε ότι έχετε απενεργοποιήσει το ρεύμα πριν ξεκινήσετε την εγκατάσταση.
- Η εγκατάσταση πρέπει να εκτελείται από πιστοποιημένο άτομο.
- Εάν το εξωτερικό εύκαμπτο καλώδιο ή το καλώδιο αυτού του φωτιστικού έχει υποστεί ζημιά, πρέπει να αντικαθίσταται αποκλειστικά από τον κατασκευαστή ή τον αντιπρόσωπο σέρβις του ή από παρόμοιο ειδικευμένο άτομο, προκειμένου να αποφευχθεί κίνδυνος.
- Μέθοδος στερέωσης του καλωδίου ή του κορδονιού, ώστε οποιαδήποτε αντικατάσταση να μπορεί να γίνει μόνο από τον κ α τ α σ κ ε υ α σ τ ή , τον αντιπρόσωπο σέρβις του ή παρόμοιο εξειδικευμένο άτομο.
- Μόνο για εσωτερική χρήση.



Η σήμανση αυτή υποδεικνύει ότι το προϊόν αυτό δεν πρέπει να απορρίπτεται μαζί με άλλα οικιακά απόβλητα.



Προσοχή, κίνδυνος ηλεκτροπληξίας.

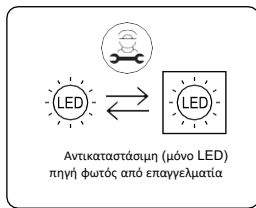

Points de collecte sur [www.quefairedemesdechets.fr](http://www.quefairedemesdechets.fr)  
Privilégiez la réparation ou le don de votre appareil !

## ΠΡΟΣΟΧΗ!

Μην κοιτάτε απευθείας την ακτίνα φωτός LED. Το προϊόν μπορεί να τροφοδοτηθεί μόνο με ονομαστική τάση ή τάση εντός του παρεχόμενου εύρους. Απαγορεύεται η χρήση του προϊόντος με κατεστραμμένο προστατευτικό κάλυμμα. Το προϊόν δεν πρέπει να χρησιμοποιείται σε δυσμενείς συνθήκες, π.χ. σκόνη, νερό, υγρασία, δονήσεις, εκρηκτική ατμόσφαιρα αέρα, αναθυμιάσεις ή χημικές αναθυμιάσεις κ.λπ. Σε περιοχή με ισχυρές ηλεκτρομαγνητικές παρεμβολές, ενδέχεται να διαταραχθεί η λειτουργία του προϊόντος.

## ΟΔΗΓΙΕΣ ΧΡΗΣΗΣ/ΣΥΝΤΗΡΗΣΗΣ

Οποιαδήποτε εργασία συντήρησης πρέπει να εκτελείται όταν έχει διακοπεί η παροχή ρεύματος και το προϊόν έχει κρυώσει. Καθαρίζετε μόνο με μαλακά και στεγνά πανιά. Μην χρησιμοποιείτε χημικά απορρυπαντικά. Μην καλύπτετε το προϊόν. Εξασφαλίστε ελεύθερη πρόσβαση στον αέρα. Το προϊόν ενδέχεται να θερμανθεί σε υψηλότερη θερμοκρασία.



## ΣΥΝΑΡΜΟΛΟΓΗΣΗ

Διαβάστε το εγχειρίδιο πριν από την τοποθέτηση. Η τοποθέτηση πρέπει να γίνεται από εξειδικευμένο ηλεκτρολόγο. Προσοχή. Το προϊόν διαθέτει προστατευτική επαφή / ακροδέκτη. Η μη σύνδεση του προστατευτικού καλωδίου μπορεί να οδηγήσει σε ηλεκτροπληξία. Διάγραμμα τοποθέτησης: βλέπε εικόνες. Ελέγξτε για τη σωστή μηχανική στερέωση και σύνδεση με την ηλεκτρική ενέργεια πριν από την πρώτη χρήση.

### WIRING DIAGRAM

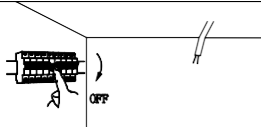
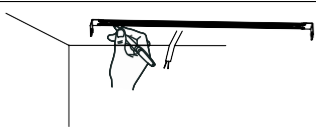
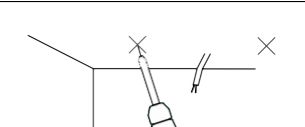
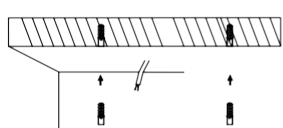
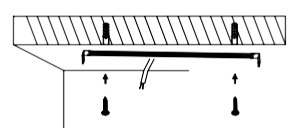
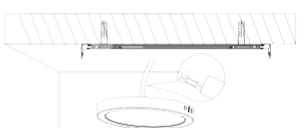
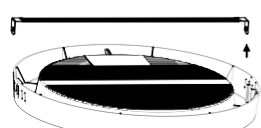

## ΔΙΑΓΡΑΜΜΑ ΕΓΚΑΤΑΣΤΑΣΗΣ ΕΠΙΦΑΝΕΙΑΚΟΥ ΠΙΝΑΚΑ

 <p>1. Απενεργοποιήστε την τροφοδοσία πριν ξεκινήσετε</p>	 <p>2. Επιβεβαιώστε τη θέση εγκατάστασης του</p>	 <p>3. Τρυπήστε</p>
 <p>4. Συνδέστε το μπουλόνι</p>	 <p>5. Στερεώστε το στήριγμα ( περιλαμβάνεται) στην</p>	 <p>6. Συνδέστε την καλωδίωση σύμφωνα με το διάγραμμα καλωδίωσης.</p>
 <p>7. Στερεώστε τον πίνακα στο στήριγμα.</p>	 <p>8. Στερεώστε το φως και το στήριγμα με βίδες.</p>	 <p>9. Ενεργοποιήστε το ρεύμα και δοκιμάστε το φως.</p>

## ΔΙΑΓΡΑΜΜΑ ΑΠΟΣΥΝΑΡΜΟΛΟΓΗΣΗΣ

(Μόνο για την ομάδα εποπτείας της αγοράς)

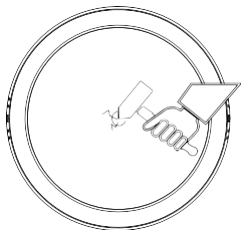

1. Απενεργοποιήστε, χτυπήστε την κεντρική περιοχή της πλάκας διάχυσης με ένα αιχμηρό εργαλείο και αφαιρέστε την ραγισμένη πλάκα διάχυσης.

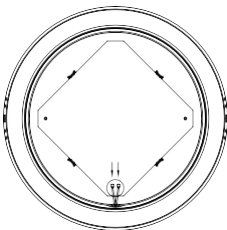

2. Αφαιρέστε το καλώδιο τροφοδοσίας από τον ακροδέκτη του βύσματος.

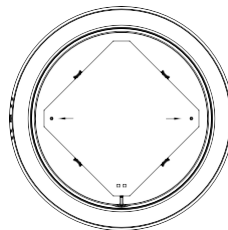

3. Εάν δεν υπάρχει στήλη θερμού τμήματος στο σώμα του λαμπτήρα ή η στήλη θερμού τμήματος δεν είναι ζεστό τμήμα, αυτό το βήμα θα ρυθμιστεί χωρίς επεξεργασία. Εάν η στήλη θερμής τήξης έχει λιώσει για να στερεώσει το υπόστρωμα αλουμινίου, κόψτε το τμήμα θερμής τήξης του σημείου θερμής τήξης με διαγώνια πένα.

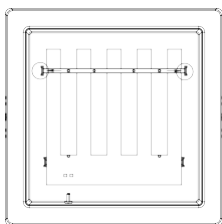

4. Πιέστε την πόρτη προς τα έξω, αφαιρέστε τη λωρίδα πίεσης του υποστρώματος αλουμινίου από τη μηχανιστά και αφαιρέστε τη λωρίδα πίεσης. Αυτό το βήμα απαιτείται μόνο για το φωτιστικό πίνακα 24W, άλλα στοιχεία δεν απαιτούνται.

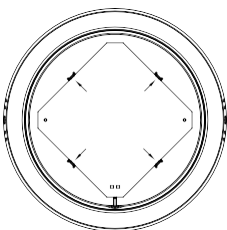

5. Πιέστε την πόρτη προς τα έξω, αφαιρέστε το υπόστρωμα αλουμινίου από την πόρτη και αφαιρέστε την πλακέτα της πηγής φωτός.

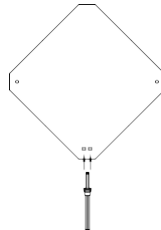

6. Θγάλετε το καλώδιο δύο κορδονιών (διάμετρος σώματος 18-22AWG) και τοποθετήστε το στον ακροδέκτη σύνδεσης. Συνδέστε την εξωτερική παροχή ρεύματος για δοκιμή.

Σημείωση: Η αφαίρεση της πηγής φωτός ακυρώνει την εγγύηση

RoHS



UK  
CA



ΣΕ ΠΕΡΙΠΤΩΧ ΟΠΟΙΟΥΔΗΠΟΤΕ ΕΡΩΤΗΜΑΤΟΣ/ΠΡΟΒΛΗΜΑΤΟΣ ΜΕ ΤΟ ΠΡΟΪΟΝ, ΠΑΡΑΚΑΛΟΥΜΕ ΕΠΙΚΟΙΝΩΝΗΣΤΕ ΜΑΖΙ ΜΑΣ ΣΤΟ: SUPPORT@V-TAC.EU ΓΙΑ ΠΕΡΙΣΣΟΤΕΡΗ ΣΕΙΡΑ ΠΡΟΪΟΝΤΩΝ, ΈΡΕΥΝΑ ΠΑΡΑΚΑΛΟΥΜΕ ΕΠΙΚΟΙΝΩΝΗΣΤΕ ΜΕ ΤΟΝ ΔΙΑΝΟΜΕΑ ΜΑΣ Η ΤΟΥΣ ΠΛΗΣΙΣΤΕΡΟΥΣ ΑΝΤΙΠΡΟΣΩΠΟΥΣ. V-TAC EUROPE LTD. ΒΟΥΛΓΑΡΙΑ, ΠΛΟΒΝΤΙΒ 4000, BUL.L.KARAVELLOW 9B

## HASZNÁLATI ÚTMUTATÓ

### LED HÁTTÉRVILÁGÍTÁSÚ FELÜLETRE SZERELT PANEL



**05** YEAR  
WARRANTY\*



**PRO**  
SERIES



#### TECHNIKAI ADATOK

MODELL	SKU	SHAPE	WATTS	LUMENS	SUGÁR SZÖGE	IP RATING	CRI	TEST TÍPUS	ÖSSZES ÁRAM	BEMEN ETI FESZÜLT SÉG	ÉLET SZAK ASZ	BE/KIKA PCSOLÁ SI CIKLUS	MÉRET (LxSxBxH)
VT-60006	104921,104931 104941 78701,78711 78721	KÖRKÉP	6W	660Lm	Gömb 360°	IP20	>80	PLASTIC	36mA	AC: 220-240 50/60Hz	20000H	>15000	φ121.2x30.6mm
		SQUARE											120.8x120.8x30.7mm
VT-60012	104951, 104961 104971 78731, 78741 78751	KÖRKÉP	12W	1200Lm	Gömb 360°	IP20	>80	MŰANY AG	71mA	AC: 220-240 50/60Hz	20000H	>15000	φ167.4x30.7mm
		SQUARE											167.3x167.3x30.7mm
VT-60018	104981, 104991 105001 78761, 78771 78781	KÖRKÉP	18W	1850Lm	Gömb 360°	IP20	>80	PLASTIC	103mA	AC: 220-240 50/60Hz	20000H	>15000	φ215.6x30.8mm
		SQUARE		1980Lm									214x214x31mm
VT-60024	105141,105161 230231 78791,78801 78811	KÖRKÉP	24W	2500Lm	Gömb 360°	IP20	>80	PLASTIC	160mA	AC: 220-240 50/60Hz	20000H	>15000	φ288.6x31.2mm
		SQUARE		2640Lm									285x285x30.7mm

"Ez a termék <F/E> energiahatékonysági osztályú fényforrást tartalmaz", ahol az <F/E> helyébe a termékben lévő fényforrás energiahatékonysági osztálya lép.

#### BEVEZETÉS ÉS GARANCIA

Köszönjük, hogy V-TAC terméket választott és vásárolt. A V-TAC a legjobbat fogja nyújtani Önnek. Kérjük, olvassa el figyelmesen ezeket az utasításokat, mielőtt elkezdi a telepítést, és tartsa kéznél ezt a kézikönyvet a későbbi használatra. Ha bármilyen más kérdése van, kérjük, forduljon a kereskedőnköz vagy a helyi forgalmazóhoz, akitől a terméket vásárolta. Ők képzettek és készen állnak arra, hogy a lehető legjobban kiszolgálják Önt. A garancia a vásárlástól számított 5 évig érvényes. A garancia nem vonatkozik a helytelen telepítés vagy rendellenes elhasználódás okozta károkra. A vállalat nem vállal garanciát a termék helytelen eltávolítása és beszerelése miatt bármely felületen keletkezett károokra. A termékek napi 10-12 órás működésre alkalmasak. A termék napi 24 órás használata esetén a garancia érvényét veszti. A termékre kizárólag gyártási hibák esetén vállalunk garanciát.

#### FIGYELMEZTETÉS

- A telepítés megkezdése előtt feltétlenül kapcsolja ki a készüléket.
- A beszerelést csak tanúsított személy végezheti.
- Ha a lámpatest külső hajlékony kábele vagy zsinórja megsérül, azt a veszély elkerülése érdekében kizárólag a gyártónak vagy szervizének, illetve hasonló képesítéssel rendelkező személynek kell kicserélnie.
- A kábel vagy zsinór rögzítésének módja, hogy a cserét csak a g y á r t ó , annak szervizügynöke vagy hasonló képesítéssel rendelkező személy végezze el.
- Csak beltéri használatra.



Ez a jelölés azt jelzi, hogy ezt a t e r m é k e t nem szabad más háztartási hulladékkal együtt ártalmatlanítani.



Vigyázat, áramütés veszélye.

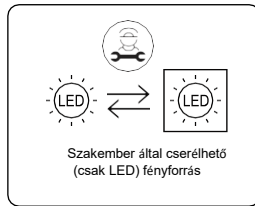

Points de collecte sur [www.guafairedemesdechets.fr](http://www.guafairedemesdechets.fr)  
Privilégiez la réparation ou le don de votre appareil !

## FIGYELEM!

Ne nézzen közvetlenül a LED fény sugarába. A termék csak névleges feszültséggel vagy a megadott tartományon belüli feszültséggel táplálható. Tilos a terméket sérült védőburkolattal használni. A terméket nem szabad kedvezőtlen körülmények között használni, pl. por, víz, nedvesség, rezgés, robbanásveszélyes légkör, füst vagy vegyi füst stb. esetén. Erős elektromágneses interferencia területén a termék működése megzavarható.

## HASZNÁLATI ÚTMUTATÓ/KARBANTARTÁS

Minden karbantartási munkát akkor kell elvégezni, amikor a tápellátás le van kapcsolva, és a termék lehűlt. Csak puha és száraz ruhával tisztítsa. Ne használjon kémiai tisztítószerket. Ne takarja le a terméket. Biztosítsa a szabad levegőhöz való hozzáférést. A termék magasabb hőmérsékletre melegedhet.

## FELSZERELÉS

A felszerelés előtt olvassa el a kézikönyvet. A szerelést szakképzett villanyszerelőnek kell elvégeznie. Legyen óvatos. A termék védőérintkezővel / végződéssel rendelkezik. A védővezeték csatlakoztatásának elmulasztása áramütéshez vezethet. Szerelési ábra: lásd a képeket. Ellenőrizze a megfelelő mechanikát az első használat előtt rögzítés és az elektromos hálózathoz való csatlakoztatás.

## FELSZÍNI PANEL SZERELÉSI DIAGRAM

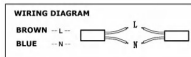

<p>1. Kapcsolja ki a készüléket a telepítés megkezdése előtt.</p>	<p>2. Erősítse meg a konzol beépítési helyzetét</p>	<p>3. Fúrjon egy</p>
<p>4. Dugja be a táglalási</p>	<p>5. Rögzítse a konzolt ( tartozék) a mennyezetre</p>	<p>6. Csatlakoztassa a vezetékeket a</p>
<p>7. Rögzítse a panelt a konzolra.</p>	<p>8. Rögzítse a lámpát és a konzolt csavarokkal.</p>	<p>9. Kapcsolja be a készüléket, és tesztelje a</p>

## SZÉTSZERELÉSI DIAGRAM

(Csak a piacfelügyeleti csoport számára)

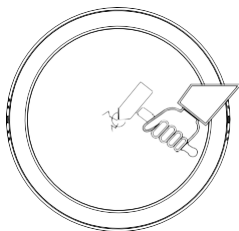

1. Kapcsolja ki, érintse meg a diffúziós lemez központi területét egy hegyes szerszámmal, és vegye ki a repedt diffúziós lemezt.

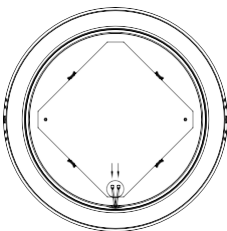

2. Távolítsa el a tápkábelt a dugaszoló csatlakozóból.

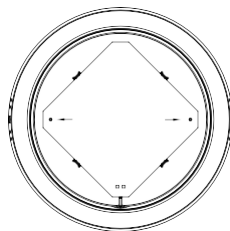

3. Ha nincs forró olvadék oszlop a lámpatestben, vagy a forró olvadék oszlop nem forró olvadék, ezt a lépést be kell állítani.  
kezelés nélkül. Ha a forróolvadék-oszlopot az alumínium aljzat rögzítéséhez olvasztották, vágja le a forróolvadék-pont forróolvadék-részt átlós fogóval.

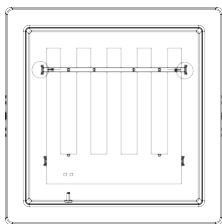

4. Nyomja kifelé a csatot, távolítsa el az alumínium aljzat nyomócsikját a bajonettől, és vegye le a nyomócsikot. Ez a lépés csak a 24 W-os panelfényhez szükséges, más elemekre nincs szükség.

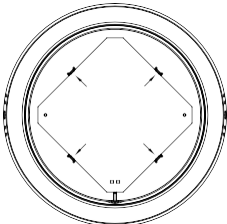

5. Nyomja kifelé a csatot, távolítsa el az alumínium hordozót a csatról, és vegye ki a fényforrás lapot.

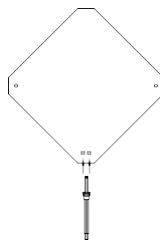

6. Vegye ki a kétsínűs kábelt (vezetékátmérő 18-22AWG), és helyezze be a dugaszolható terminálba. Csatlakoztassa a külső tápegységet a teszteléshez.

Megjegyzés: A fényforrás eltávolítása érvényteleníti a garanciát



A TERMÉKKEL KAPCSOLATOS BÁRMILYEN KÉRDÉS/PROBLÉMA ESETÉN KÉRJÜK, FORDULJON HOZZÁNK A KÖVETKEZŐ CIMEN:  
SUPPORT@V-TAC.EU TOVÁBBI TERMÉKVÁLASZTÉKÉRT, ÉRDEKLŐDÉSÉRT KÉRJÜK, LÉPJEN KAPCSOLATBA FORGALMAZÓNKKAL VAGY  
A LEGKÖZELEBBI KERESKEDŐINKKEL. V-TAC EUROPE LTD. BULGÁRIA, PLOVDIV 4000, BUL.L.KARAVELOW 9B



## MANUALE DI ISTRUZIONI

### PANNELLO RETROILLUMINATO A LED MONTATO IN SUPERFICIE



#### DATI TECNICI

MODELLO	SKU	FORMA	WATTS	LUMENS	ANGOL O DEL RAGGIO	VALU TAZIONE P	CRI	TIPO DI CORPO	TOTALE CORRENTE	TENSIONE D'INGRESS O	DURA TA DELLA VITA	CICLO ON/OFF	DIMENSIONE (LxLxH)
VT-60006	104921,104931 104941 78701,78711 78721	TONDO	6W	660Lm	Sfera a 360°	IP20	>80	PLASTICA	36mA	CA: 220-240 50/60Hz	20000H	>15000	φ121,2x30,6 mm
	PIAZZA	120,8x120,8x30,7 mm											
VT-60012	104951, 104961 104971 78731, 78741 78751	TONDO	12W	1200Lm	Sfera a 360°	IP20	>80	PLASTICA	71mA	CA: 220-240 50/60Hz	20000H	>15000	φ167,4x30,7 mm
	PIAZZA	167,3x167,3x30,7 mm											
VT-60018	104981,104991 105001 78761,78771 78781	TONDO	18W	1850Lm	Sfera a 360°	IP20	>80	PLASTICA	103mA	CA: 220-240 50/60Hz	20000H	>15000	φ215,6x30,8 mm
	PIAZZA	1980Lm		214x214x31,2 mm									
VT-60024	105141,105161 230231 78791,78801 78811	TONDO	24W	2500Lm	Sfera a 360°	IP20	>80	PLASTICA	160mA	CA: 220-240 50/60Hz	20000H	>15000	φ288,6x31,2 mm
	PIAZZA	2640Lm		285x285x30,7 mm									

Questo prodotto contiene una sorgente luminosa di classe di efficienza energetica <F/E>, dove <F/E> è sostituito dalla classe di efficienza energetica della sorgente luminosa contenuta.

#### INTRODUZIONE E GARANZIA

Grazie per aver scelto e acquistato un prodotto V-TAC. V-TAC vi servirà al meglio. Leggere attentamente le istruzioni prima di iniziare l'installazione e tenere il manuale a portata di mano per future consultazioni. Per qualsiasi altra domanda, contattare il nostro rivenditore o il venditore locale presso il quale è stato acquistato il prodotto. Sono addestrati e pronti a servirvi al meglio. La garanzia è valida per 5 anni dalla data di acquisto. La garanzia non si applica ai danni causati da un'installazione non corretta o da un'usura anomala. L'azienda non fornisce alcuna garanzia contro i danni a qualsiasi superficie dovuti a un'errata rimozione e installazione del prodotto. I prodotti sono adatti per un funzionamento di 10-12 ore al giorno. L'utilizzo del prodotto per 24 ore al giorno invalida la garanzia. Questo prodotto è garantito solo per i difetti di fabbricazione.

#### ATTENZIONE

- Assicurarsi di spegnere l'alimentazione prima di iniziare l'installazione.
- L'installazione deve essere eseguita da una persona certificata.
- Se il cavo flessibile esterno o il cavo di questo apparecchio è danneggiato, deve essere sostituito esclusivamente dal produttore o dal suo agente di assistenza o da una persona qualificata analoga, al fine di evitare un pericolo.
- Metodo di fissaggio del cavo o del cavo tale che la sostituzione possa essere effettuata solo dal p r o d u t t o r e , dal suo agente di assistenza o da una persona qualificata.
- Solo per uso interno.



Questo marchio indica che questo prodotto non deve essere smaltito con altri rifiuti domestici.



Attenzione, rischio di scosse elettriche.

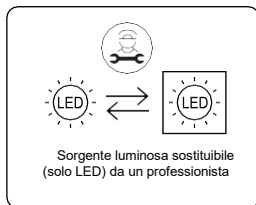

Points de collecte sur [www.quefairemedesdechets.fr](http://www.quefairemedesdechets.fr)  
Privilégiez la réparation ou le don de votre appareil !

## ATTENZIONE!

Non guardare direttamente il fascio di luce dei LED. Il prodotto può essere alimentato solo con la tensione nominale o con una tensione compresa nell' intervallo previsto. È vietato utilizzare il prodotto con il coperchio protettivo danneggiato. Il prodotto non deve essere utilizzato in condizioni sfavorevoli, ad esempio polvere, acqua, umidità, vibrazioni, atmosfera esplosiva, fumi o esalazioni chimiche, ecc. In presenza di forti interferenze elettromagnetiche, il funzionamento del prodotto potrebbe essere disturbato.

## LINEE GUIDA D'USO/MANUTENZIONE

Qualsiasi intervento di manutenzione deve essere eseguito quando l'alimentazione è interrotta e il prodotto si è raffreddato. Pulire solo con panni morbidi e asciutti. Non utilizzare detergenti chimici. Non coprire il prodotto. Assicurare il libero accesso all'aria. Il prodotto potrebbe riscaldarsi a una temperatura più elevata.

## MONTAGGIO

Leggere il manuale prima del montaggio. Il montaggio deve essere eseguito da un elettricista qualificato. Prestare attenzione. Il prodotto è dotato di un contatto/terminale di protezione. Il mancato collegamento del cavo di protezione può provocare scosse elettriche. Schema di montaggio: vedere le immagini. Verificare la correttezza meccanica

fissaggio e collegamento all'alimentazione elettrica prima del primo utilizzo.

## SCHEMA DI INSTALLAZIONE DEL PANNELLO DI SUPERFICIE

### WIRING DIAGRAM

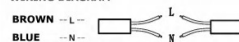

<p>1. Spegner il sistema prima di iniziare l'installazione.</p>	<p>2. Confermare la posizione di</p>	<p>3. Praticare</p>
<p>4. Inserire il bullone di</p>	<p>5. Fissare la staffa (inclusa) al soffitto con le viti.</p>	<p>6. Collegare il cablaggio come da schema elettrico.</p>
<p>7. Fissare il pannello sulla staffa.</p>	<p>8. Fissare la luce e la staffa con le viti.</p>	<p>9. Accendere l'alimentazione e testare la luce.</p>

## SCHEMA DI SMONTAGGIO

(Solo per il team di sorveglianza del mercato)

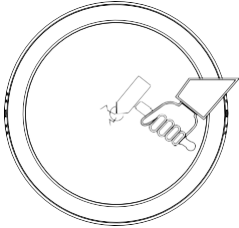
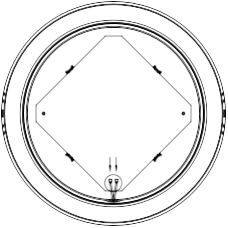
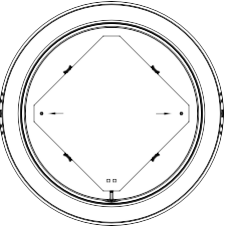
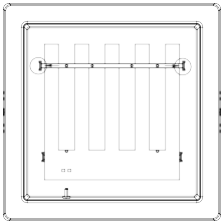
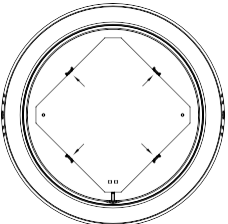
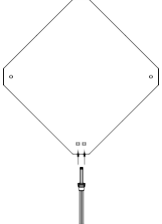
 <p>1. Spegner, toccare l'area centrale della piastra di diffusione con uno strumento appuntito ed estrarre la piastra di diffusione incrinata.</p>	 <p>2. Rimuovere il cavo di alimentazione dal terminale a spina.</p>	 <p>3. Se non c'è una colonna di fusione a caldo nel corpo della lampada o se la colonna di fusione a caldo non è calda, questa fase verrà regolata. Se la colonna hot-melt è stata fusa per fissare il substrato di alluminio, tagliare la parte hot-melt del punto hot-melt con una pinza diagonale.</p>
 <p>4. Premere la fibbia verso l'esterno, rimuovere la striscia di pressione del substrato di alluminio dalla baionetta e rimuovere la striscia di pressione. Questo passaggio è necessario solo per la lampada a pannello da 24W, mentre gli altri elementi non sono necessari.</p>	 <p>5. Premere la fibbia verso l'esterno, rimuovere il substrato di alluminio dalla fibbia e rimuovere la scheda della sorgente luminosa.</p>	 <p>6. Estrarre il cavo a due conduttori (diametro del filo 18-22AWG) e inserirlo nel terminale a innesto. Collegare l'alimentazione esterna per il test.</p>

Nota: la rimozione della sorgente luminosa invalida la garanzia

RoHS



UK  
CA



IN CASO DI DOMANDE/PROBLEMI CON IL PRODOTTO, CONTATTATECI ALL'INDIRIZZO: SUPPORT@V-TAC.EU PER ULTERIORI INFORMAZIONI SULLA GAMMA DI PRODOTTI, SI PREGA DI CONTATTARE IL NOSTRO DISTRIBUTORE O IL RIVENDITORE PIÙ VICINO. V-TAC EUROPE LTD. BULGARIA, PLOVDIV 4000, BUL.L.KARAVELOW 9B

## INSTRUKCJA OBSŁUGI

### PODŚWIETLANY PANEL LED DO MONTAŻU POWIERZCHNIOWEGO



**05** YEAR  
WARRANTY\*



**PRO**  
SERIES



#### DANE TECHNICZNE

MODEL	SKU	KSZTAŁT	WATTS	LUMENY	KĄT WIĄZKI	IP RATING	CRI	TYP NADWOZIA	BIEŻĄCE OGOŁEM	NAPIĘCIE WEJŚCIOWE	ROZPIĘTOŚĆ ŻYCIA	CYKL WŁĄCZANIA/WYŁĄCZANIA	WYMIARY (dł. x szer. x wys.)
VT-60006	104912,104911	RUNDA	6W	660 lm	Sfera 360	IP20	>80	PLASTIK	36mA	AC:220-240 50/60Hz	20000H	>15000	φ121,2x30,6 mm
	104941 78701,78711 78721	KWADRAT											120,8x120,8x30,7 mm
VT-60012	104951, 104961	RUNDA	12W	1200 lm	Sfera 360	IP20	>80	PLASTIK	71mA	AC:220-240 50/60Hz	20000H	>15000	φ167,4x30,7 mm
	104971 78731, 78741 78751	KWADRAT											167,3x167,3x30,7 mm
VT-60018	104981,104991	RUNDA	18W	1850Lm	Sfera 360	IP20	>80	PLASTIK	103mA	AC:220-240 50/60Hz	20000H	>15000	φ215,6x30,8 mm
	105001 78761,78771 78781	KWADRAT		1980Lm									214x214x31mm
VT-60024	105141,105161	RUNDA	24W	2500 lm	Sfera 360	IP20	>80	PLASTIK	160mA	AC:220-240 50/60Hz	20000H	>15000	φ288,6x31,2 mm
	105231 78791,78801 78811	KWADRAT		2640Lm									285x285x30,7mm

"Ten produkt zawiera źródło światła o klasie efektywności energetycznej <F/E>", gdzie <F/E> zastępuje się klasą efektywności energetycznej źródła światła.

#### WPROWADZENIE I GWARANCJA

Dziękujemy za wybranie i zakup produktu V-TAC. Firma V-TAC będzie służyć jak najlepiej. Przed rozpoczęciem instalacji należy uważnie przeczytać niniejszą instrukcję i zachować ją do wykorzystania w przyszłości. W przypadku jakichkolwiek innych pytań prosimy o kontakt z naszym dealerem lub lokalnym sprzedawcą, od którego zakupiono produkt. Są oni przeszkoleni i gotowi do świadczenia usług na najwyższym poziomie. Gwarancja jest ważna przez 5 lat od daty zakupu. Gwarancja nie obejmuje uszkodzeń spowodowanych nieprawidłową instalacją lub nadmiernym zużyciem. Firma nie udziela gwarancji na uszkodzenia powierzchni spowodowane nieprawidłowym demontażem i montażem produktu. Produkty są odpowiedzialne do pracy przez 10-12 godzin dziennie. Używanie produktu przez 24 godziny na dobę spowoduje utratę gwarancji. Ten produkt jest objęty gwarancją wyłącznie na wady produkcyjne.

#### OSTRZEŻENIE

- Przed rozpoczęciem instalacji należy wyłączyć zasilanie.
- Instalacja musi być przeprowadzona przez certyfikowaną osobę.
- Jeśli zewnętrzny elastyczny kabel lub przewód tej oprawy oświetleniowej jest uszkodzony, powinien zostać wymieniony wyłącznie przez producenta lub jego przedstawiciela serwisowego lub podobną wykwalifikowaną osobę w celu uniknięcia zagrożenia.
- Sposób zamocowania kabla lub przewodu umożliwiający wymianę wyłącznie przez producenta, jego przedstawiciela serwisowego lub podobną wykwalifikowaną osobę.
- Tylko do użytku wewnątrz pomieszczeń.



To oznaczenie wskazuje, że tego produktu nie należy wyrzucać razem z innymi odpadami domowymi.



Uwaga, ryzyko porażenia prądem.

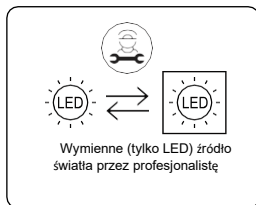

Points de collecte sur [www.quefairemedesdetches.fr](http://www.quefairemedesdetches.fr)  
Privilégiez la réparation ou le don de votre appareil !

## UWAGA!

Nie należy patrzeć bezpośrednio na wiązkę światła LED. Produkt może być zasilany wyłącznie napięciem znamionowym lub napięciem mieszczącym się w podanym zakresie. Zabrania się używania produktu z uszkodzoną osłoną ochronną. Produkt nie może być używany w niekorzystnych warunkach, np. kurz, woda, wilgoć, wibracje, wybuchowa atmosfera powietrza, opary lub opary chemiczne itp. W obszarze silnych zakłóceń elektromagnetycznych działanie produktu może zostać zakłócone.

## WYTYCZNE UŻYTKOWANIA/KONSERWACJA

Wszelkie prace konserwacyjne należy wykonywać po odłączeniu zasilania i ostygnięciu produktu. Urządzenie należy czyścić wyłącznie miękkimi i suchymi ściereczkami. Nie używaj chemicznych detergentów. Nie przykrywać produktu. Zapewnić swobodny dostęp powietrza. Produkt może rozgrzać się do wyższej temperatury.

## MONTAŻ

Przed montażem należy przeczytać instrukcję. Montaż powinien zostać przeprowadzony przez wykwalifikowanego elektryka. Należy zachować ostrożność. Produkt posiada styk/terminal ochrony. Niepodłączenie przewodu ochronnego może prowadzić do porażenia prądem. Schemat montażu: patrz ilustrację. Sprawdź poprawność mechaniczną

zamocowanie i podłączenie do zasilania elektrycznego przed pierwszym użyciem.

### WIRING DIAGRAM

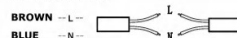

## SCHEMAT INSTALACJI PANELU POWIERZCHNIOWEGO

<p>1. Wyłącz zasilanie przed rozpoczęciem instalacji</p>	<p>2. Potwierdź pozycję montażową wspornika</p>	<p>3. Wywierć</p>
<p>4. Podłącz śrubę</p>	<p>5. Przymocuj wspornik (w zestawie) do sufitu za</p>	<p>6. Podłącz przewody zgodnie ze schematem.</p>
<p>7. Zamocuj panel na wsporniku.</p>	<p>8. Przymocuj lampę i wspornik za pomocą śrub.</p>	<p>9. Włącz zasilanie i przetestuj światło.</p>

## SCHEMAT DEMONTAŻU

(Tylko dla zespołu nadzoru rynku)

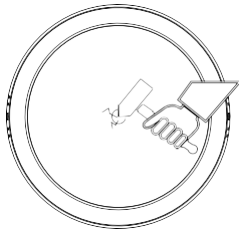

1. wyłączyć zasilanie, dotknij środkowego obszaru płyty dyfuzyjnej spiczastym narzędziem i wyjmij pękniętą płytę dyfuzyjną

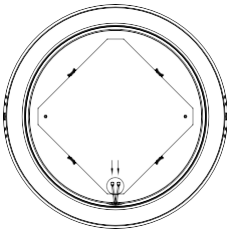

2. odłączyć przewód zasilający od zacisku wtykowego

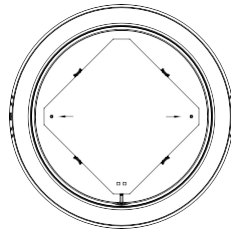

3. jeśli w korpusie lampy nie ma kolumny topliwiej lub kolumna topliwa nie jest topliwa, ten krok zostanie dostosowany  
Jeśli kolumna topliwa została stopiona w celu przymocowania do aluminiowego podłoża, odetnij część topliwą punktu topliwego za pomocą szczypiec ukośnych.

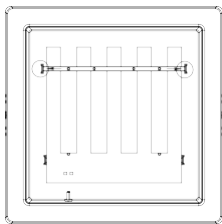

4. nacisnąć klamrę na zewnątrz, zdjęć aluminiowy pasek dociskowy podłoża z bagnetu i zdjęć pasek dociskowy. Ten krok jest wymagany tylko w przypadku oświetlenia panelowego 24 W, inne elementy nie są wymagane.

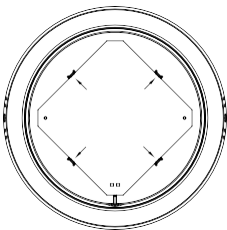

5. Naciśnij klamrę na zewnątrz, usuń aluminiowe podłoże z klamry i wyjmij płytkę źródła światła.

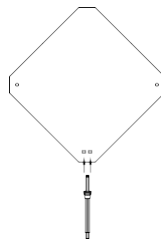

6. wyjąć przewód dwuwytłowy (średnica przewodu 18-22AWG) i włożyć go do zacisku wtykowego. Podłącz zewnętrzne zasilanie w celu przetestowania.

Uwaga: Usunięcie źródła światła spowoduje unieważnienie gwarancji.

RoHS



UK  
CA



W PRZYPADKU JAKICHKOLWIEK PYTAŃ/PROBLEMÓW Z PRODUKTEM, PROSIMY O KONTAKT POD ADRESEM: SUPPORT@V-TAC.EU. ABY UZYSKAĆ WIĘCEJ INFORMACJI, PROSIMY O KONTAKT Z NASZYM DYSTRYBUTOREM LUB NAJBLIŻSZYMI DEALERAMI. V-TAC EUROPE LTD. BULGARIA, PLOVDIV 4000, BUL.L.KARAVELOW 9B

## MANUAL DE INSTRUÇÕES

PAINEL DE MONTAGEM À SUPERFÍCIE COM RETROILUMINAÇÃO POR LED



**05** YEAR  
WARRANTY\*



**PRO**  
SERIES



### DADOS TÉCNICOS

MODELO	SKU	FORMA	ÁGUAS	LUMENS	ÂNGULO DO FEIXE	CLASSIFICAÇÃO IP	IRC	TIPO DE CORPO	TOTAL CORRENTE	TENSÃO DE ENTRADA	DURAÇÃO DA VIDA	CICLO ON/OFF	DIMENSÃO (CxLxA)
VT-60006	104901,104931 104941 78701,78711 78721	REDONDA	6W	660Lm	Esfera 360°	IP20	>80	PLÁSTICO	36mA	AC:220-240 50/60Hz	20000H	>15000	φ121.2x30.6mm
		QUADRADO											120,8x120,8x30,7mm
VT-60012	104951, 104961 104971 78731, 78741 78751	REDONDA	12W	1200Lm	Esfera 360°	IP20	>80	PLÁSTICO	71mA	AC:220-240 50/60Hz	20000H	>15000	φ167.4x30.7mm
		QUADRADO											167,3x167,3x30,7mm
VT-60018	104981,104991 105001 78761,78771 78781	REDONDA	18W	1850Lm	Esfera 360°	IP20	>80	PLÁSTICO	103mA	AC:220-240 50/60Hz	20000H	>15000	φ215.6x30.8mm
		QUADRADO		1980Lm									214x214x31mm
VT-60024	105141,105161 240211 78791,78801 78811	REDONDA	24W	2500Lm	Esfera 360°	IP20	>80	PLÁSTICO	160mA	AC:220-240 50/60Hz	20000H	>15000	φ288.6x31.2mm
		QUADRADO		2640Lm									285x285x30,7mm

"Este produto contém uma fonte luminosa da classe de eficiência energética <F/E>", em que <F/E> deve ser substituído pela classe de eficiência energética da fonte luminosa contida.

### INTRODUÇÃO E GARANTIA

Obrigado por selecionar e comprar o produto V-TAC. A V-TAC irá servi-lo da melhor forma. Por favor, leia atentamente estas instruções antes de iniciar a instalação e mantenha este manual à mão para referência futura. Se tiver qualquer outra dúvida, contacte o nosso revendedor ou o vendedor local a quem adquiriu o produto. Eles têm formação e estão prontos para o servir da melhor forma. A garantia é válida por 5 anos a partir da data de compra. A garantia não se aplica a danos causados por instalação incorrecta ou desgaste anormal. A empresa não dá qualquer garantia contra danos em qualquer superfície devido à remoção e instalação incorrectas do produto. Os produtos são adequados para um funcionamento diário de 10-12 horas. A utilização do produto durante 24 horas por dia anularia a garantia. Este produto tem garantia apenas para defeitos de fabrico.

### AVISO

- Certifique-se de que desliga a alimentação eléctrica antes de iniciar a instalação.
- A instalação deve ser efectuada por uma pessoa certificada.
- Se o cabo ou o cordão flexível externo dessa luminária estiver danificado, deve ser substituído exclusivamente pelo fabricante ou pelo seu agente de assistência ou por uma pessoa qualificada semelhante, de modo a evitar qualquer perigo.
- Método de fixação do cabo ou do cordão de modo a que qualquer substituição só possa ser efectuada pelo fabricante, pelo seu agente de assistência ou por uma pessoa qualificada semelhante.
- Apenas para utilização em interiores.



Esta marcação indica que este produto não deve ser eliminado juntamente com outros resíduos domésticos.



Cuidado, risco de choque elétrico.

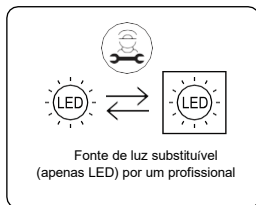

FR  
Cet appareil, ses accessoires et cordons se recycle

À DÉPOSER EN MAGASIN À DÉPOSER EN DÉCHÈTERIE



Points de collecte sur [www.quefairemedesdechets.fr](http://www.quefairemedesdechets.fr)  
Privilégiez la réparation ou le don de votre appareil !

## ATENÇÃO!

Não olhar diretamente para o feixe de luz LED. O produto só pode ser alimentado com a tensão nominal ou com a tensão dentro do intervalo previsto. É proibido utilizar o produto com a cobertura de proteção danificada. O produto não deve ser utilizado em condições desfavoráveis, por exemplo, poeira, água, humidade, vibrações, atmosfera explosiva, fumos ou vapores químicos, etc. Em áreas com fortes interferências electromagnéticas, o funcionamento do produto pode ser afetado.

## DIRETRIZES DE UTILIZAÇÃO/MANUTENÇÃO

Qualquer trabalho de manutenção deve ser efectuado quando a alimentação eléctrica estiver cortada e o produto tiver a r r e c i d o . Limpar apenas com panos macios e secos. Não utilizar detergentes químicos. Não cobrir o produto. Assegurar um acesso livre ao ar. O produto pode aquecer a uma temperatura mais elevada.

## MONTAGEM

Ler o manual antes de efetuar a montagem. A montagem deve ser efectuada por um electricista qualificado. Tenha cuidado. O produto tem um contacto/terminal de proteção. A não ligação do cabo de proteção pode provocar choques eléctricos. Esquema de montagem: ver imagens. Verificar se a montagem mecânica está correcta fixação e ligação à corrente eléctrica antes da primeira utilização.

### WIRING DIAGRAM

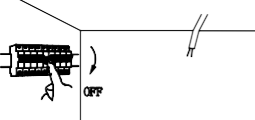
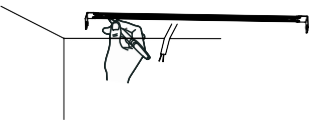
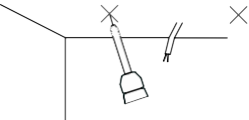
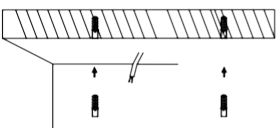
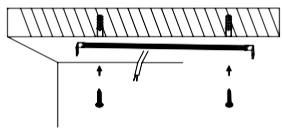
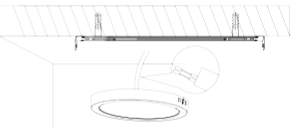
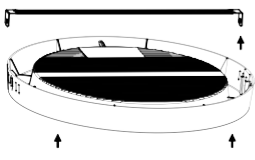
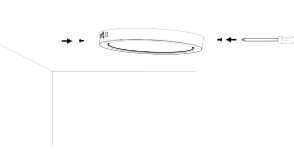
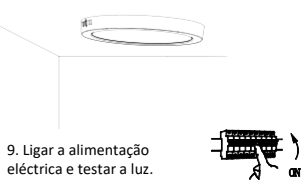

## ESQUEMA DE INSTALAÇÃO DO PAINEL DE SUPERFÍCIE

 <p>1. desligar a alimentação eléctrica antes de iniciar a</p>	 <p>2. confirmar a posição de instalação do suporte</p>	 <p>3. fazer um</p>
 <p>4. ligar o parafuso de</p>	 <p>5. fixar o suporte (incluído) no teto com parafusos.</p>	 <p>6. Ligar a cablagem de acordo com o esquema elétrico.</p>
 <p>7. Fixar o painel no suporte.</p>	 <p>8. Fixe a luz e o suporte com parafusos.</p>	 <p>9. Ligar a alimentação eléctrica e testar a luz.</p>



## DIAGRAMA DE DESMONTAGEM

(Apenas para a equipa de fiscalização do mercado)

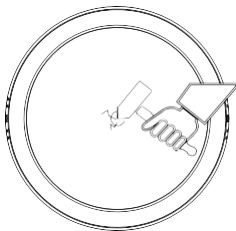
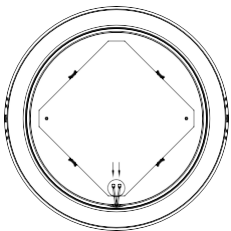
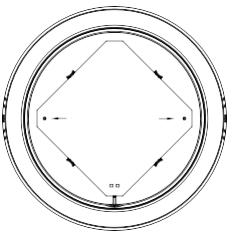
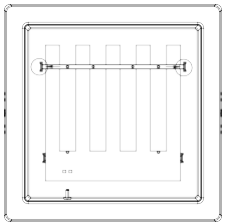
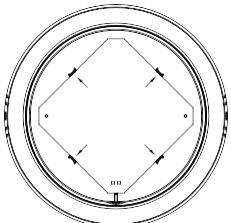
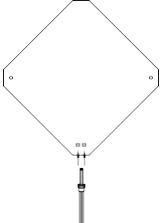
 <p>1. desligar a alimentação, bater na área central da placa de difusão com uma ferramenta pontiaguda e retirar a placa de difusão fissurada</p>	 <p>2. remover o fio de alimentação do terminal da ficha</p>	 <p>3. se não houver coluna de fusão a quente no corpo da lâmpada ou se a coluna de fusão a quente não for de fusão a quente, este passo será ajustado Se a coluna de fusão a quente tiver sido fundida para fixar o substrato de alumínio, cortar a parte de fusão a quente da ponta de fusão a quente com um alicate diagonal.</p>
 <p>4. pressionar a fivela para fora, remover a tira de pressão do substrato de alumínio da baioneta e remover a tira de pressão. Este passo só é necessário para o painel luminoso de 24 W, os outros itens não são necessários.</p>	 <p>5) Pressione a fivela para fora, retire o substrato de alumínio da fivela e retire a placa da fonte de luz.</p>	 <p>6. retirar o cabo de dois fios (diâmetro do fio 18-22AWG) e inseri-lo no terminal de encaixe. Ligar a fonte de alimentação externa para efetuar o teste.</p>

Nota: A remoção da fonte de luz anulará a garantia

RoHS



UK  
CA



EM CASO DE QUALQUER DÚVIDA/PROBLEMA COM O PRODUTO, CONTACTE-NOS ATRAVÉS DE: SUPPORT@V-TAC.EU. PARA OBTER MAIS INFORMAÇÕES SOBRE A GAMA DE PRODUTOS, CONTACTE O NOSSO DISTRIBUIDOR OU OS REVENDADORES MAIS PRÓXIMOS. V-TAC EUROPE LTD. BULGÁRIA, PLOVDIV 4000, BUL.L.KARAVELOW 9B

## MANUAL DE INSTRUCȚIUNI

PANOU MONTAT LA SUPRAFAȚĂ CU ILUMINARE DIN SPATE CU LED



**05** YEAR  
WARRANTY\*



**PRO**  
SERIES



### DATE TEHNICE

MODEL	SKU	FORMA	WATTS	LUMENI	UNGHIU L FASCICU LULUI	IP RATING	CRI	TIP DE CAROS ERIE	TOTAL CURRENT	TENSIUNE DE INTRARE	DURA TA DE VIATĂ	CICLUL ON/OFF	DIMENSIUNE (LxWxH)
VT-60006	104912,104911	ROUND	6W	660Lm	Sferă 360°	IP20	>80	PLASTIC	36mA	AC:220-240 50/60Hz	20000H	>15000	φ121.2x30.6mm
	104941 78701,78711 78721	SQUARE											120.8x120.8x30.7mm
VT-60012	104951, 104961	ROUND	12W	1200Lm	Sferă 360°	IP20	>80	PLASTIC	71mA	AC: 220-240 50/60Hz	20000H	>15000	φ167.4x30.7mm
	104971 78731, 78741 78751	SQUARE											167.3x167.3x30.7mm
VT-60018	104981,104991	ROUND	18W	1850Lm	Sferă 360°	IP20	>80	PLASTIC	103mA	AC:220-240 50/60Hz	20000H	>15000	φ215.6x30.8mm
	105001 78761,78771 78781	SQUARE		1980Lm									214x214x31mm
VT-60024	105141,105161	ROUND	24W	2500Lm	Sferă 360°	IP20	>80	PLASTIC	160mA	AC:220-240 50/60Hz	20000H	>15000	φ288.6x31.2mm
	105231 78791,78801 78811	SQUARE		2640Lm									285x285x30.7mm

"Acest produs conține o sursă de lumină din clasa de eficiență energetică <F/E>", unde <F/E> se înlocuiește cu clasa de eficiență energetică a sursei de lumină conținute.

### INTRODUCERE ȘI GARANȚIE

Vă mulțumim pentru selectarea și cumpărarea produsului V-TAC. V-TAC vă va oferi cele mai bune servicii. Vă rugăm să citiți cu atenție aceste instrucțiuni înainte de a începe instalarea și să păstrați acest manual la îndemână pentru consultare ulterioară. Dacă aveți orice altă întrebare, vă rugăm să contactați distribuitorul nostru sau vânzătorul local de la care ați achiziționat produsul. Aceștia sunt instruiți și pregătiți să vă servească la cel mai bun nivel. Garanția este valabilă timp de 5 ani de la data achiziției. Garanția nu se aplică daunelor cauzate de instalarea incorectă sau de uzura anormală. Compania nu oferă nicio garanție împotriva deteriorării oricărei suprafețe din cauza îndepărtării și instalării incorecte a produsului. Produsele sunt potrivite pentru o funcționare de 10-12 Ore pe zi. Utilizarea produsului timp de 24 de ore pe zi ar anula garanția. Acest produs este garantat numai pentru defectele de fabricație.

### AVERTISMENT

- Vă rugăm să vă asigurați că opriți alimentarea înainte de a începe instalarea.
- Instalarea trebuie să fie efectuată de o persoană certificată.
- În cazul în care cablul sau cablul flexibil extern al acestui corp de iluminat este deteriorat, acesta trebuie înlocuit exclusiv de producător sau de agentul său de service sau de o persoană calificată similară, pentru a evita un pericol.
- Metoda de fixare a cablului sau a cordonului astfel încât orice înlocuire să poată fi efectuată numai de către p r o d u c ă t o r , agentul său de service sau o persoană calificată similară.
- Numai pentru utilizare în interior.



Acest marcaj indică faptul că acest produs nu trebuie eliminat împreună cu alte deșeuri menajere.



Atenție, risc de electrocutare.

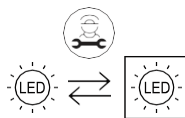

Sursă de lumină înlocuibilă (numai LED) de către un profesionist



FR

Cet appareil, ses accessoires et cordons se recyclent

À DÉPOSER EN MAGASIN

À DÉPOSER EN DÉCHÈTERIE



Points de collecte sur [www.quefairemesdechets.fr](http://www.quefairemesdechets.fr)  
Privilégiez la réparation ou le don de votre appareil !

## ATENȚIE!

Nu vă uitați direct la fasciculul de lumină LED. Produsul poate fi alimentat numai de tensiunea nominală sau de tensiunea din intervalul prevăzut. Este interzisă utilizarea produsului cu capacul de protecție deteriorat. Produsul nu trebuie utilizat în condiții nefavorabile, de exemplu, praf, apă, umiditate, vibrații, atmosferă cu aer exploziv, fumuri sau vapori chimici etc. În zona cu interferențe electromagnetice puternice, funcționarea produsului poate fi perturbată.

## INSTRUCȚIUNI DE UTILIZARE/ÎNTREȚINERE

Orice lucrare de întreținere trebuie efectuată după ce alimentarea cu energie electrică este întreruptă și produsul s-a răcit. Curățați numai cu cârpe moi și uscate. Nu utilizați detergenți chimici. Nu acoperiți produsul. Asigurați accesul liber la aer. Produsul se poate încălzi la o temperatură mai ridicată.

## MONTAJ

Citiți manualul înainte de montare. Montarea trebuie să fie efectuată de un electrician calificat. Aveți grijă. Produsul are un contact-terminal de protecție. Neconectarea contactului de protecție poate duce la soc electric. Schema de montare: consultați imaginea. Verificați dacă mecanica este corespunzătoare fixarea și conectarea la rețeaua electrică înainte de prima utilizare.

## DIAGRAMA DE INSTALARE A PANOULUI DE SUPRAFAȚĂ

### WIRING DIAGRAM

BROWN -- L --  
BLUE -- N --



<p>1. Opriti alimentarea înainte de a începe instalarea</p>	<p>2. Confirmați poziția de instalare a suportului</p>	<p>3. Faceți o</p>
<p>4. Introduceți șurubul de</p>	<p>5. Fixați suportul (inclusiv) pe tavan cu șuruburi.</p>	<p>9. Conectați cablajul conform schemei de cablare.</p>
<p>7. Fixați panoul pe suport.</p>	<p>8. Fixați lumina și suportul cu șuruburi.</p>	<p>9. Conectați alimentarea și testați lumina.</p>

## DIAGRAMA DE DEZASAMBLARE

(Numai pentru echipa de supraveghere a pieței)

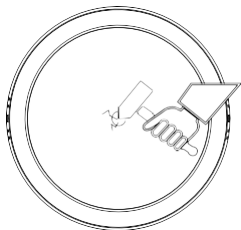

1. Opriti alimentarea, atingeți zona centrală a plăcii de difuzie cu un instrument ascuțit și scoateți placa de difuzie fisurată

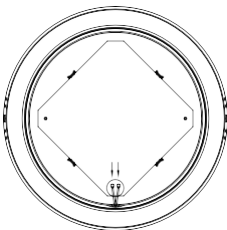

2. Îndepărtați firul de alimentare de la terminalul fișei

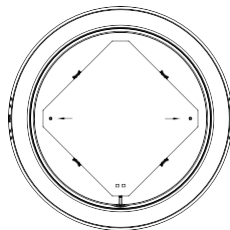

3. Dacă nu există coloană de topire la cald în corpul lămpii sau coloana de topire la cald nu este topită la cald, acest pas va fi ajustat fără tratament. Dacă coloana de topire la cald a fost topită pentru a fixa substratul de aluminiu, tăiați partea topită la cald a punctului de topire la cald cu un clește diagonal.

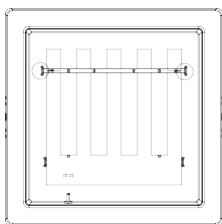

4. Apăsați catarama spre exterior, scoateți banda de presare a substratului de aluminiu din baloneta și scoateți banda de presare. Acest pas este necesar numai pentru panoul de lumină de 24W, alte elemente nu sunt necesare.

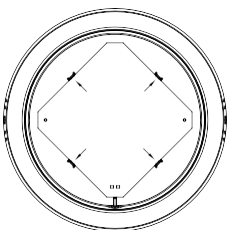

5. Apăsați catarama spre exterior, scoateți substratul de aluminiu din cataramă și scoateți placa sursei de lumină.

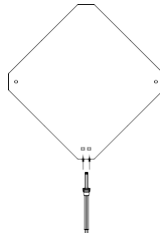

6. Scoateți cablul cu două fire (diametrul firului 18-22AWG) și introduceți-l în terminalul plug-in.  
7. Conectați sursa de alimentare externă pentru testare.

Notă: Îndepărtarea sursei de lumină va anula garanția

RoHS



UK  
CA



ÎN CAZUL ORICĂREI ÎNTREBĂRI/PROBLEME LEGATE DE PRODUS, VĂ RUGĂM SĂ NE CONTACTAȚI LA: SUPPORT@V-TAC.EU  
PENTRU O GAMĂ MAI LARGĂ DE PRODUSE, VĂ RUGĂM SĂ CONTACTAȚI DISTRIBUTORUL NOSTRU SAU CEI MAI APROPIAȚI DEALERI.  
V-TAC EUROPE LTD. BULGARIA, PLOVDIV 4000, BUL.L.KARAELOW 9B

## MANUAL DE INSTRUCCIONES

### PANEL DE SUPERFICIE RETROILUMINADO CON LEDS



**05** YEAR  
WARRANTY\*



**PRO**  
SERIES



### DATOS TÉCNICOS

MODELO	SKU	SHAPE	WATTS	LUMENS	ÁNGULO DEL HAZ	CLASIFICACION P	CRI	TIPO DE CARROCERIA	TOTAL CORRIENTE	TENSION DE ENTRADA	VIDA ÚTIL	CICLO ON/OFF	DIMENSIONES (LxAnxAI)
VT-60006	104941, 104993 104941 78701,78711 78721	RONDA	6W	660Lm	Esfera 360	IP20	>80	PLÁSTICO	36 mA	CA:220-240 50/60Hz	20000H	>15000	φ121,2x30,6mm
	CUADRADO	120,8x120,8x30,7 mm											
VT-60012	104951, 104961 104971 78731, 78741 78751	RONDA	12W	1200Lm	Esfera 360	IP20	>80	PLÁSTICO	71 mA	CA:220-240 50/60Hz	20000H	>15000	φ167,4x30,7mm
	CUADRADO	167,3x167,3x30,7mm											
VT-60018	104981, 104991 105001 78761,78771 78781	RONDA	18W	1850Lm	Esfera 360	IP20	>80	PLÁSTICO	103 mA	CA:220-240 50/60Hz	20000H	>15000	φ215,6x30,8mm
	CUADRADO	1980Lm		214x214x31mm									
VT-60024	105141, 105161 230231 78791,78801 78811	RONDA	24W	2500Lm	Esfera 360	IP20	>80	PLÁSTICO	160 mA	CA:220-240 50/60Hz	20000H	>15000	φ288,6x31,2mm
	CUADRADO	2640Lm		285x285x30,7mm									

Este producto contiene una fuente luminosa de clase de eficiencia energética <F/E>", donde <F/E> se sustituirá por la clase de eficiencia energética de la fuente luminosa contenida.

### INTRODUCCIÓN Y GARANTÍA

Gracias por seleccionar y comprar un producto V-TAC. V-TAC le servirá lo mejor posible. Lea atentamente estas instrucciones antes de comenzar la instalación y conserve este manual a mano para futuras consultas. Si tiene cualquier otra duda, póngase en contacto con nuestro distribuidor o vendedor local al que haya comprado el producto. Están formados y preparados para atenderle lo mejor posible. La garantía es válida durante 5 años a partir de la fecha de compra. La g a r a n t í a no se aplica a los daños causados por una instalación incorrecta o un desgaste anormal. La empresa no ofrece ninguna garantía contra daños en cualquier superficie debidos a una incorrecta retirada e instalación del producto. Los p r o d u c t o s son adecuados para un funcionamiento de 10-12 Horas diarias. El uso del producto durante 24 horas al día anularía la garantía. Este producto está garantizado únicamente por defectos de fabricación.

### ADVERTENCIA

- Asegúrese de desconectar la alimentación antes de iniciar la instalación.
- La instalación debe ser realizada por una persona certificada.
- Si el cable o cordón flexible externo de esta luminaria está dañado, deberá ser sustituido exclusivamente por el fabricante o su agente de servicio o una persona cualificada similar para evitar riesgos.
- Método de fijación del cable o cordón de forma que cualquier sustitución sólo pueda ser realizada por el fabricante, su agente de servicio o una persona cualificada similar.
- Sólo para uso en interiores.



Esta marca indica que este producto no debe eliminarse con otros residuos domésticos.



Precaución, riesgo de descarga eléctrica.

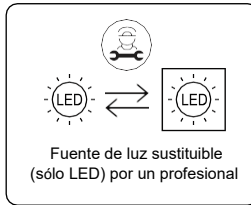

FR  
Cet appareil, ses accessoires et cordons se recyclent

À DÉPOSER EN MAGASIN

À DÉPOSER EN DÉCHÈTERIE



Points de collecte sur [www.quefairedemesdechets.fr](http://www.quefairedemesdechets.fr)  
Privilégiez la réparation ou le don de votre appareil !

## ATENCIÓN

No mire directamente al haz de luz LED. El producto sólo puede alimentarse con la tensión nominal o con la tensión dentro del rango previsto. Está prohibido utilizar el producto con la cubierta protectora dañada. El producto no debe utilizarse en condiciones desfavorables, como polvo, agua, humedad, vibraciones, atmósfera explosiva, humos o vapores químicos, etc. En zonas con fuertes interferencias electromagnéticas, el funcionamiento del producto puede verse afectado.

## NORMAS DE USO/MANTENIMIENTO

Cualquier trabajo de mantenimiento debe realizarse cuando la alimentación eléctrica esté cortada y el producto se haya enfriado. Limpie sólo con paños suaves y secos. No utilice detergentes químicos. No cubra el producto. Asegúrese de que haya libre acceso de aire. El producto puede calentarse a una temperatura más elevada.

## MONTAJE

Lea el manual antes del montaje. El montaje debe ser realizado por un electricista cualificado. Tenga cuidado. El producto tiene un contacto/terminal de protección. Si no se conecta el cable de protección, puede producirse una descarga eléctrica. Esquema de montaje: ver imágenes. Compruebe que la mecánica fijación y conexión a la red eléctrica antes del primer uso.

### WIRING DIAGRAM

BROWN -- L --

BLUE -- N --



## DIAGRAMA DE INSTALACIÓN DEL PANEL DE SUPERFICIE

<p>1. Desconecte la alimentación antes de iniciar la instalación.</p>	<p>2. Confirme la posición de instalación del soporte</p>	<p>3. Taladra un</p>
<p>4. Enchufe el perno de</p>	<p>5. Fije el soporte (incluido) en el techo con tornillos.</p>	<p>6. Conecte el cableado según el esquema eléctrico.</p>
<p>7. Fije el panel en el soporte.</p>	<p>8. Fije la luz y el soporte con tornillos.</p>	<p>9. Conecte el cableado según el esquema eléctrico.</p>

## DIAGRAMA DE DESMONTAJE

(Sólo para el equipo de vigilancia del mercado)

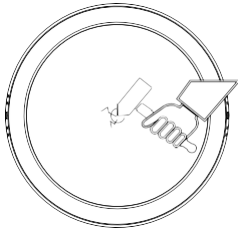

1. Apagar, golpear el área central de la placa de difusión con una herramienta puntiaguda y sacar la placa de difusión agrietada.

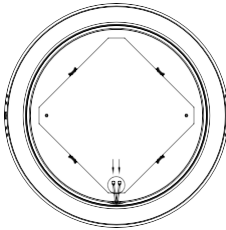

2. Retire el cable de alimentación del terminal de enchufe

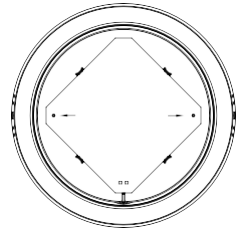

3. Si no hay columna de fusión caliente en el cuerpo de la lámpara o la columna de fusión caliente no es de fusión caliente, este paso se ajustará

Si la columna termofusible se ha fundido para fijar el sustrato de aluminio, corte la parte termofusible de la punta termofusible con unos alicates diagonales.

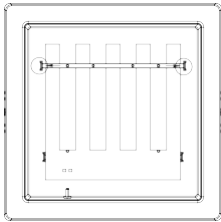

4. Presione la hebilla hacia fuera, retire la tira de prensado del sustrato de aluminio de la bayoneta y retire la tira de prensado. Este paso sólo es necesario para la luz del panel de 24W, otros elementos no son necesarios.

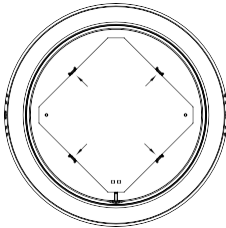

5. Presione la hebilla hacia fuera, retire el sustrato de aluminio de la hebilla y retire la placa de la fuente de luz.

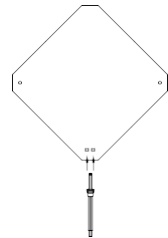

6. Saque el cable de dos hilos (diámetro 18-22AWG) e insértelo en el terminal enchufable. Conecte la fuente de alimentación externa para la prueba.

Nota: La eliminación de la fuente de luz anulará la garantía.

RoHS



UK  
CA



EN CASO DE CUALQUIER DUDA O PROBLEMA CON EL PRODUCTO, PÓNGASE EN CONTACTO CON NOSOTROS EN: SUPPORT@V-TAC.EU PARA MÁS GAMA DE PRODUCTOS, CONSULTA POR FAVOR PÓNGASE EN CONTACTO CON NUESTRO DISTRIBUIDOR O DISTRIBUIDORES MÁS CERCANOS. V-TAC EUROPE LTD. BULGARIA, PLOVDIV 4000, BUL.L.KARAVELOW 9B